

Параллельные прямые

Задачи на готовых чертежах

- Признаки параллельности прямых
- Свойства параллельных прямых

*Выполнила: Панова Вера
Александровна
Учитель математики
МБОУ СОШ № 201 «Согласие»
г. Екатеринбург*



Укажите номера рисунков, на которых изображены параллельные прямые

1

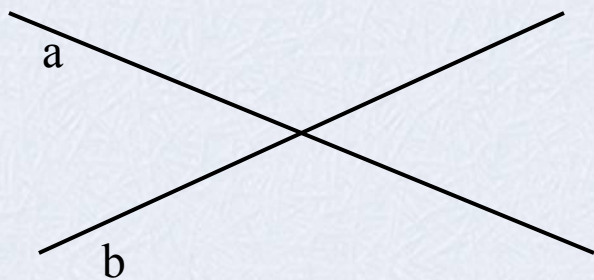

3

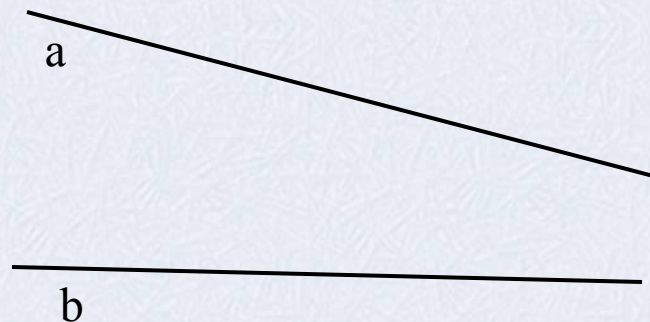

2

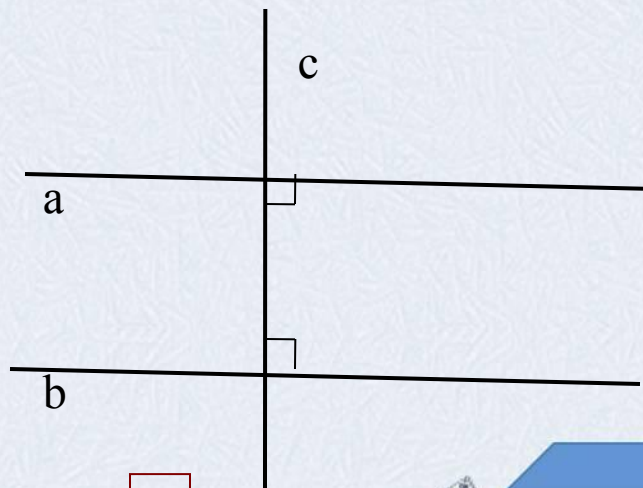

4

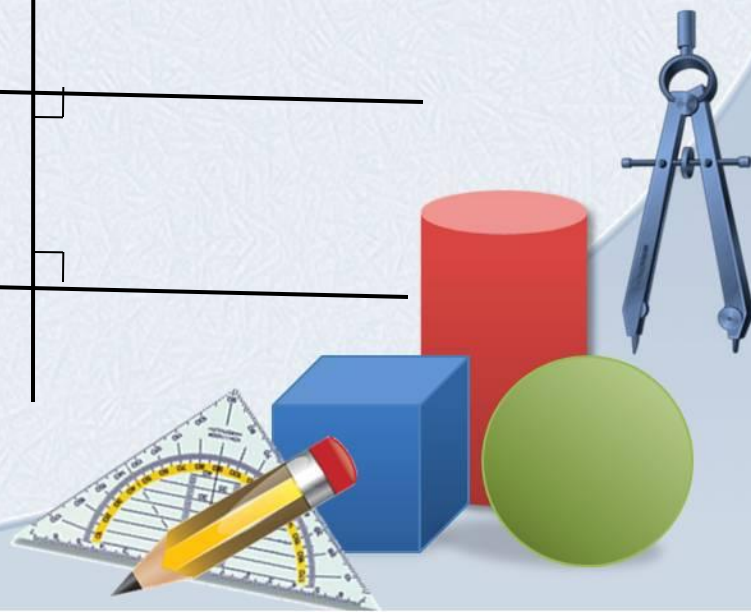

1. Назовите накрест лежащие углы при прямых a и b и секущей c .
2. Назовите односторонние углы при прямых b и c и секущей a .
3. Назовите соответственные углы при прямых a и c и секущей b .

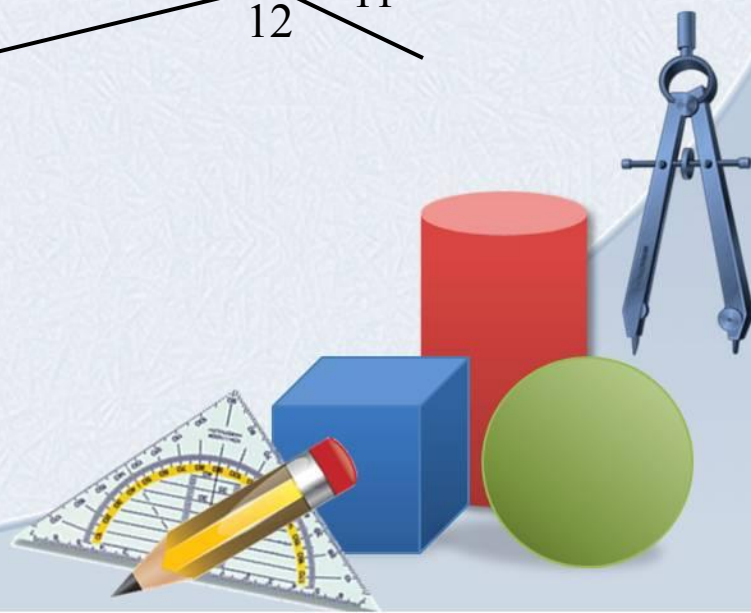
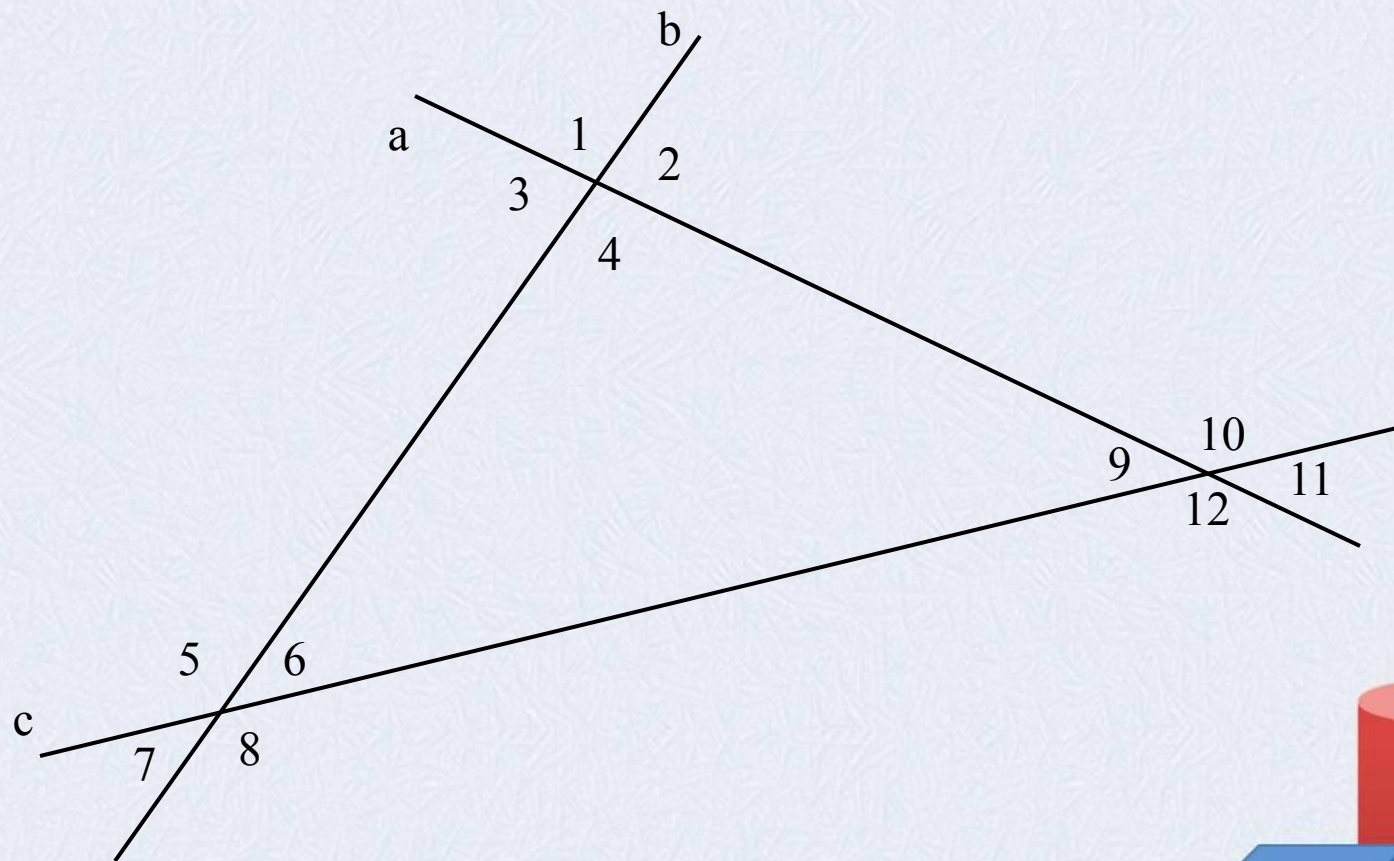

Дано: $\angle 1 = 32^\circ$, $\angle 2 = 32^\circ$

Доказать: $a \parallel b$.

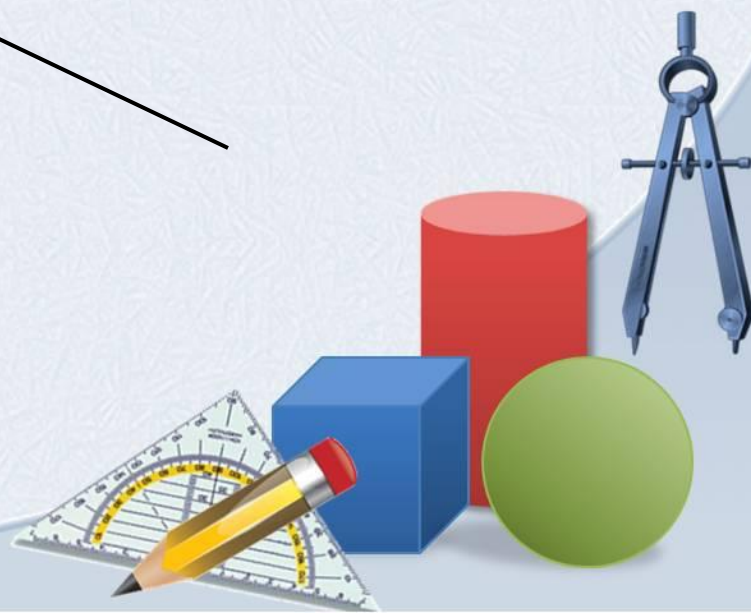
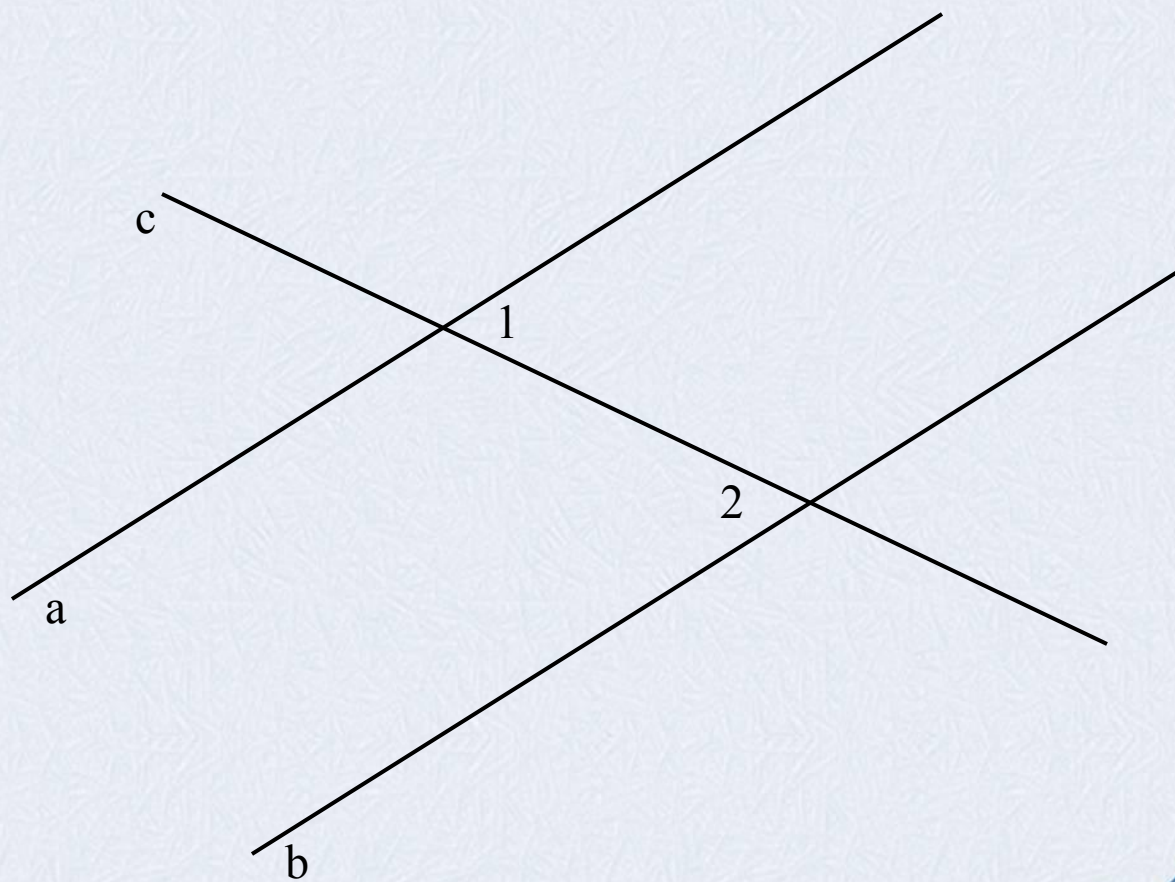

Дано: $\angle 1 = 48^\circ, \angle 2 = 132^\circ$

Доказать: $a \parallel b$.

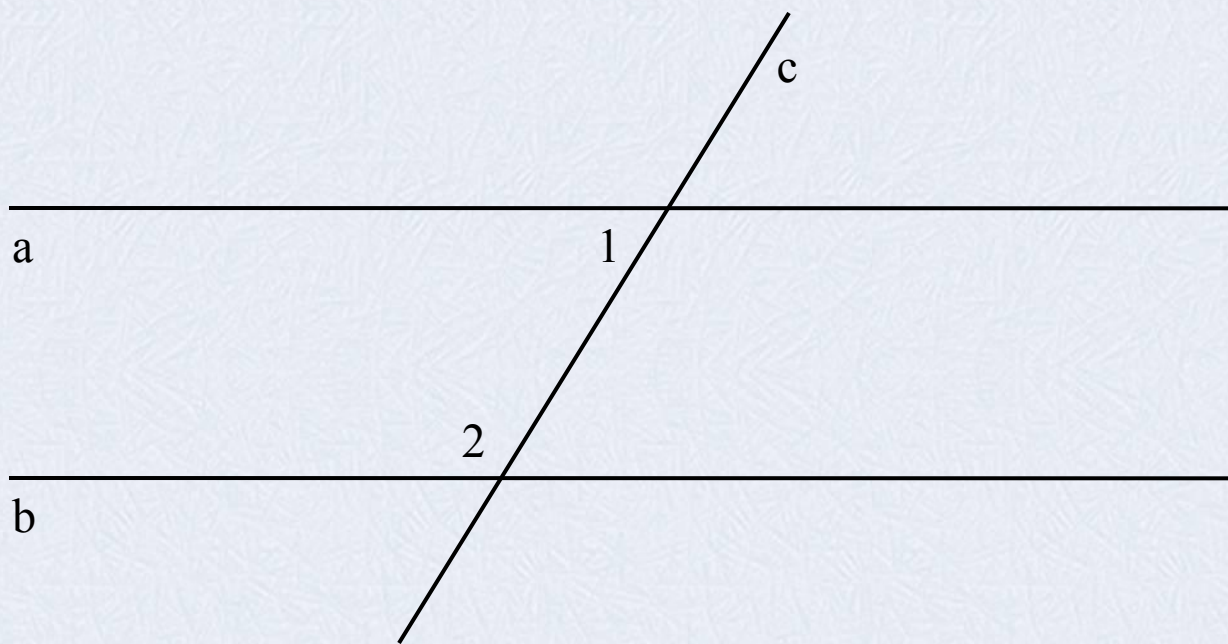

Дано: $\angle 1 = 47^\circ$, $\angle 2 = 133^\circ$

Доказать: $a \parallel b$.

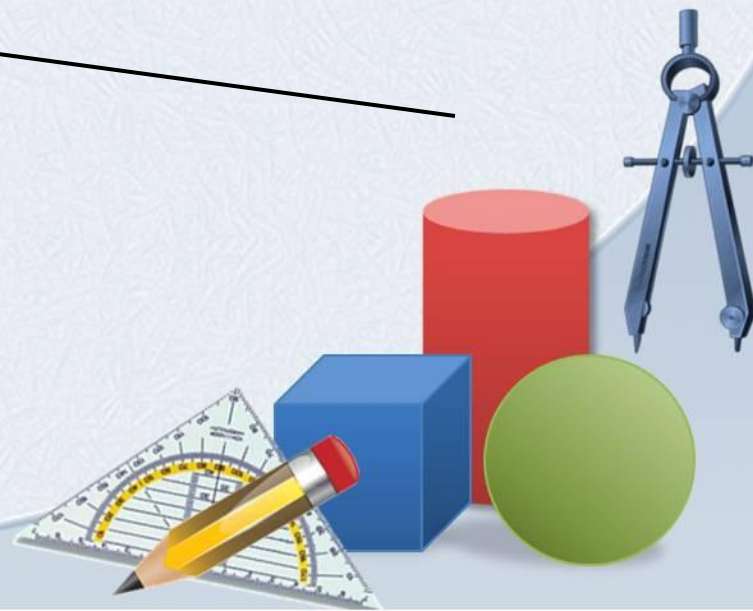
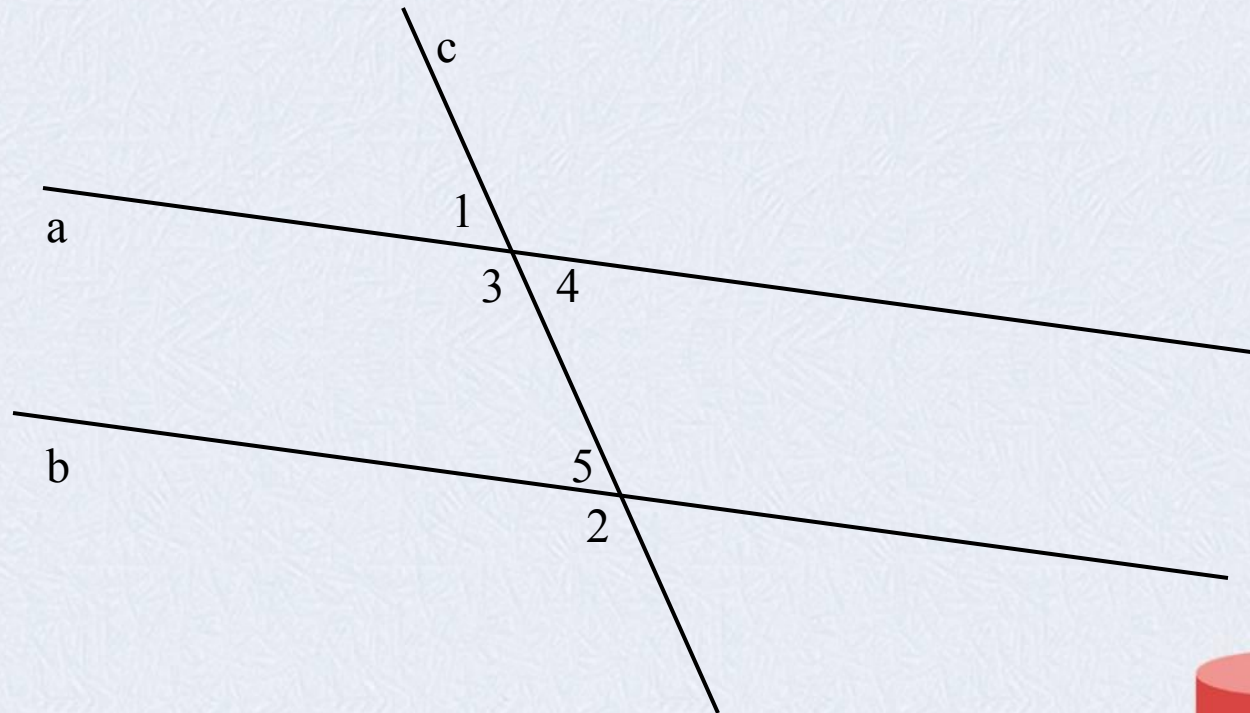

Параллельны ли прямые a и b ?

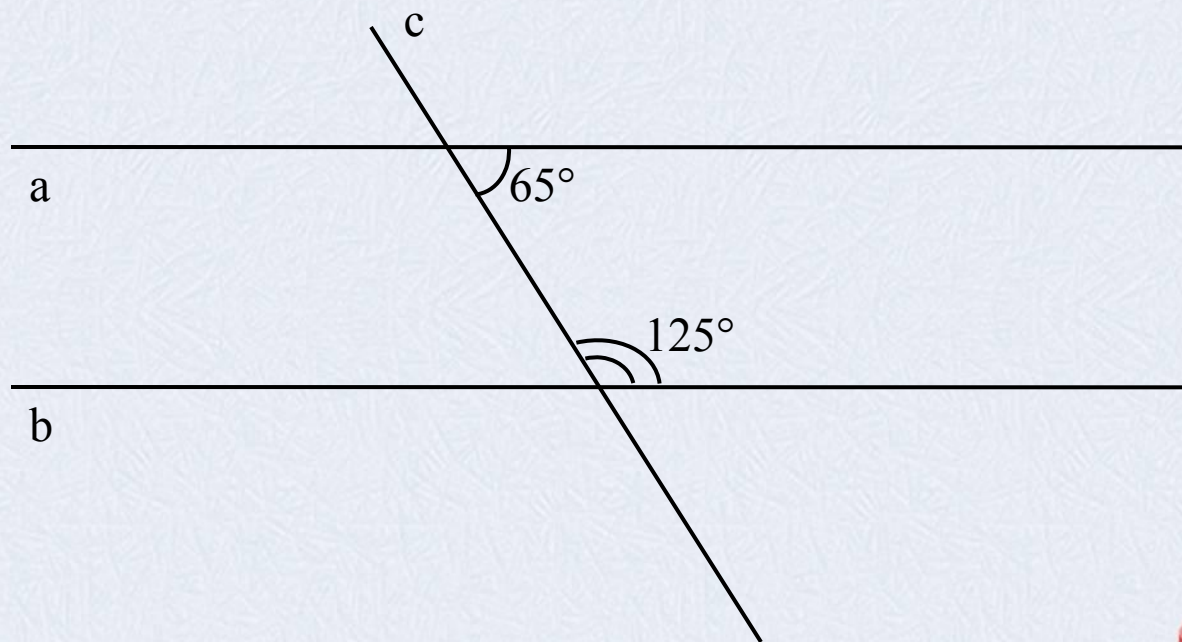

Доказать: $a \parallel b$.

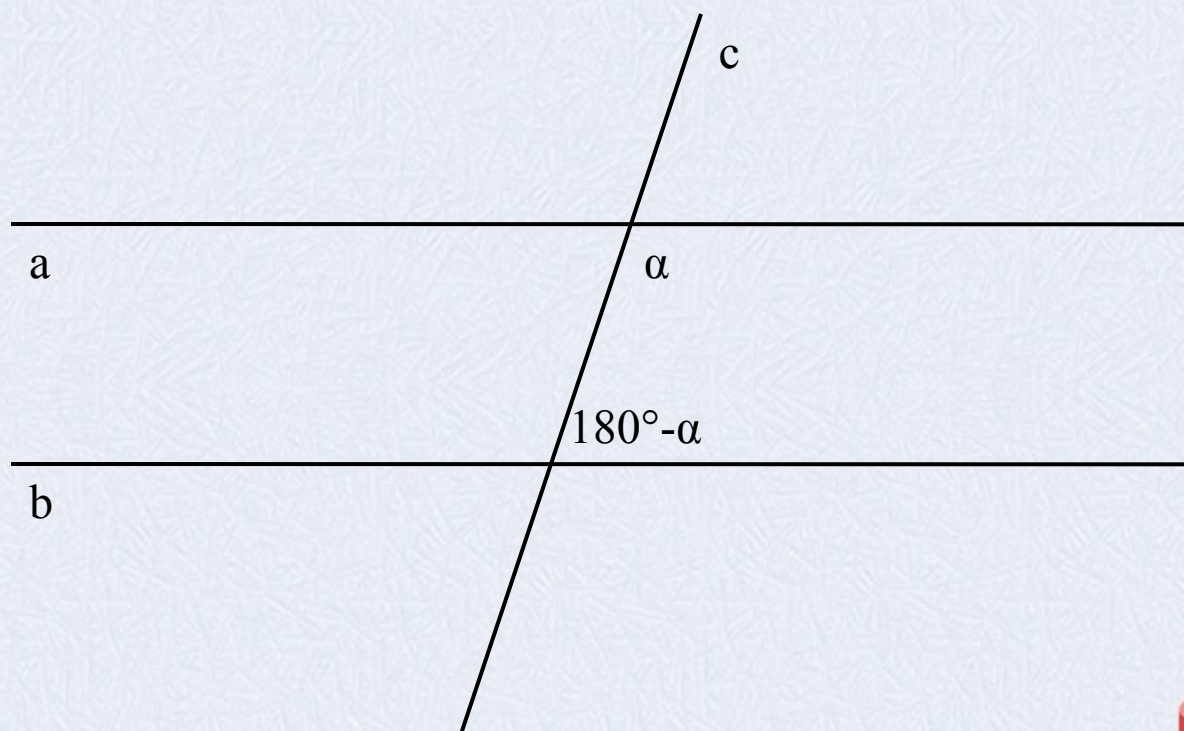

Параллельны ли прямые a и b ?

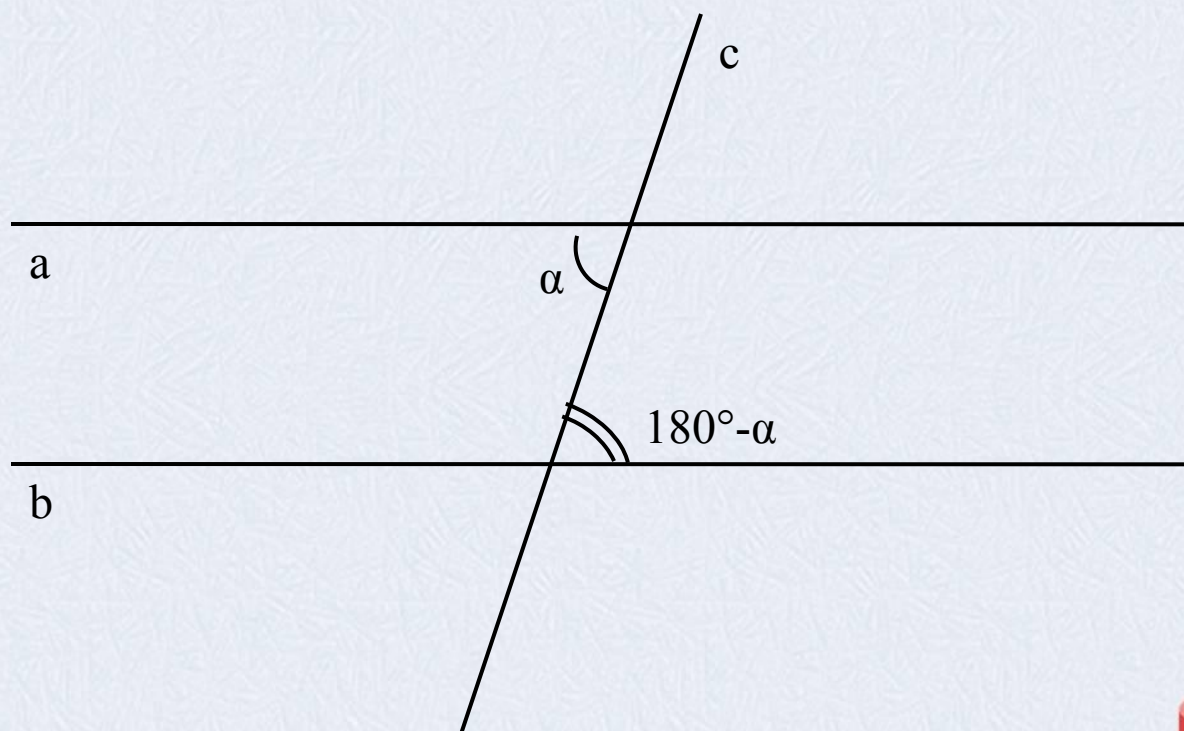

Параллельны ли прямые a и b ?

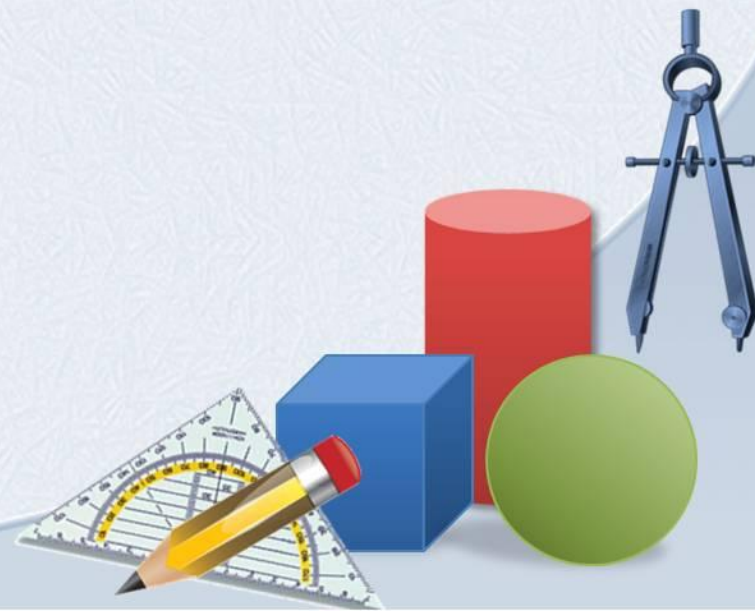
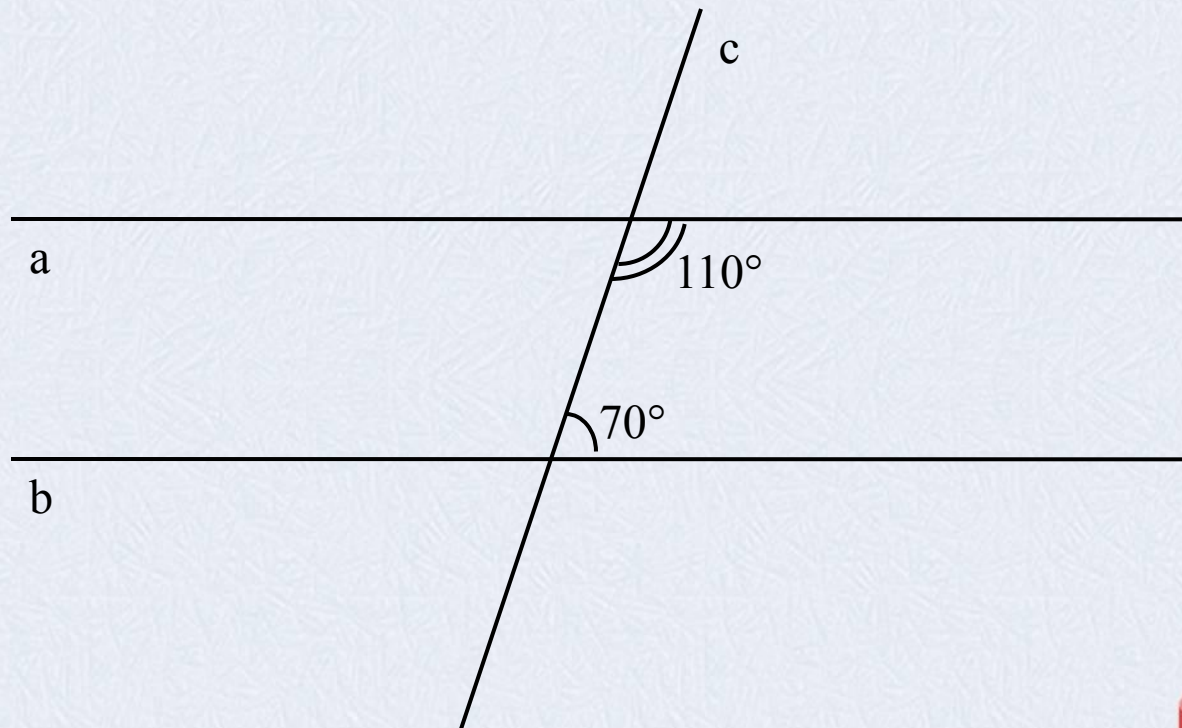

Параллельны ли прямые a и b ?

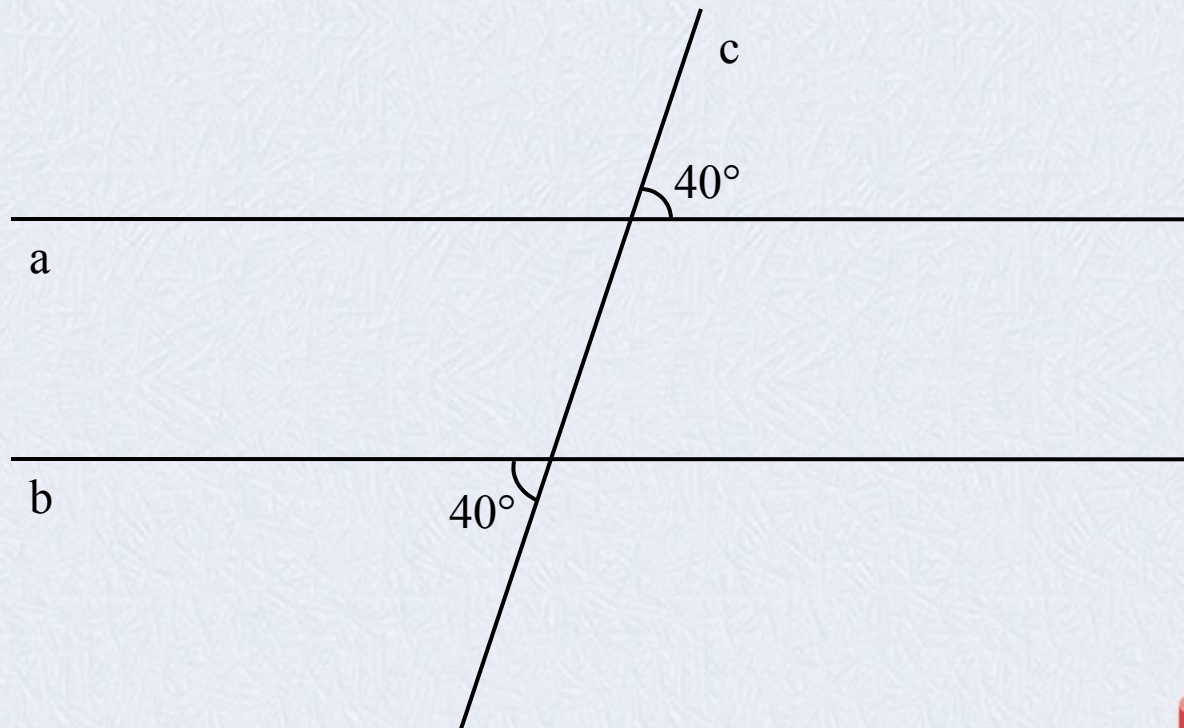

Доказать: $AB \parallel CD$.

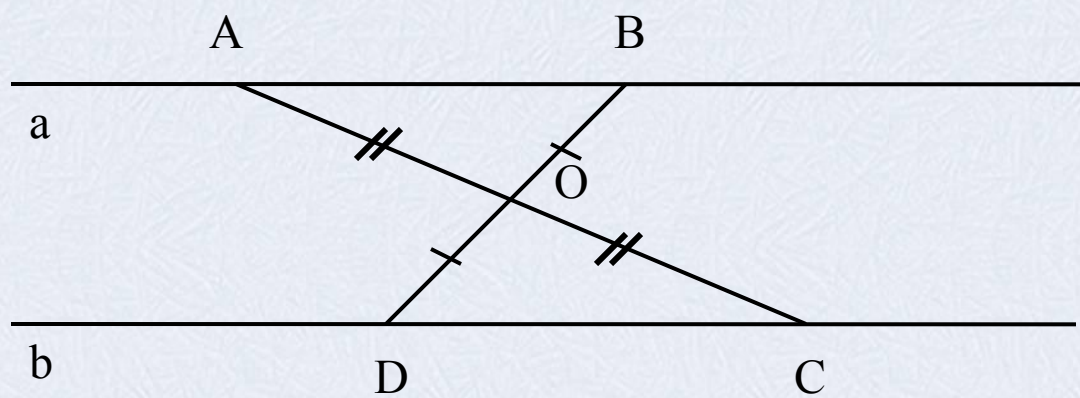

Доказать: $PE \parallel MK$.

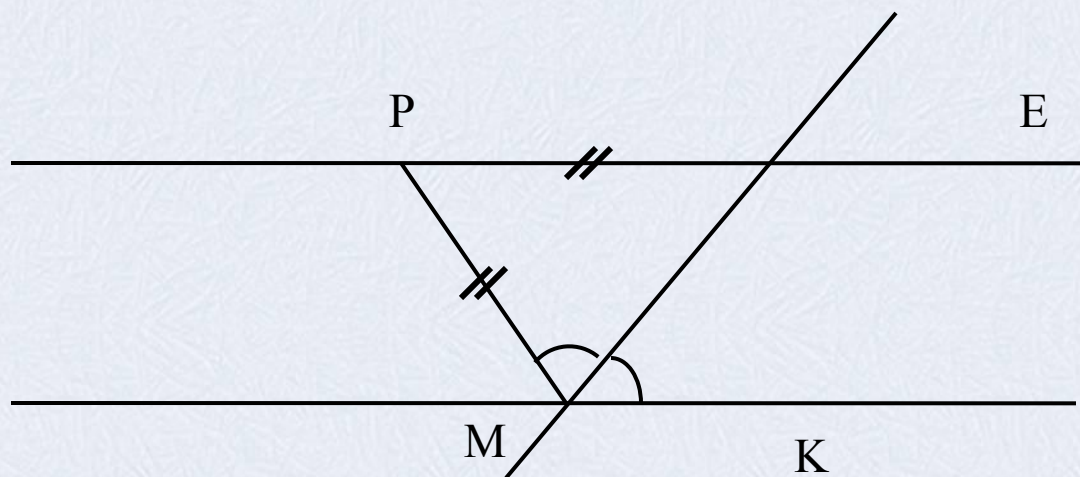

Дано: $AB=BC$

Параллельны ли прямые a и b ?

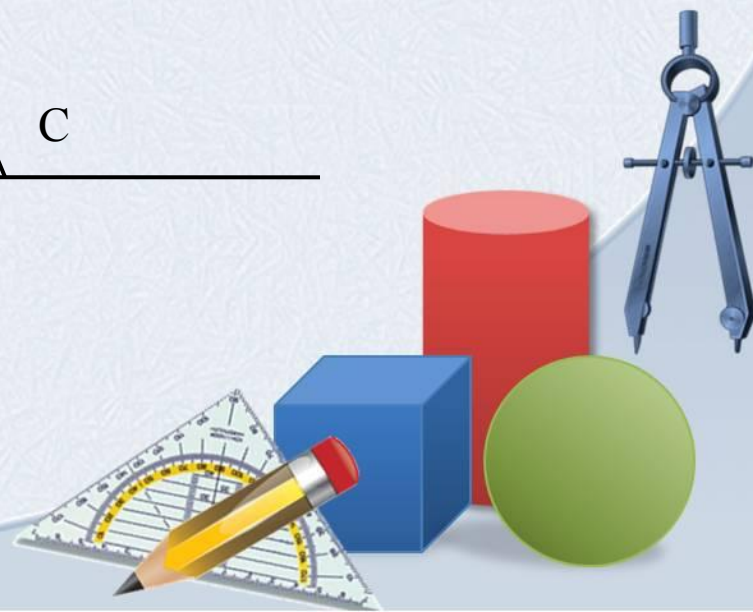
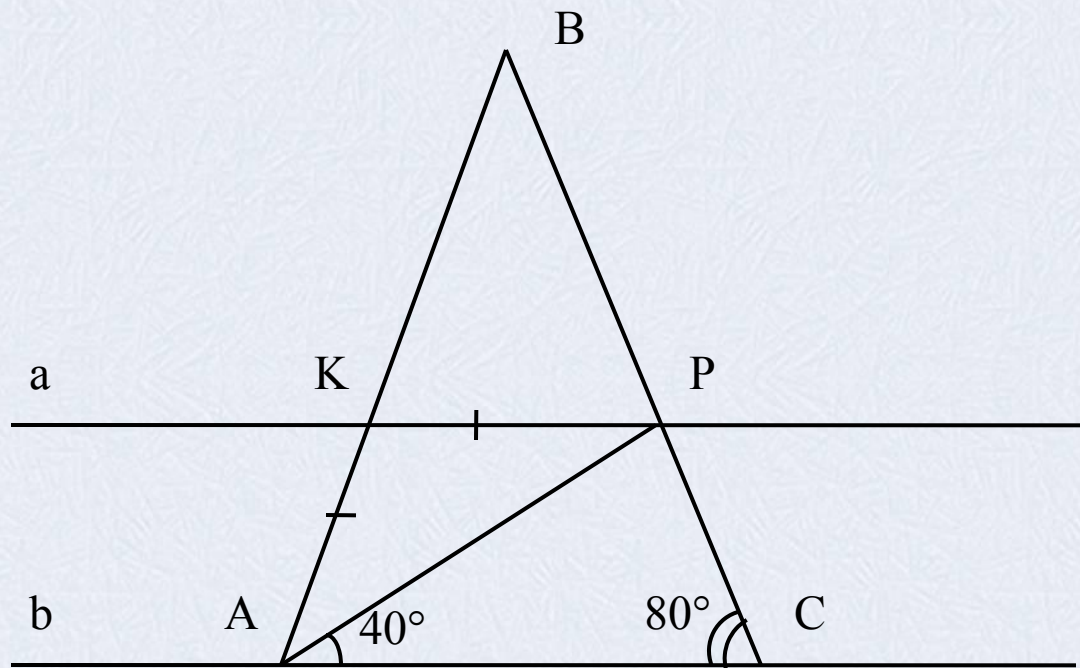

Доказать: $AB \parallel CD$; $AD \parallel BC$.

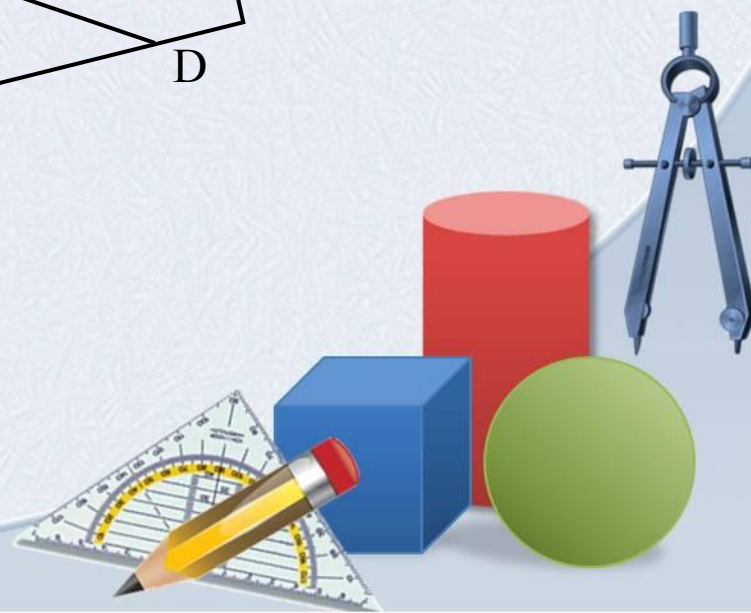
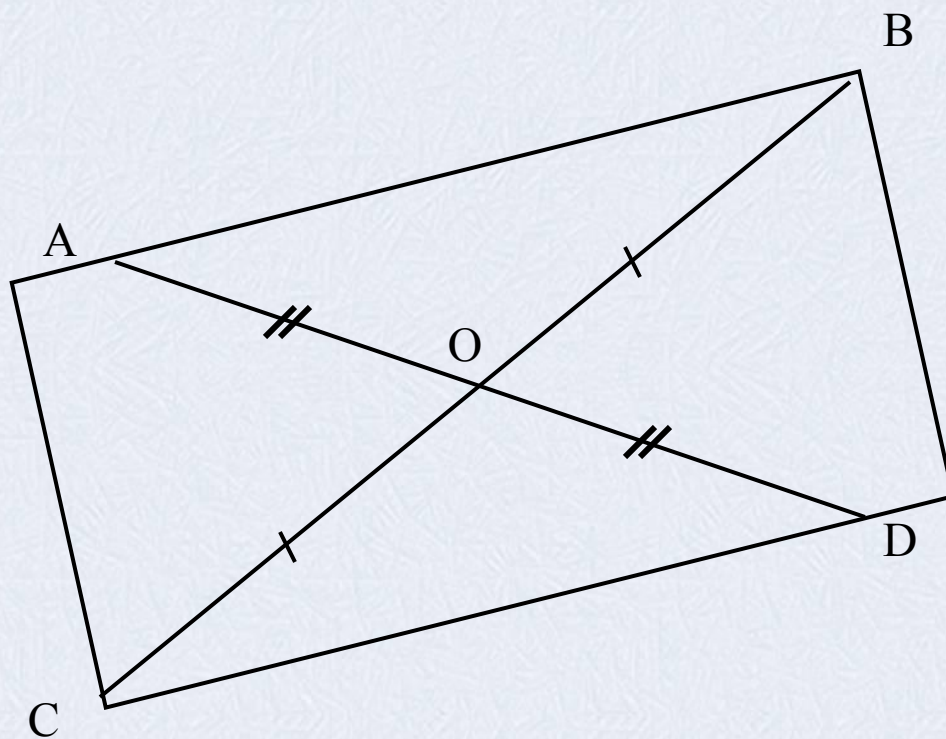

Доказать: $AB \parallel CD$; $AD \parallel BC$.

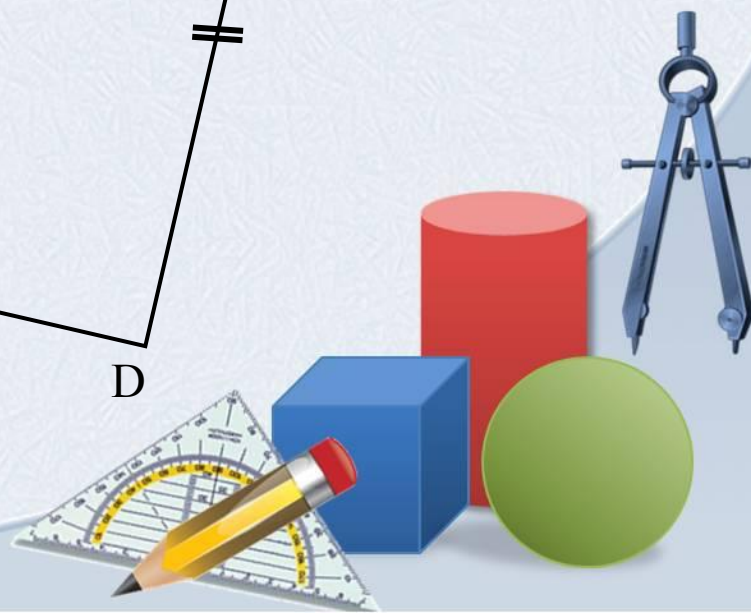
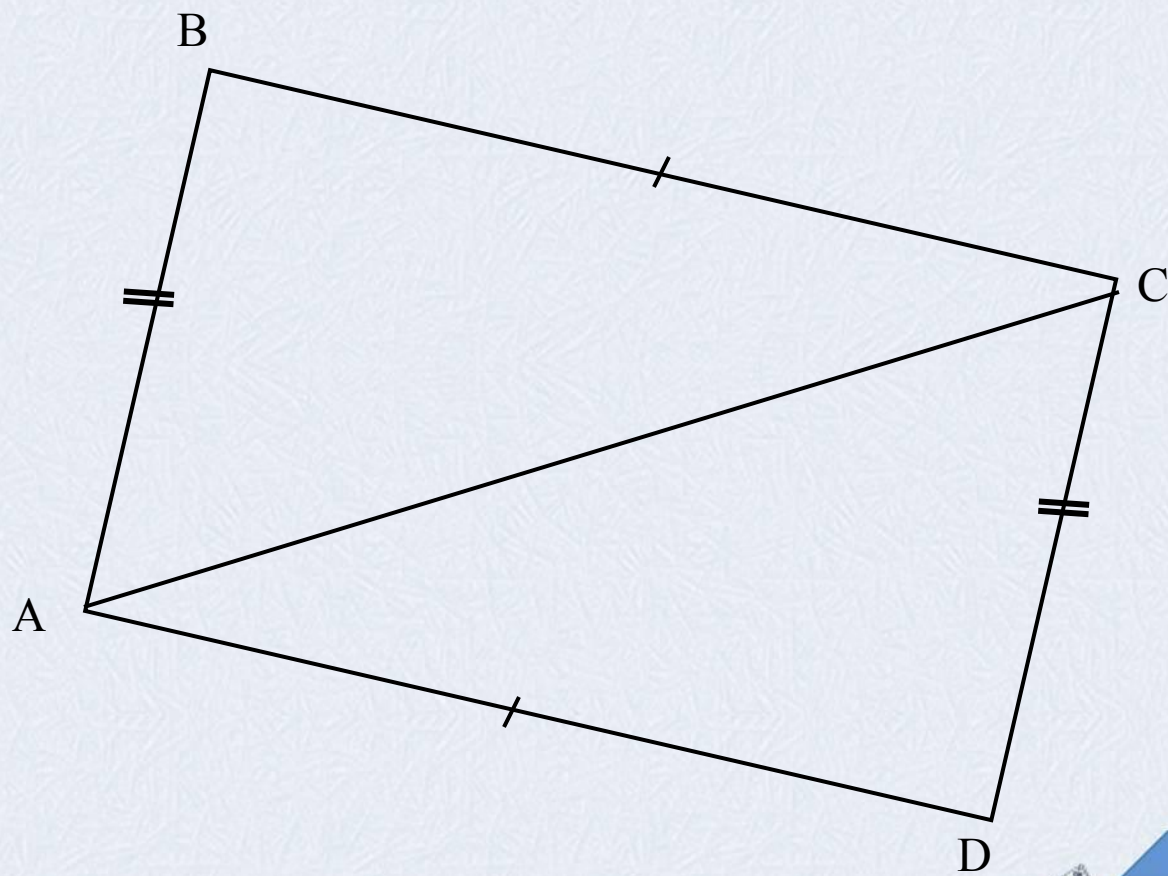

Доказать: $AB \parallel DE$.

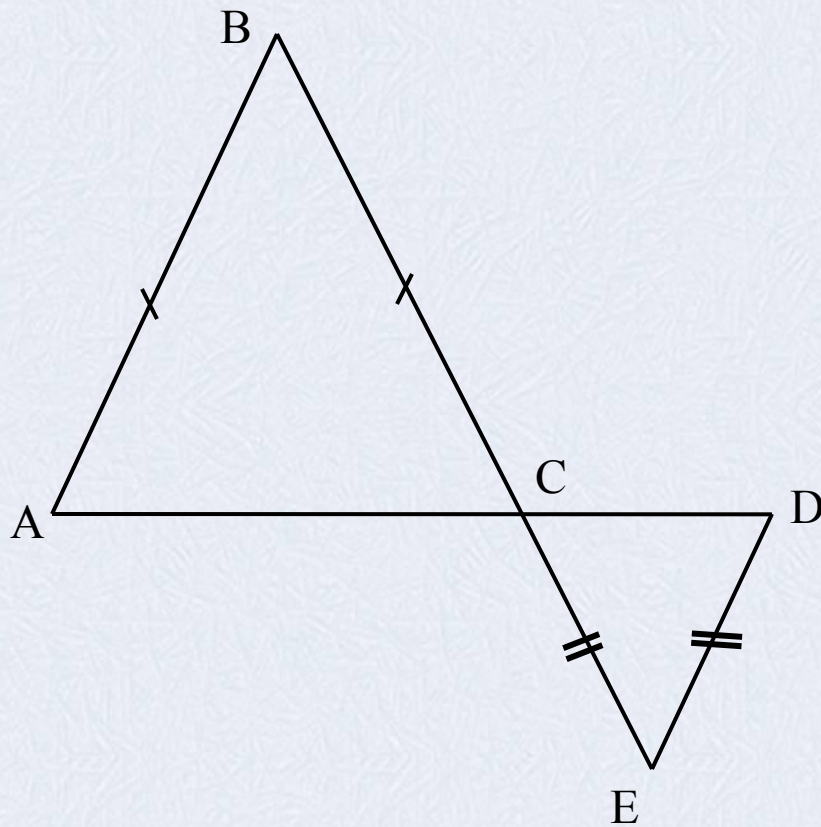

Доказать: $AB \parallel MN$.

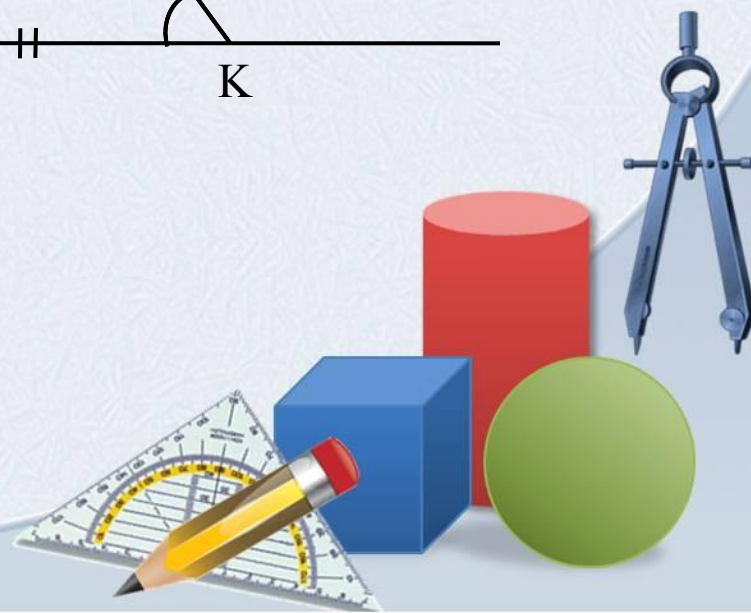
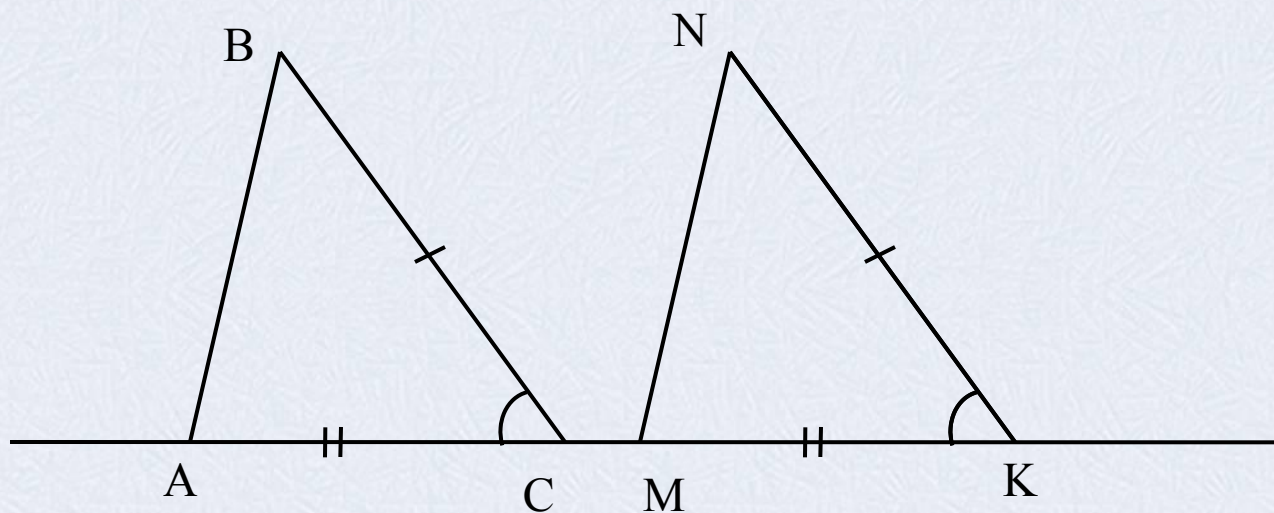

Дано: $\angle 1 = 75^\circ$; $a \parallel b$.
Найти: $\angle 2$, $\angle 3$, $\angle 4$.

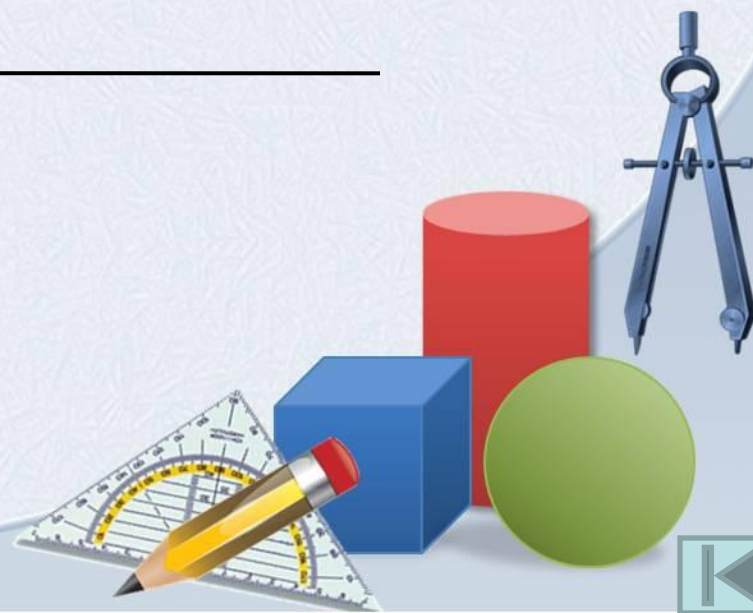
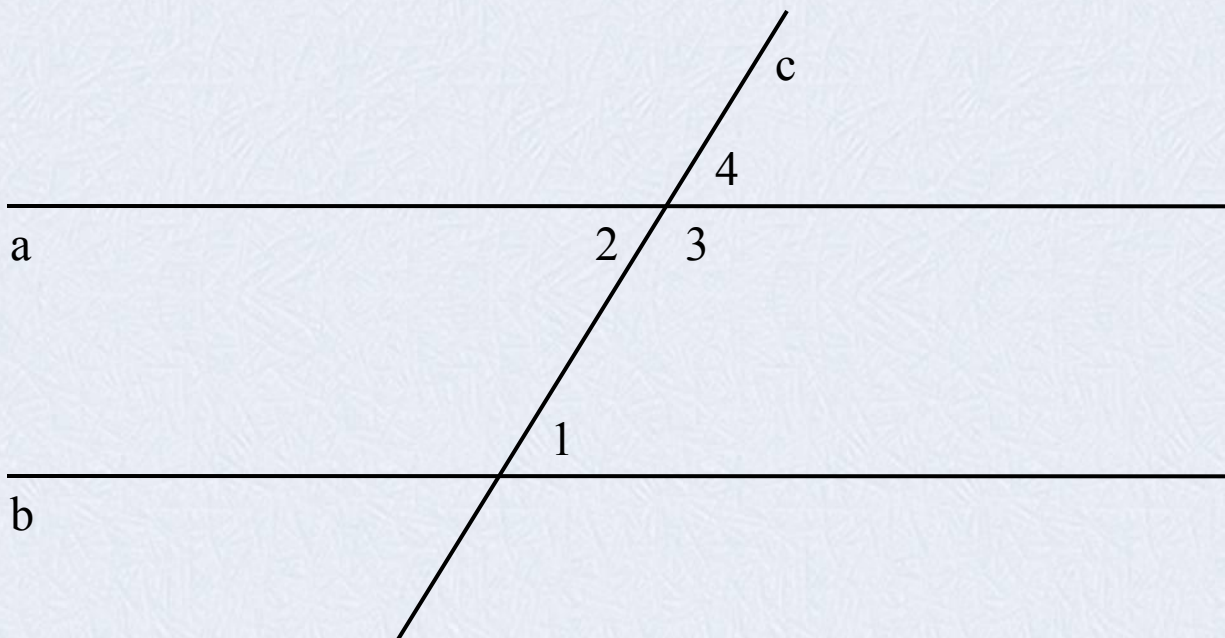

Дано: $\angle 1 + \angle 2 = 160^\circ$; $a \parallel b$.
Найти: $\angle 3$, $\angle 4$, $\angle 5$, $\angle 6$.

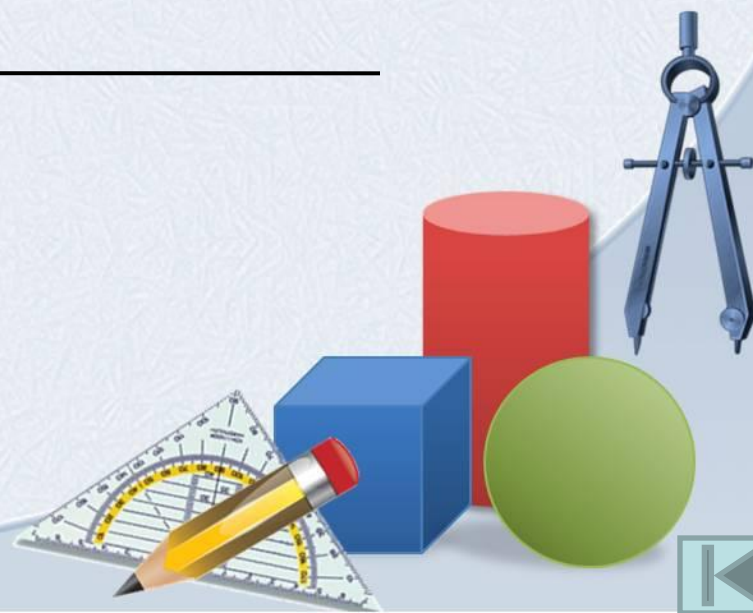
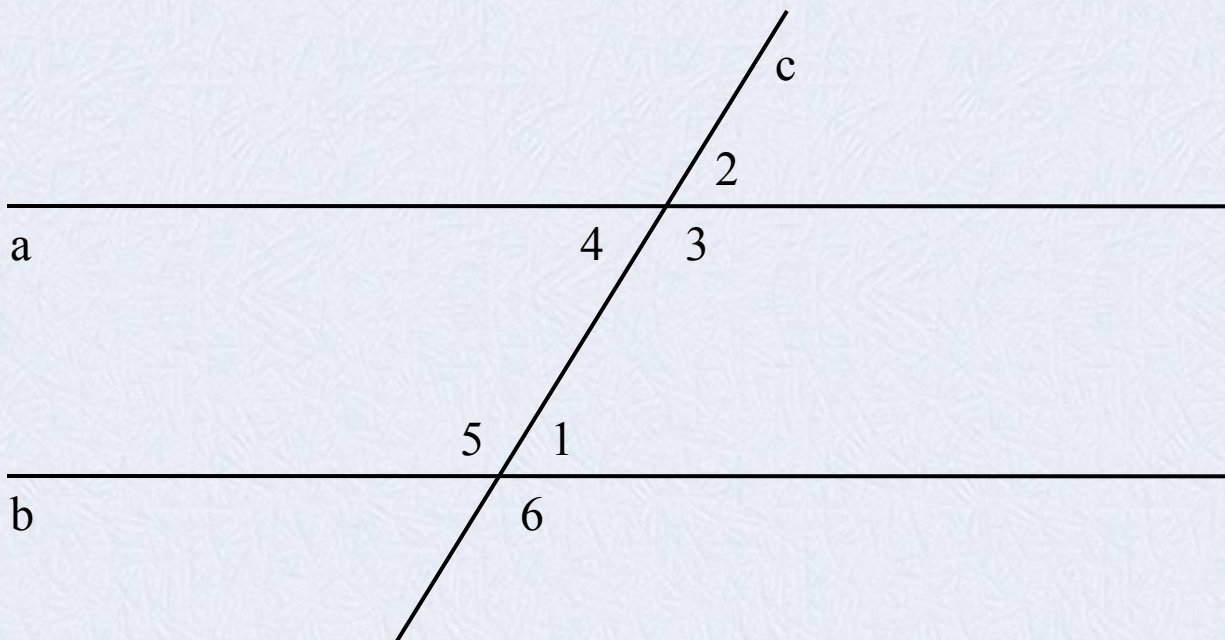

Дано: $a \parallel b$; $\angle 1$ в 4 раза меньше $\angle 2$.
Найти: $\angle 3$.

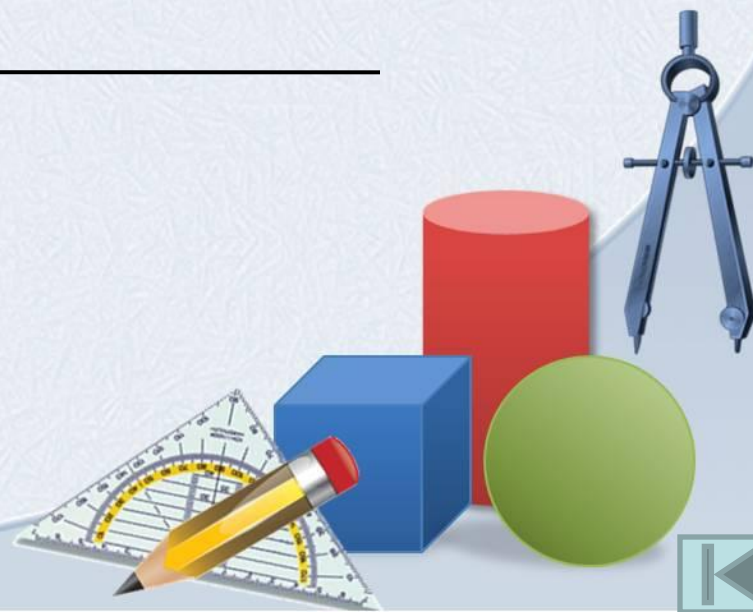
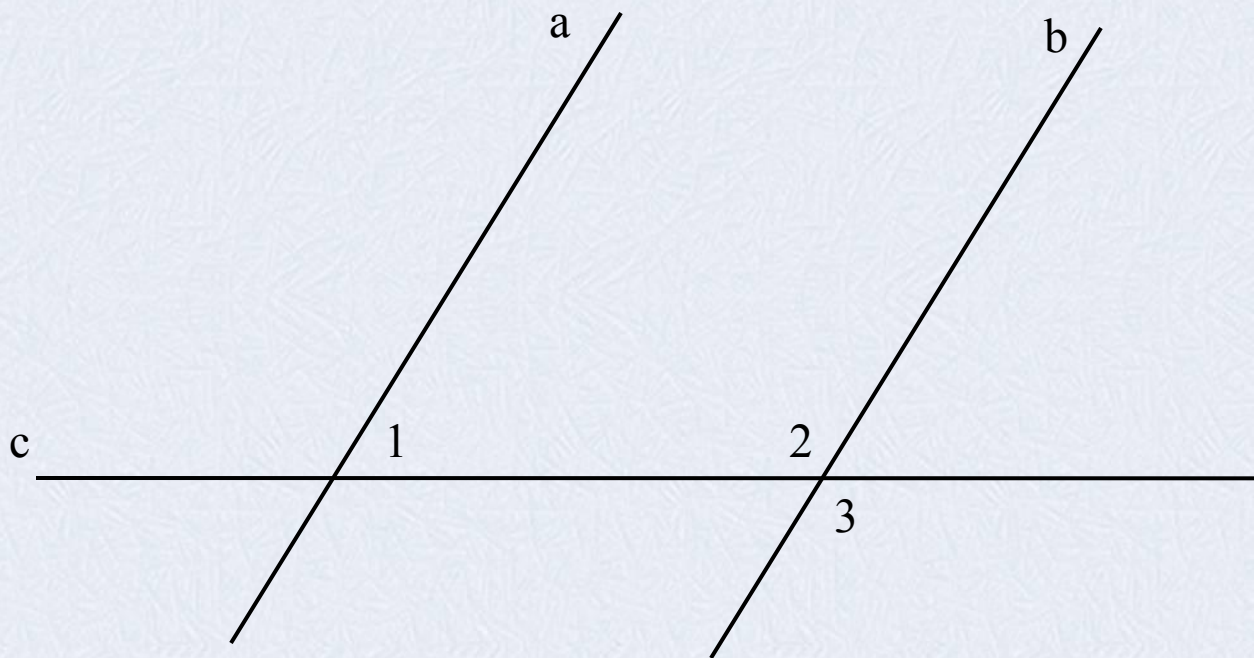

Дано: $x \parallel y$; $\angle 1 + \angle 2 = 100^\circ$.
Найти: $\angle 3$.

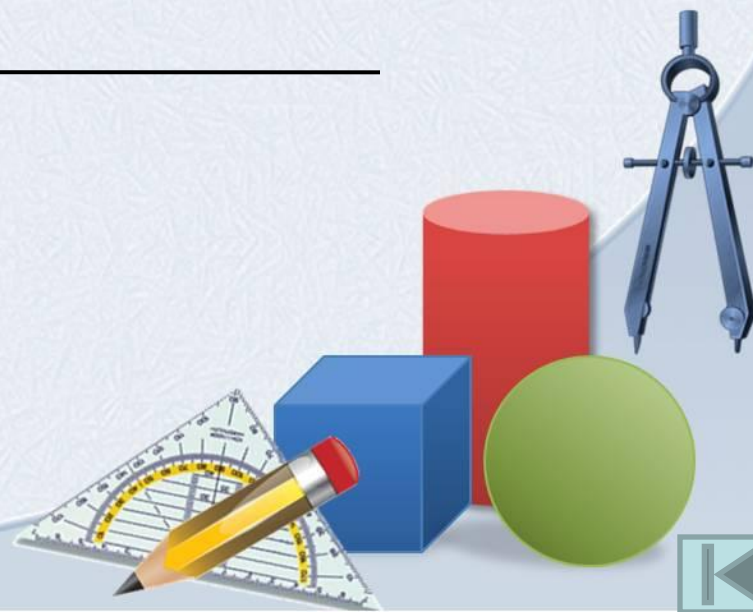
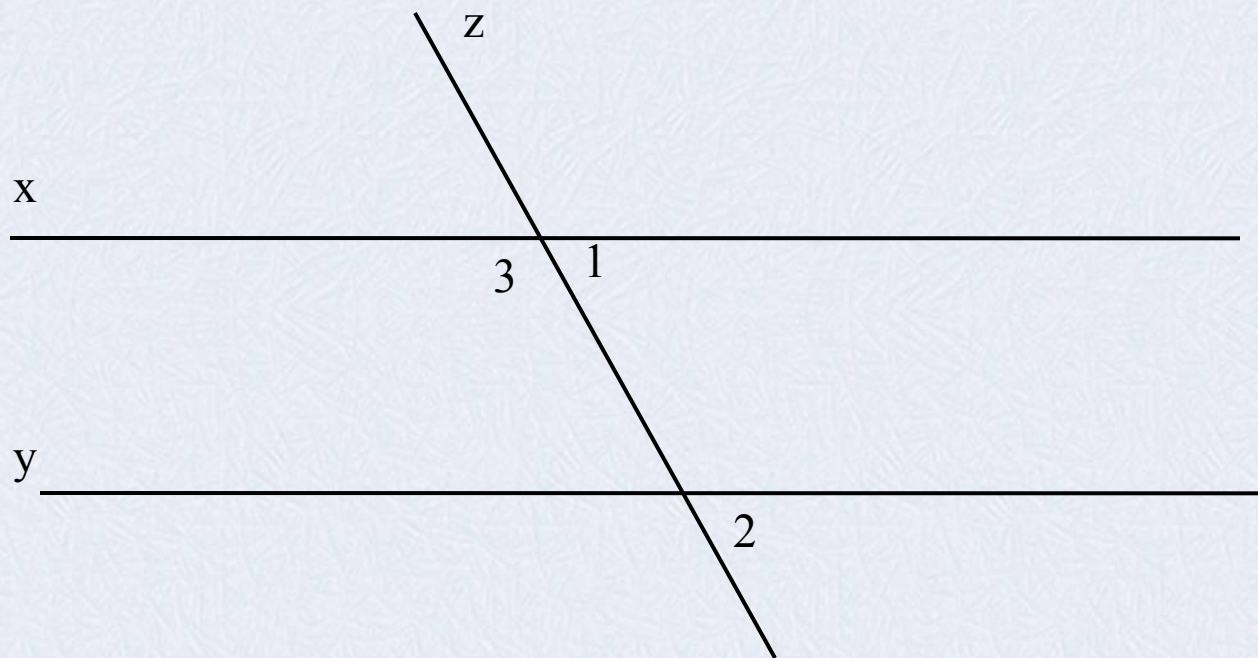

Дано: $q \parallel z$; $\angle 1 : \angle 2 = 2 : 7$.

Найти: $\angle 3$.

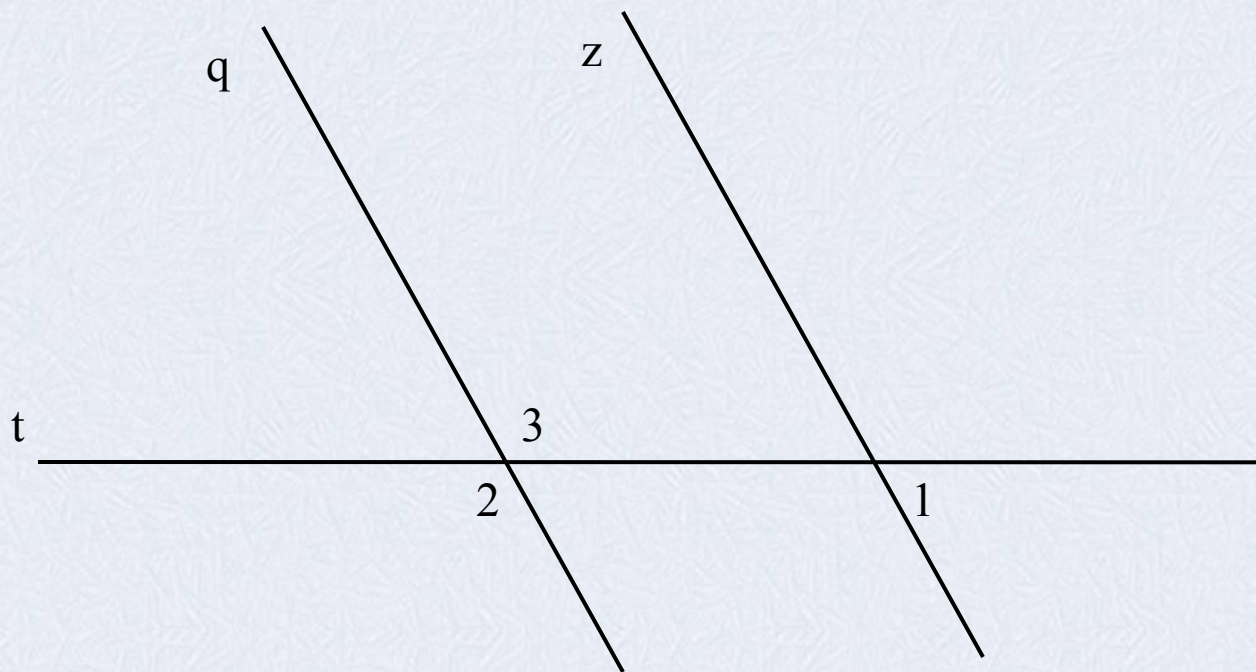

Дано: $m \parallel t$; $\angle 2$ на 90° больше $\angle 1$.
Найти: $\angle 3$.

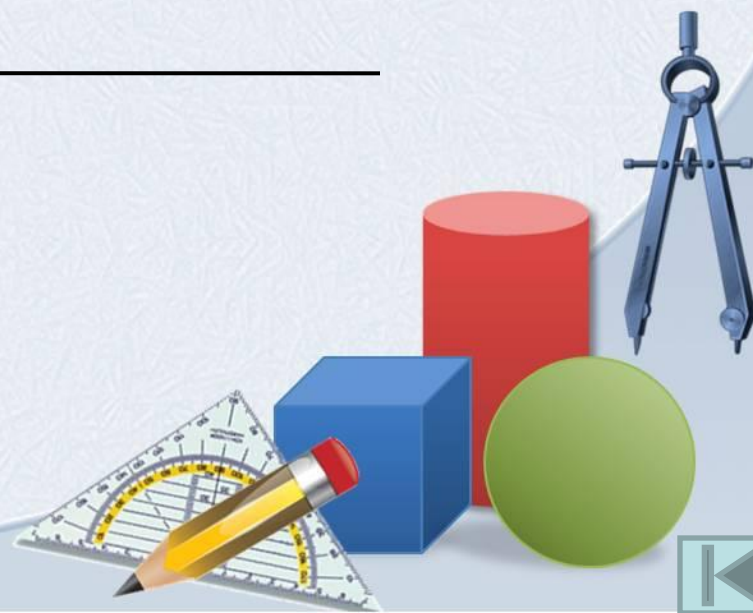
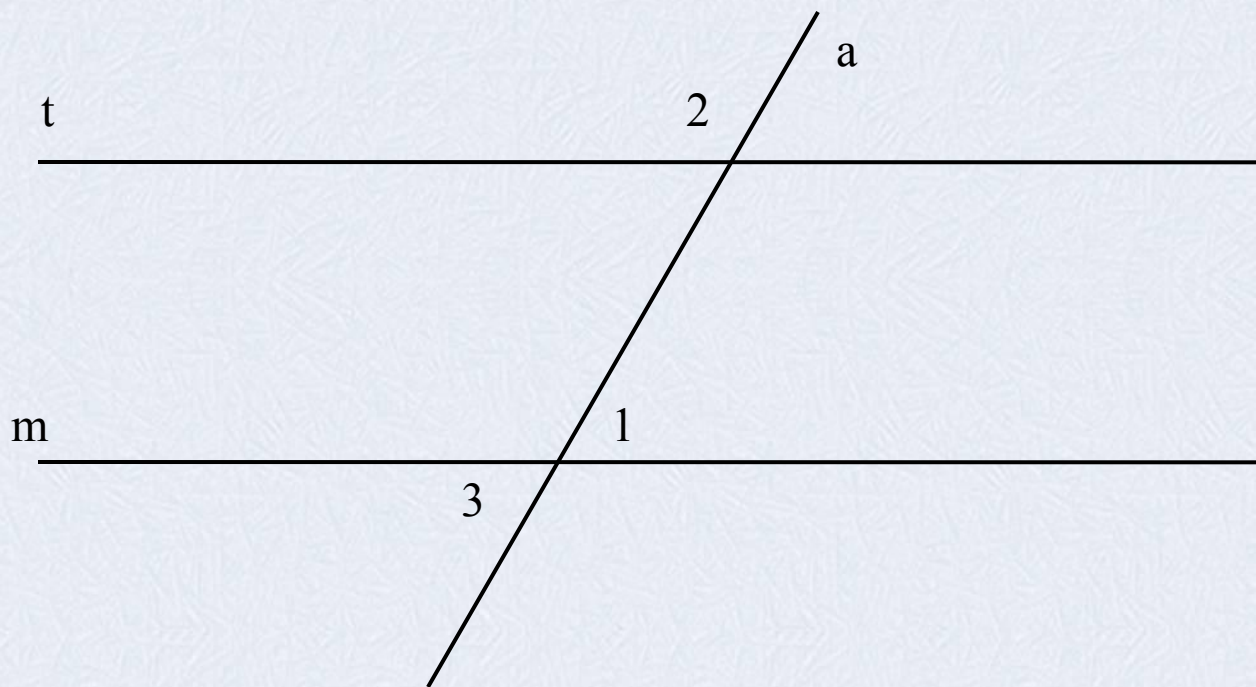

Дано: $a \parallel b$;
Найти: x и y .

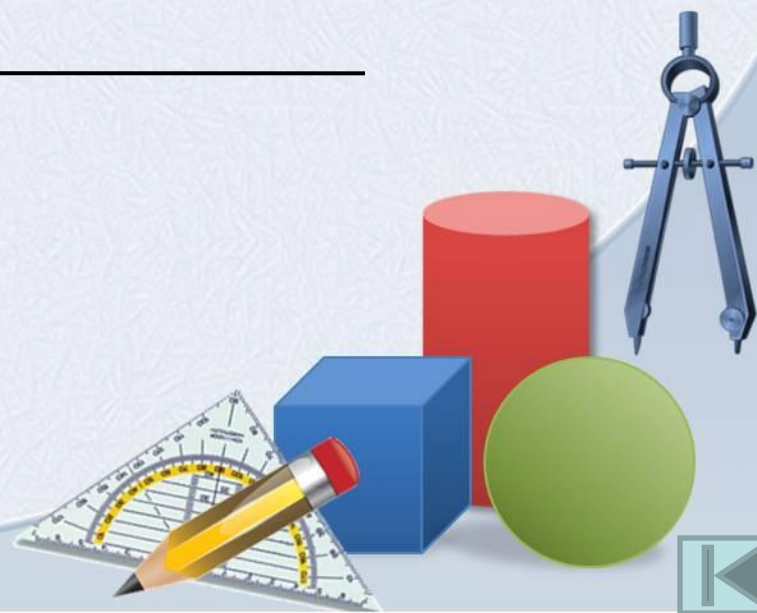
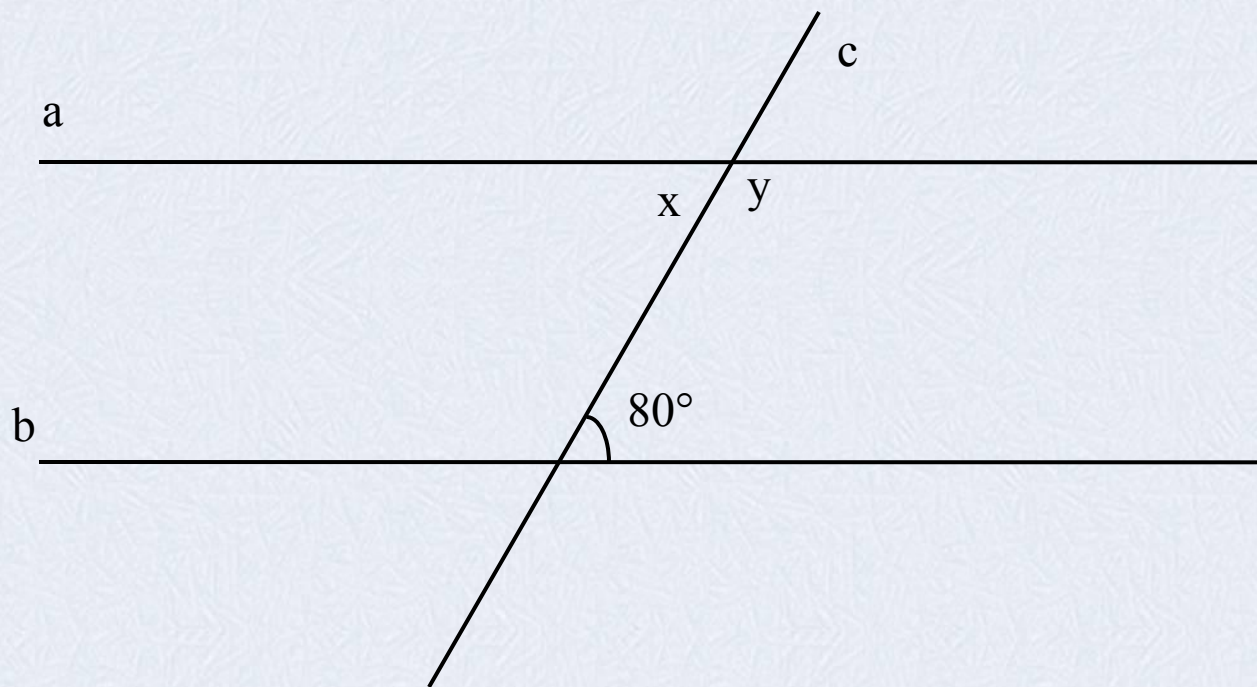

Найти: x .

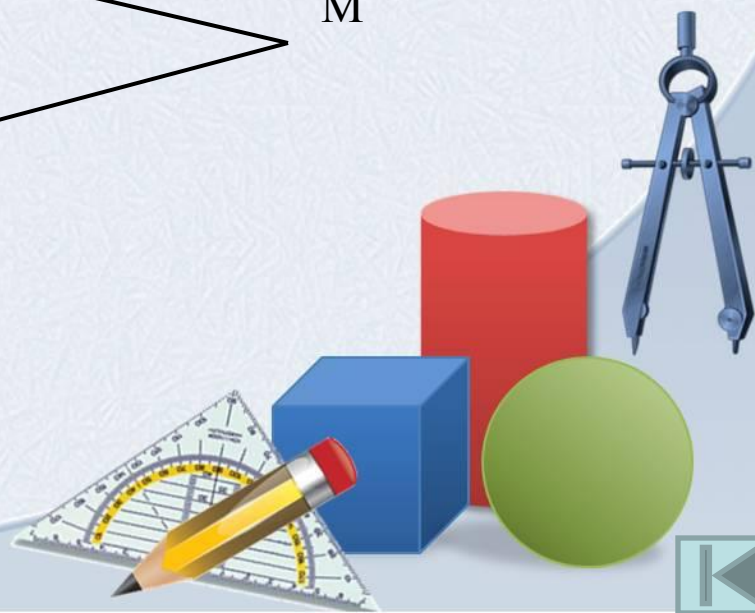
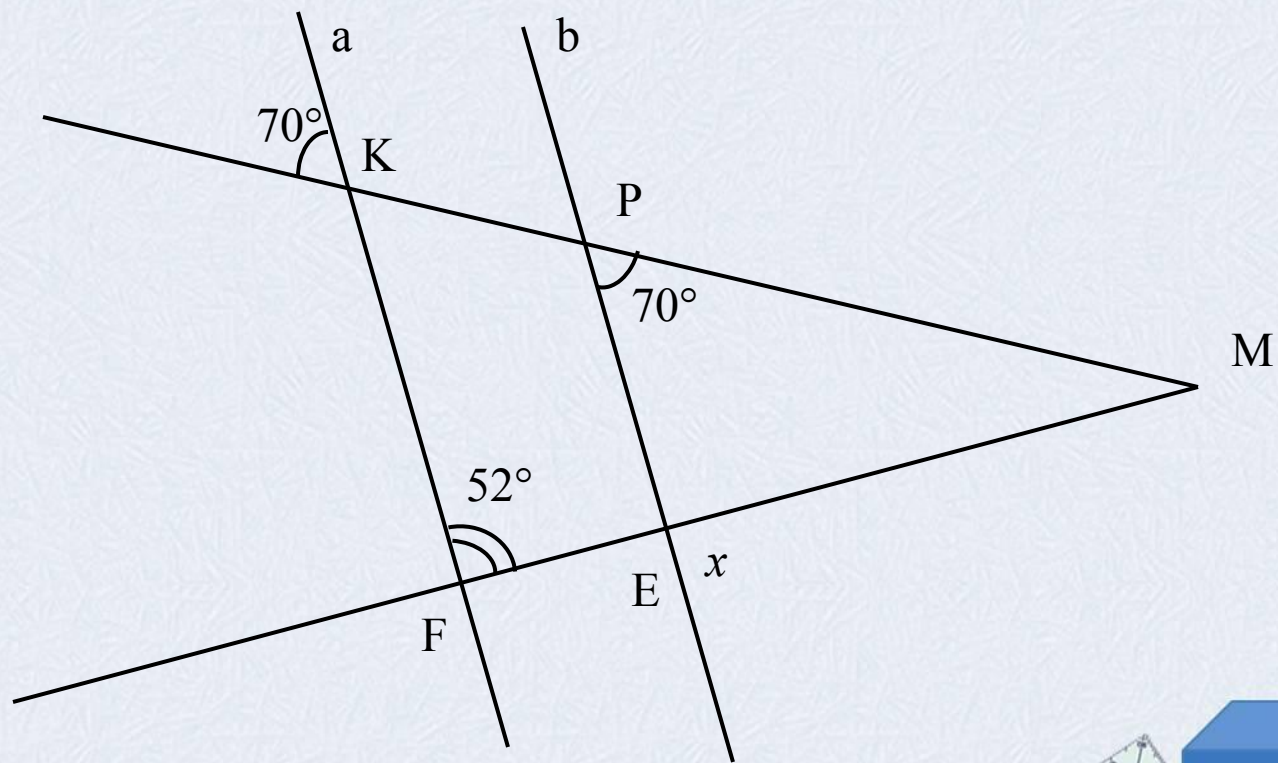

Найти: x и y .

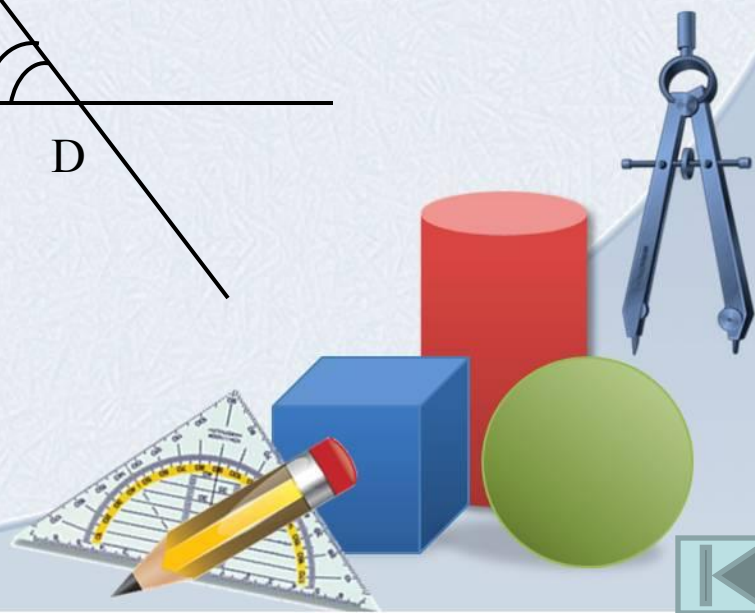
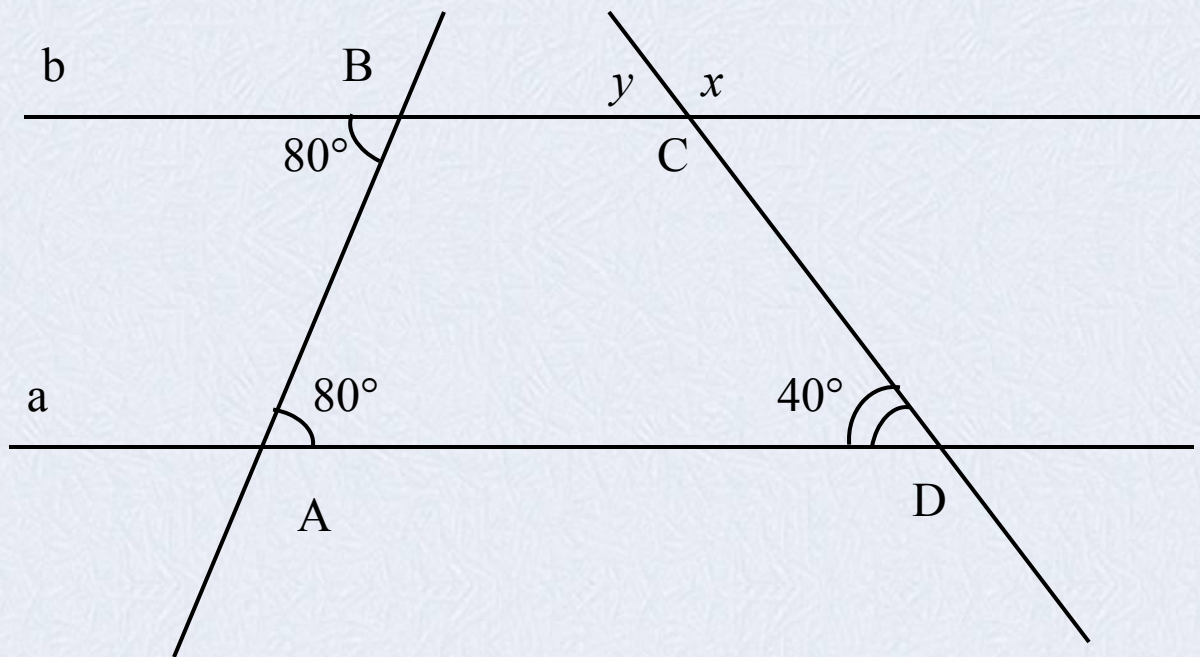

Найти: x .

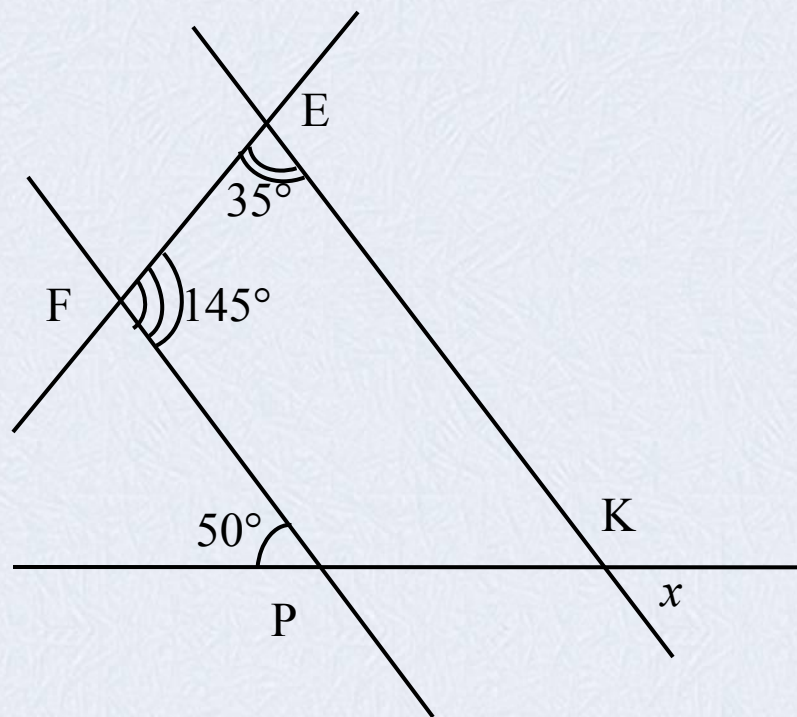

Дано: $\angle ABE = \angle CBE$

Найти: x .

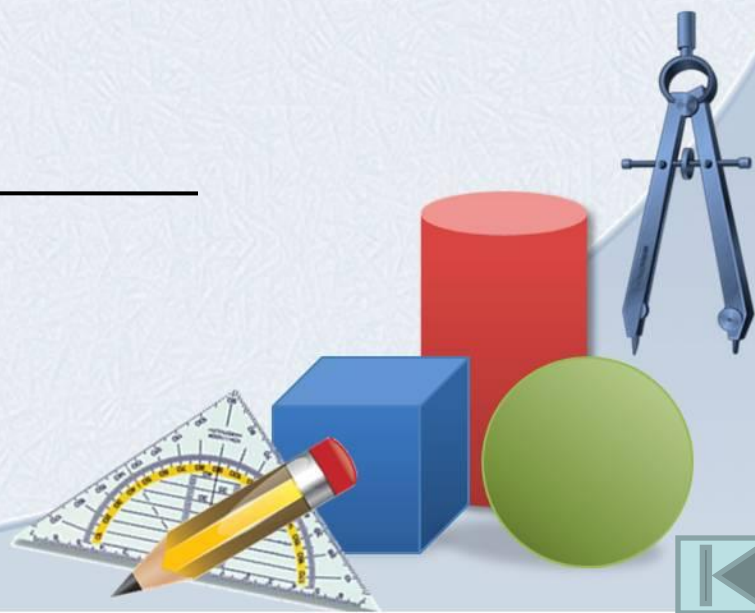
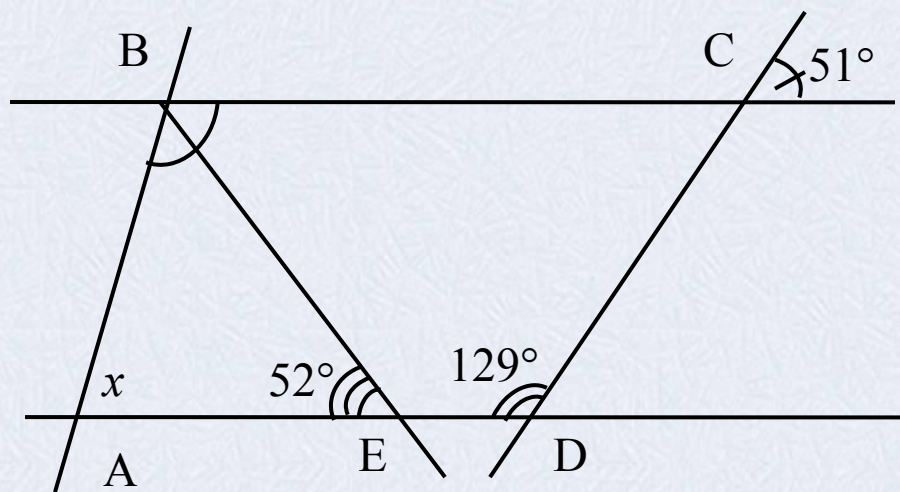

Найти: x .

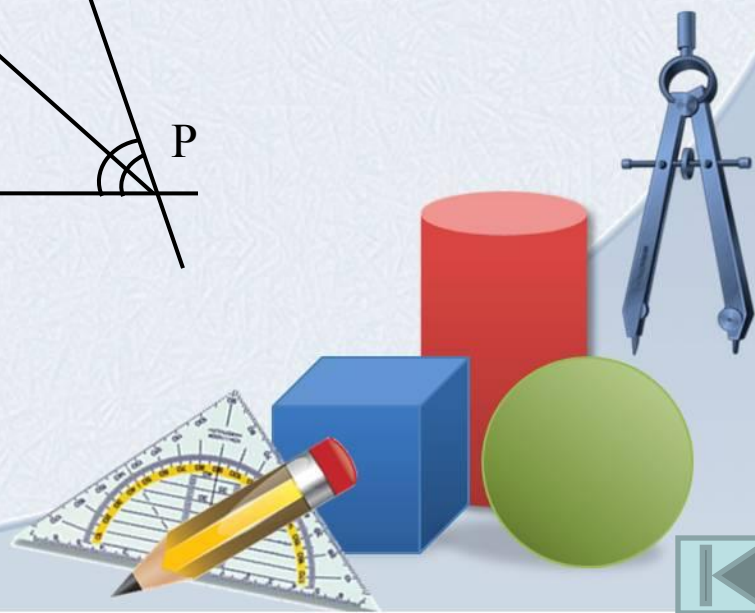
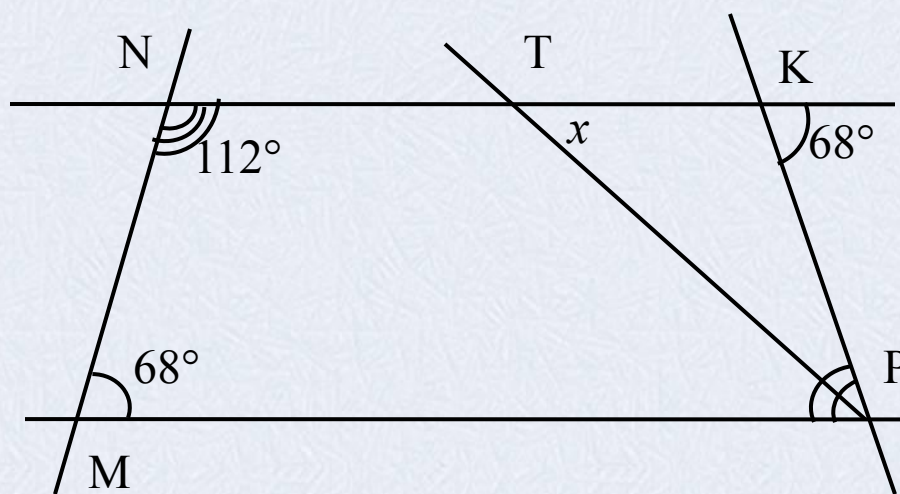

Дано: $AB \parallel DE$.

Доказать: $\angle 1 + \angle 2 = \angle 3$

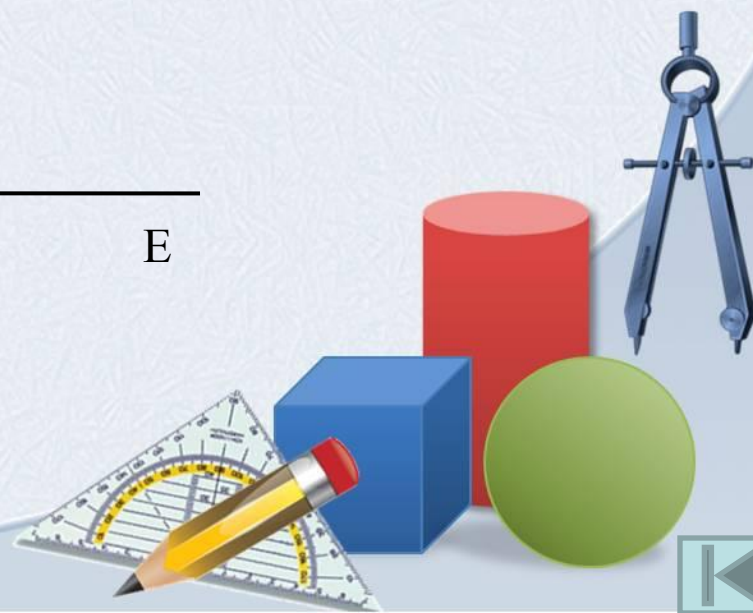
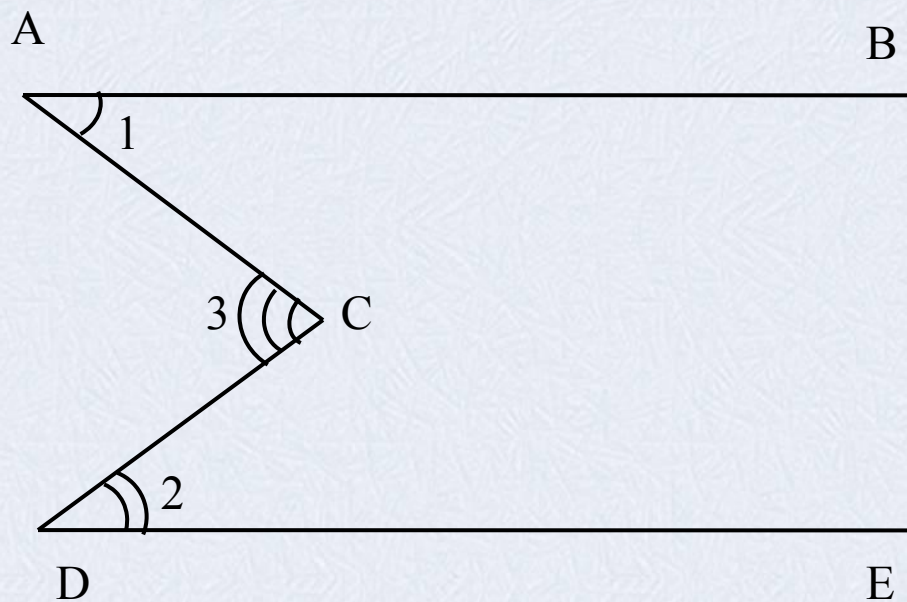

Дано: $a \parallel b$

Доказать: $\angle MOE = 90^\circ$

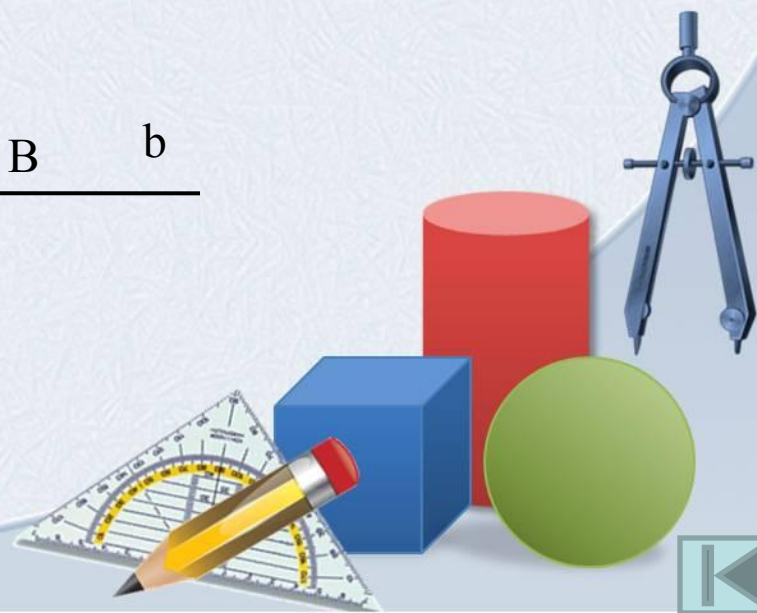
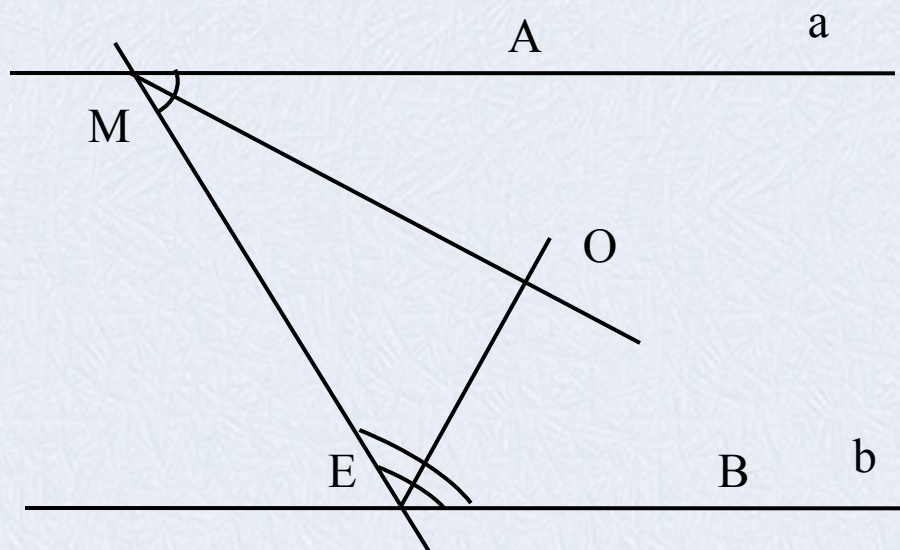

Интернет-ресурсы

Циркуль: <http://www.daviddarling.info/images/compasses.jpg>

Карандаш:

<http://www.proshkolu.ru/content/media/pic/std/3000000/2240000/2239093-7acd9447b354cc7e.gif>

Угольник-транспортир:

http://p.alejka.pl/i2/p_new/25/38/duza-ekierka-geometryczna-z-uchwytem-rottring-14-cm_0_b.jpg

Фон «тетрадная клетка»:

<http://radikal.ua/data/upload/49112/4efc3/3bd0a3d6bb.jpg>

Список литературы

Рабинович Е.М. Задачи и упражнения на готовых чертежах. 7-9 классы. Геометрия. – М.: Илекса, Харьков: Гимназия, 2003. – 56 с.

Гаврилова Н.Ф. Поурочные разработки по геометрии: 7 класс. – М.: ВАКО, 2007.- 304 с.

Шаблон презентации

Ранько Елена Алексеевна
учитель начальных классов

МАОУ лицей №21

г. Иваново

Сайт: <http://pedsovet.su/>

