

Basic Principles of Ultrasonic Testing

Basic Principles of Ultrasonic Testing

Theory and Practice

Basic Principles of Ultrasonic Testing

Examples of oscillation

ball on a spring

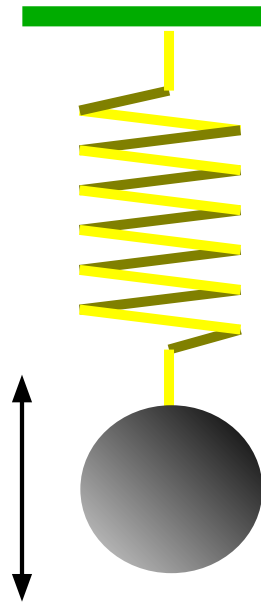

pendulum

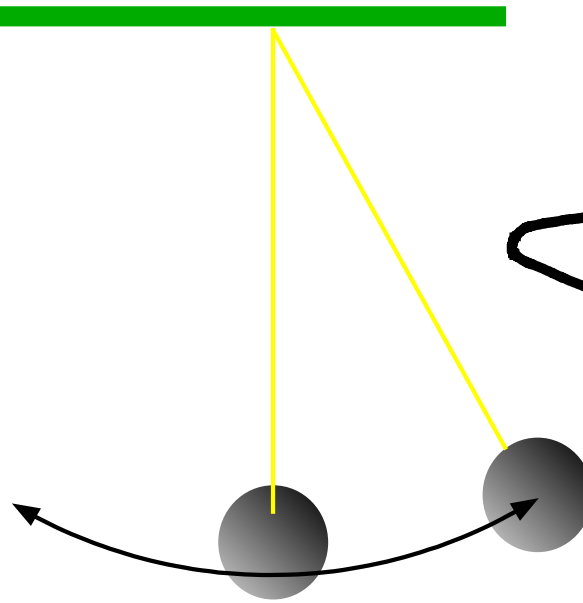

rotating earth

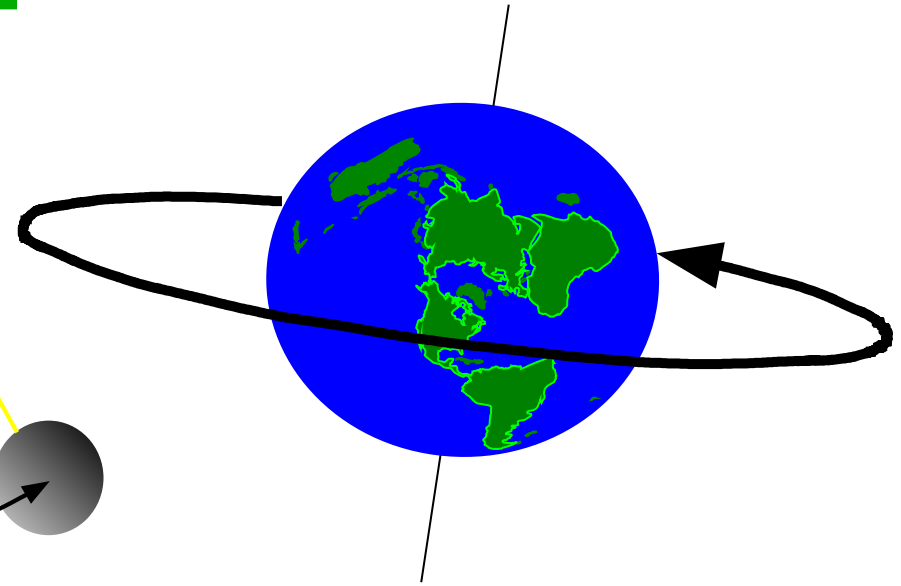

Basic Principles of Ultrasonic Testing

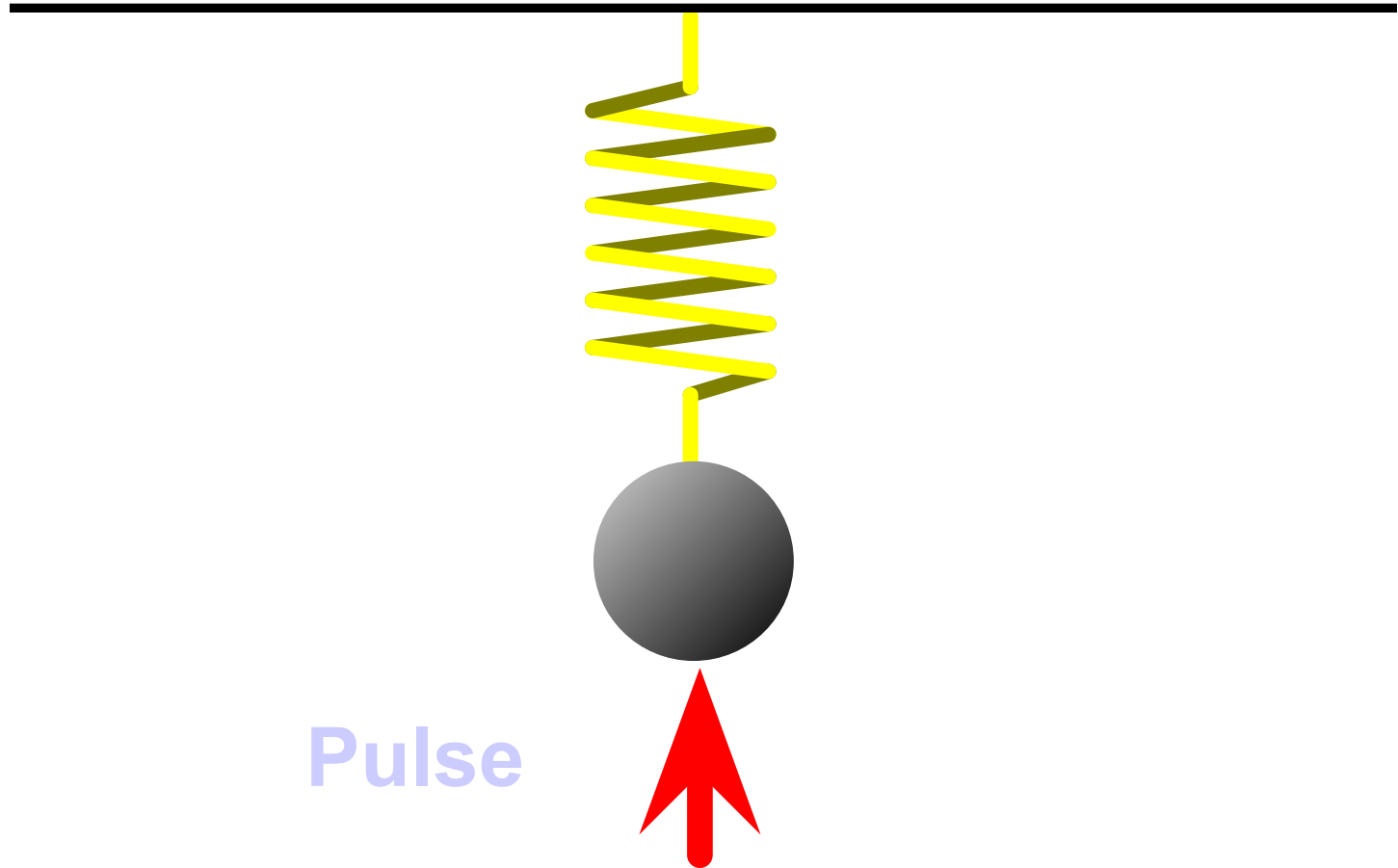

The ball starts to oscillate as soon as it is pushed

Basic Principles of Ultrasonic Testing

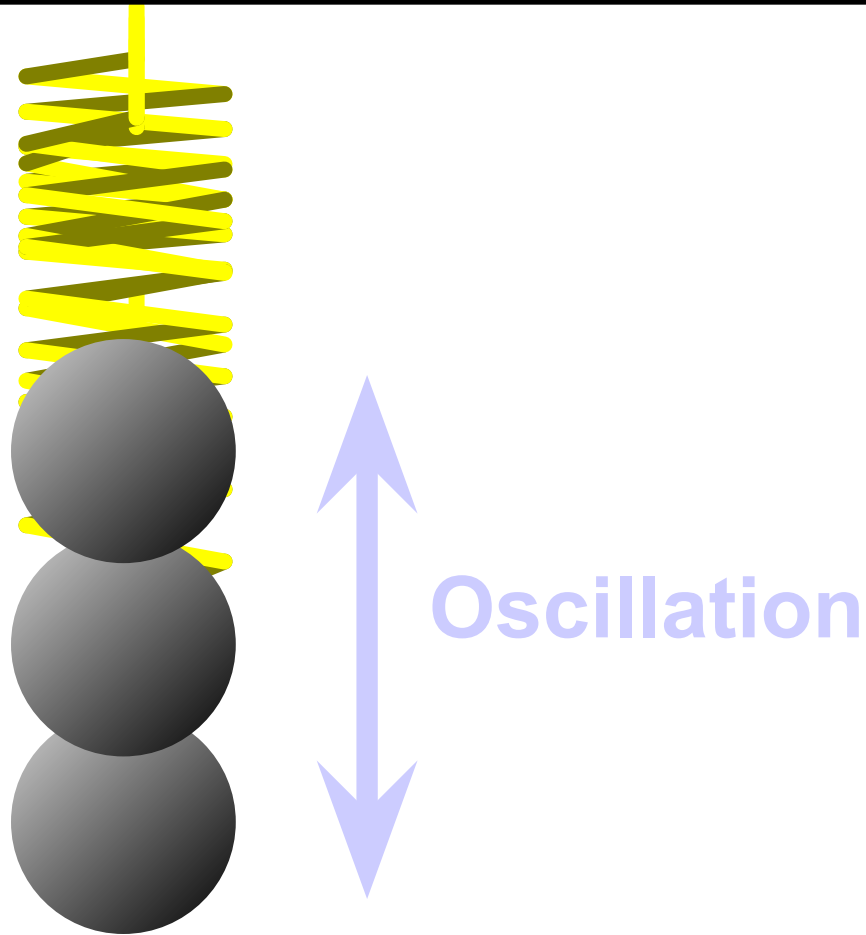

Basic Principles of Ultrasonic Testing

Movement of the ball over time

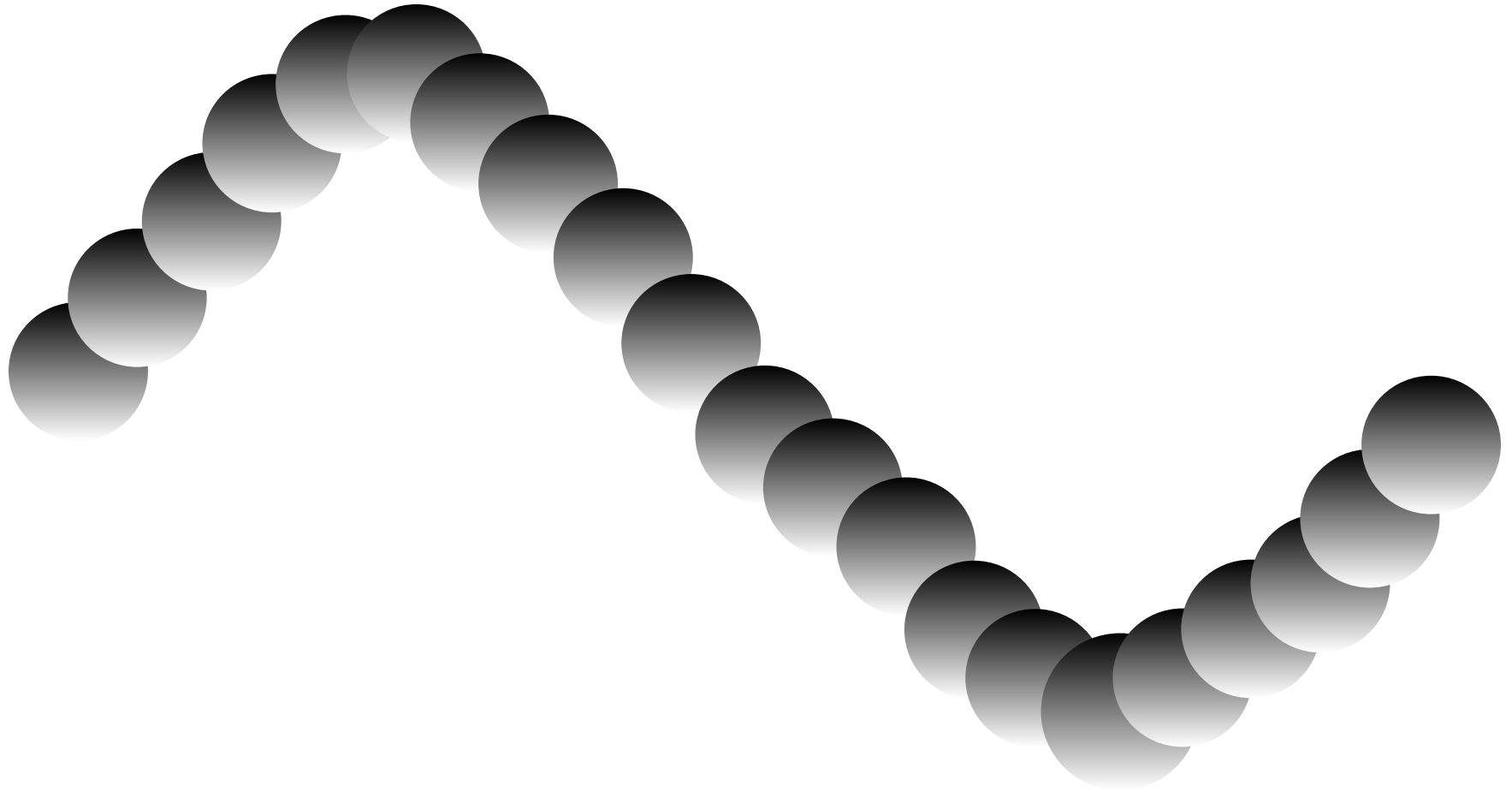

Basic Principles of Ultrasonic Testing

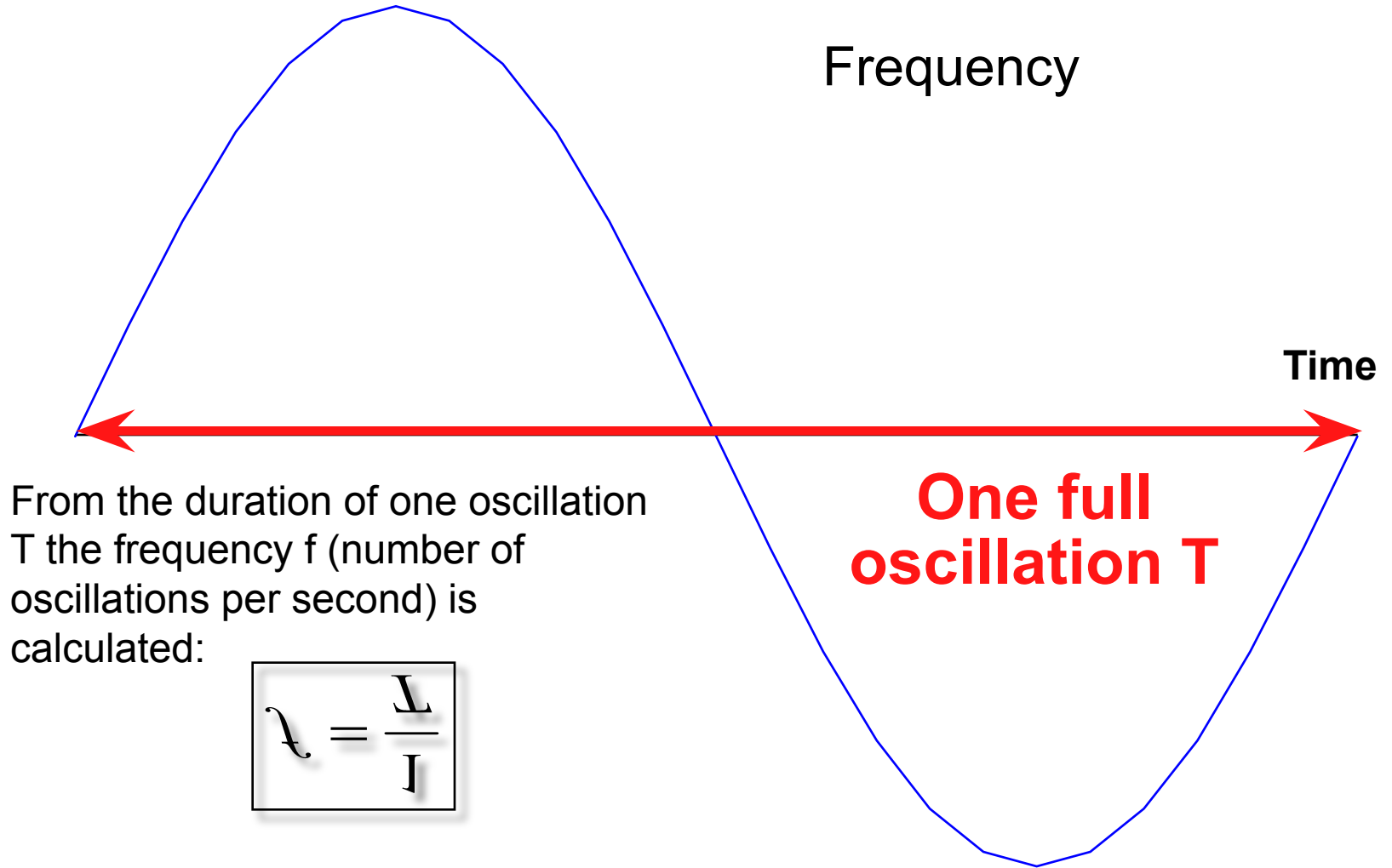

$$f = \frac{1}{T}$$

Basic Principles of Ultrasonic Testing

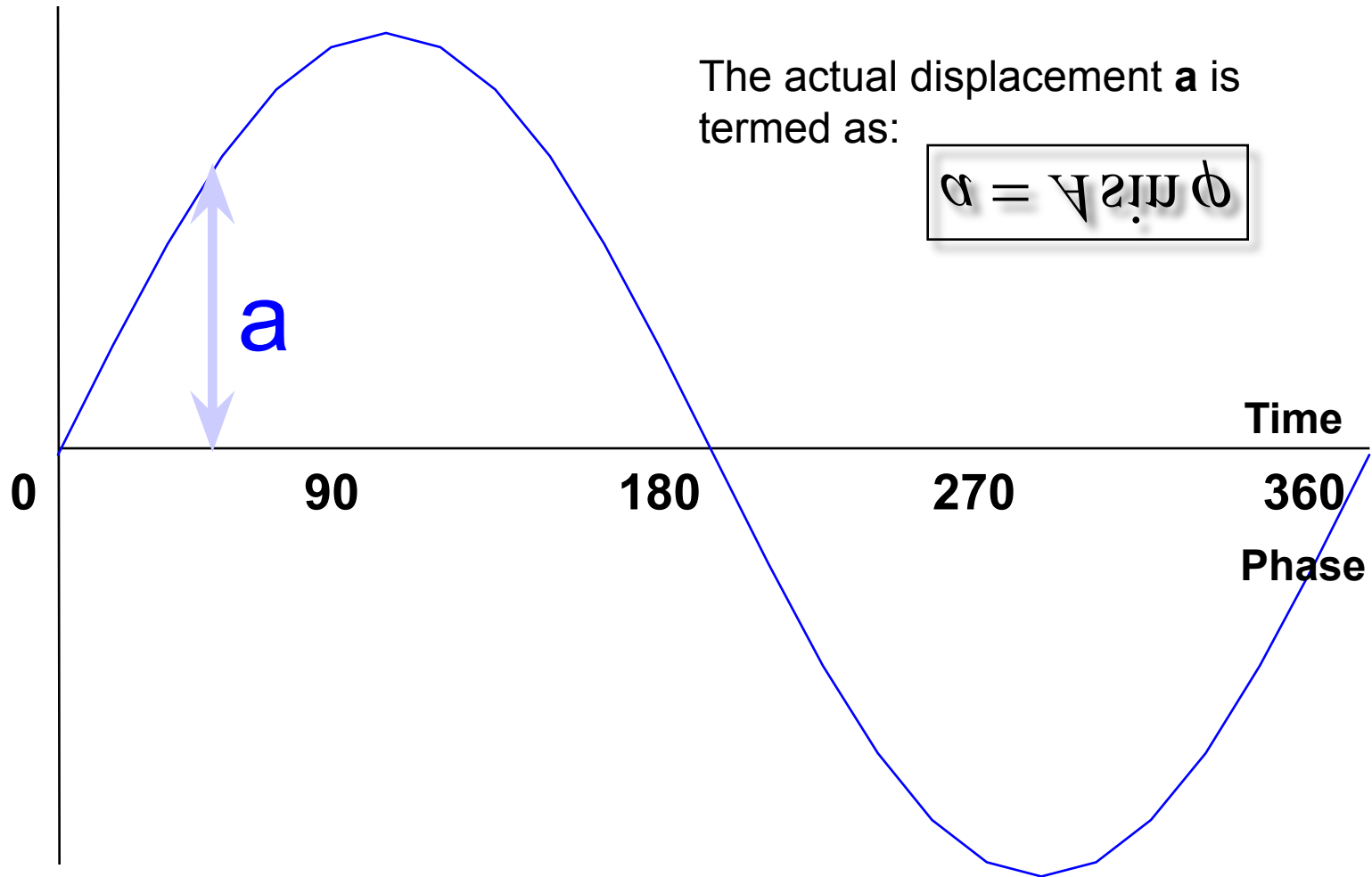

Basic Principles of Ultrasonic Testing

Spectrum of sound

Frequency range Hz	Description	Example
0 - 20	Infrasound	Earth quake
20 - 20.000	Audible sound	Speech, music
> 20.000	Ultrasound	Bat, Quartz crystal

Basic Principles of Ultrasonic Testing

Atomic structures

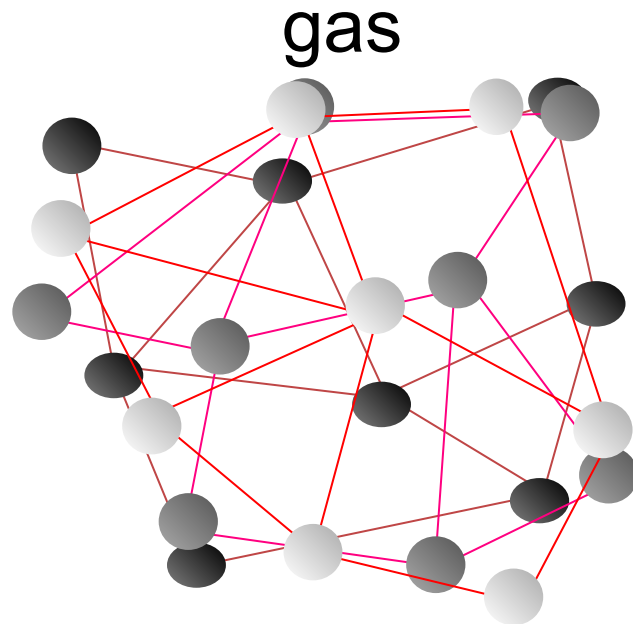

- low density
- weak bonding forces

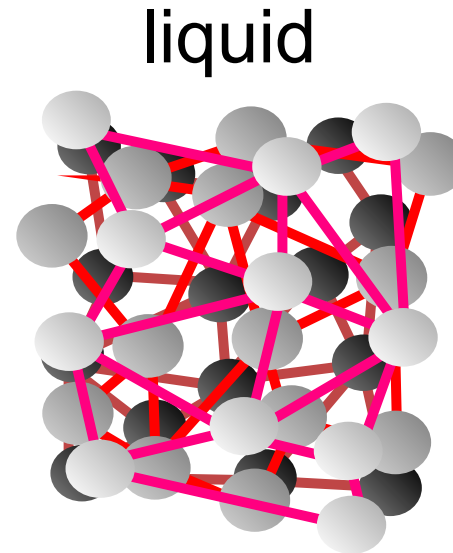

- medium density
- medium bonding forces

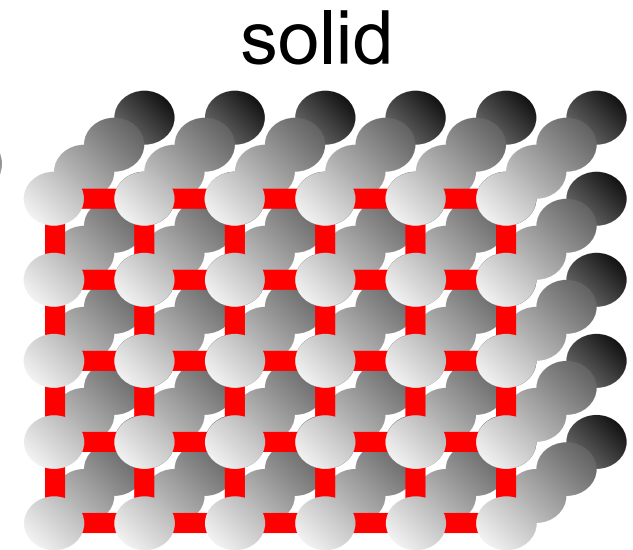

- high density
- strong bonding forces
- crystallographic structure

Basic Principles of Ultrasonic Testing

Understanding wave propagation:

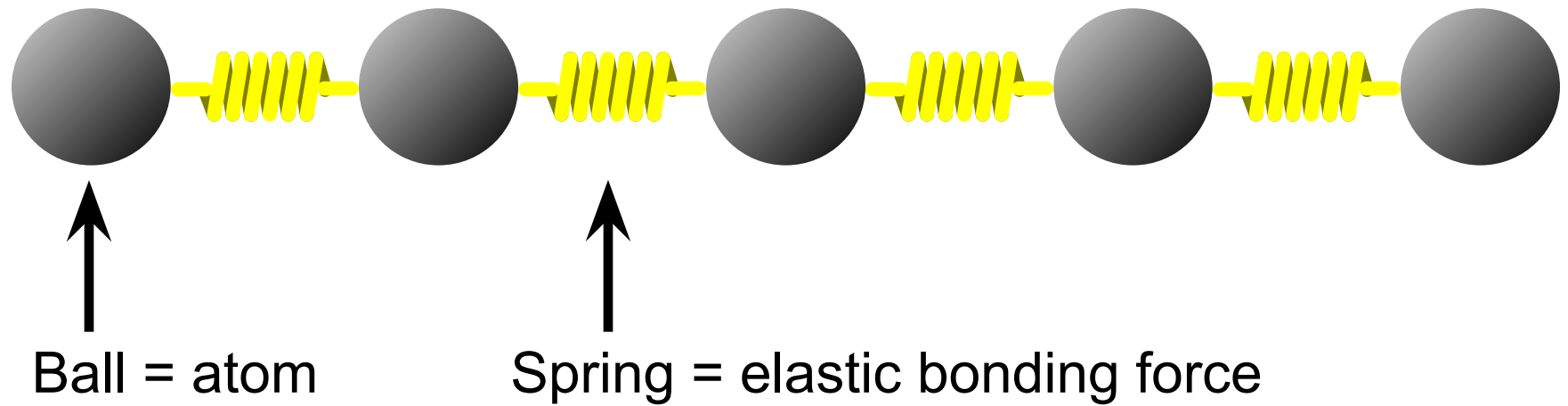

Basic Principles of Ultrasonic Testing

ndt

a worldwide response

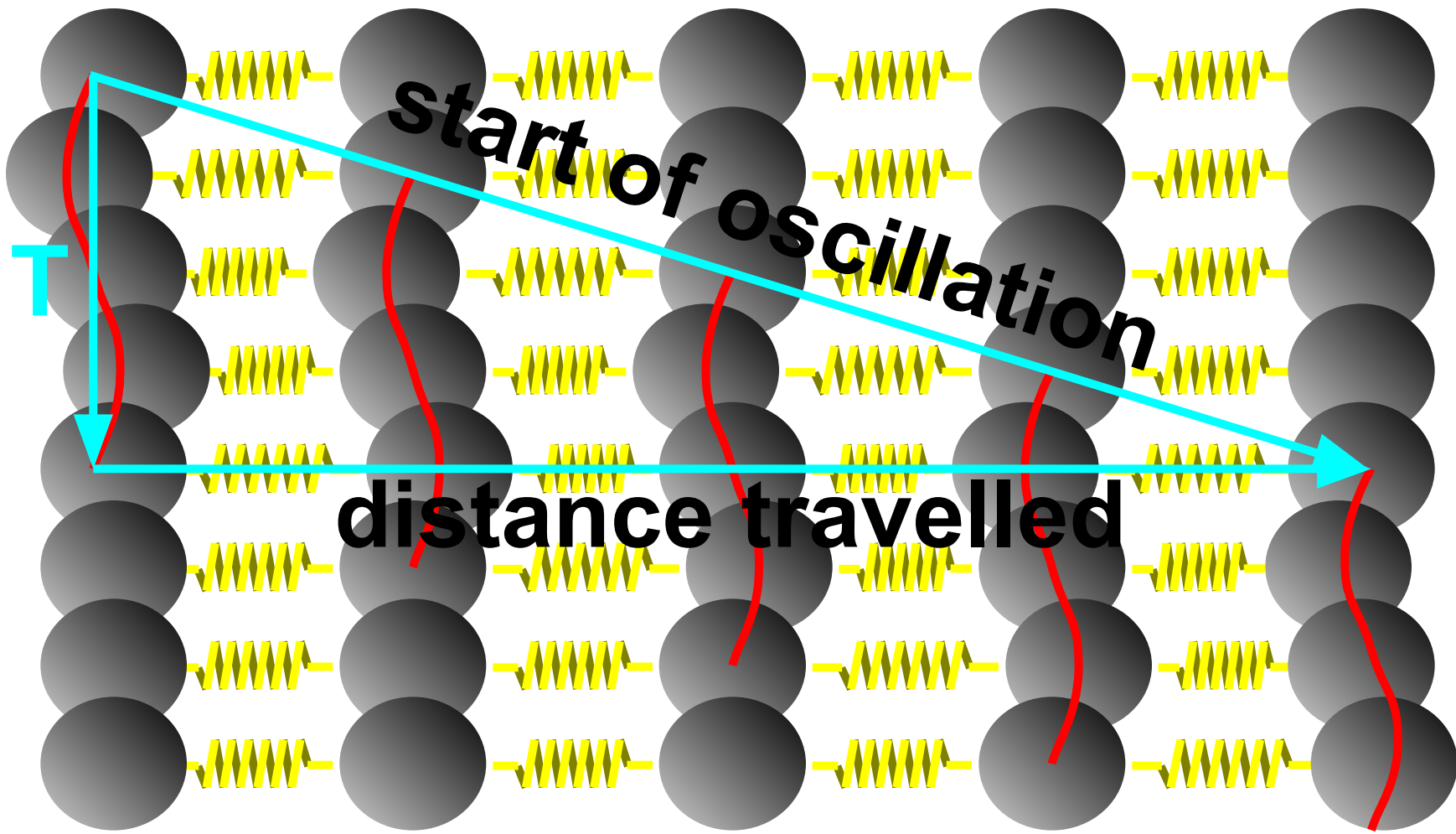

Basic Principles of Ultrasonic Testing

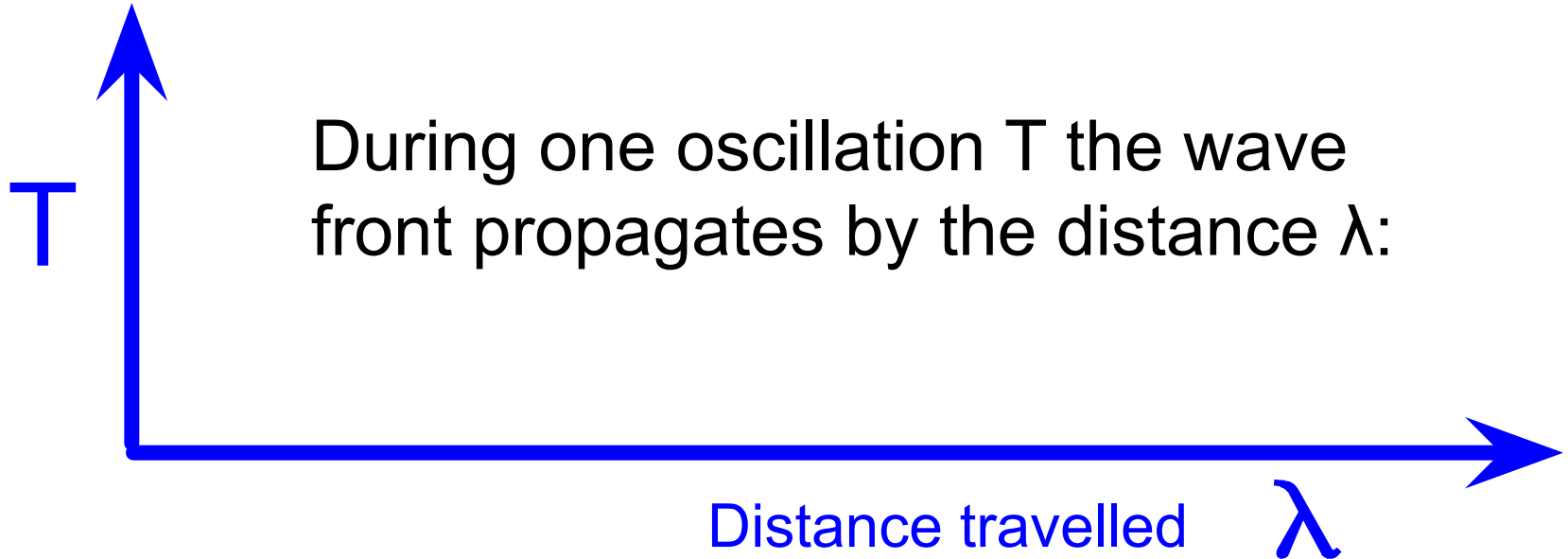

From this we derive:

$$c = \frac{\lambda}{T}$$

or

$$c = \lambda f$$

Wave equation

Basic Principles of Ultrasonic Testing

Sound propagation

Longitudinal wave

Direction of oscillation

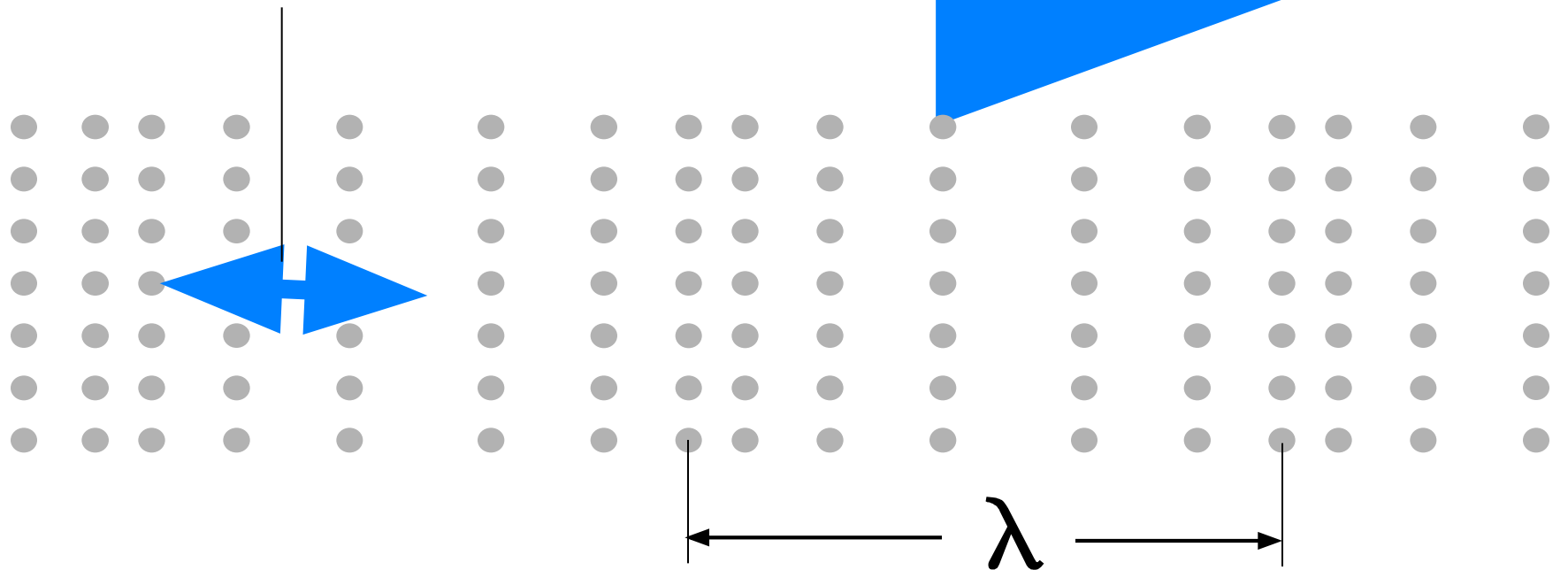

Basic Principles of Ultrasonic Testing

Sound propagation

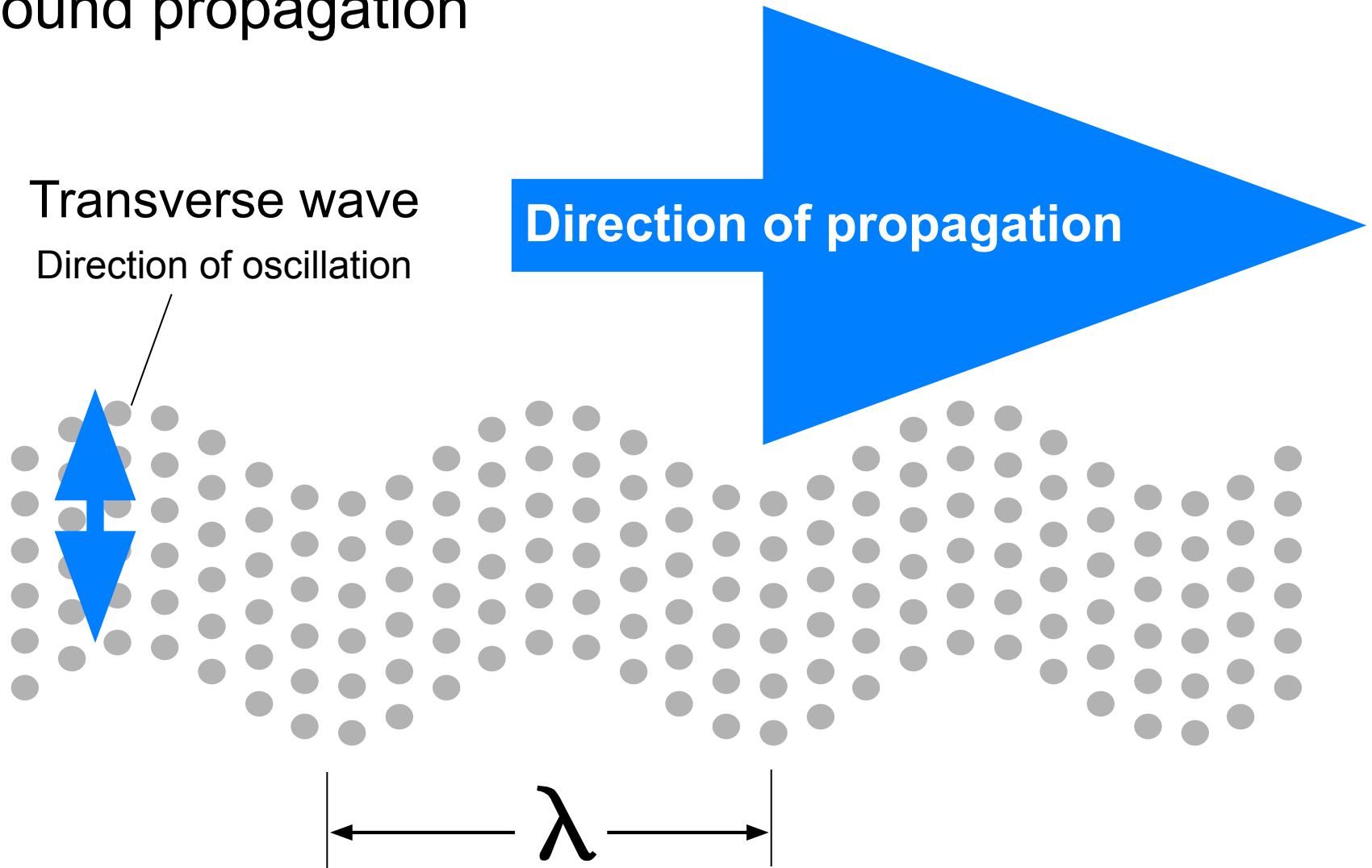

Basic Principles of Ultrasonic Testing

Wave propagation

Longitudinal waves propagate in all kind of materials.

Transverse waves only propagate in solid bodies.

Due to the different type of oscillation, transverse waves travel at lower speeds.

Sound velocity mainly depends on the density and E-modulus of the material.

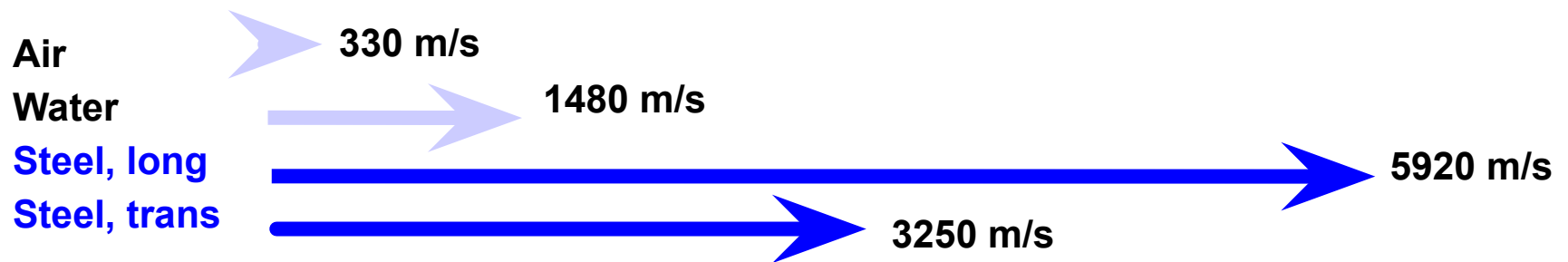

Basic Principles of Ultrasonic Testing

Reflection and Transmission

As soon as a sound wave comes to a change in material characteristics ,e.g. the surface of a workpiece, or an internal inclusion, wave propagation will change too:

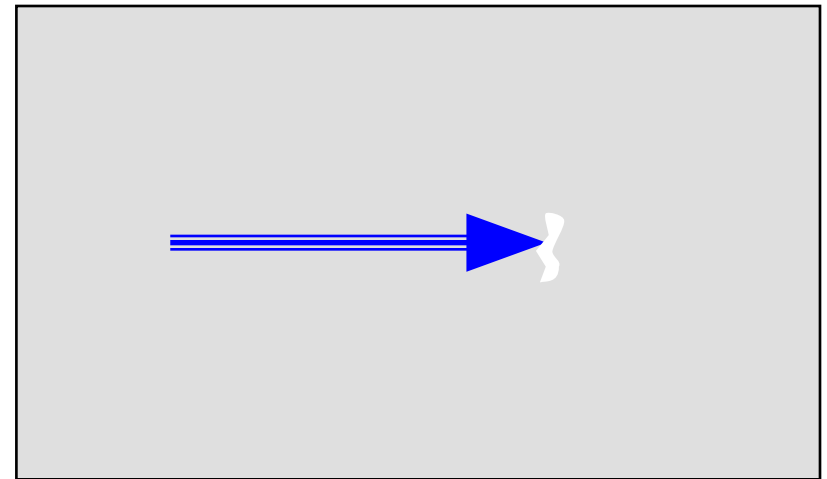
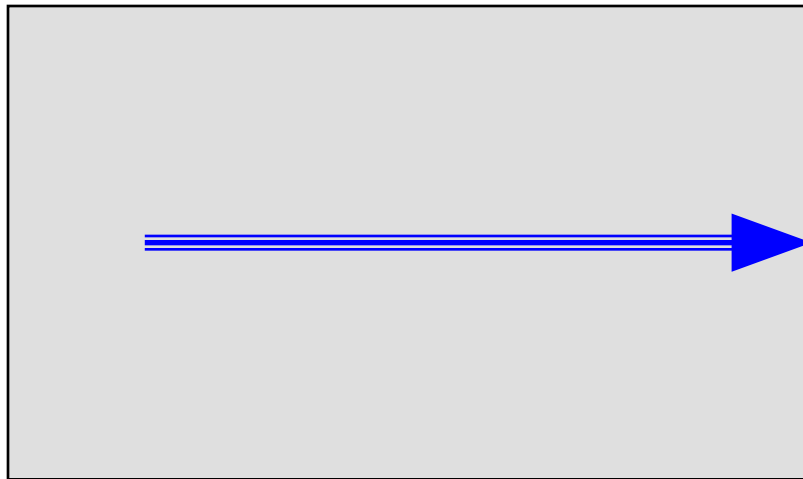

Basic Principles of Ultrasonic Testing

Behaviour at an interface

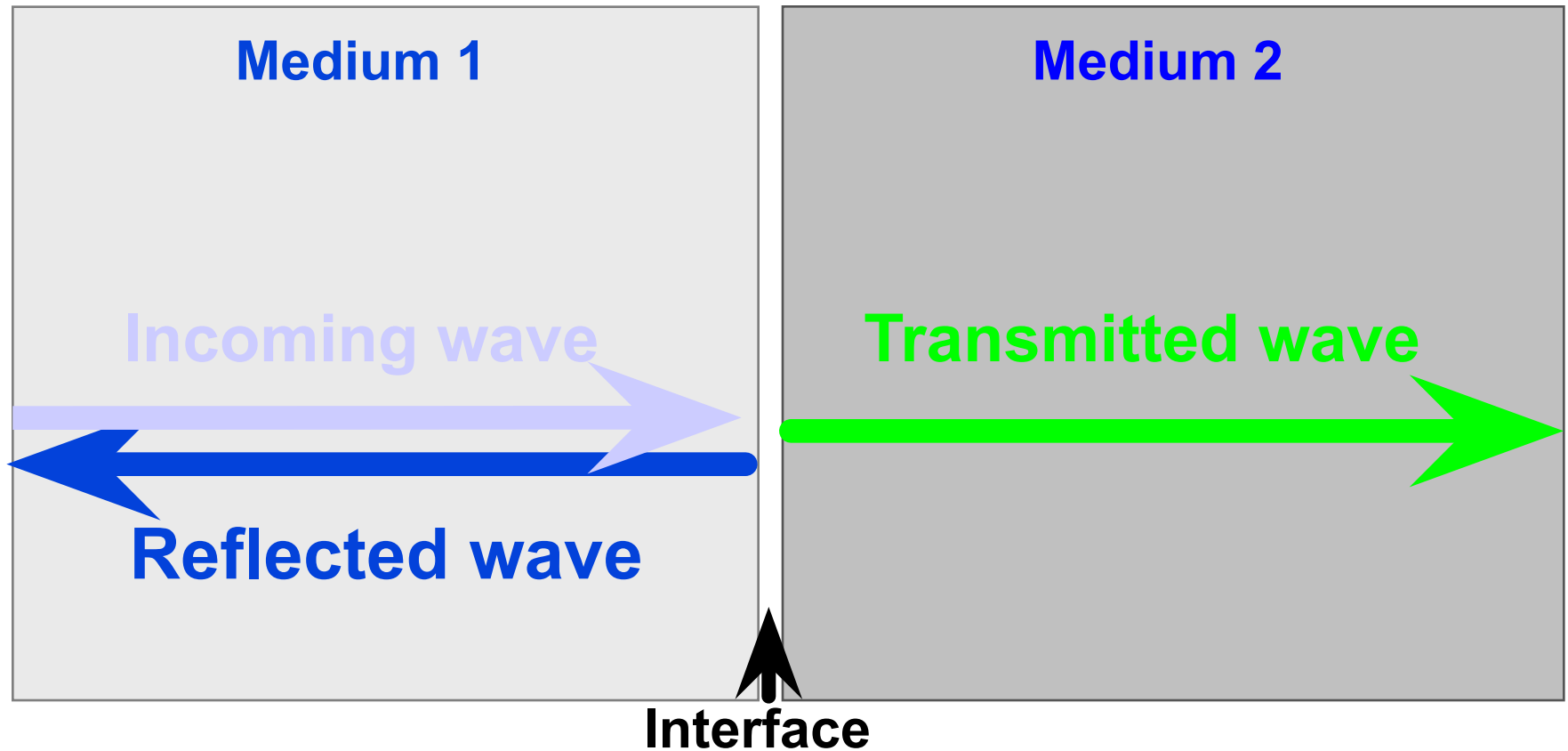

Basic Principles of Ultrasonic Testing

Reflection + Transmission: Perspex - Steel

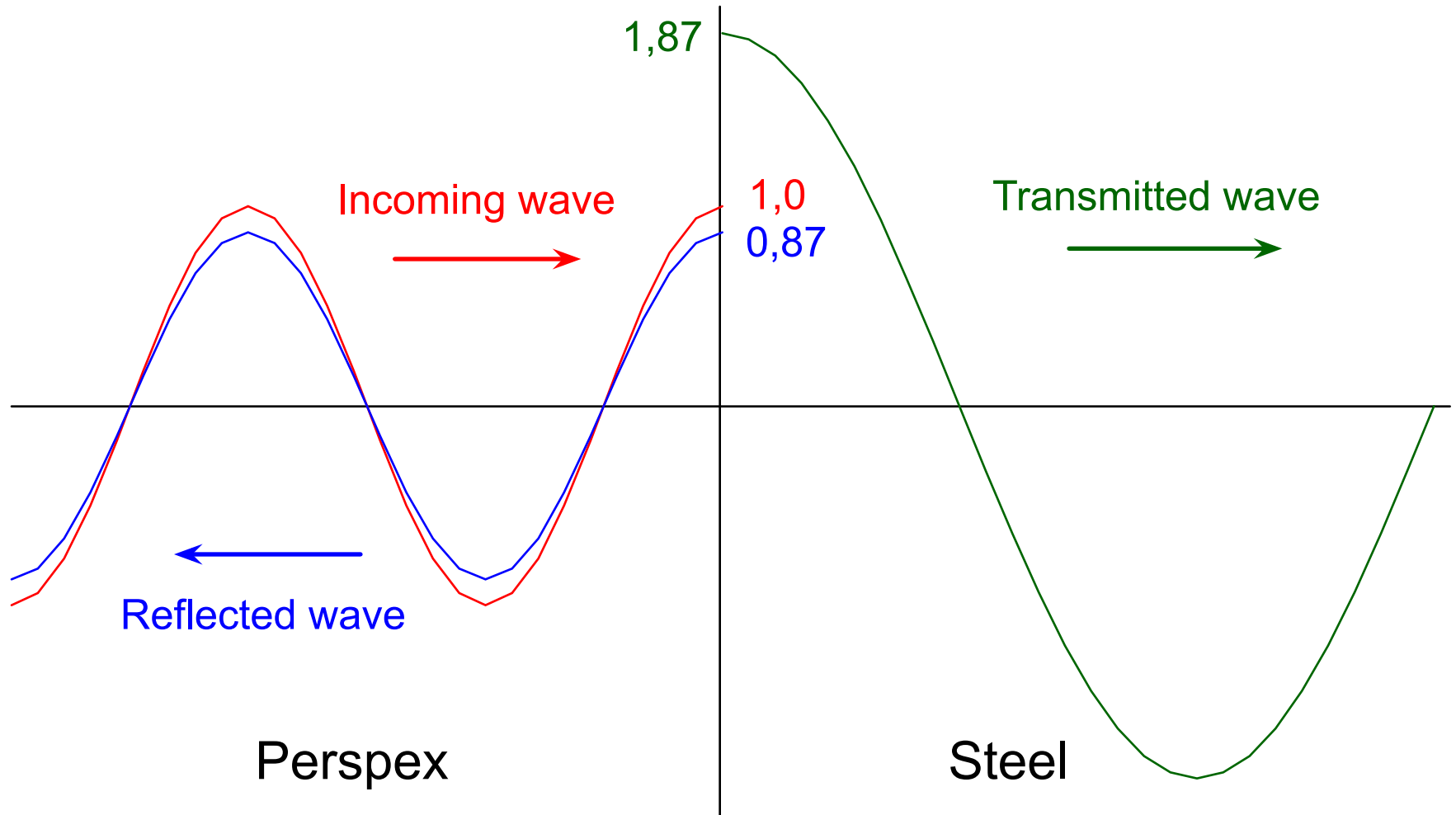

Basic Principles of Ultrasonic Testing

Reflection + Transmission: Steel - Perspex

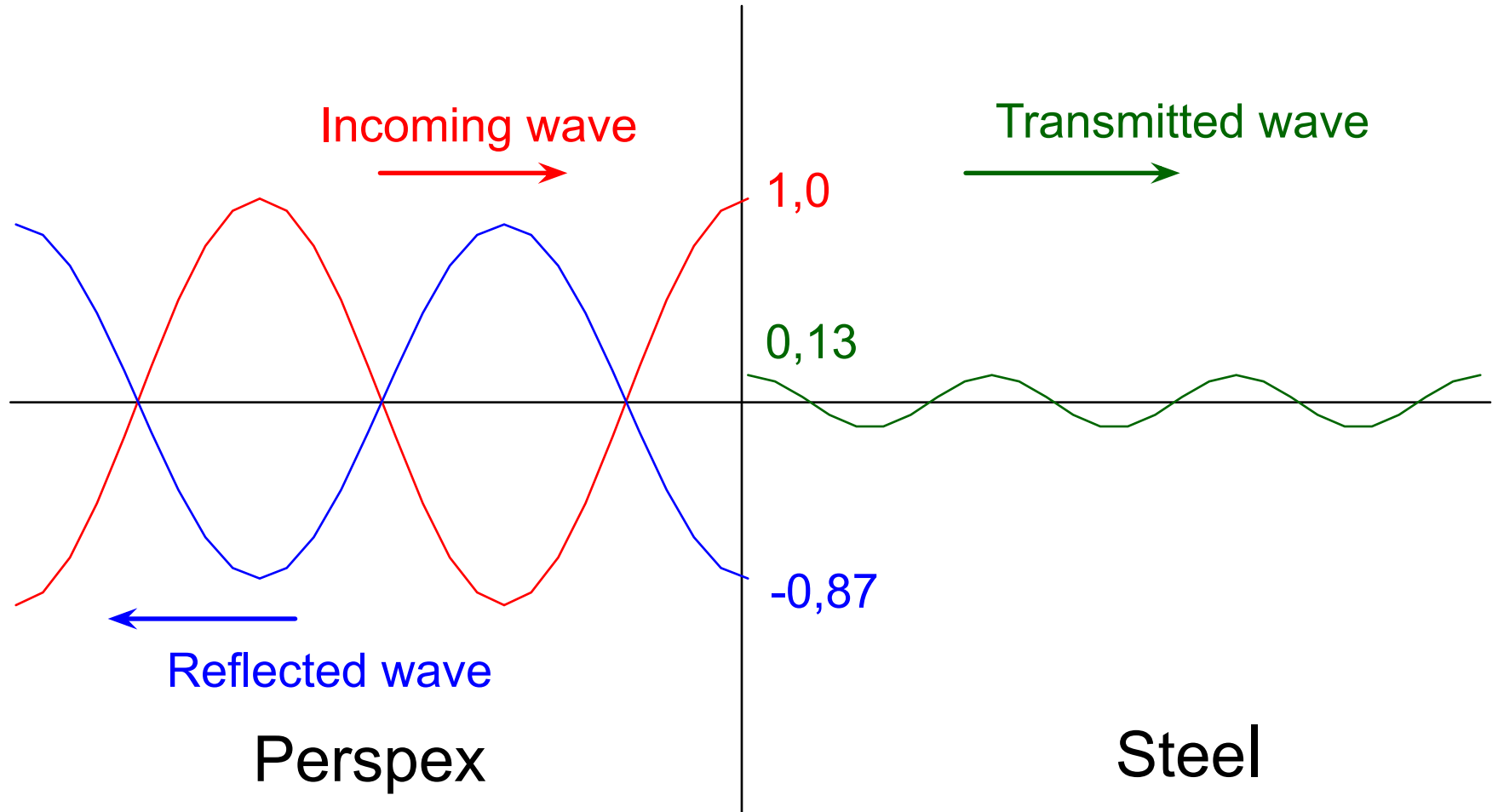

Basic Principles of Ultrasonic Testing

Amplitude of sound transmissions:

Water - Steel	Copper - Steel	Steel - Air
<ul style="list-style-type: none">• Strong reflection• Double transmission	<ul style="list-style-type: none">• No reflection• Single transmission	<ul style="list-style-type: none">• Strong reflection with inverted phase• No transmission

Basic Principles of Ultrasonic Testing

Piezoelectric Effect

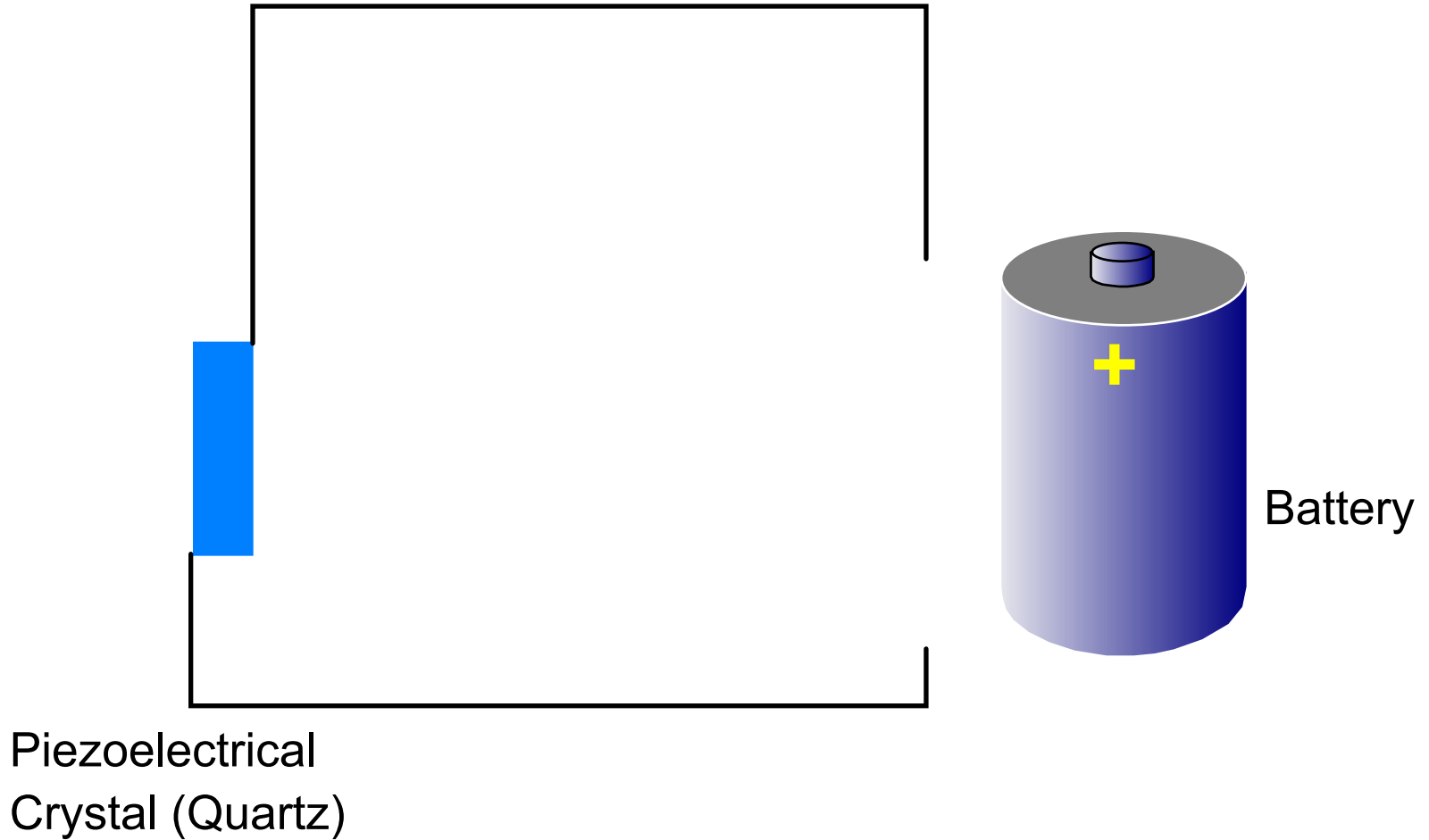

Basic Principles of Ultrasonic Testing

Piezoelectric Effect

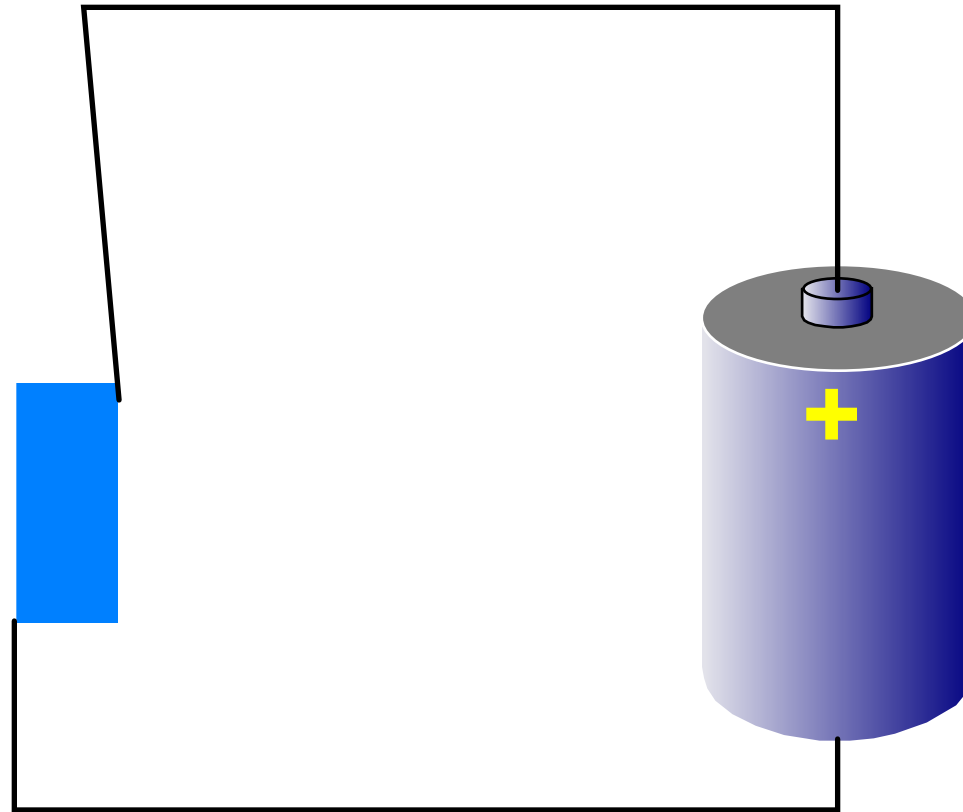

The crystal gets thicker, due to a distortion of the crystal lattice

Basic Principles of Ultrasonic Testing

Piezoelectric Effect

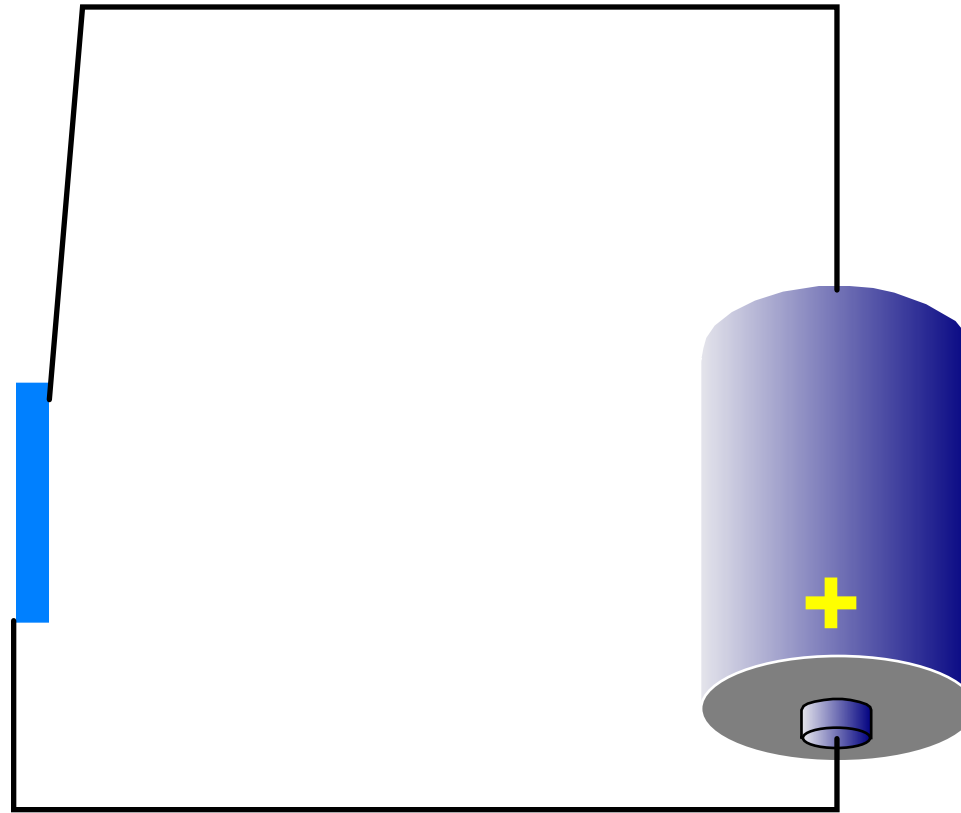

The effect inverses with polarity change

Basic Principles of Ultrasonic Testing

Piezoelectric Effect

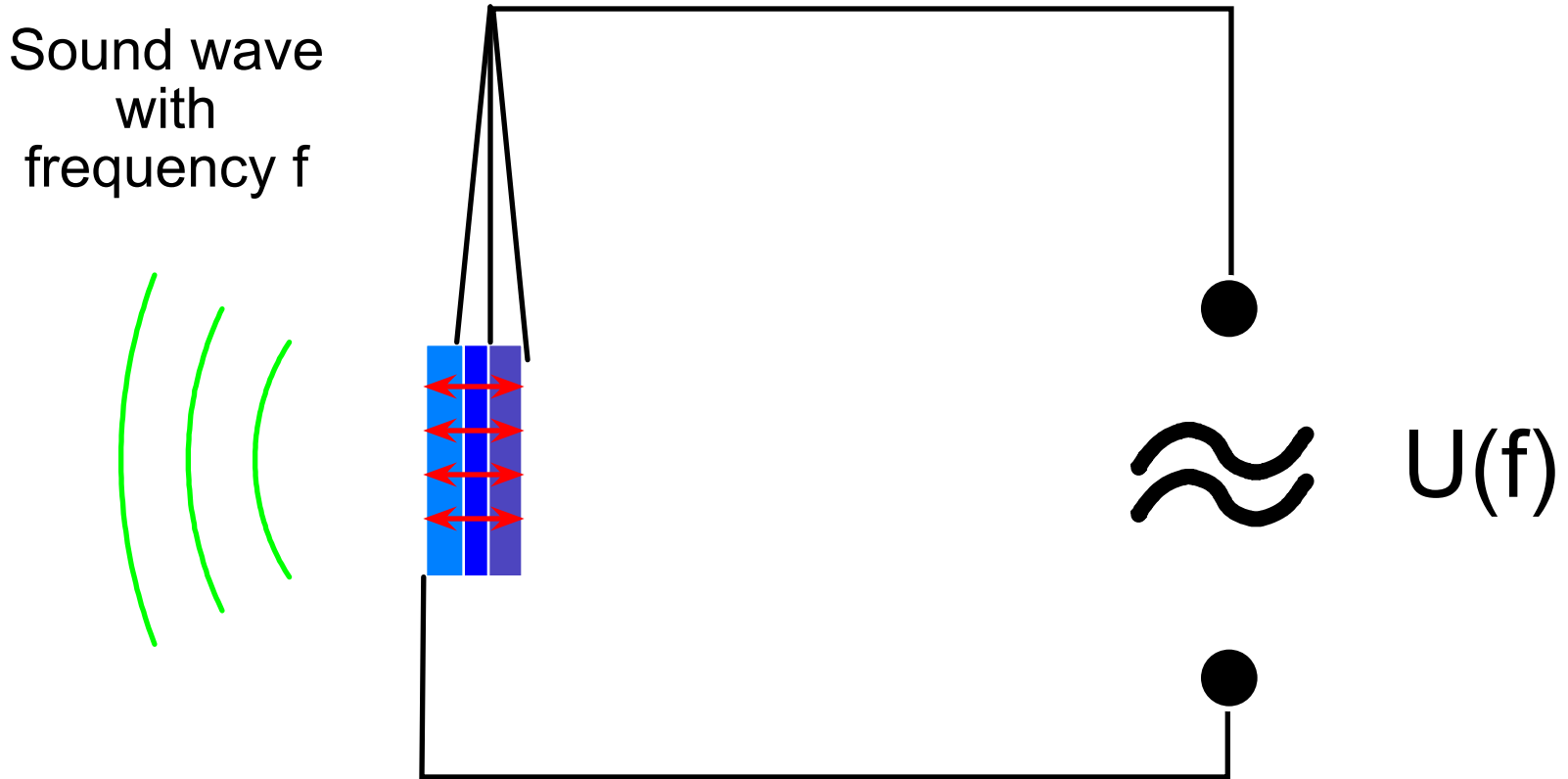

An alternating voltage generates crystal oscillations at the frequency f

Basic Principles of Ultrasonic Testing

Piezoelectric Effect

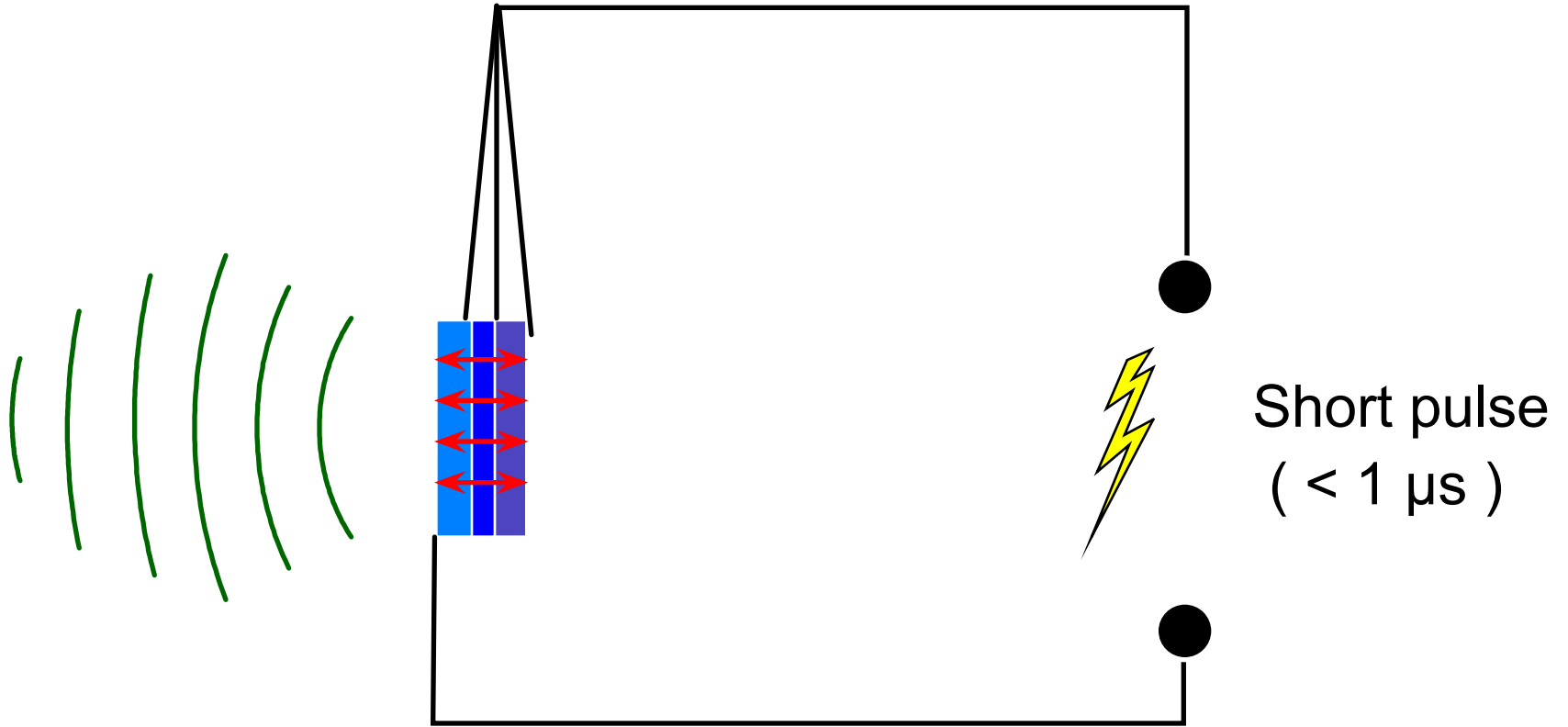

A short voltage pulse generates an oscillation at the crystal's resonant frequency f_0

Basic Principles of Ultrasonic Testing

Reception of ultrasonic waves

A sound wave hitting a piezoelectric crystal, induces crystal vibration which then causes electrical voltages at the crystal surfaces.

Electrical energy



Piezoelectrical crystal



Ultrasonic wave

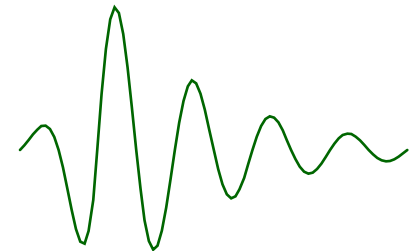

Basic Principles of Ultrasonic Testing

Ultrasonic Probes

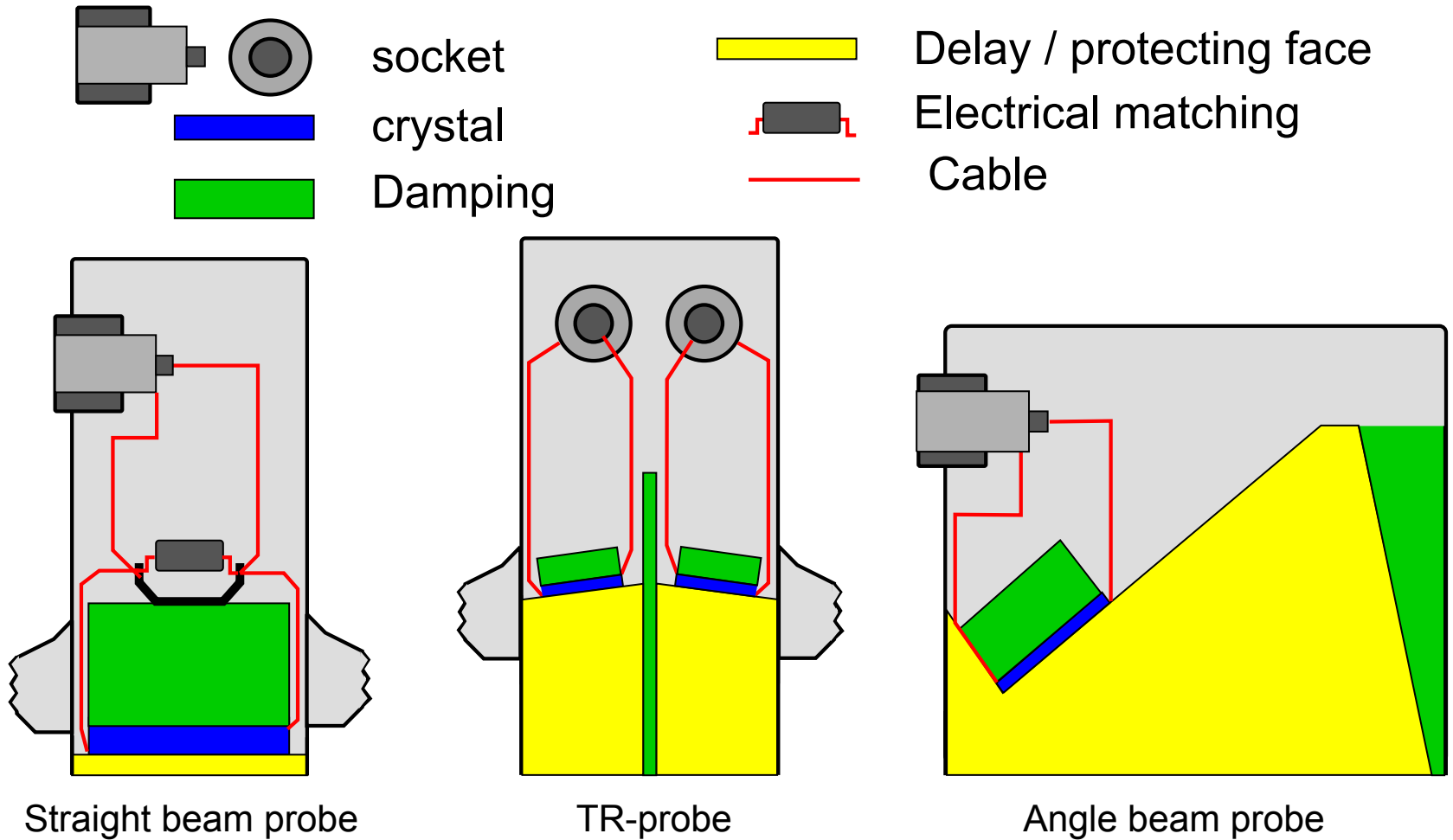

Basic Principles of Ultrasonic Testing

RF signal (short)

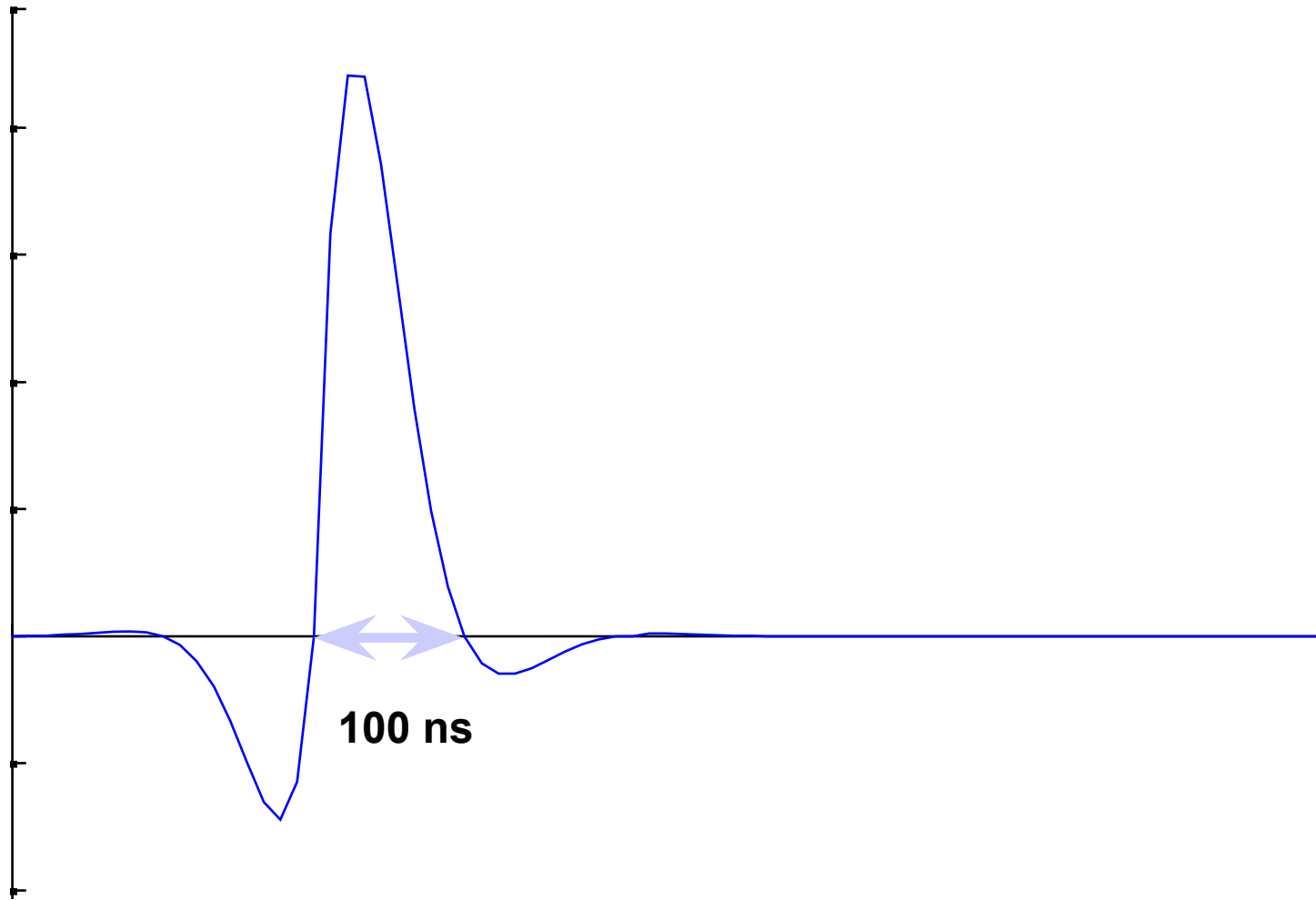

Basic Principles of Ultrasonic Testing

RF signal (medium)

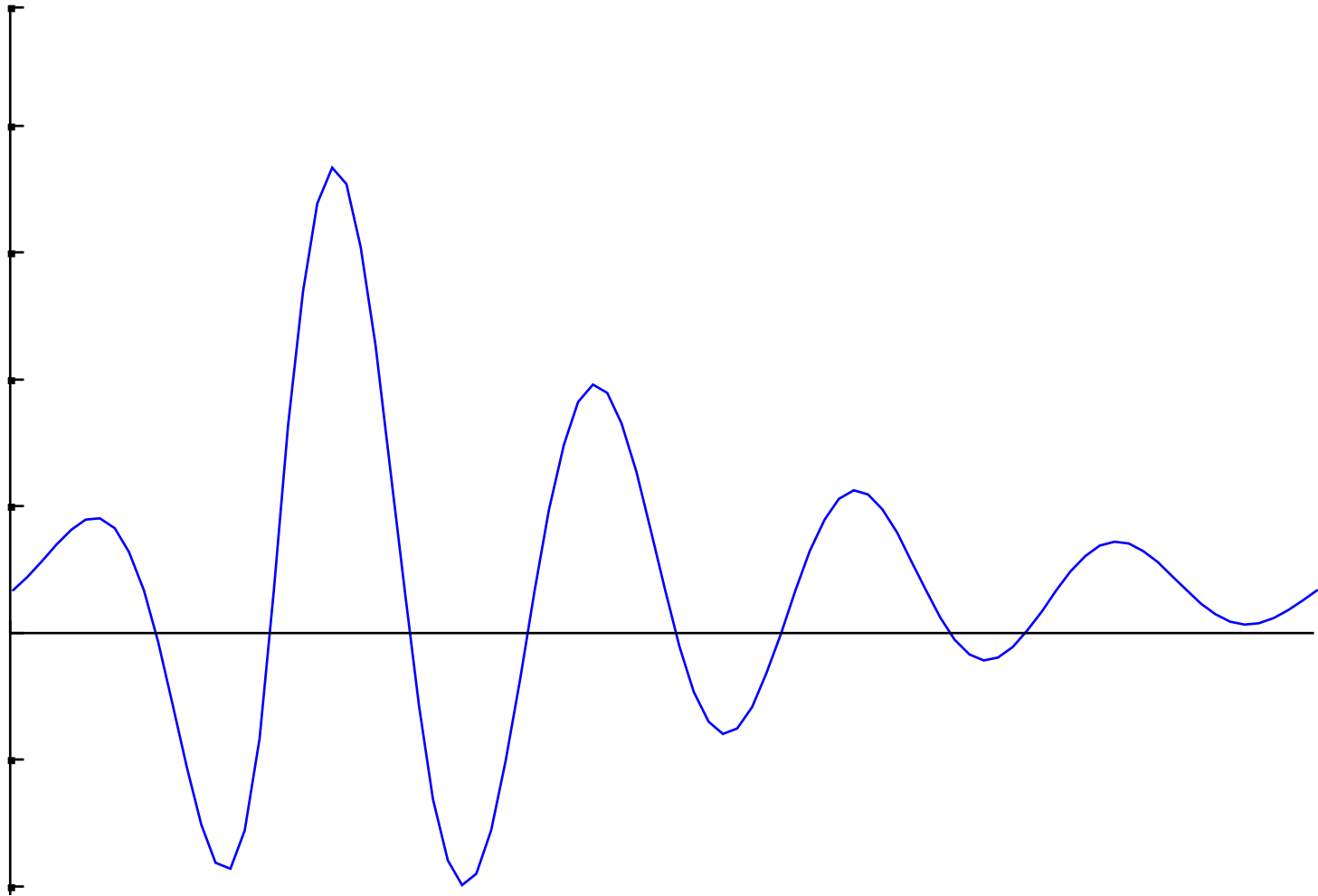

Basic Principles of Ultrasonic Testing

Sound field

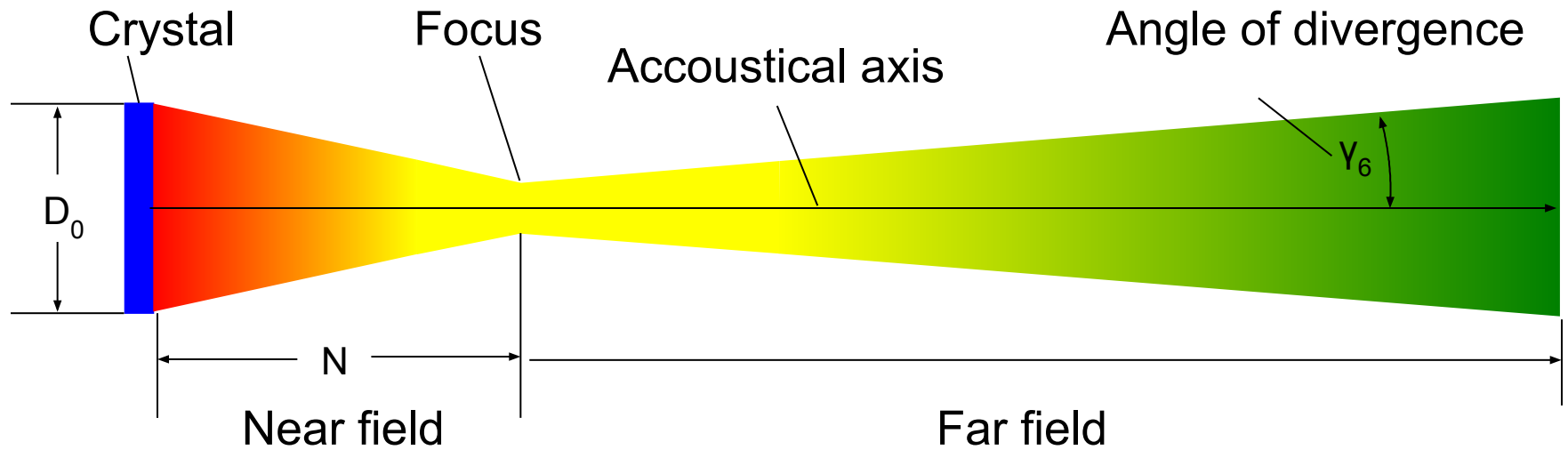

Basic Principles of Ultrasonic Testing

Ultrasonic Instrument

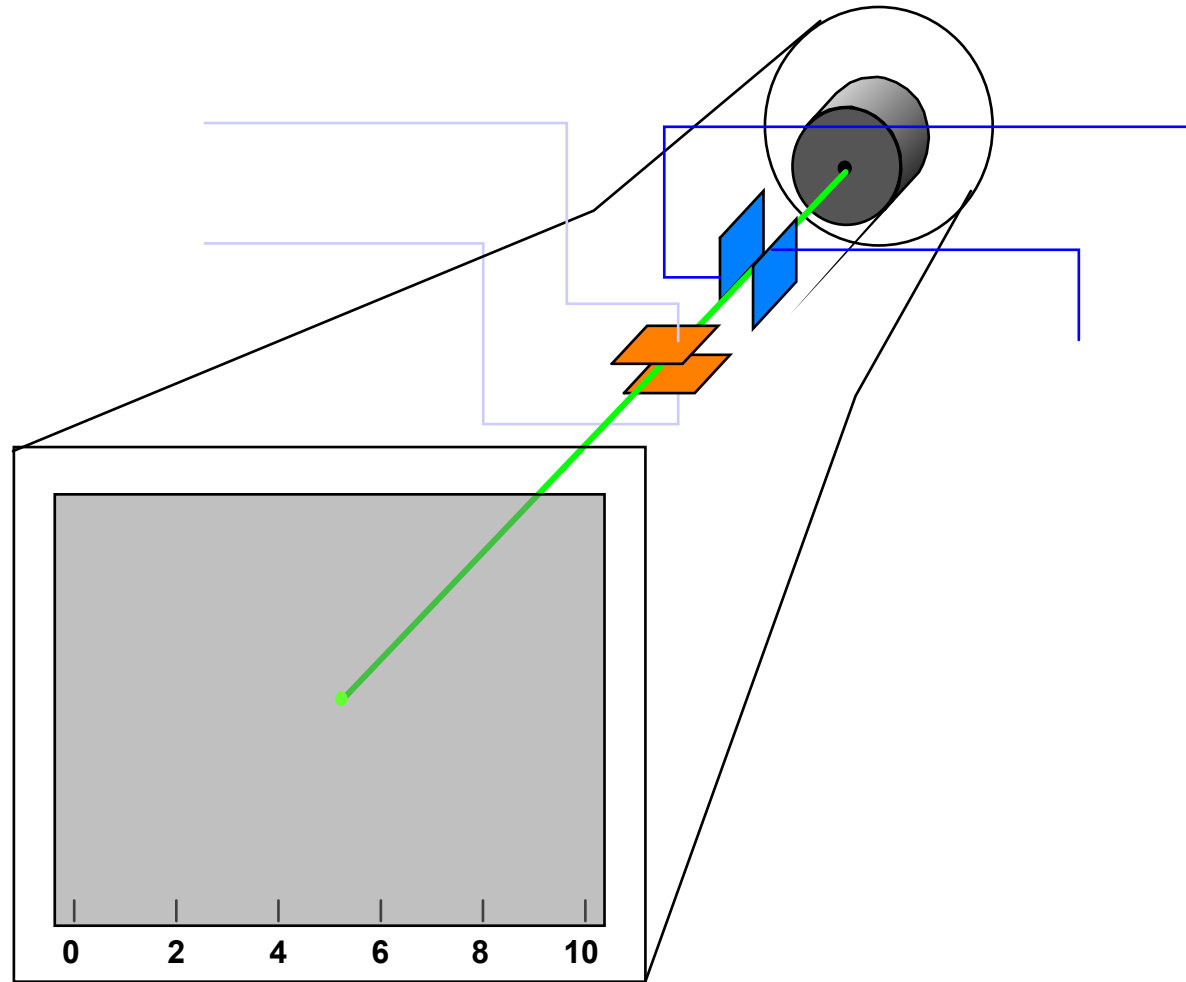

Basic Principles of Ultrasonic Testing

Ultrasonic Instrument

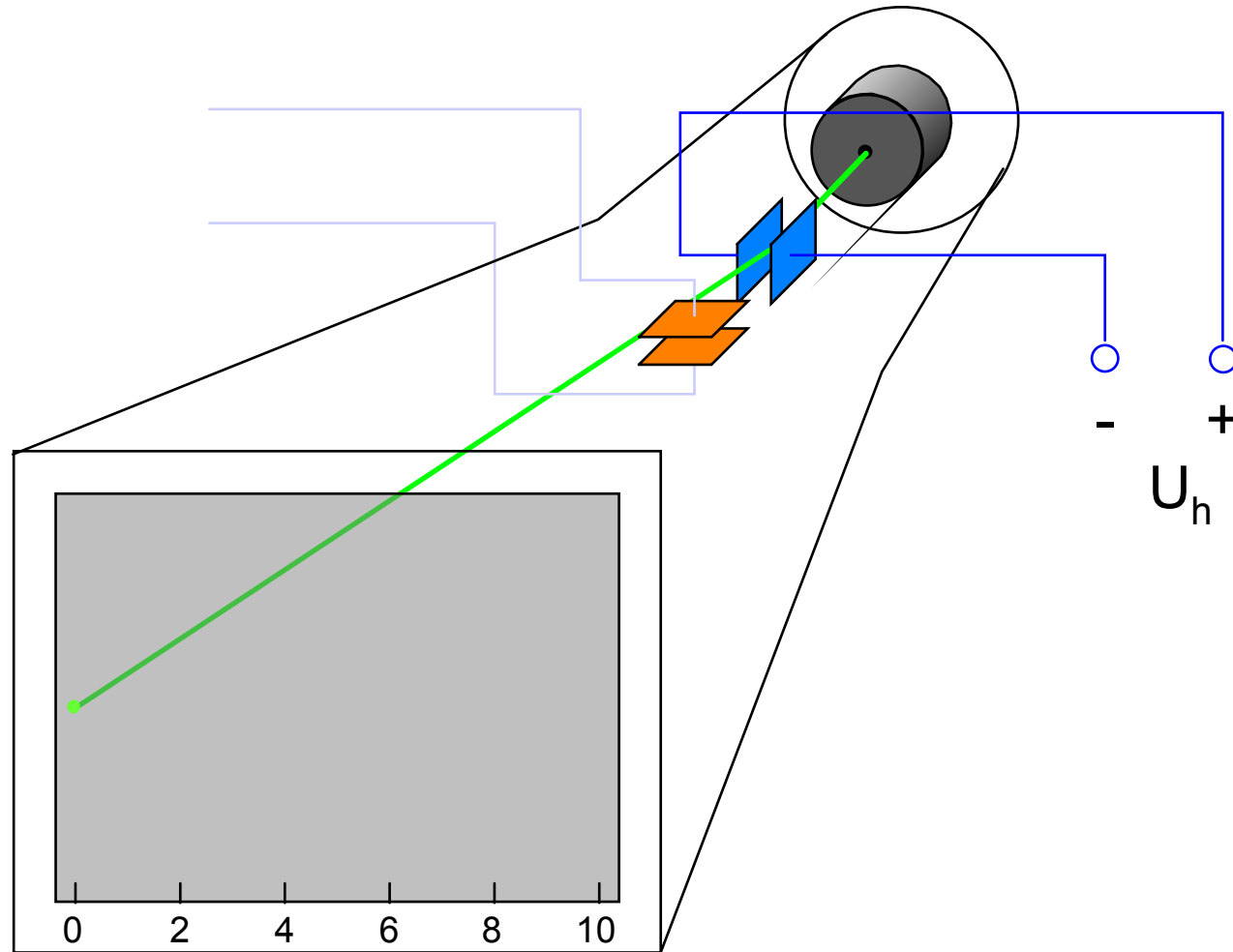

Basic Principles of Ultrasonic Testing

Ultrasonic Instrument

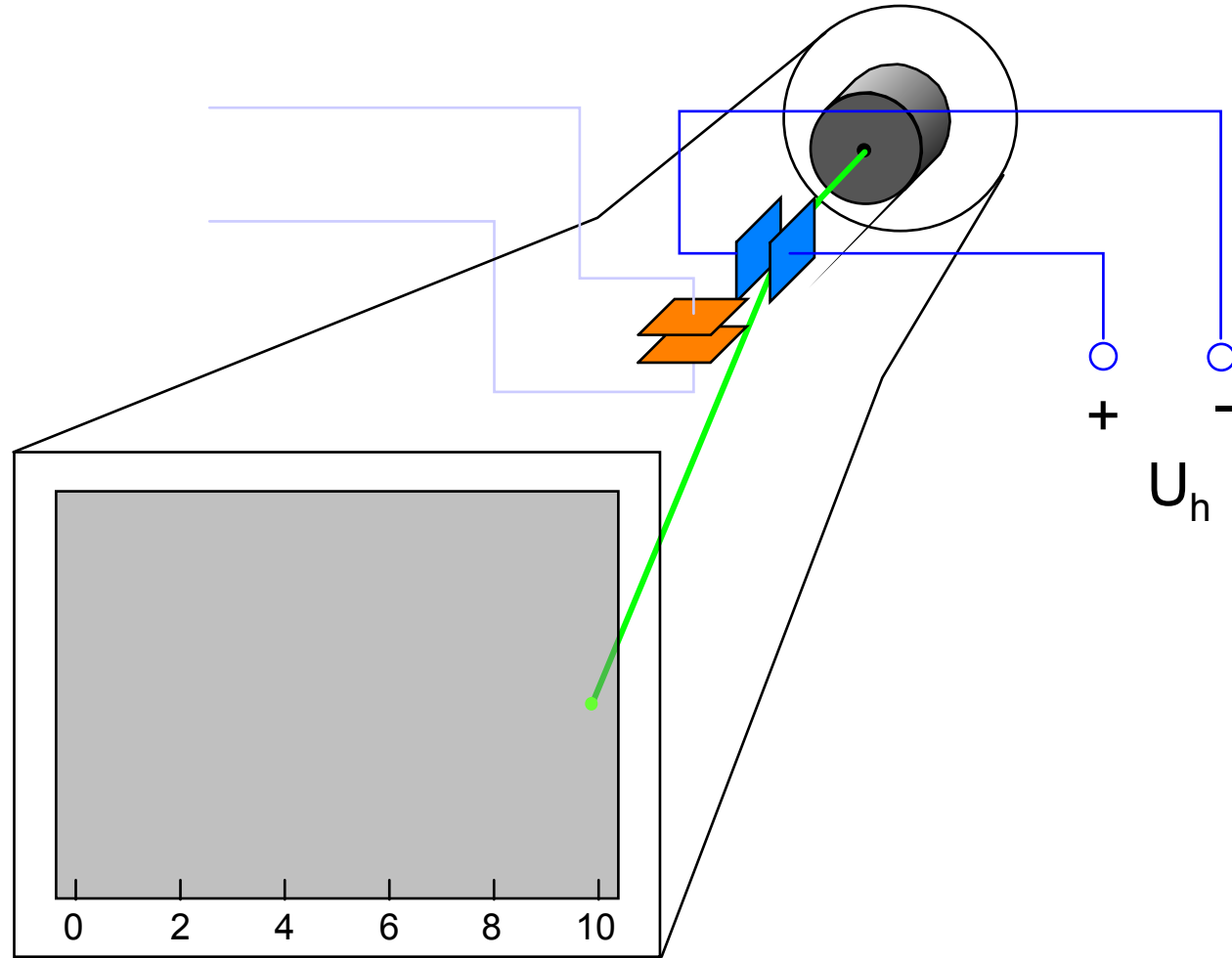

Basic Principles of Ultrasonic Testing

Ultrasonic Instrument

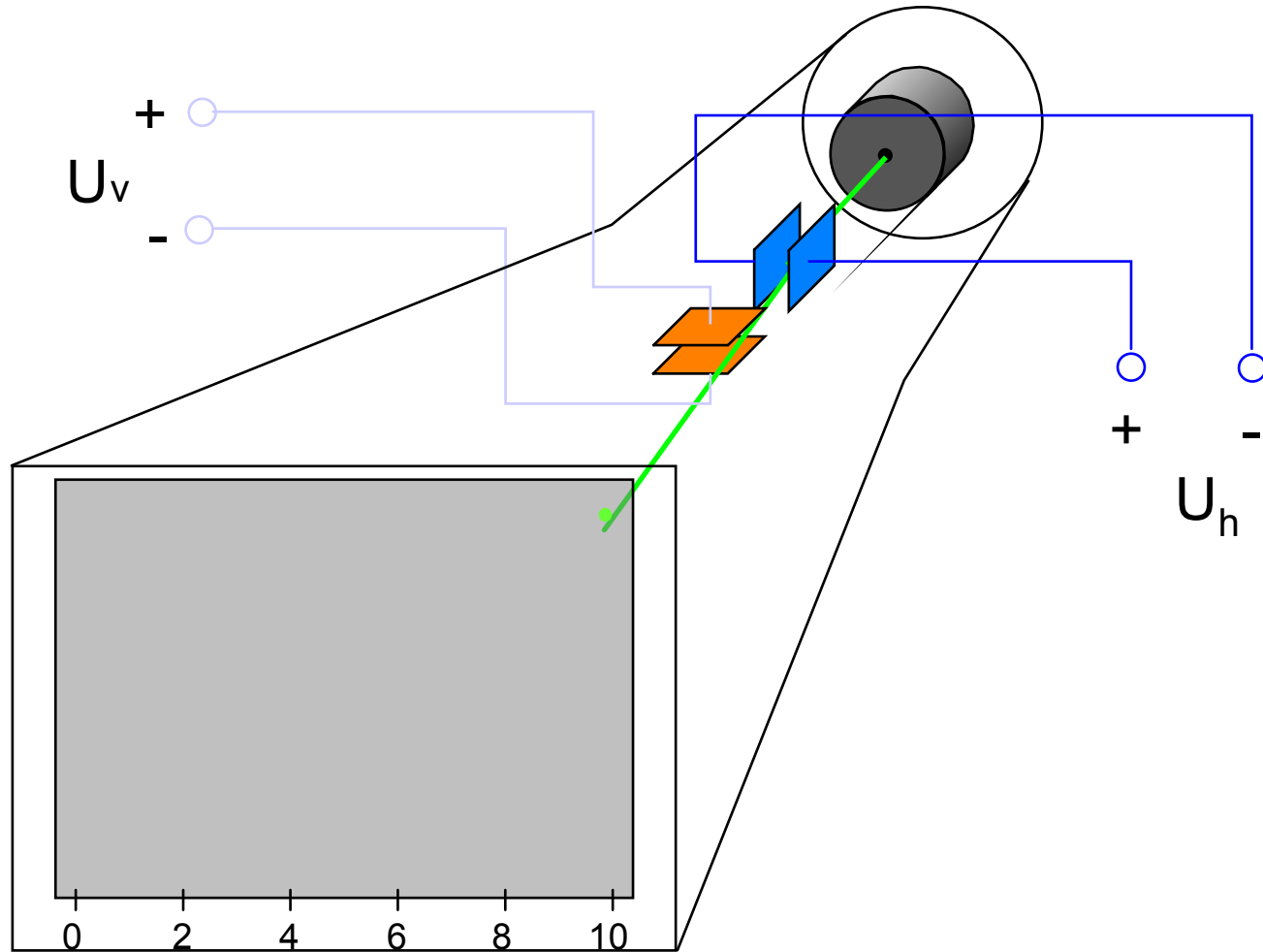

Basic Principles of Ultrasonic Testing

Block diagram: Ultrasonic Instrument

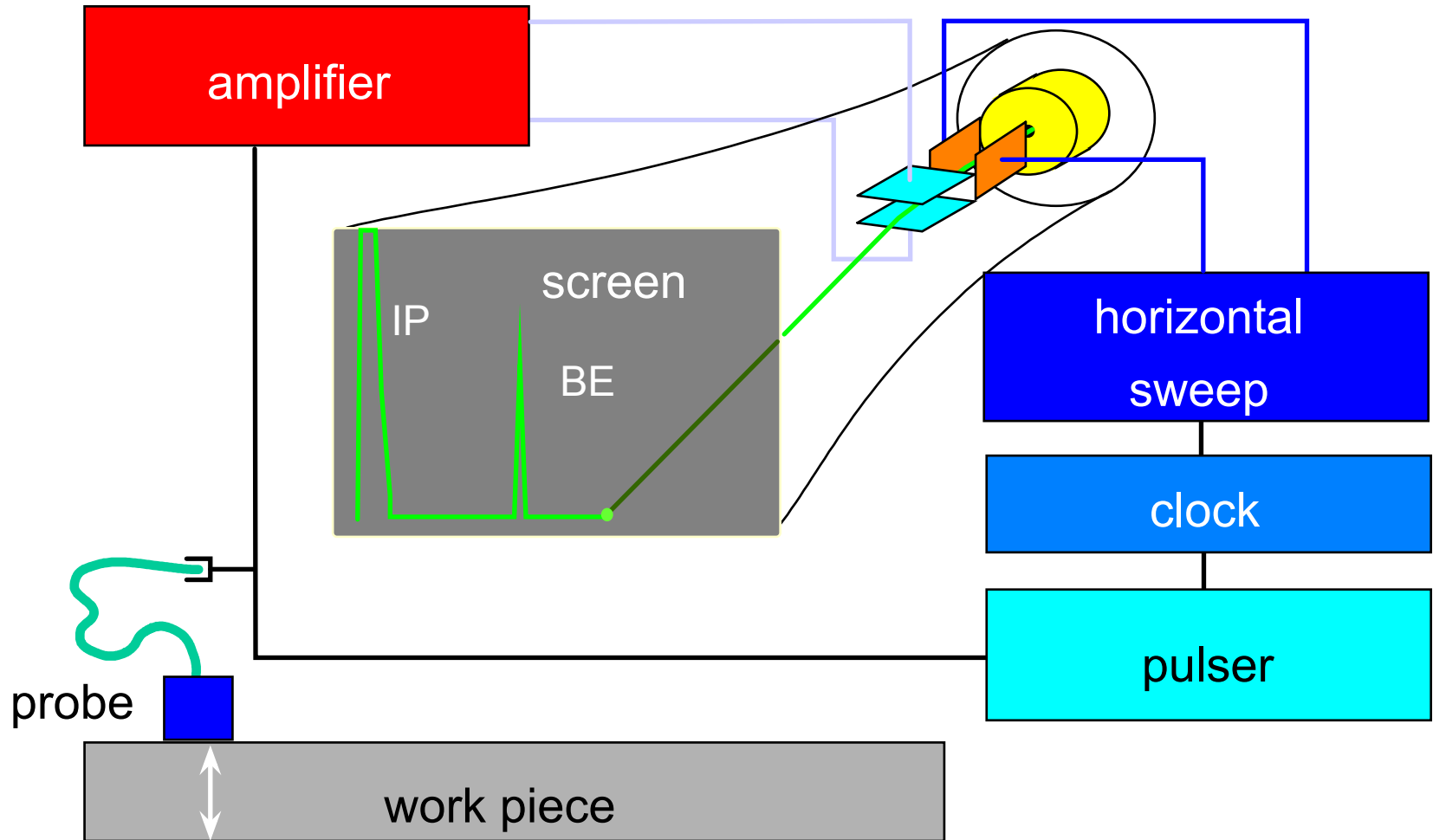

Basic Principles of Ultrasonic Testing

Sound reflection at a flaw

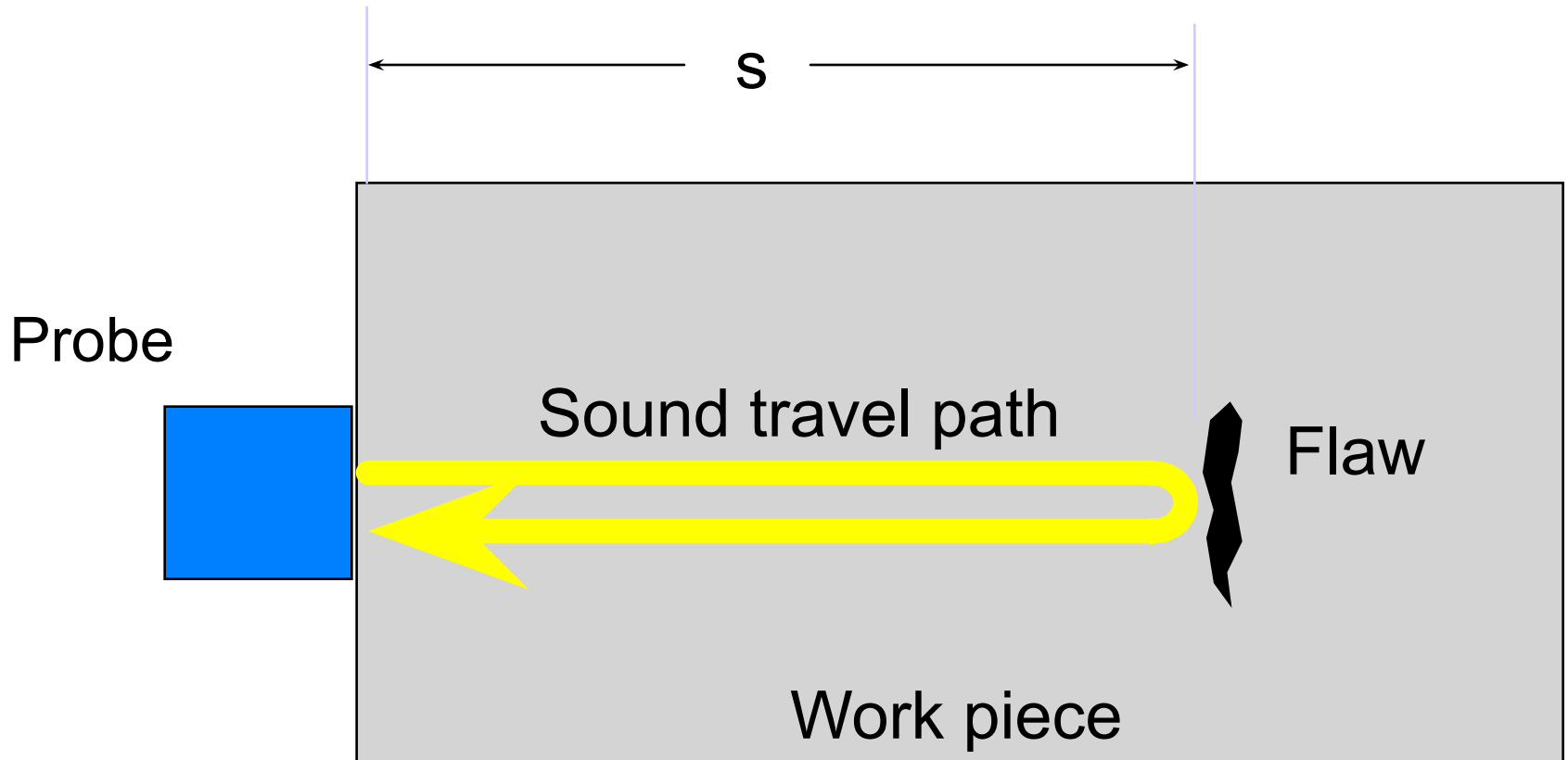

Basic Principles of Ultrasonic Testing

Plate testing

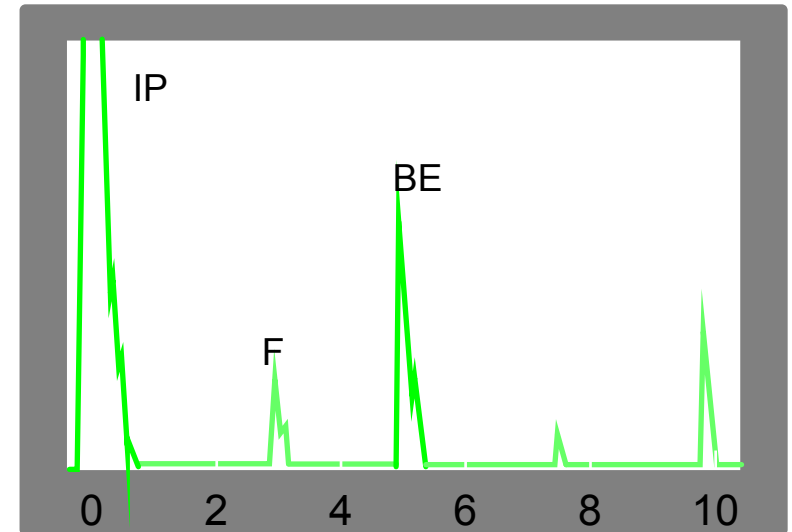
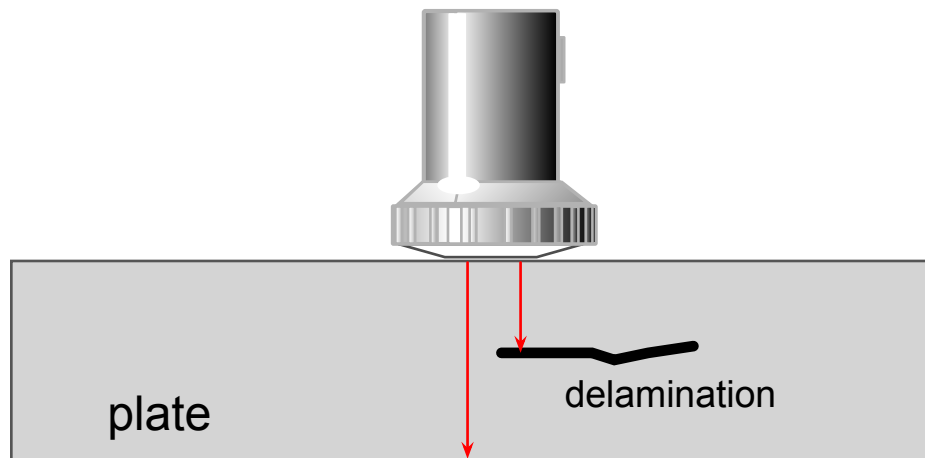

IP = Initial pulse

F = Flaw

BE = Backwall echo

Basic Principles of Ultrasonic Testing

Wall thickness measurement

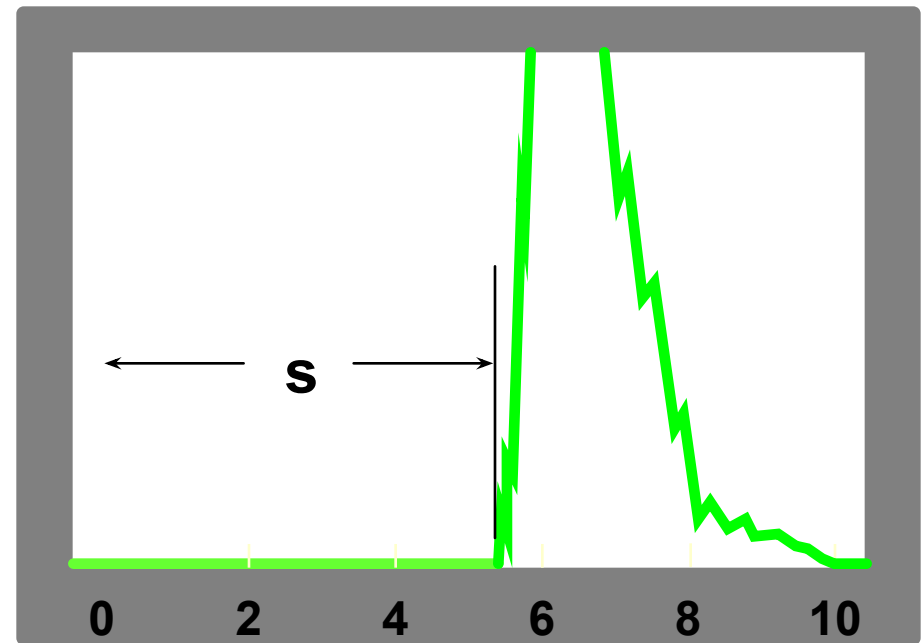
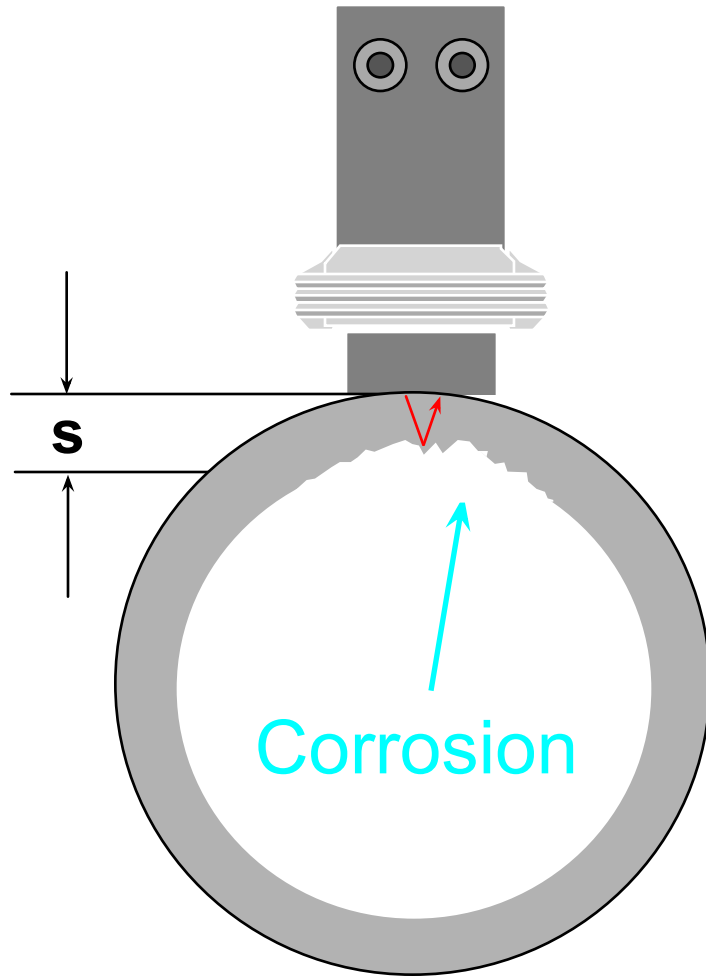

Basic Principles of Ultrasonic Testing

Through transmission testing

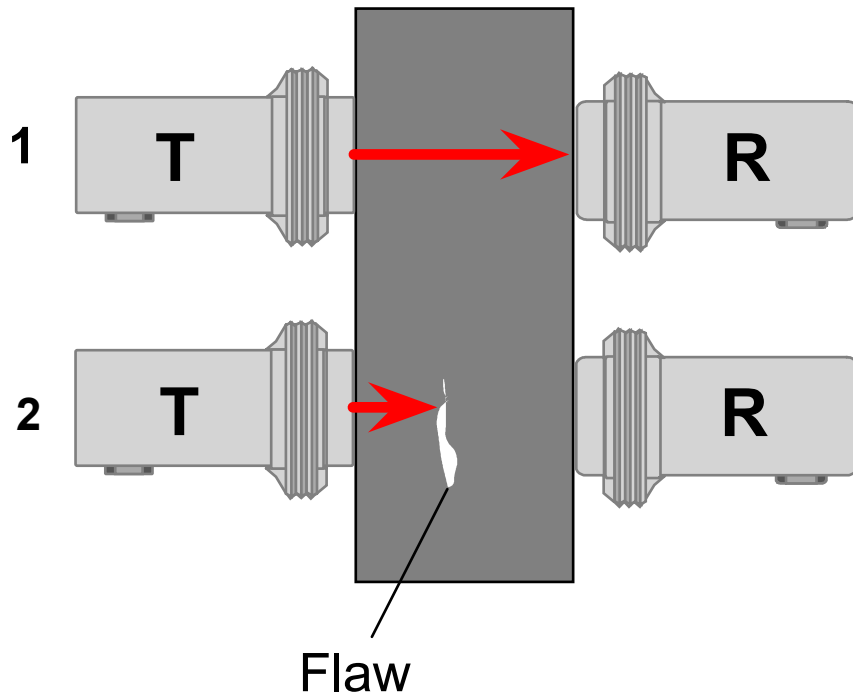

Through transmission signal

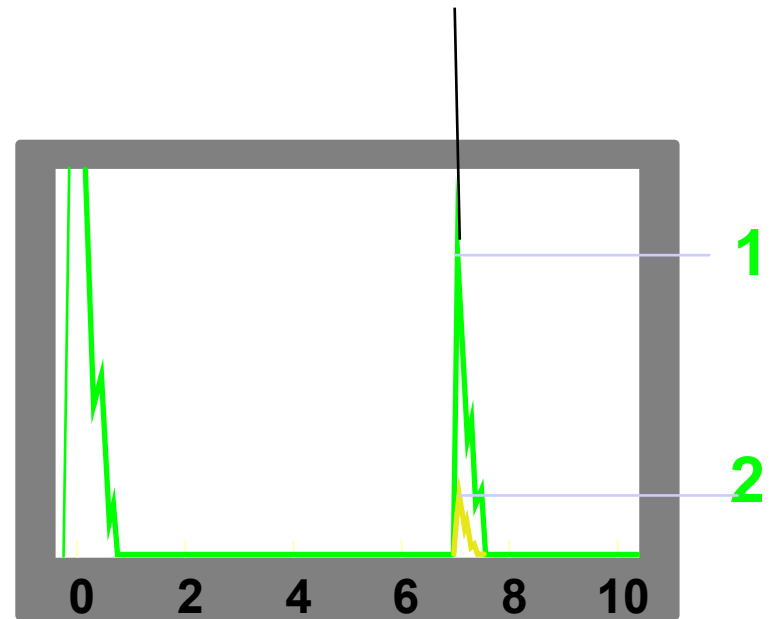

Basic Principles of Ultrasonic Testing

Weld inspection

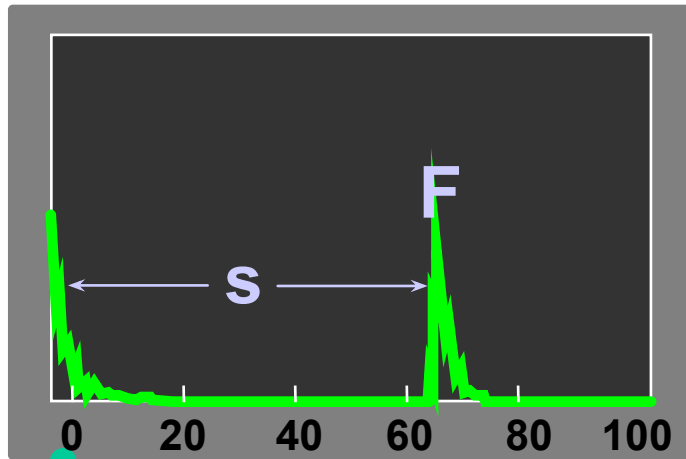

$$a = s \sin \beta$$

$$a' = a - x$$

$$d' = s \cos \beta$$

$$d = 2T - t'$$

- β = probe angle
- s = sound path
- a = surface distance
- a' = reduced surface distance
- d' = virtual depth
- d = actual depth
- T = material thickness

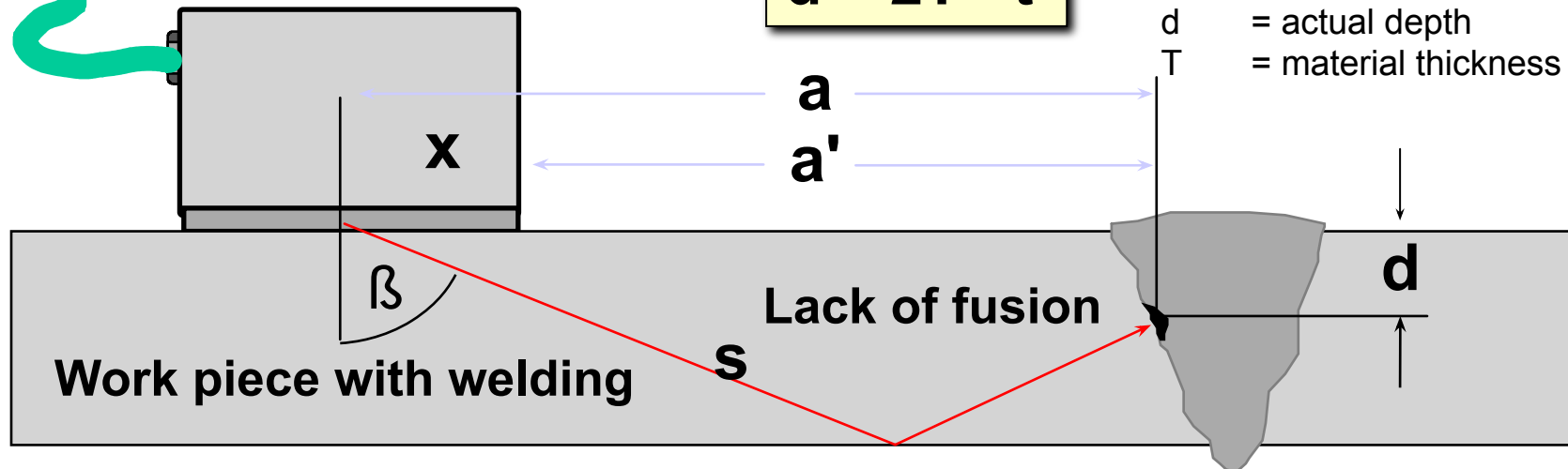

Basic Principles of Ultrasonic Testing

Straight beam inspection techniques:

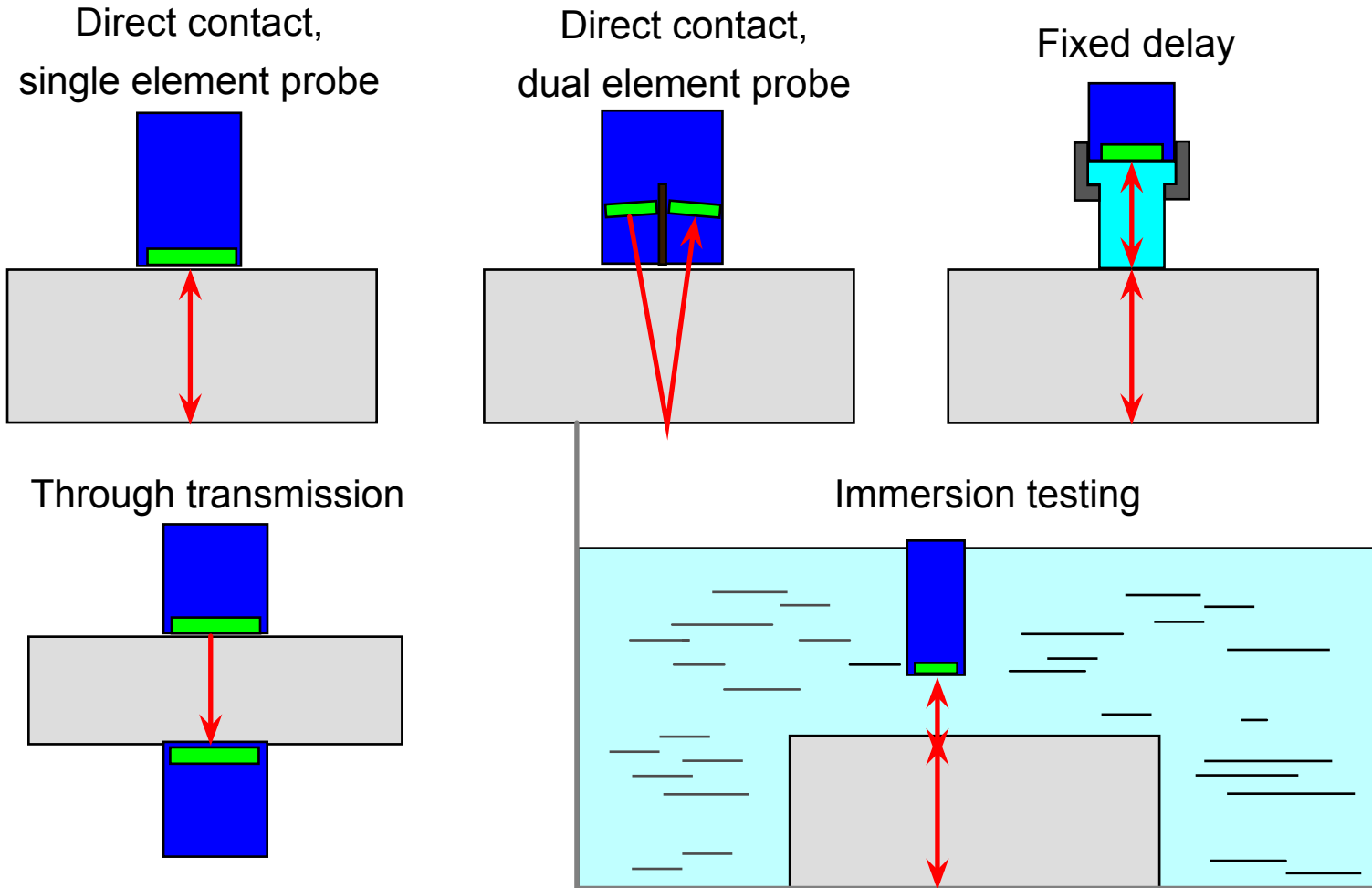

Basic Principles of Ultrasonic Testing

Immersion testing

