

# Мікропроцесорна техніка

(лекція 3)  
Благітко Б.Я.  
2019 р.

**PSoC Creator 4.2**  
**Designing with PSoC 3/5**



# PSoC@3/5 CapSense

PSoC Creator 4.2  
Designing with PSoC 3/5



# CapSense

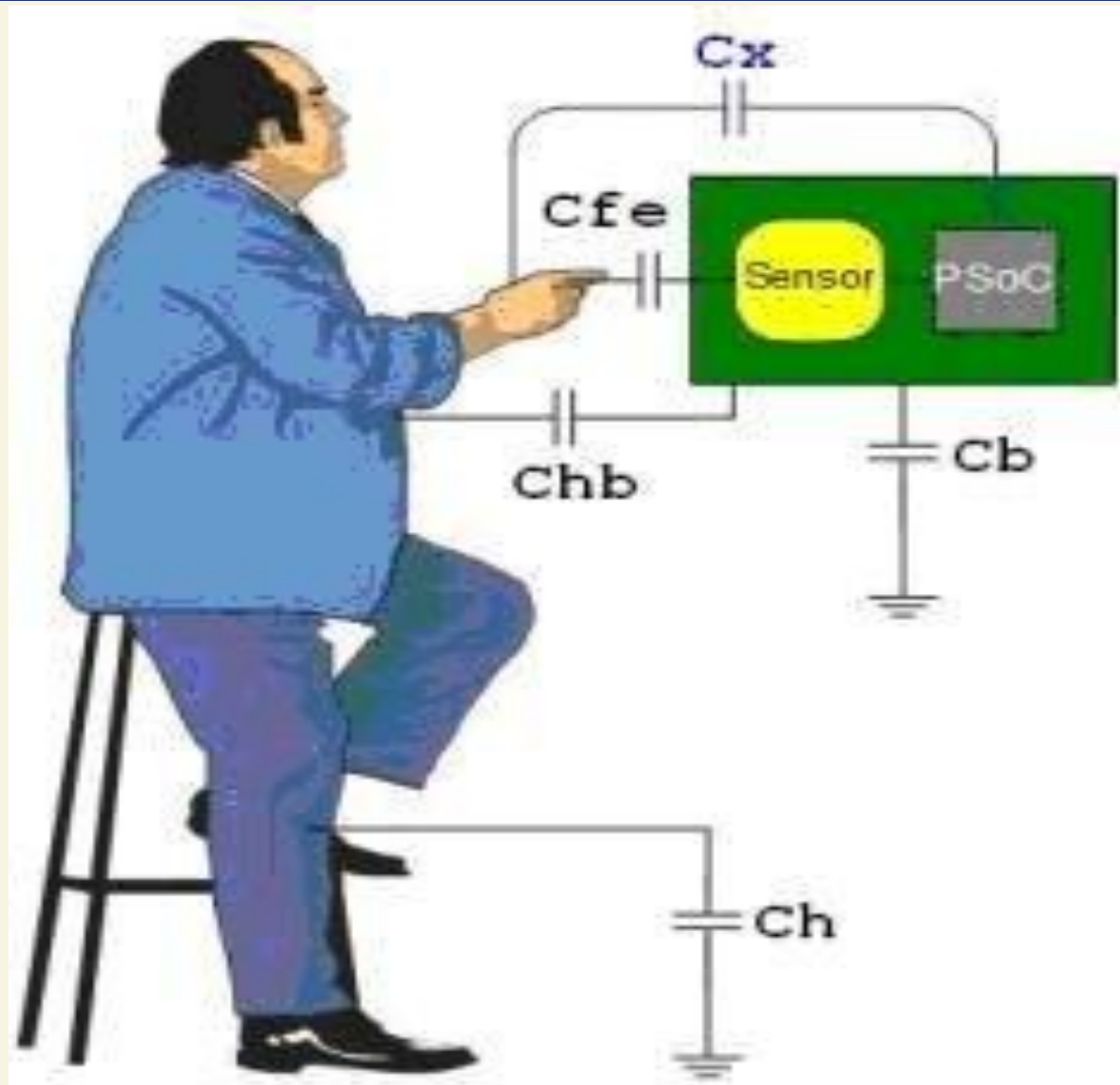

# CapSense

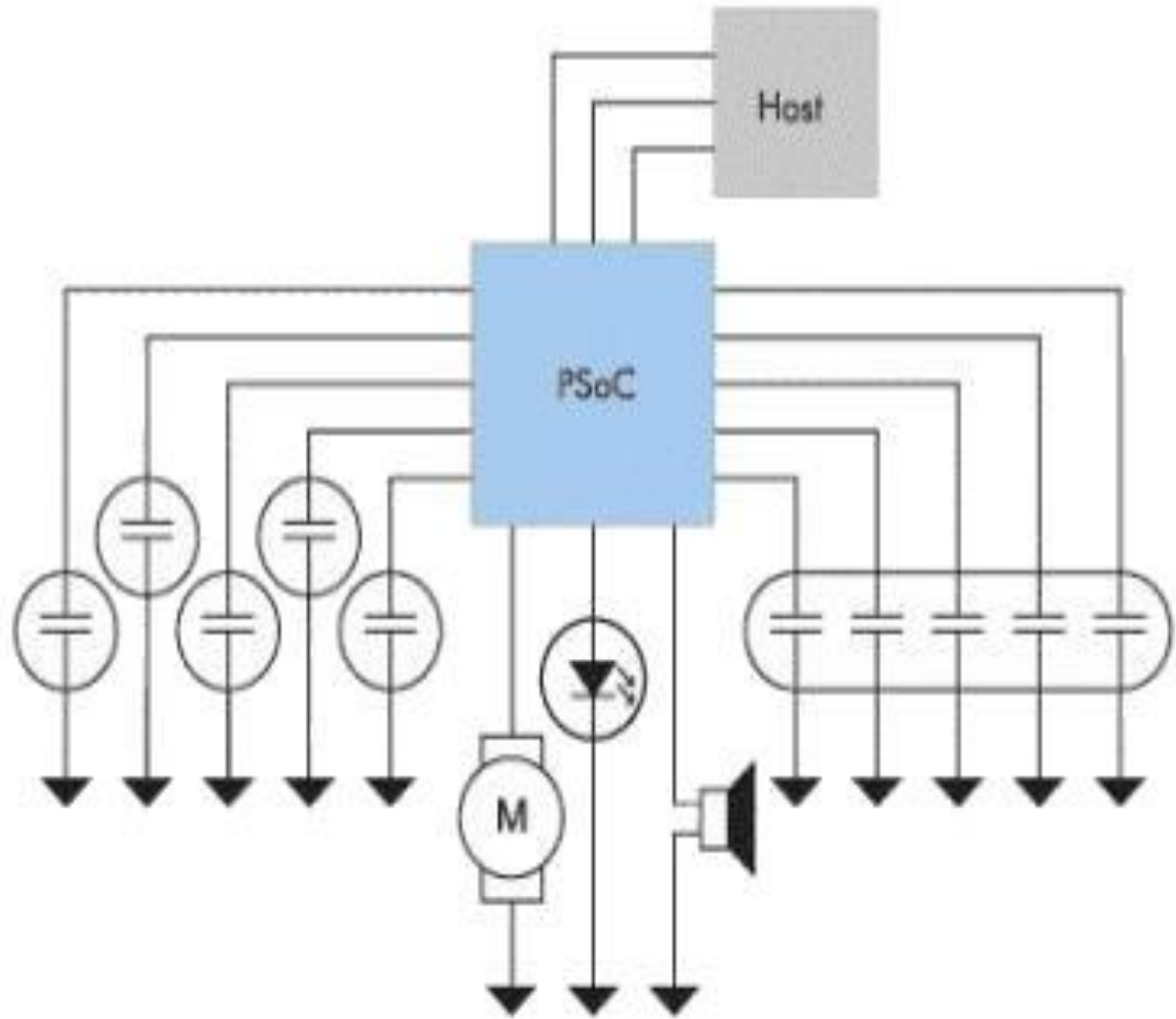



## What is CapSense Touch-Sensing?

**Detect presence / absence of conductive object, e.g. a finger**



Buttons



Sliders



Proximity  
Sensing



Touchpad

- "Multi-Touch"
- Gestures

## What is CapSense Touch-Sensing?

**CapSense works Everywhere:**

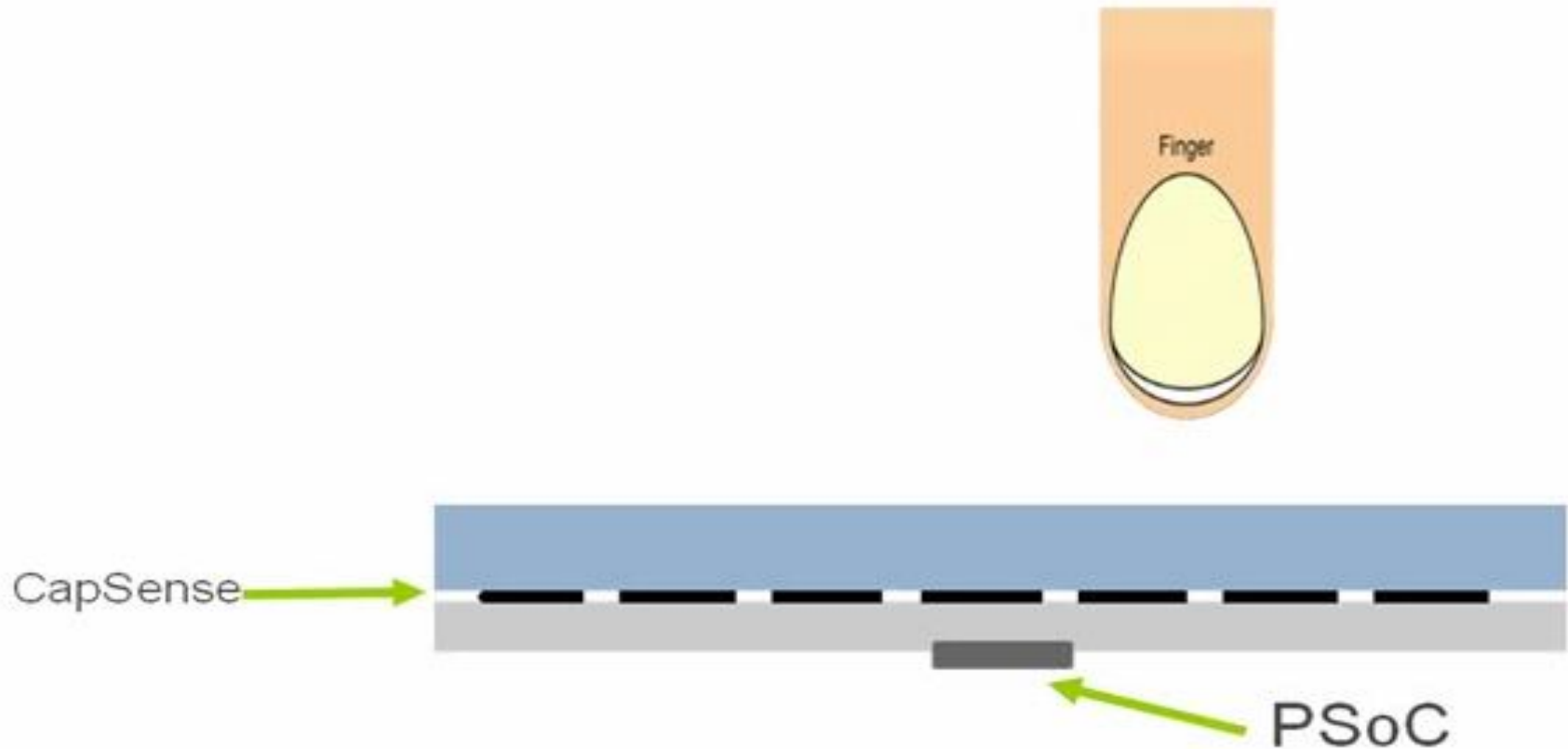

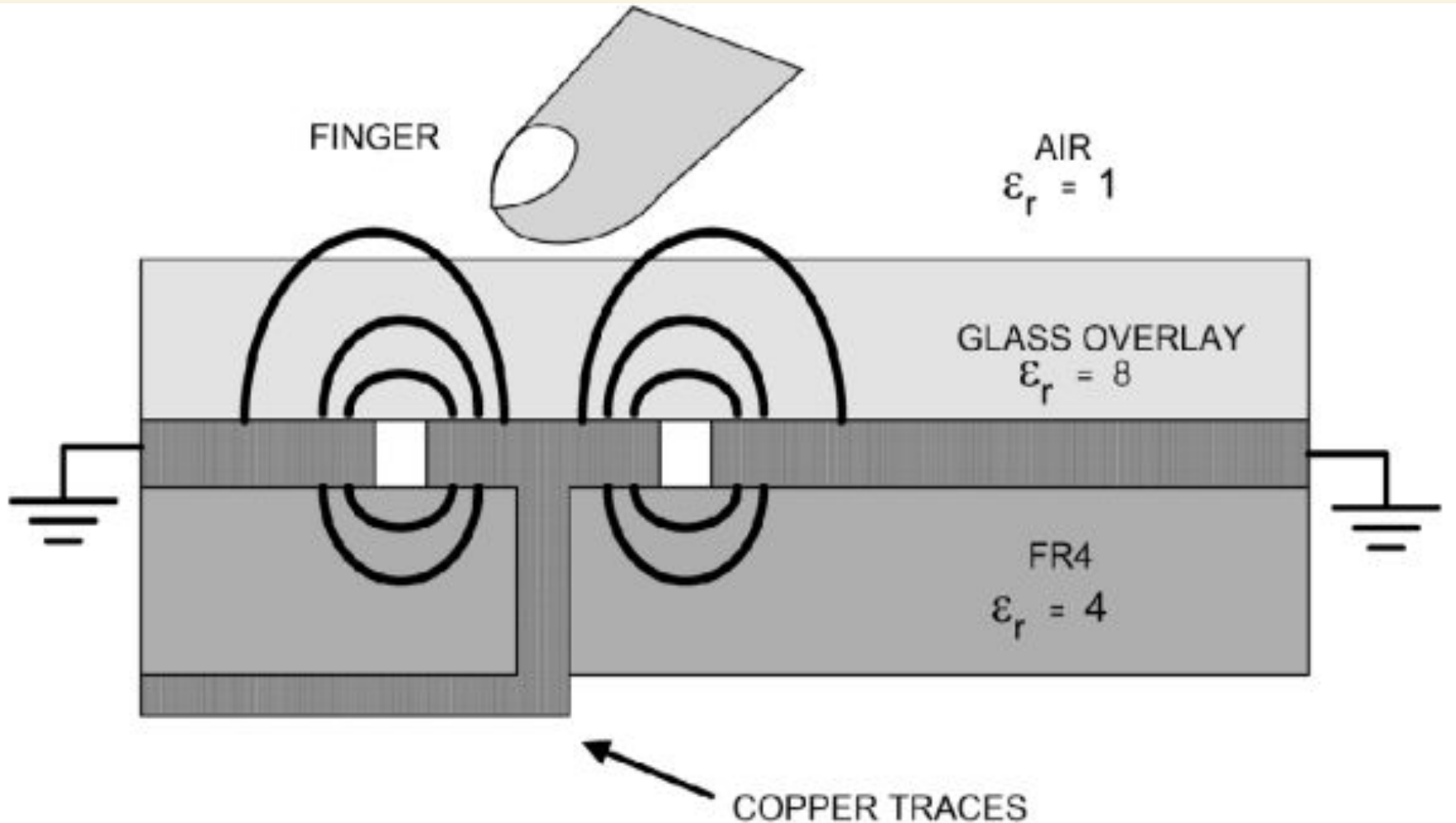

## What is CapSense Touch-Sensing?

### CapSense works Everywhere:



Any surface such as glass or plastic

Overlay

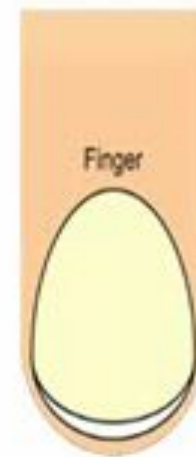

CapSense



PSoC



## What is CapSense Touch-Sensing?

### CapSense works Everywhere:



Any surface such as glass or plastic



Any environment such as rain or with gloves

Gloves

Overlay



CapSense



PSoC

## How CapSense Works?

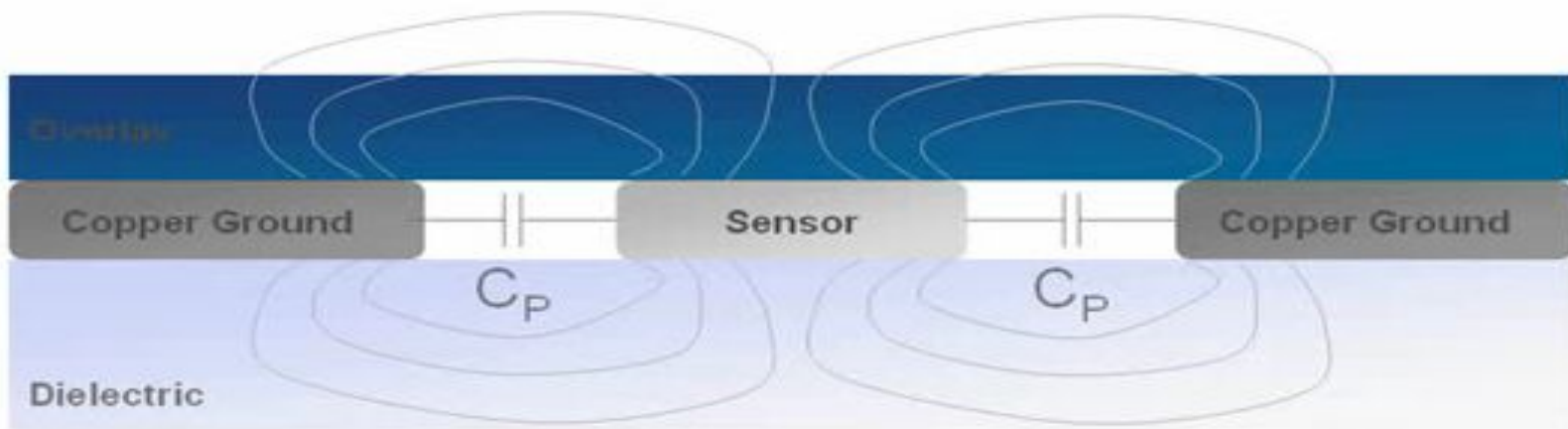

\* Diagram not to scale

## How CapSense Works?

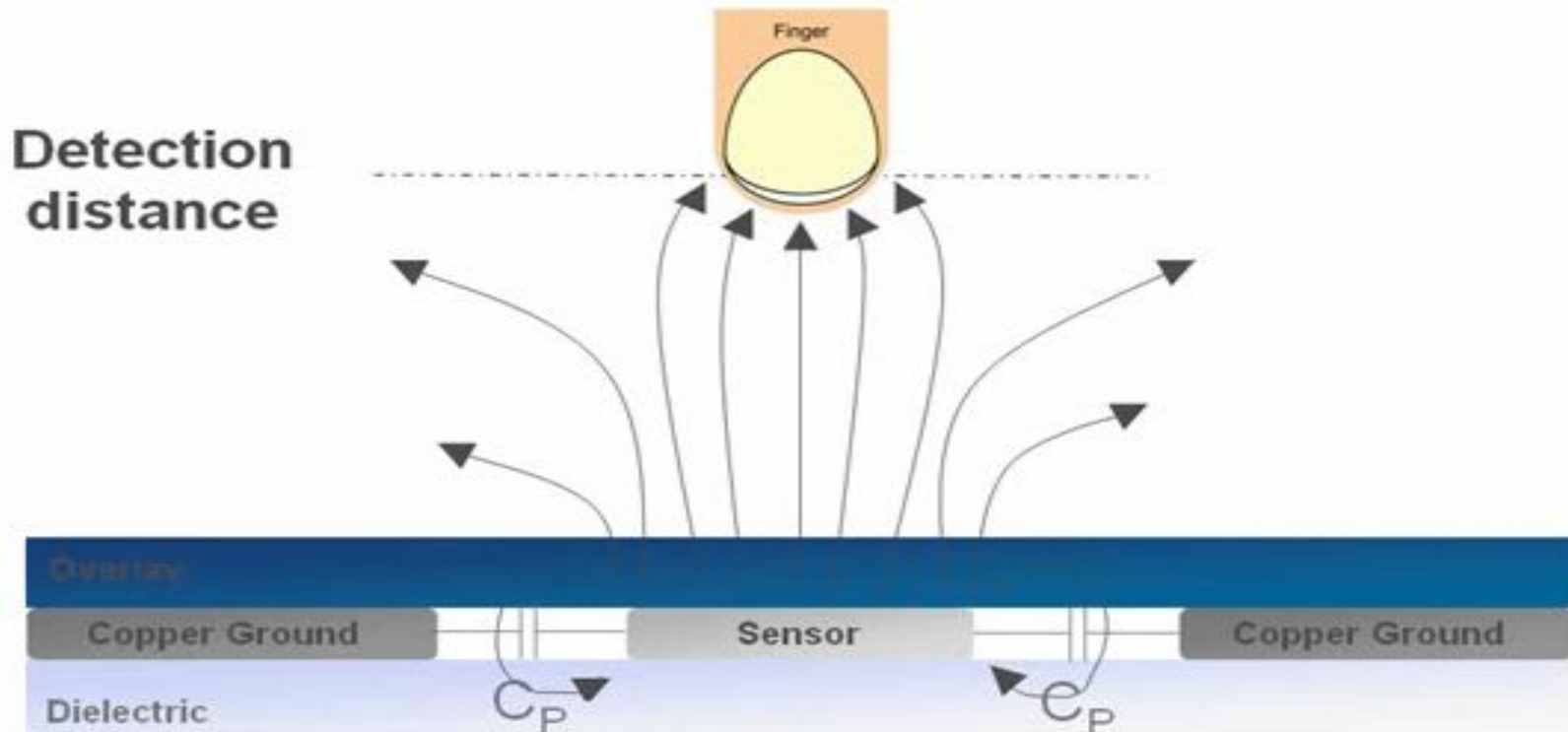

\* Diagram not to scale

## How CapSense Works?

Sensor Capacitance =  $C_X$   
 $C_X = C_P + C_F$

**Detection distance**

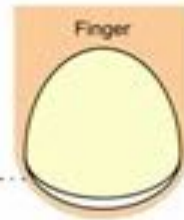

\* Diagram not to scale

## **Overview:**

**Activate and use  
the 2 CapSense buttons and linear slider  
on the DVK board  
and  
output the results  
to the LCD Character screen and Leds.**



## Objective:

1. **For button presses, to indicate which button is on by Leds.**
2. **For the slider, to display the centered position of the finger on the slider is hexadecimal format and horizontal bar.**

Figure 1-1. Simplified Block Diagram

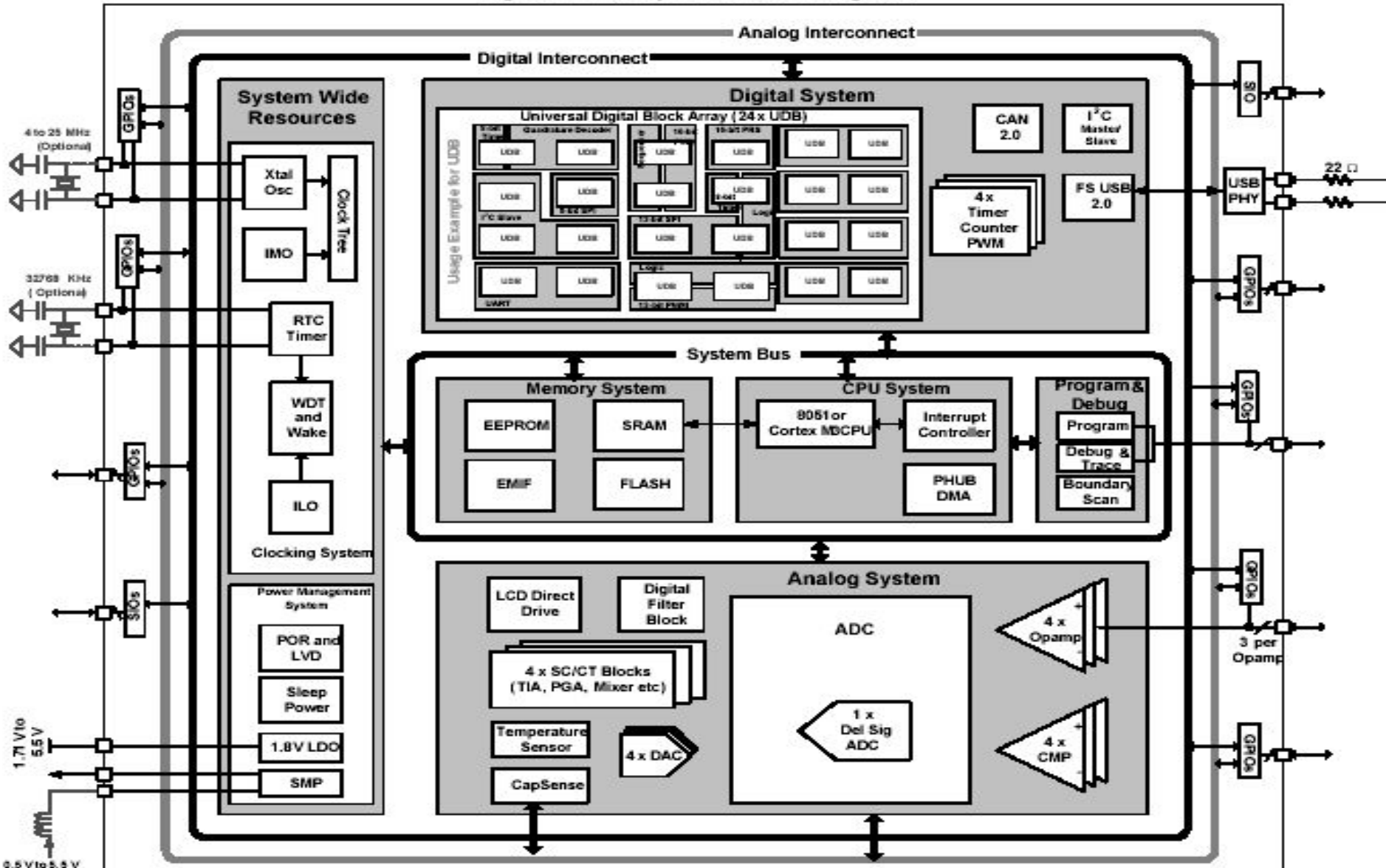

## CapSense in PSoC 3 / PSoC 5

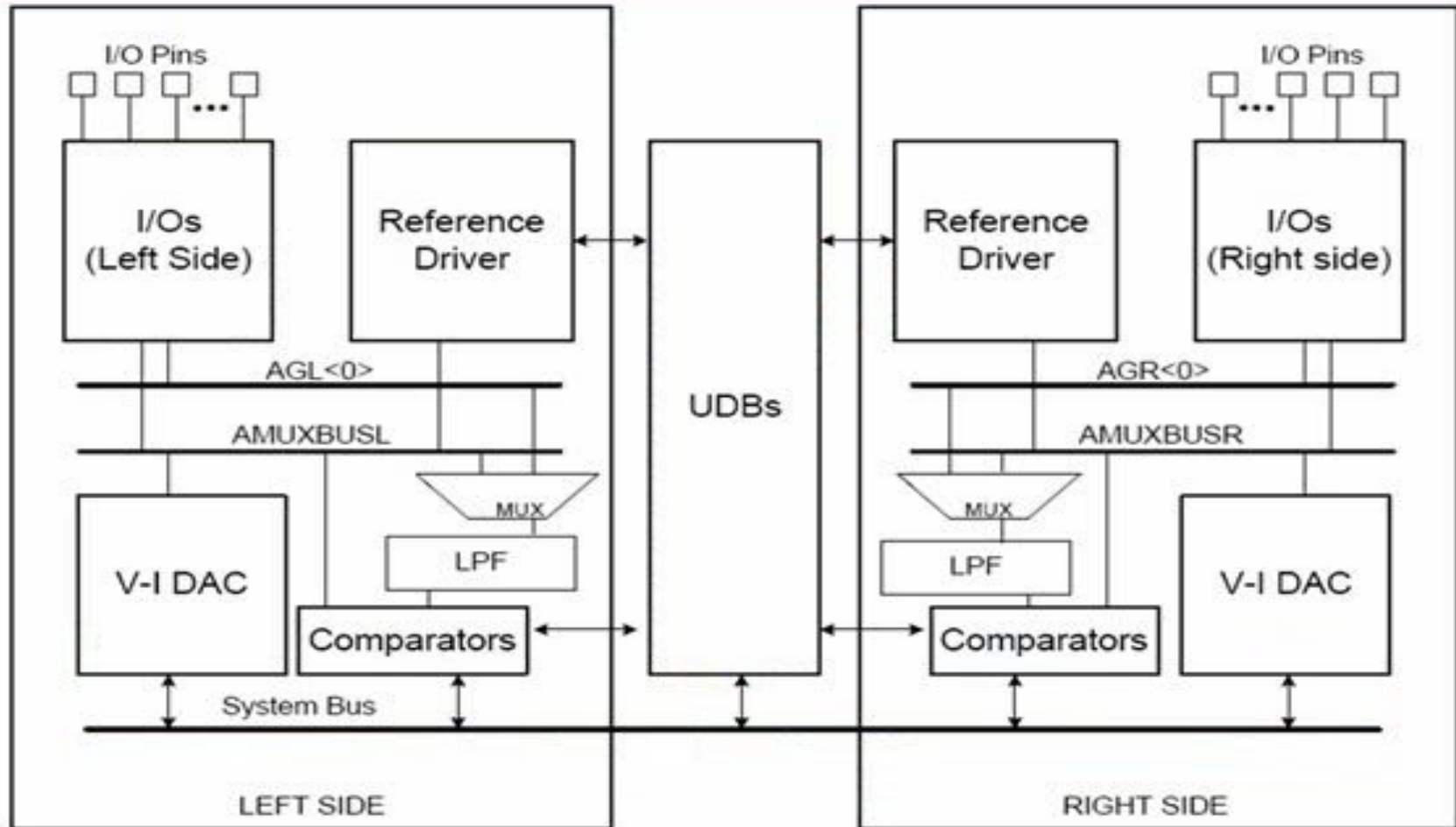

**Follow the below steps to do this:**

- **The Lab already has the LCD Character component installed and configured.**
- **Add a CapSense component from the component catalog.**
- **In the general tab, configure the CapSense component as in the image below**

## CapSense\_CSD\_Design Example Project

The available widgets are:  
- Buttons  
- Liner Slider

CapSense\_CSD

CapSense CSD



Displays CapSense slider  
position:  
Configured for horizontal  
bargraph

LCD

Character LCD



LED1  
LED2



LEDs indicate pressing of  
a CapSense button



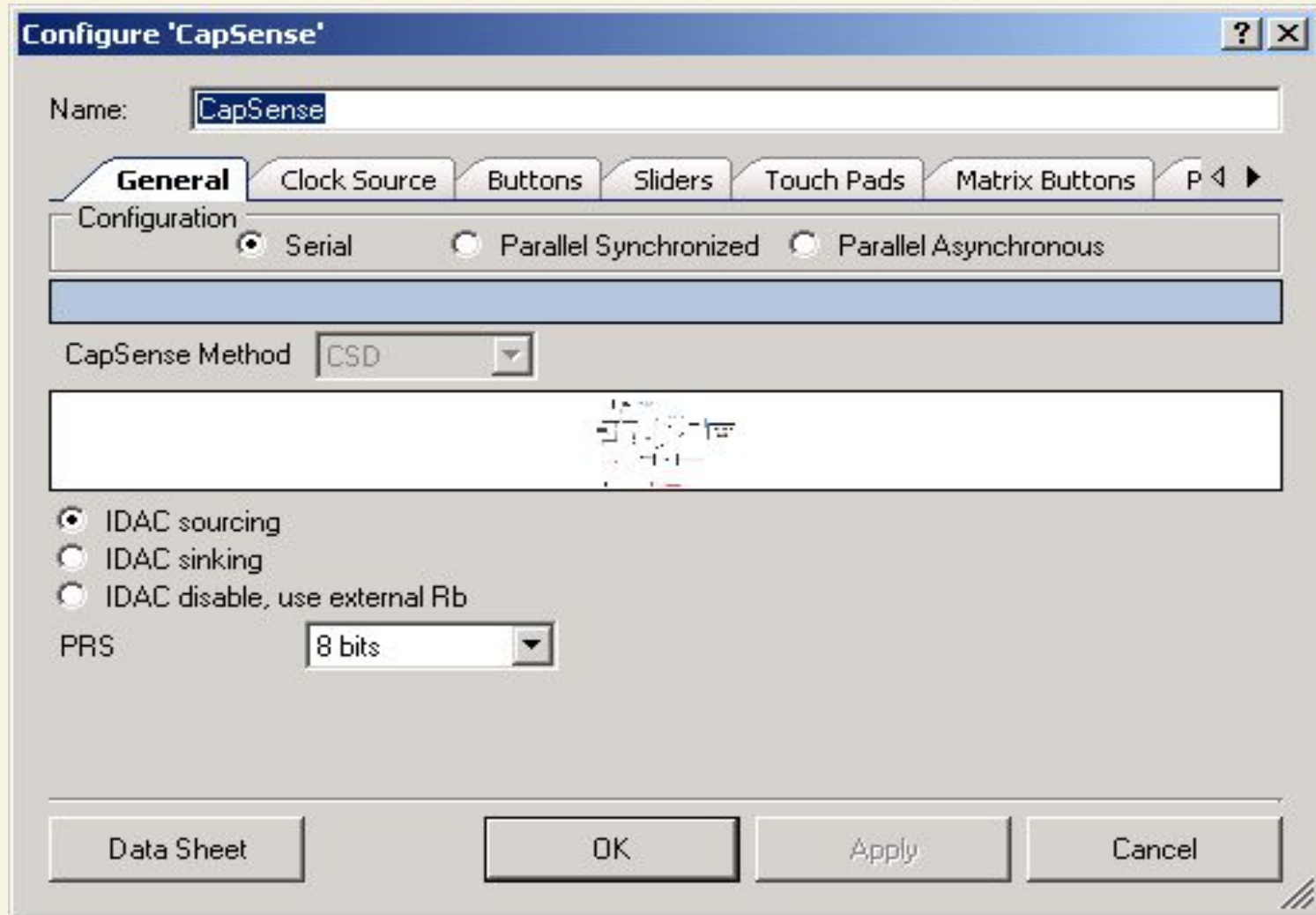

**In the general tab configure the CapSense component**

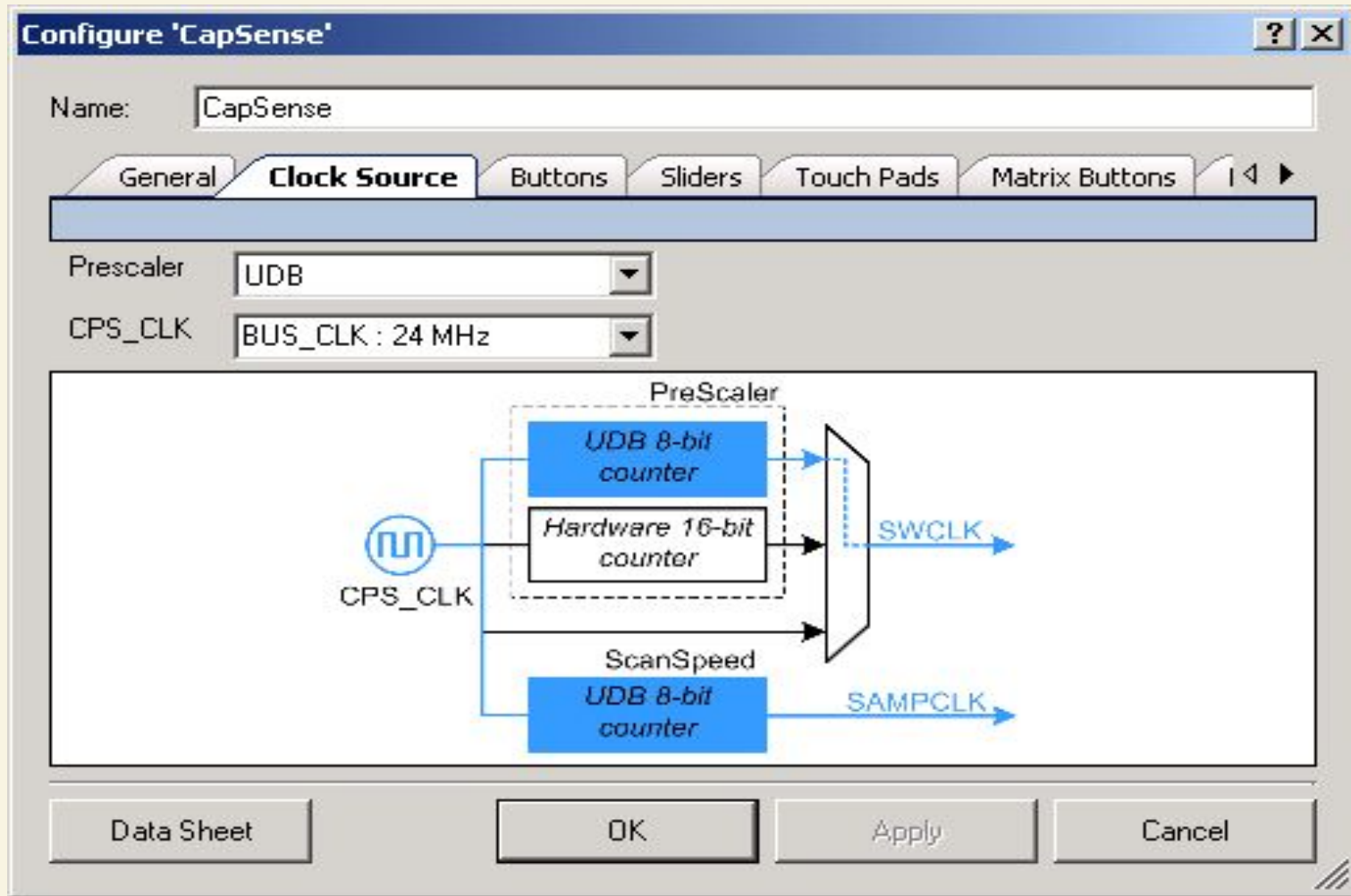

**In the clock source tab, configure the CapSense component**

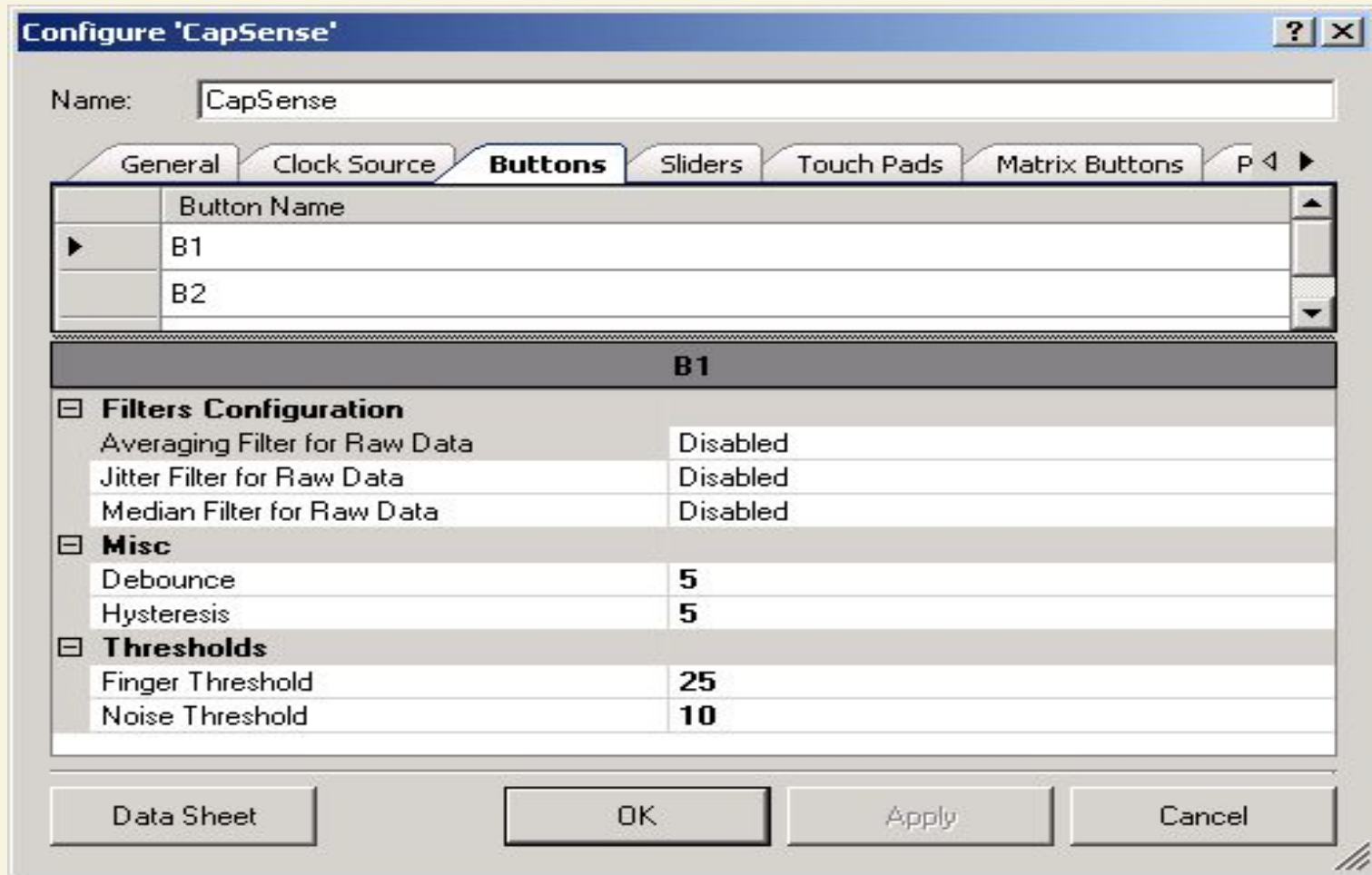

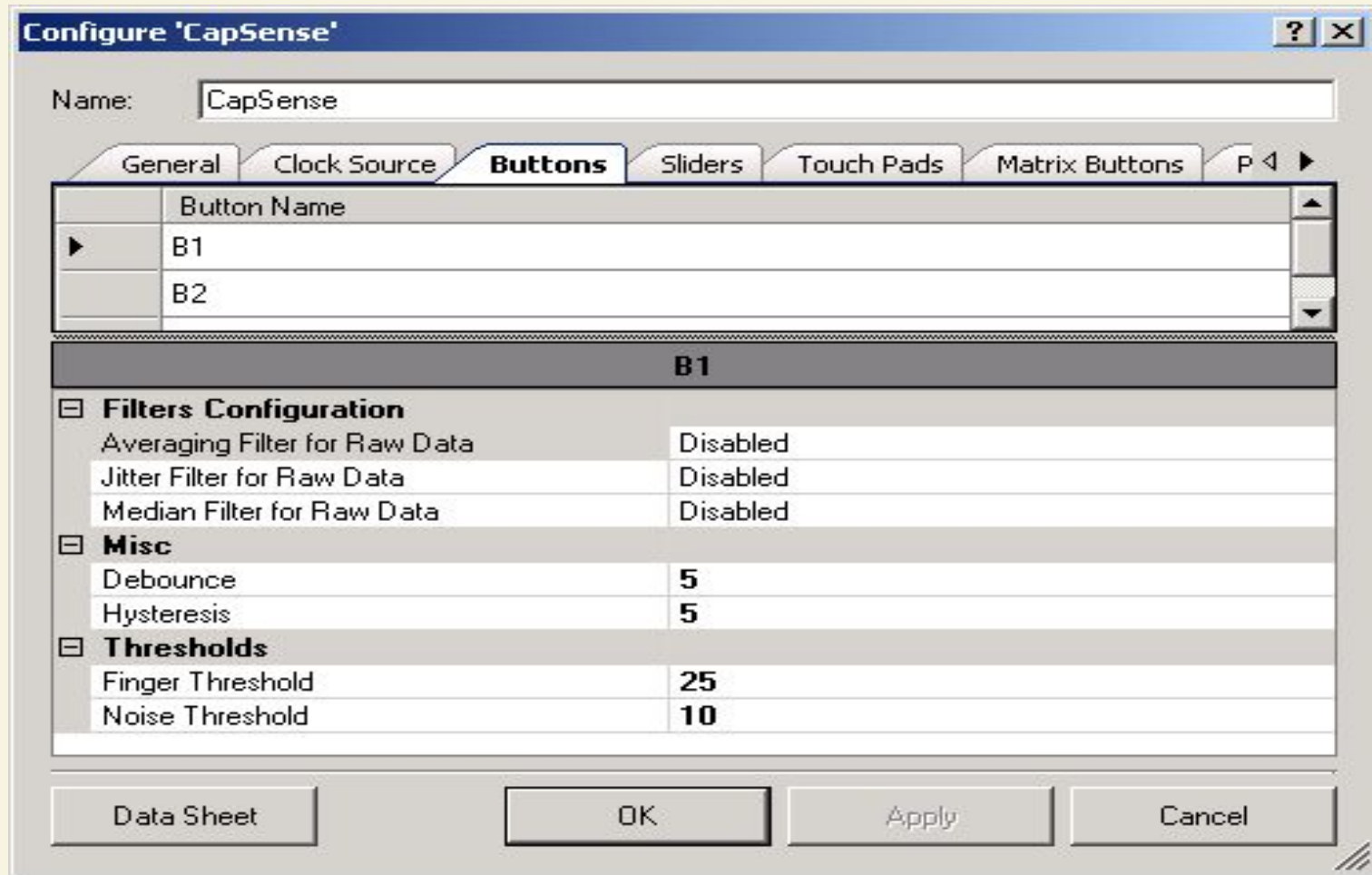

**In the buttons tab, configure the component**

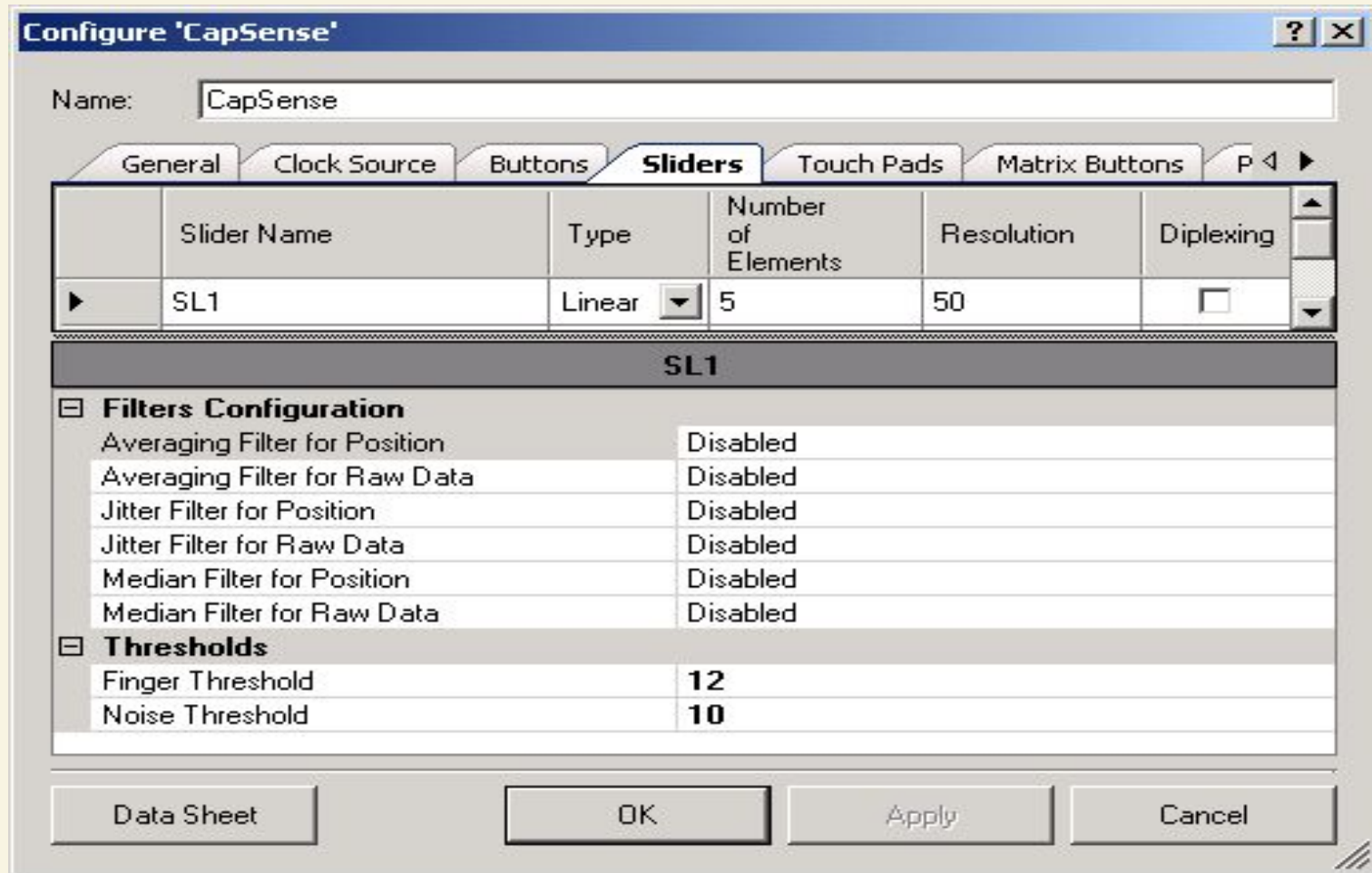

**In the sliders tab configure the component**



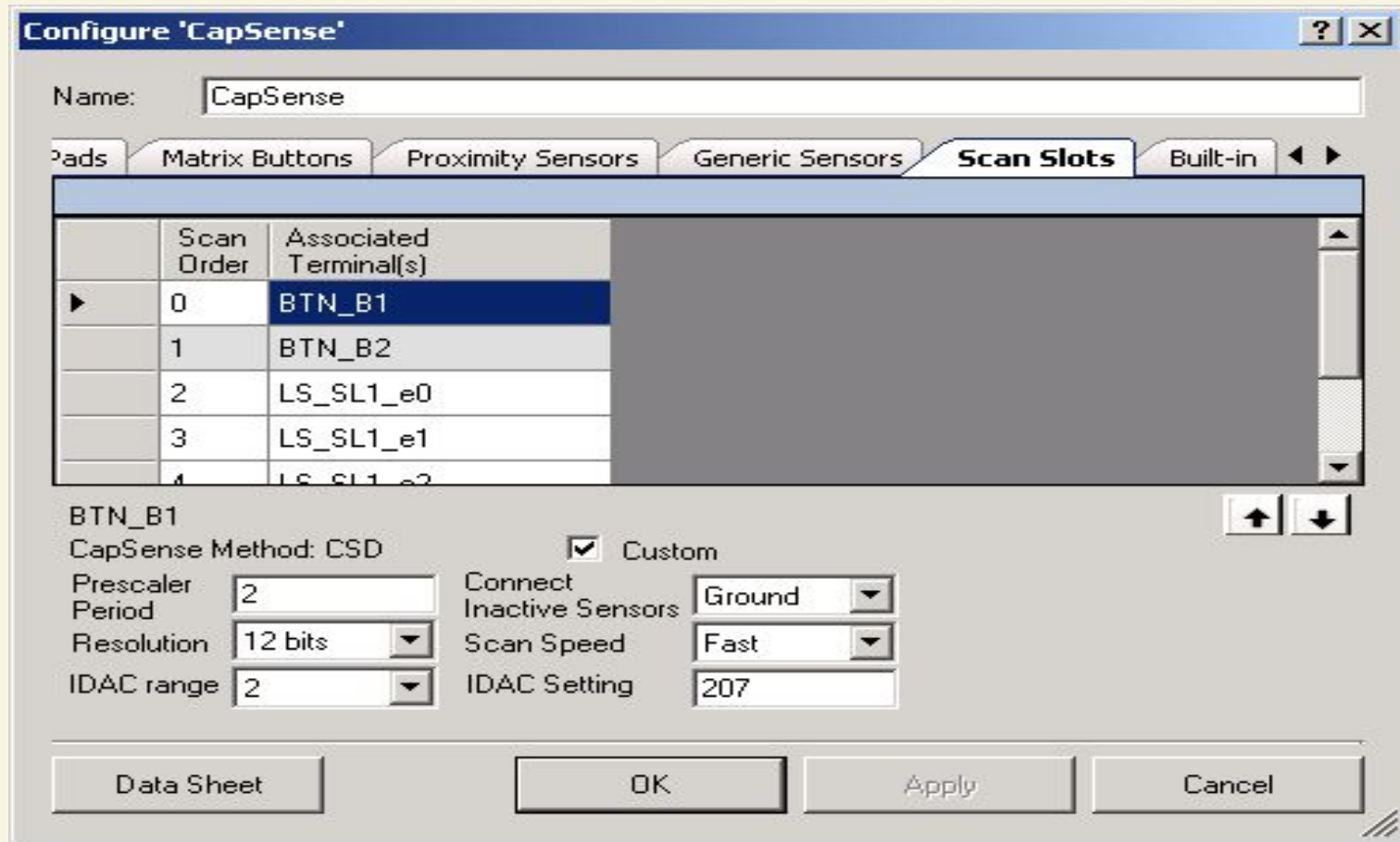

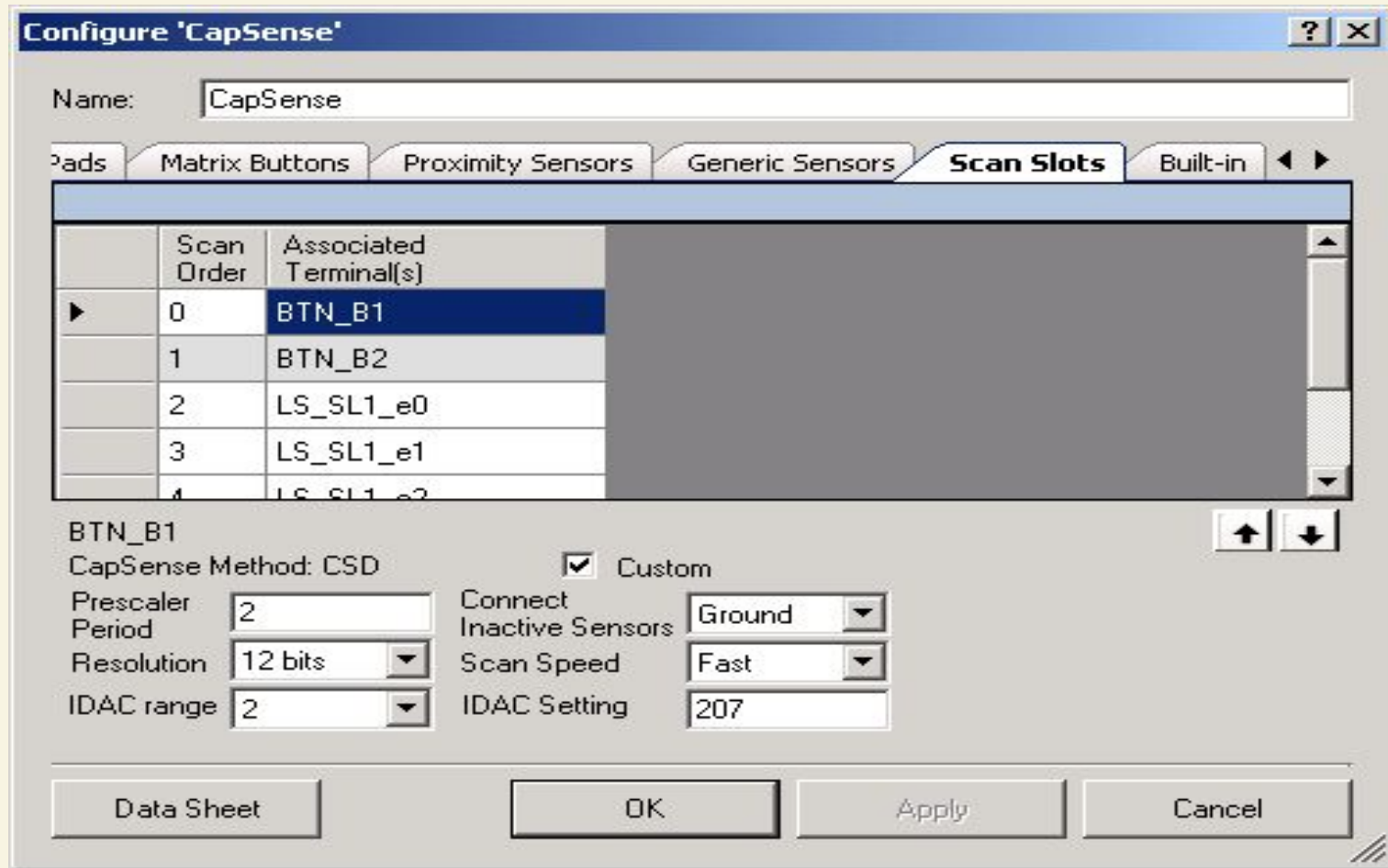

**In the scan slots tab, configure the buttons (BTN\_B1 and BTN\_B2)**

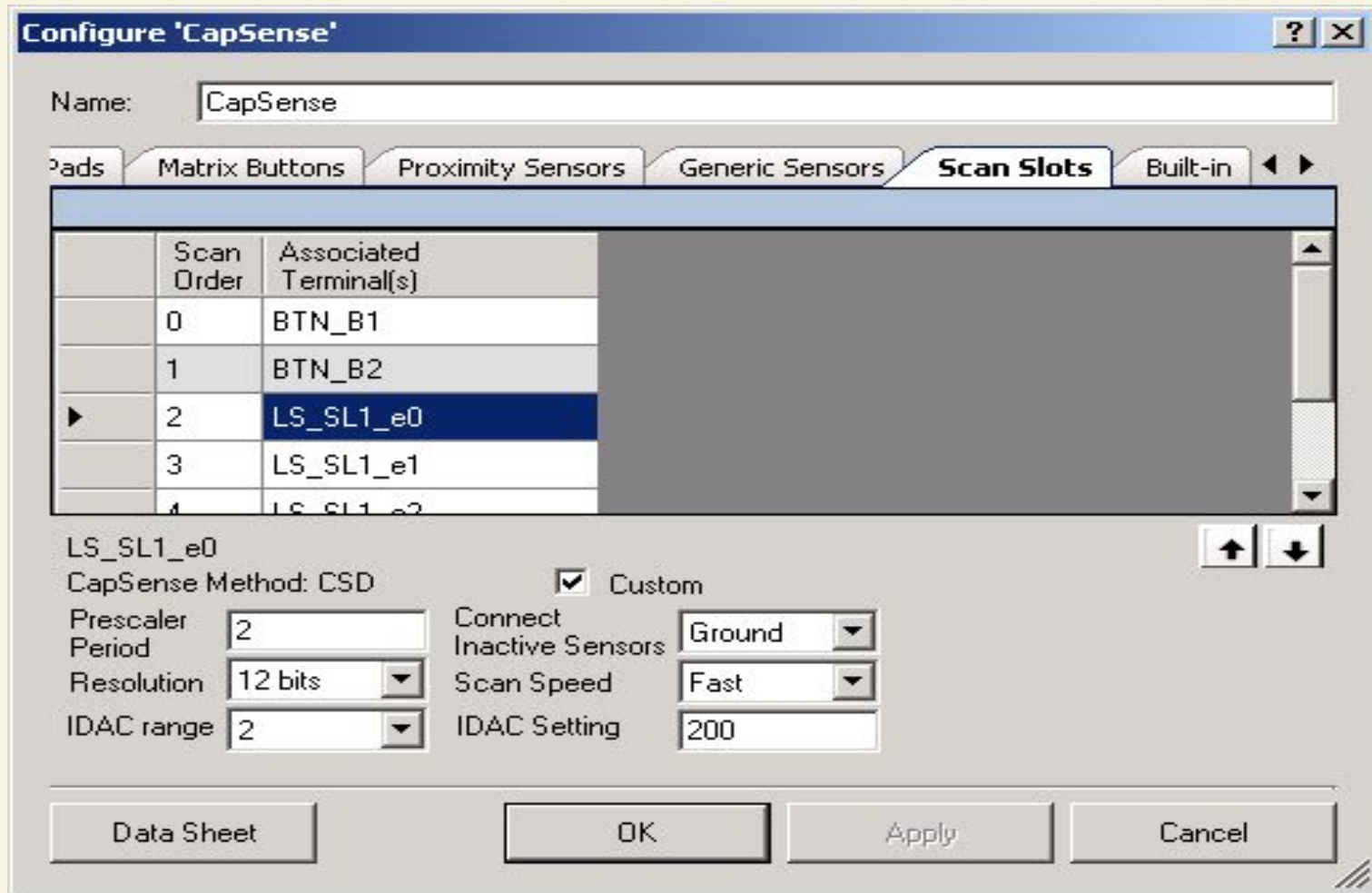

**In the scan slots tab configure the slider elements (LS\_SL1\_e0-to-4)**

Alias	Name	Pin	Lock	Type
sCmod	CapSense_sbCSD_cCmod	P2[7]	<input type="checkbox"/>	Analog
LS_SL1_e4	CapSense_sbCSD_cPort [6]	P0[4]	<input checked="" type="checkbox"/>	Analog
LS_SL1_e3	CapSense_sbCSD_cPort [5]	P0[3]	<input checked="" type="checkbox"/>	Analog
LS_SL1_e2	CapSense_sbCSD_cPort [4]	P0[2]	<input checked="" type="checkbox"/>	Analog
LS_SL1_e1	CapSense_sbCSD_cPort [3]	P0[1]	<input checked="" type="checkbox"/>	Analog
LS_SL1_e0	CapSense_sbCSD_cPort [2]	P0[0]	<input checked="" type="checkbox"/>	Analog
BTN_B2	CapSense_sbCSD_cPort [1]	P0[6]	<input checked="" type="checkbox"/>	Analog
BTN_B1	CapSense_sbCSD_cPort [0]	P0[5]	<input checked="" type="checkbox"/>	Analog
	LCD_LCDPort [6:0]	P2[6:0]	<input checked="" type="checkbox"/>	Digital Output

**Configure the pins tab in the .cydwr file**



PSoC Creator 2.1

File Edit View Debug Project Build Tools Window Help

Workspace Explorer

Source Components Datasheets Results

**Start Page**

PSoC® Creator™



简体中文 日本語 한국어 English

**PSoC Creator News and Information**

[Happy Lunar New Year!](#)  
Posted on 02/11/2013

Gong Xi Fa Cai! As many of my friends and colleagues are celebrating the New Year and welcoming in the year of the water snake, I wanted to take a minute and wish you all well. May the New Year bring each of you prosperity, good luck and a new PSoC design. ....  
[Read More](#)

[Tips + Tricks: Menu Customization](#)  
Posted on 01/24/2013

Did you know you can create a customized menu in PSoC® Creator? Right click in a blank area of the top menu and select customize from the

**Recent Projects**

- HelloWorld\_Blinky01.cywrk
- CapSense\_CSD\_Design01...
- CapSense\_CSD\_Design01...
- CharLCD\_CustomFont01.c...
- CharLCD\_CustomFont01.c...

Create New Project...  
Open Existing Project...

**Getting Started**

- PSoC Creator Start Page
- Quick Start Guide
- Intro to PSoC
- Intro to PSoC Creator
- PSoC Creator Training
- Help Tutorials
- Getting Started With PSoC 3
- Getting Started With PSoC 5

**Examples and Kits**

- Find Example Project...
- No Kit Packages Installed

**Notice List**

0 Errors 0 Warnings

De...	File	Error L

**Output**

Show output from: All

Log file for this session is located at: C:\Documents and Settings\Admin.MICROSOFT-7D0472\Local Se

# File – New - Projekt

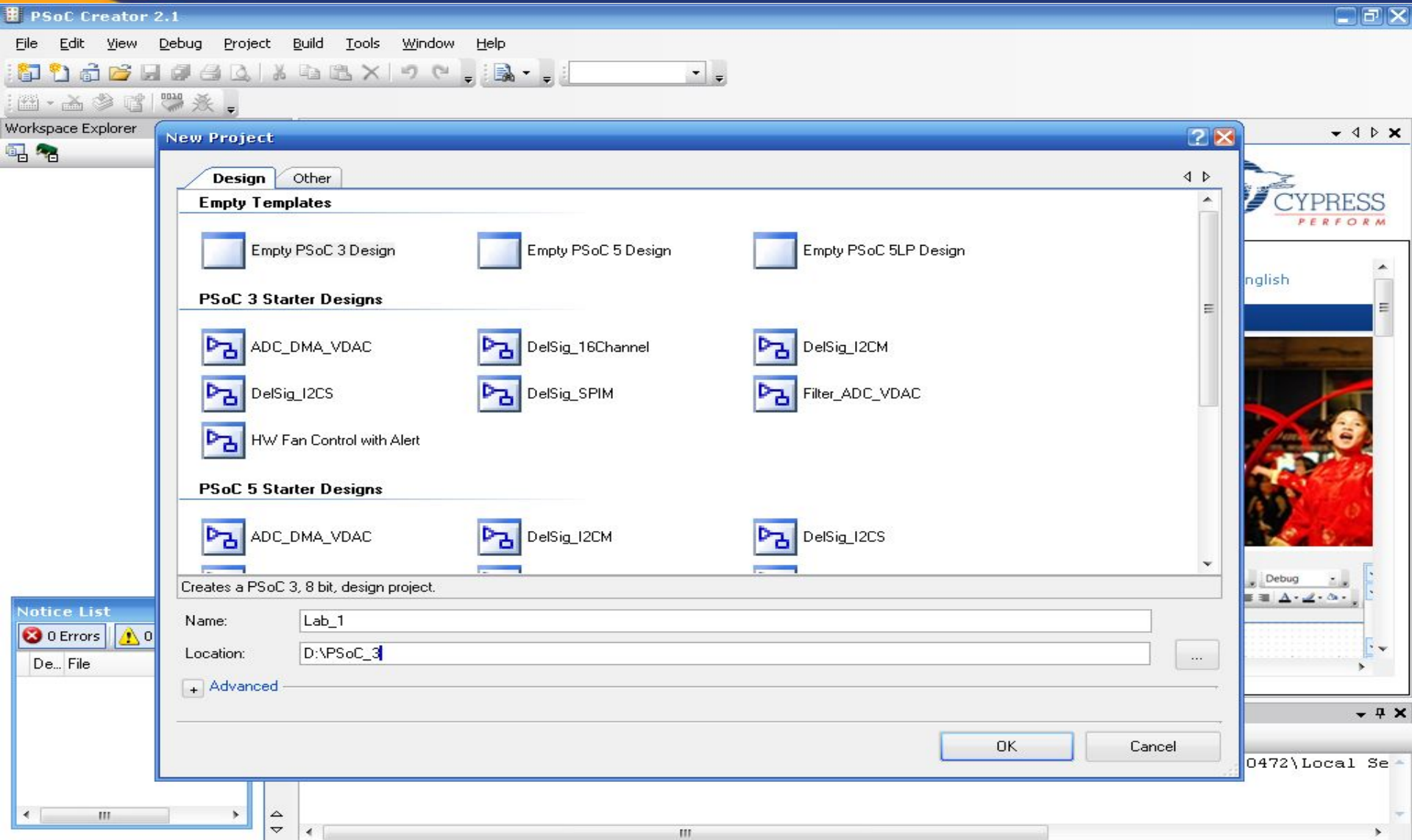

The screenshot displays the PSoC Creator 2.1 application window. The main menu bar includes File, Edit, View, Debug, Project, Build, Tools, Window, and Help. The toolbar contains various icons for file operations and project management. The 'New Project' dialog box is open, showing the 'Design' tab. It lists several project templates under three categories: 'Empty Templates', 'PSoC 3 Starter Designs', and 'PSoC 5 Starter Designs'. The 'Name' field is set to 'Lab\_1' and the 'Location' field is set to 'D:\PSoC\_3'. The 'Advanced' options are expanded. The 'Notice List' panel on the left shows '0 Errors' and '0 Warnings'. The status bar at the bottom indicates 'Ready' and '0 Errors 0 Warnings 0 Notes'.

**PSoc Creator 2.1**

File Edit View Debug Project Build Tools Window Help

Workspace Explorer

**New Project**

Design Other

**Empty Templates**

- Empty PSoC 3 Design
- Empty PSoC 5 Design
- Empty PSoC 5LP Design

**PSoC 3 Starter Designs**

- ADC\_DMA\_VDAC
- DelSig\_16Channel
- DelSig\_I2CM
- DelSig\_I2CS
- DelSig\_SPIM
- Filter\_ADC\_VDAC
- HW Fan Control with Alert

**PSoC 5 Starter Designs**

- ADC\_DMA\_VDAC
- DelSig\_I2CM
- DelSig\_I2CS

Creates a PSoC 3, 8 bit, design project.

Name: Lab\_1

Location: D:\PSoC\_3

+ Advanced

OK Cancel

Notice List

0 Errors 0 Warnings

De... File

Ready

0 Errors 0 Warnings 0 Notes

EN 19:02



# Empty PSoC 3 Design

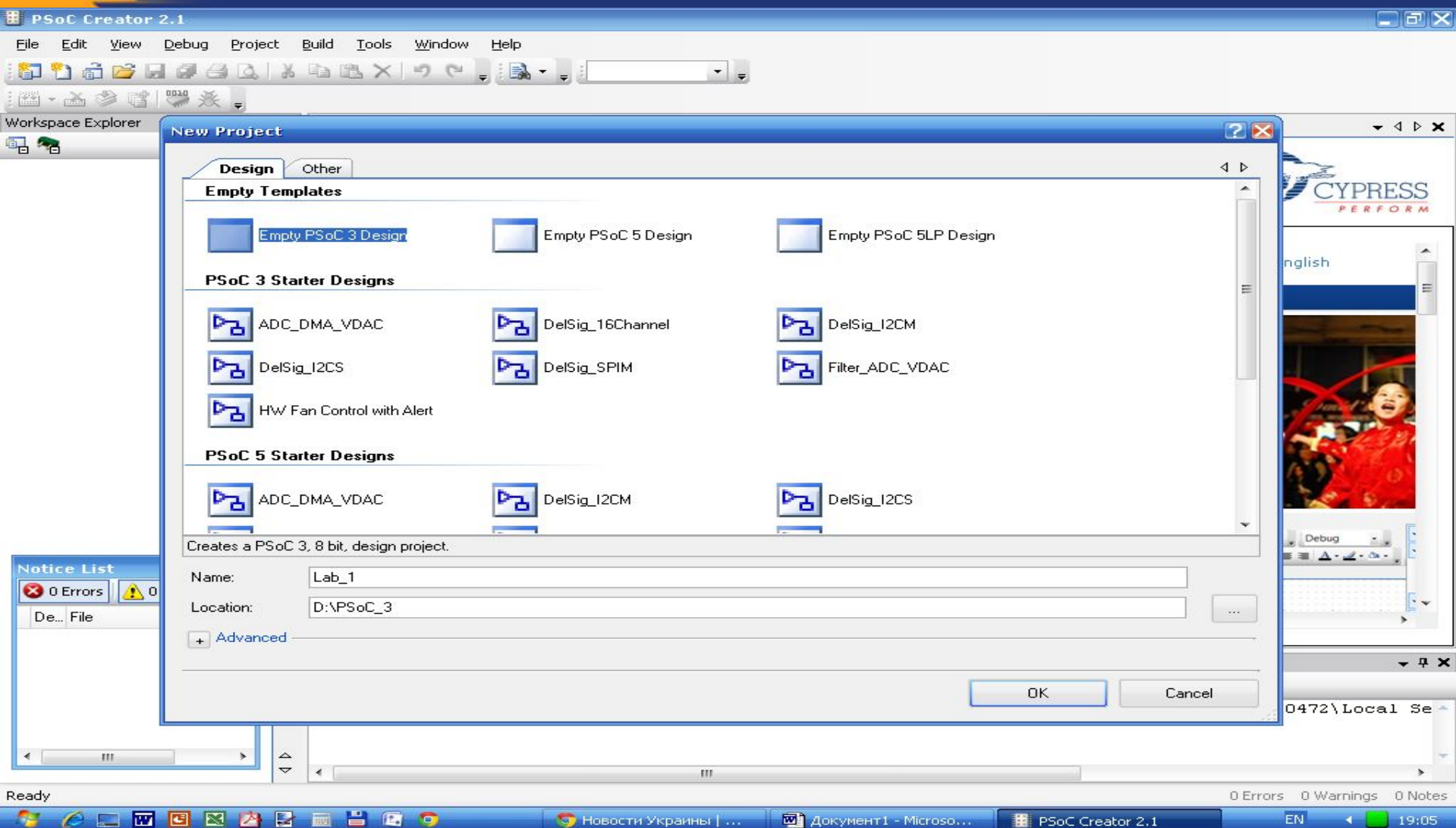

The screenshot displays the PSoC Creator 2.1 interface. The main window is titled "New Project" and is divided into "Design" and "Other" tabs. Under the "Design" tab, there are three sections: "Empty Templates", "PSoC 3 Starter Designs", and "PSoC 5 Starter Designs". The "Empty Templates" section has three options: "Empty PSoC 3 Design" (which is selected), "Empty PSoC 5 Design", and "Empty PSoC 5LP Design". The "PSoC 3 Starter Designs" section includes "ADC\_DMA\_VDAC", "DelSig\_I2CS", "HW Fan Control with Alert", "DelSig\_16Channel", "DelSig\_SPIM", and "Filter\_ADC\_VDAC". The "PSoC 5 Starter Designs" section includes "ADC\_DMA\_VDAC", "DelSig\_I2CM", and "DelSig\_I2CS". Below these sections, a description reads "Creates a PSoC 3, 8 bit, design project." The "Name:" field contains "Lab\_1" and the "Location:" field contains "D:\PSoC\_3". There is an "Advanced" button with a plus sign. At the bottom right of the dialog are "OK" and "Cancel" buttons. In the background, the "Notice List" shows "0 Errors" and "0 Warnings". The Windows taskbar at the bottom shows the system tray with "0 Errors 0 Warnings 0 Notes" and the time "19:05".

# Configure LCD

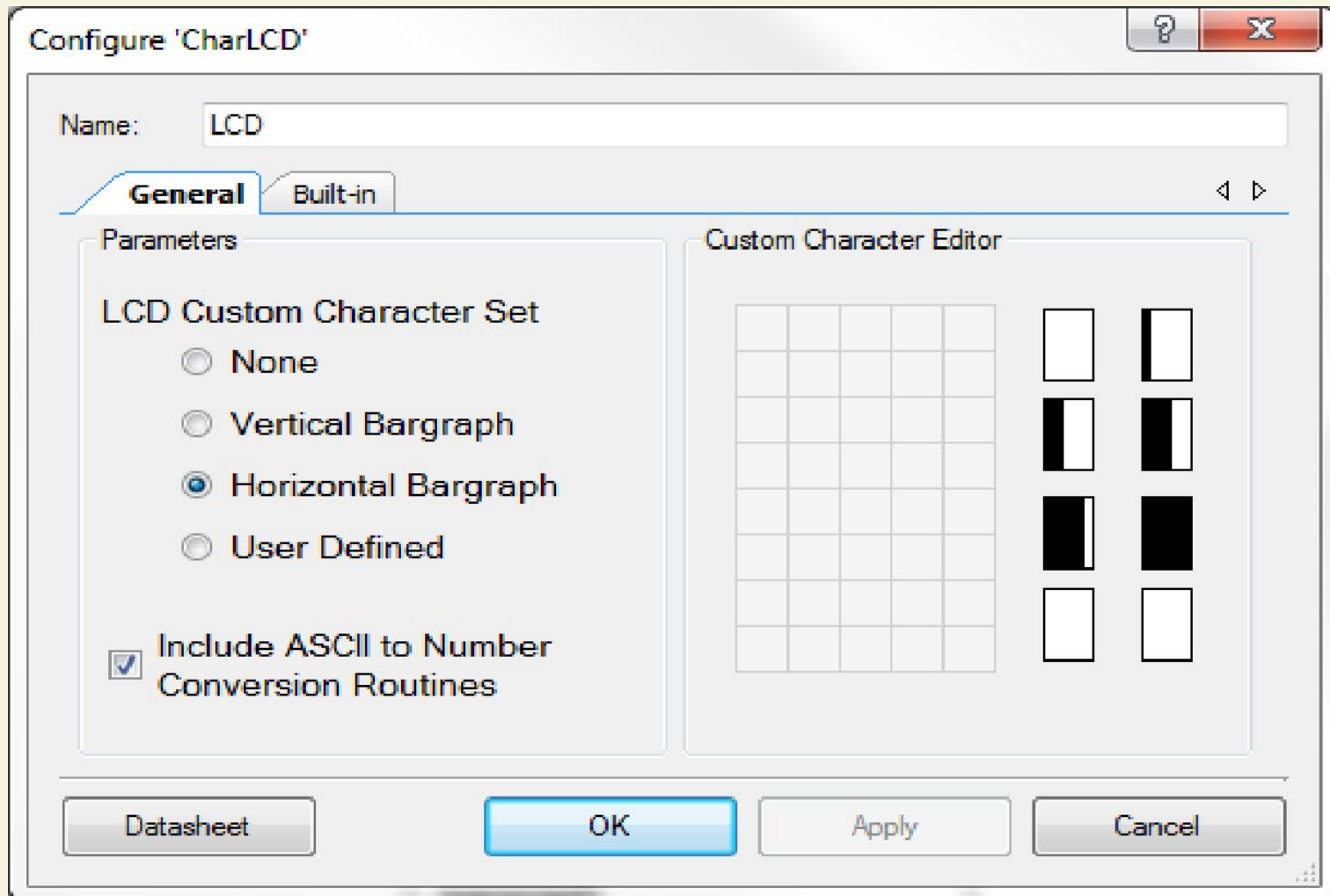

# Configure CSD

## Configure 'CapSense\_CSD'



Name: CapSense\_CSD

**General**

Widgets Config

Scan Order

Advanced

Tune Helper

Built-in



 Load Settings  Save Settings

Tuning method

Number of channels

Raw Data Noise Filter

Water proofing and detection

Clock Settings

Enable clock input

Scan Clock

Datasheet

OK

Apply

Cancel

# Configure CSD

Configure 'CapSense\_CSD'

Name: CapSense\_CSD

General **Widgets Config** Scan Order Advanced Tune Helper Built-in

+ Add Button -x Remove Rename

- Buttons
  - Button0
  - Button1
- Linear Sliders
  - LinearSlider0
- Radial Sliders
- Matrix Buttons
- Touchpads
- Proximity Sensors
- Generics

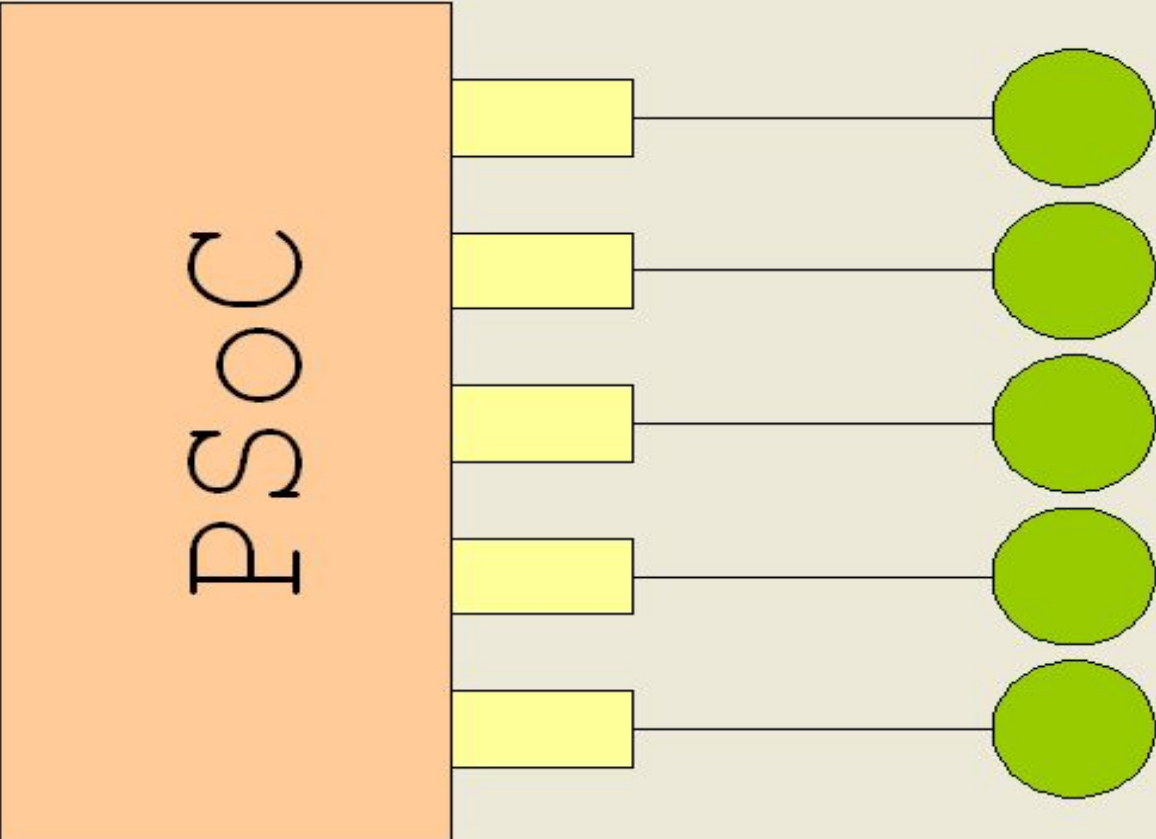

PSOC

Datasheet OK Apply Cancel

# Configure CSD

**Configure 'CapSense\_CSD'** ? X

Name:

◀ ▶

Scan Slot	Ch0 Sensor
0	Button0__BTN
1	Button1__BTN
2	LinearSlider0_e0__LS
3	LinearSlider0_e1__LS
4	LinearSlider0_e2__LS
5	LinearSlider0_e3__LS
6	LinearSlider0_e4__LS

Sensor scan time: Total Scan Time: 5.059 mS



# Configure CSD

**Configure 'CapSense\_CSD'** [?] [X]

Name:

General | Widgets Config | Scan Order | **Advanced** | Tune Helper | Built-in

---

Analog Switch Drive Source:  ▼

Multiple Analog Switch Divider:  ▼

Analog Switch Divider:

---

Scan Speed:  ▼

PRS EMI Reduction:  ▼

---

Sensor Auto Reset:  ▼

Widget Resolution:  ▼

Negative Noise Threshold:

Low Baseline Reset:

---

Shield:  ▼

Inactive Sensor Connection:  ▼

Guard Sensor:  ▼

Current Source:  ▼

IDAC range:  ▼

Number of Bleed Resistors:  ▼

Number of Bleed Resistors, channel 1:  ▼

---

Digital Resource Implementation:  ▼

Digital Resource Implementation, channel 1:  ▼

---

Voltage reference source

Vref 1.024V (default)

Vdac  1.024 V

---





# Configure CSD

For CY8CKIT-030 and CY8CKIT-050: Reassign the CapSense LinearSlider and Buttons in the 'Pins' tab of the Design-wide Resources file to port 5. To be precise, reassign the 5 Slider segments to P5[4:0], Button0 to P5[5], and Button1 to P5[6]. Also ensure that the Cmod capacitor is assigned to P6[4] in the pins tab of the Design Wide Resources (.cydwr) file in PSoC Creator.

Alias	Name	Port	Pin	Loc
Cmod_CH0	\CapSense_CSD:CmodCH0\	P6[4]	6	<input checked="" type="checkbox"/>
Button0__BTN	\CapSense_CSD:PortCH0[0]\	P5[5]	32	<input checked="" type="checkbox"/>
Button1__BTN	\CapSense_CSD:PortCH0[1]\	P5[6]	33	<input checked="" type="checkbox"/>
LinearSlider0_e0__LS	\CapSense_CSD:PortCH0[2]\	P5[0]	16	<input checked="" type="checkbox"/>
LinearSlider0_e1__LS	\CapSense_CSD:PortCH0[3]\	P5[1]	17	<input checked="" type="checkbox"/>
LinearSlider0_e2__LS	\CapSense_CSD:PortCH0[4]\	P5[2]	18	<input checked="" type="checkbox"/>
LinearSlider0_e3__LS	\CapSense_CSD:PortCH0[5]\	P5[3]	19	<input checked="" type="checkbox"/>
LinearSlider0_e4__LS	\CapSense_CSD:PortCH0[6]\	P5[4]	31	<input checked="" type="checkbox"/>
	\LCD:LCDPort[6:0]\	P2[6:0]	95..99,1..2	<input checked="" type="checkbox"/>
	LED1	P12[6]	29	<input checked="" type="checkbox"/>
	LED2	P12[7]	30	<input checked="" type="checkbox"/>

LED2\_0 - Digital

```
1  /* *****  
2  * File Name: main.c  
3  *  
4  * Version: 1.00  
5  *  
6  * Description:  
7  * The project explains the usage of CapSense CSD component. The 2 buttons and  
8  * linear sliders are used as sensing elements. LED displays buttons active  
9  * state and slider position is shown on LCD.  
10 *  
11 *****  
12 * Copyright 2012, Cypress Semiconductor Corporation. All rights reserved.  
13 * This software is owned by Cypress Semiconductor Corporation and is protected  
14 * by and subject to worldwide patent and copyright laws and treaties.  
15 * Therefore, you may use this software only as provided in the license agreement  
16 * accompanying the software package from which you obtained this software.  
17 * CYPRESS AND ITS SUPPLIERS MAKE NO WARRANTY OF ANY KIND, EXPRESS OR IMPLIED,  
18 * WITH REGARD TO THIS SOFTWARE, INCLUDING, BUT NOT LIMITED TO, NONINFRINGEMENT,  
19 * IMPLIED WARRANTIES OF MERCHANTABILITY AND FITNESS FOR A PARTICULAR PURPOSE.  
20 ******/  
21  
22 #include <device.h>  
23  
24 /* Needed for Bargraph */  
25 extern uint8 const CYCODE LCD_customFonts[];  
26
```

```
26
27 uint16 curPos, oldPos;
28
29 /*****
30 * Function Name: main
31 *****/
32 * Summary:
33 * Main function performs following functions:
34 * 1. Enable global interrupts.
35 * 2. Initialize CapSense CSD and Start the sensor scanning loop.
36 * 3. Process scanning results and display it on LCD/LED.
37 * Parameters:
38 * None
39 * Return:
40 * None
41 *****/
42 void main()
43 {
44     LCD_Start();
45     CapSense_CSD_Start();
46
47     /* The custom fonts for the bargraph need to be manually loaded */
48     LCD_LoadCustomFonts(LCD_customFonts);
49
50     LCD_Position(0u, 0u);
51     LCD_PrintString("CSD01");
```



```
50 LCD_Position(Ou, Ou);
51 LCD_PrintString("CSD01");
52
53 /* Enable global interrupts */
54 CyGlobalIntEnable;
55
56 /* Initialize baselines */
57 CapSense_CSD_InitializeAllBaselines();
58
59 while(1u)
60 {
61     /* Update all baselines */
62     CapSense_CSD_UpdateEnabledBaselines();
63
64     /* Start scanning all enabled sensors */
65     CapSense_CSD_ScanEnabledWidgets();
66
67     /* Wait for scanning to complete */
68     while(CapSense_CSD_IsBusy() != 0);
69
70     /* Display CapSense state using LED/LCD */
71     CapSense_DisplayState();
72 }
73 }
74
```

```
75 | /*****  
76 | * Function Name: CapSense_DisplayState  
77 | *****/  
78 | * Summary:  
79 | * Function performs following functions:  
80 | *   Display Buttons' state using LEDs and Slider state using LCD bargraph  
81 | *  
82 | * Parameters:  
83 | *   None  
84 | *  
85 | * Return:  
86 | *   None  
87 | *  
88 | *****/  
89 | void CapSense_DisplayState(void)  
90 | {  
91 |     /* Display BUTTON0 state */  
92 |     if (CapSense_CSD_CheckIsWidgetActive(CapSense_CSD_BUTTON0__BTN))  
93 |     {  
94 |         LED1_Write(1u);  
95 |     }  
96 |     else  
97 |     {  
98 |         LED1_Write(0u);  
99 |     }  
100 | }
```



```
100
101  /* Display BUTTON1 state */
102  if (CapSense_CSD_CheckIsWidgetActive(CapSense_CSD_BUTTON1__BTN))
103  {
104      LED2_Write(1u);
105  }
106  else
107  {
108      LED2_Write(0u);
109  }
110
111  /* Find Slider Position */
112  curPos = CapSense_CSD_GetCentroidPos(CapSense_CSD_LINEARSLIDERO__LS);
113
114  /* Reset position */
115  if(curPos == 0xFFFFu)
116  {
117      curPos = 0u;
118  }
119
120  /* Move bargraph */
121  if (curPos != oldPos)
122  {
123      oldPos = curPos;
124      /* Display Slider bargraph */
125      if (curPos != 0u)
```

```
114  /* Reset position */
115  if(curPos == 0xFFFFu)
116  {
117      curPos = 0u;
118  }
119
120  /* Move bargraph */
121  if (curPos != oldPos)
122  {
123      oldPos = curPos;
124      /* Display Slider bargraph */
125      if (curPos != 0u)
126      {
127          LCD_DrawHorizontalBG(0u, 9u, 6u, curPos >> 2);
128      }
129
130      /* Display Slider position value */
131      LCD_Position(1u, 10u);
132      LCD_PrintInt16(curPos);
133  }
134 }
135
136
137 /* [] END OF FILE */
138
```



Expected output on LCD

## References

- [1] Application Note AN2233a, "Capacitive Switch Scan," Cypress Semiconductor**
- [2] Application Note AN2403, "Signal-to-Noise Ratio Requirement for CapSense Applications," Cypress Semiconductor**
- [3] Application Note AN2292, "Layout Guidelines for PSoC CapSense," Cypress Semiconductor**
- [4] Application Note AN2398, "Waterproof Capacitive Sensing," Cypress Semiconductor**
- [5] Application Note AN2360, "Power Consumption and Sleep Considerations with CapSense," Cypress Semiconductor**

## References (continue)

- [6] Application Note AN2318, "EMC Design Considerations for PSoC CapSense Applications," Cypress Semiconductor**
- [7] Application Note AN2394, "CapSense Best Practices," Cypress Semiconductor**
- [8] Application Note AN2397, "CapSense Data Viewing Tool," Cypress Semiconductor**



На сайті фірми Cypress знаходиться більше **200** Application Notes і Reference Designs, які ілюструють області застосування мікроконтролерів PSoC.

Design Support - Microsoft Internet Explorer

Address: <http://www.cypress.com/portal/server.pt?space=CommunityPage&control=SetCommunity&Communi>

**Design Resources**

Select one of the following materials to help you design-in Cypress products: Application Notes, Datasheets, Developer Kits, Errata Updates, Evaluation Boards, Models, Reference Designs, Software & Drivers and Technical Articles.

Select Product Group: -- All Product Groups --

Select Product Family: -- All Product Families --  
 Application Specific Clocks  
 Async SRAMs  
 Automotive Products  
 Backplane Interface & Clock Mgmt  
 Bluetooth Solutions

Apply Filter

Application Notes	Datasheets	Developer Kits	Errata Update	Evaluation Boards
Models	More Resources	Reference Designs	Software and Drivers	Technical Articles

**Technical Support**

**Product Family** | **Descriptive Name** | **Date** | **Downloads**

Product Family	Descriptive Name	Date	Downloads
PSoC Mixed-Signal Array	AN2267a - Standard - Single Cell Li-Ion Battery Charger using CY8C21xxx	Apr 19, 2005	AN2267A.PDF AN2267A.ZIP
PSoC Mixed-Signal Array	AN2260 - Standard - Rapid NiCd/NiMH Battery Charger and DC Brushed Motor Controller for Autonomous Appliances	Apr 15, 2005	AN2260.PDF AN2260.ZIP
PSoC Mixed-Signal Array	AN2026b - Support - In-System Serial Programming Protocol CY8C24794 and CY8C29xxx	Apr 8, 2005	AN2026B.PDF
PSoC Mixed-Signal Array	AN2266 - Support - 16-Bit PWM/PWM-DACs using One Digital PSoC(TM) Block	Apr 8, 2005	AN2266.PDF AN2266.ZIP
PSoC Mixed-Signal Array	AN2279 - Support - Dynamic I2C Addressing Implemented with I2C Hardware User Modules	Apr 8, 2005	AN2279.PDF AN2279.ZIP
PSoC Mixed-Signal Array	AN2267 - Standard - Single Cell Li-Ion Battery Charger	Apr 1, 2005	AN2267.PDF AN2267.ZIP
PSoC Mixed-Signal Array	AN2222a - Support - Flex-Pod Soldering Guide	Mar 31, 2005	AN2222A.PDF
PSoC Mixed-Signal Array	AN2233a - Support - Capacitive Switch Scan	Mar 31, 2005	AN2233A.PDF
PSoC Mixed-Signal Array	AN2276 - Support - Binary Weighted Single-Pole IIR Low-Pass Filters	Mar 29, 2005	AN2276.PDF AN2276.ZIP
PSoC Mixed-Signal Array	AN2277 - Support - Capacitive Front Panel Display Demonstration	Mar 29, 2005	AN2277.PDF AN2277.ZIP

Found 201 items 1 - 10 | 11 - 20 | 21 - 30 | 31 - 40 | 41 - 50 | 51 - 60 | 61 - 70 | 71 - 80 | 81 - 90 | 91 - 100 | see 1 - 100 | next 100

Contact Us | Privacy | Terms & Conditions | How to Buy | 日本語 | 中文

© Copyright 1995-2005. Cypress Semiconductor Corporation. All rights reserved.



# Мікропроцесорн а техніка (лекція 3, кінець) Благітко Б.Я. 2019 р.

