

Kazakh-American University



Generations of computer And Characteristics of a computer

Nurakhmetova A.E.

Generations of computer

Computer can be classified into five types according to generations i.e. time period

- . First generation computer
- . Second generation computer
- . Third generation computer
- . Fourth generation computer
- . Fifth generation computer

. First generation computer

Period : 1945 – 1956

Inventor : Lee de Forest

Main processing device : Vacuum tubes

Vacuum tube

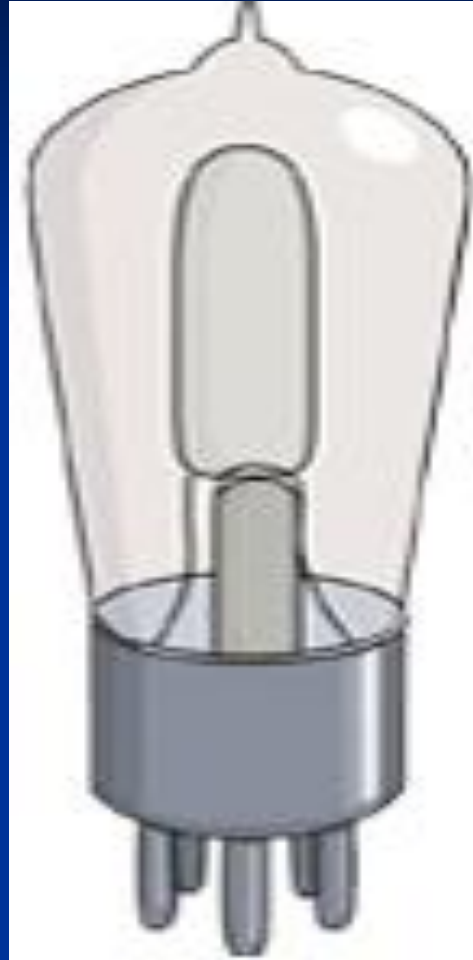

Vacuum tube

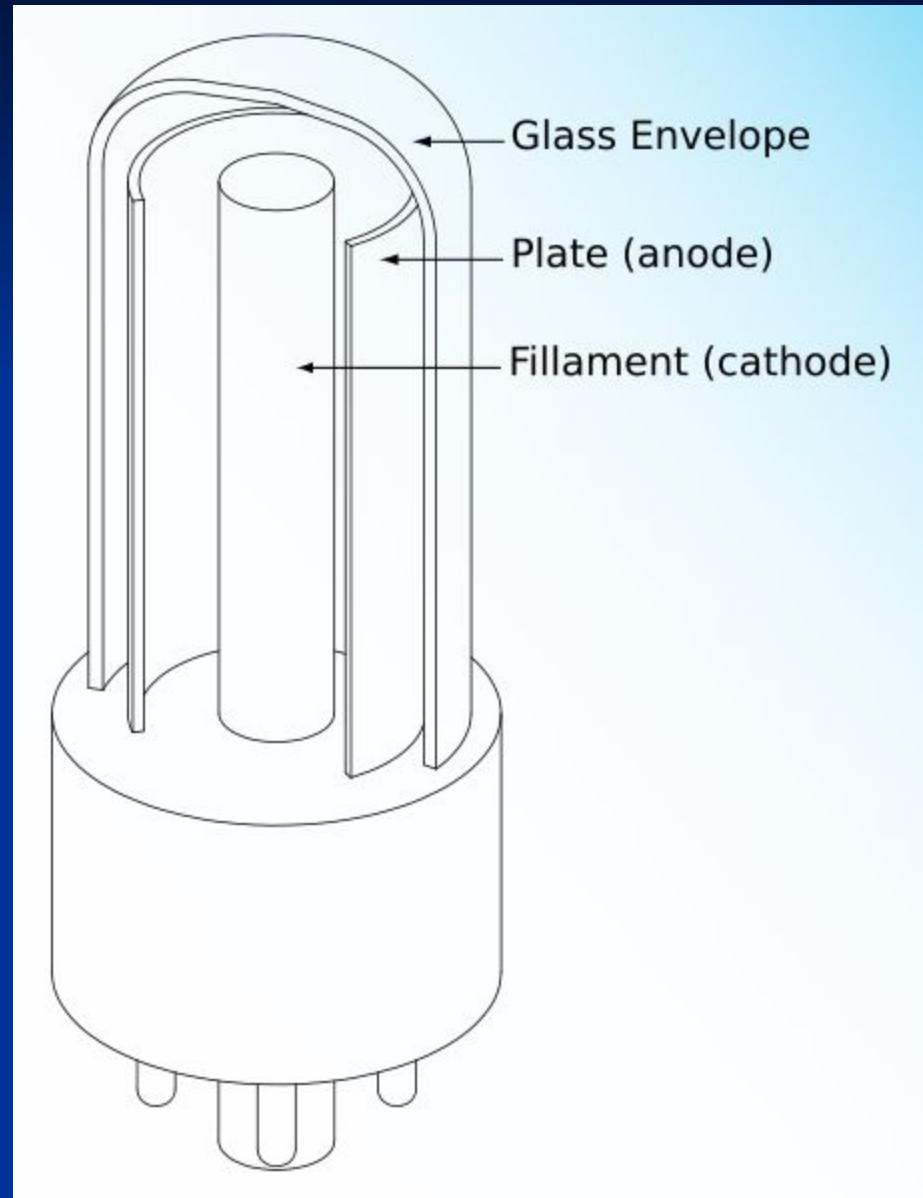

Vacuum tube

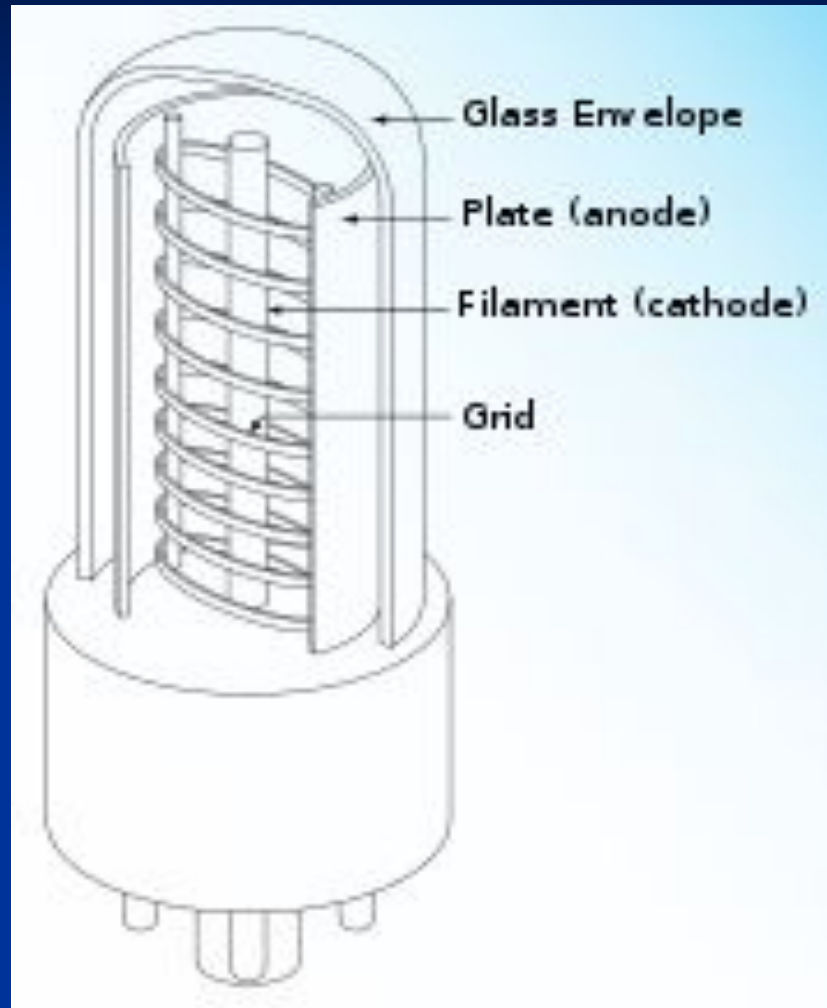

Vacuum tube



Vacuum tubes



Observing Vacuum tube

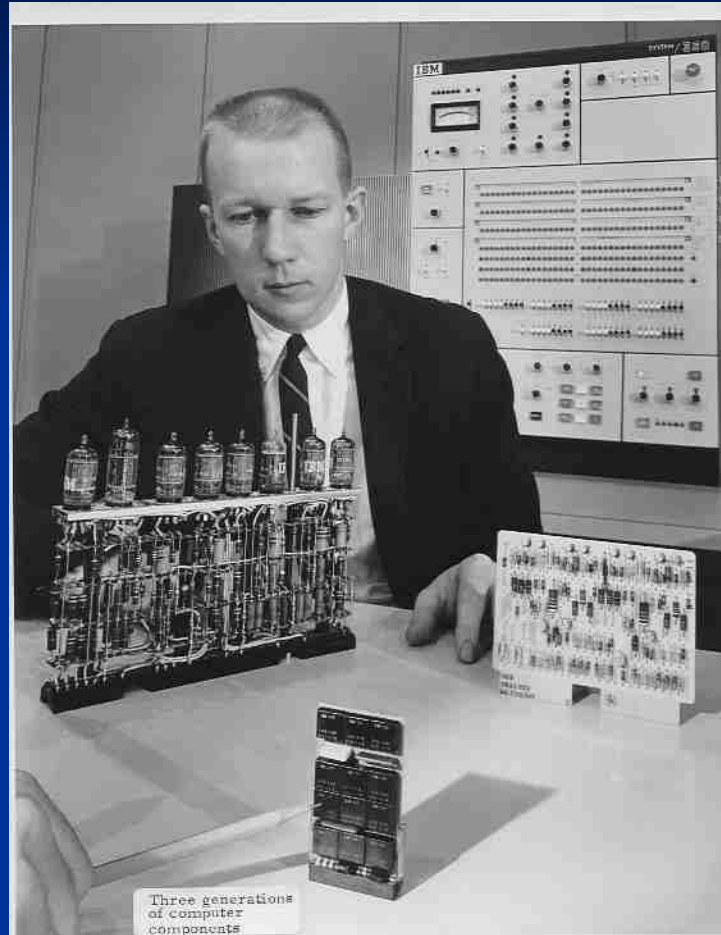

Observing Vacuum tube



Vacuum tube tester



Punched cards



Punched card voting



Punched card decks



Punched cards models

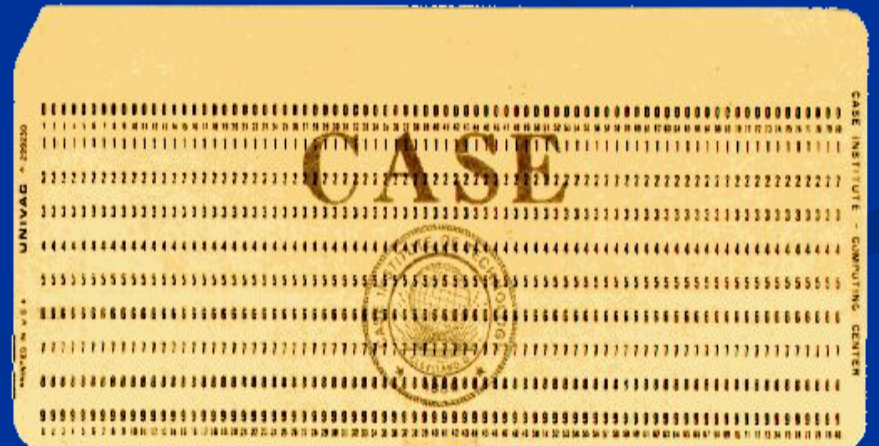
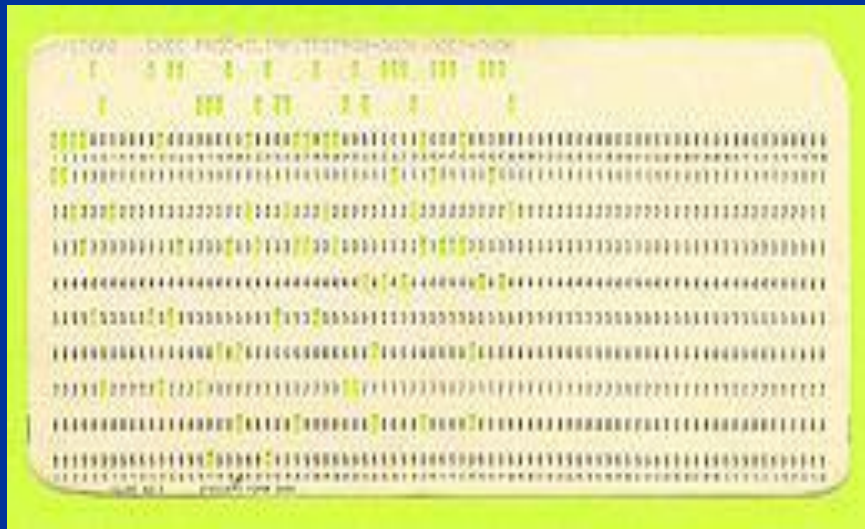
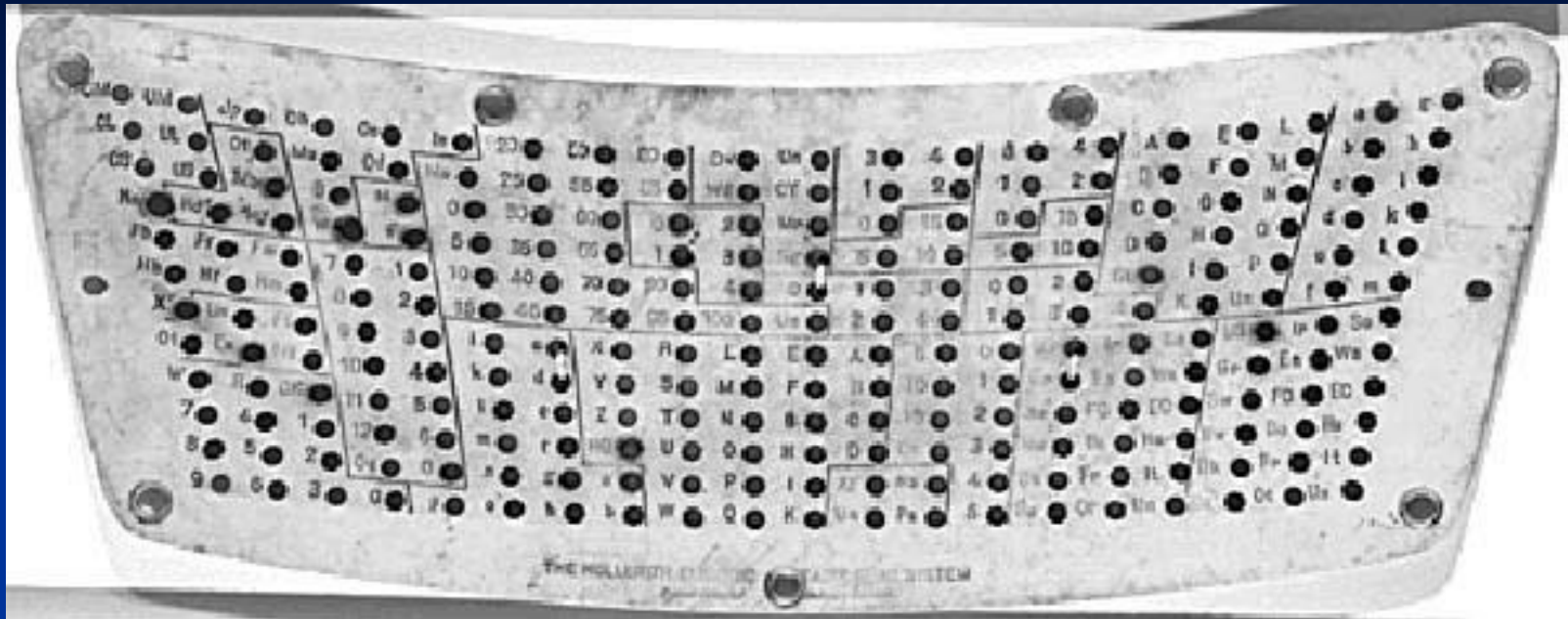

Large punched cards



. First generation computer

Advantages :

- . It was only electronic device
- . First device to hold memory

Disadvantages :

- . Too bulky i.e large in size
- . Vacuum tubes burn frequently
- . They were producing heat
- . Maintenance problems

Too bulky i.e large in size



Vacuum tubes burn frequently



Maintenance problems



. Second generation computer

Period : 1956 – 1963

Inviter : William Shockley

Main processing device : Transistor

Storage media : Magnetic disc

Transistor

1

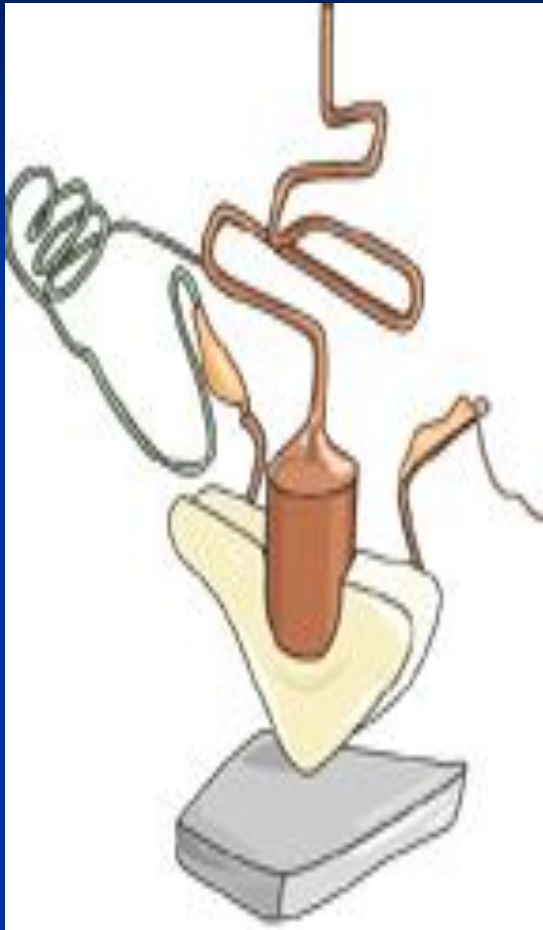

2



Transistor board



. Second generation computer

Advantages :

- . Size reduced considerably
- . The very fast
- . Very much reliable

Disadvantages :

- . They over heated quickly
- . Maintenance problems

Third generation computer

Period : 1964 – 1971

Inviter : Jack Kilby

Robert Noyce

Main processing device : IC (integrated circuit)

Storage media : Floppies

IC (integrated circuit)

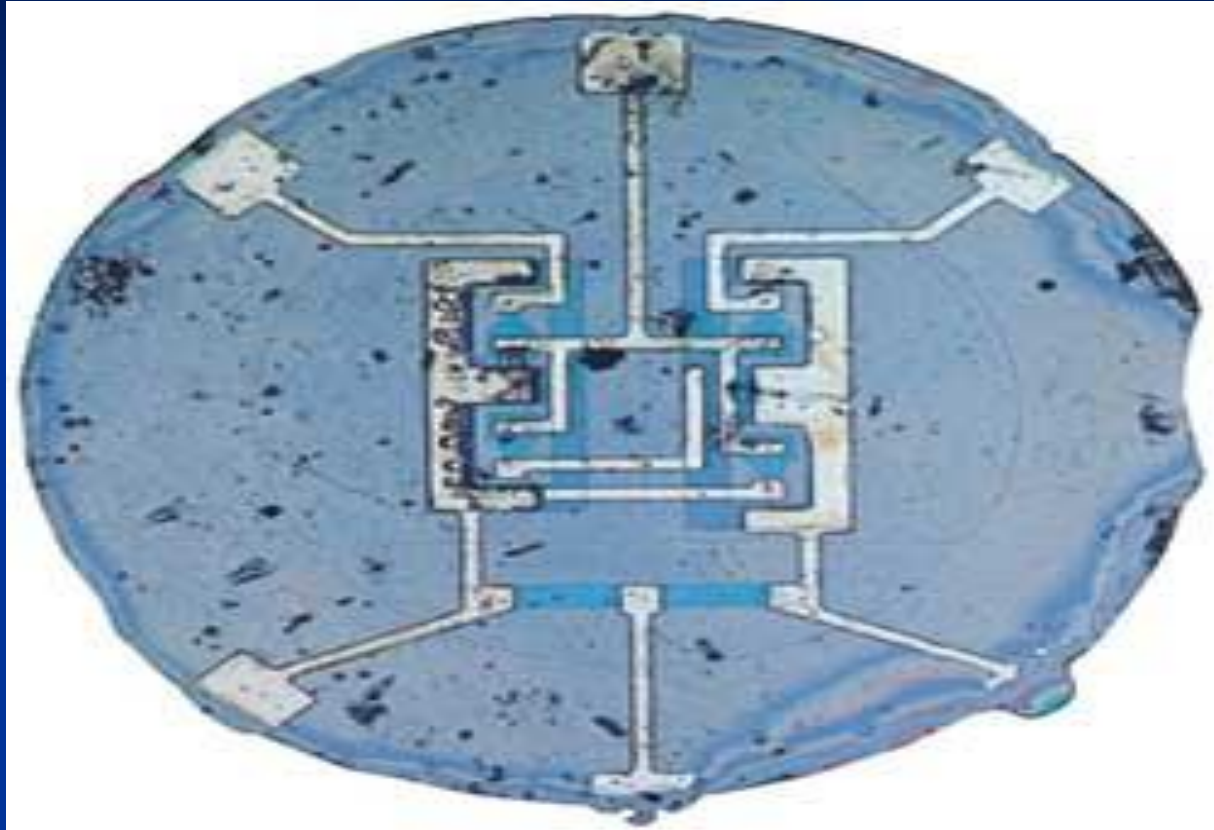

ICs (integrated circuits)

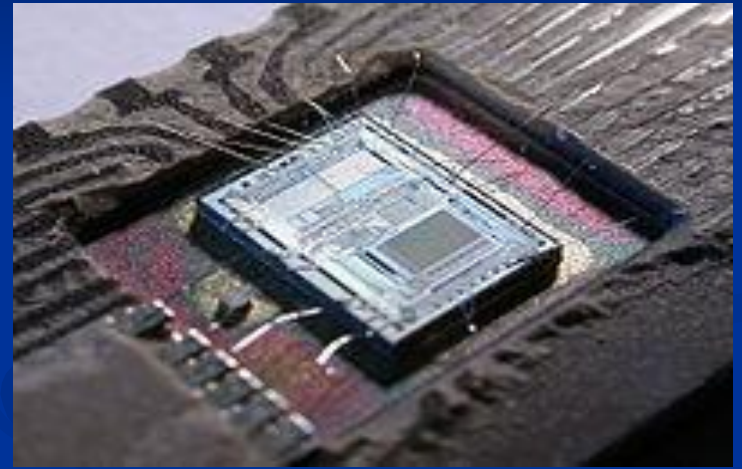
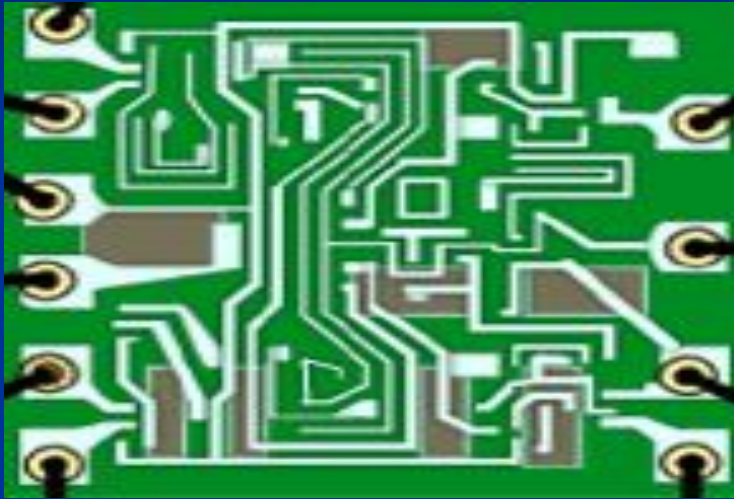

IC (integrated circuit)



. Third generation computer

Advantages :

- . ICs are very small in size
- . Improved performance
- . Production cost cheap

Disadvantages :

- . ICs are sophisticated

Fourth generation computer

Period : 1971– present

Inviter : Ted Hoff

Main processing device : ICs with VLSI
(Very Large Scale Integration)

Storage media : Floppies, CDs.

ICs with VLSI (Very Large Scale Integration)

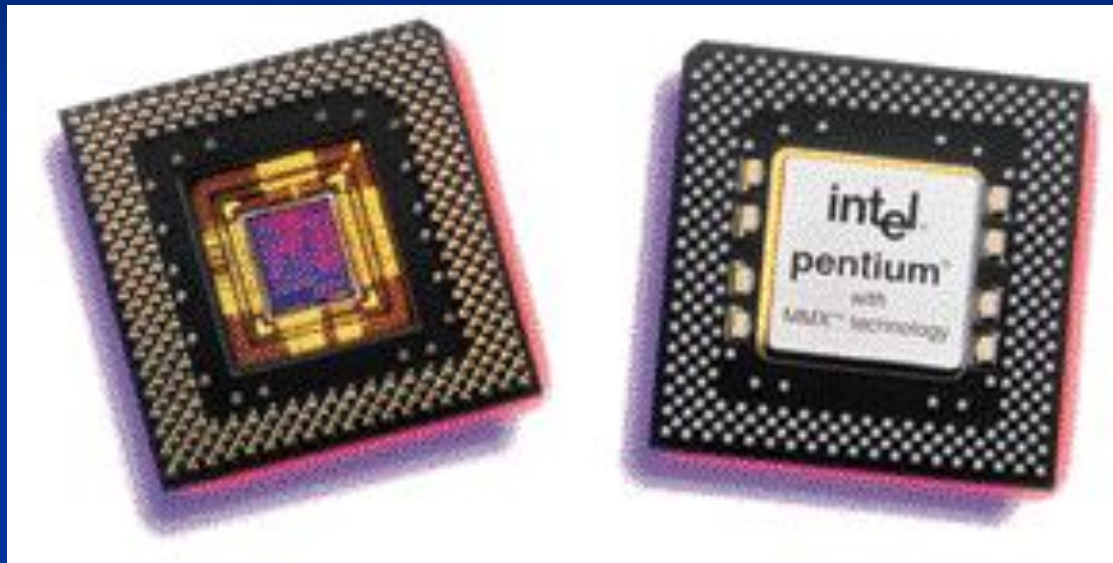

. Fourth generation computer

Advantages :

- . It is a compact
- . Less power consumption
- . Production cost is cheap

Disadvantages :

- . No artificial intelligent.

. Fifth generation computer

Period : present and beyond

Main processing device : ICs with parallel processing

Storage media : Video disks

Advantages :

- . Artificial intelligence
- . Expert system

. First generation computer . Second generation computer

Vacuum tubes

Transistors

. Third generation computer . Fourth generation computer

ICs

ICs with VLSI

. Fifth generation computer

ICs with parallel
processing

Thank you