



Topic 13

«Networks and telecommunications»





Networking

- **Computer network** A collection of computing devices that are connected in various ways in order to communicate and share resources

Usually, the connections between computers in a network are made using physical wires or cables

However, some connections are **wireless**, using radio waves or infrared signals



Networking

- The generic term **node** or **host** refers to any device on a network
- **Data transfer rate** The speed with which data is moved from one place on a network to another
- Data transfer rate is a **key issue** in computer networks



Networking

- Computer networks have opened up an entire frontier in the world of computing called the **client/server model**

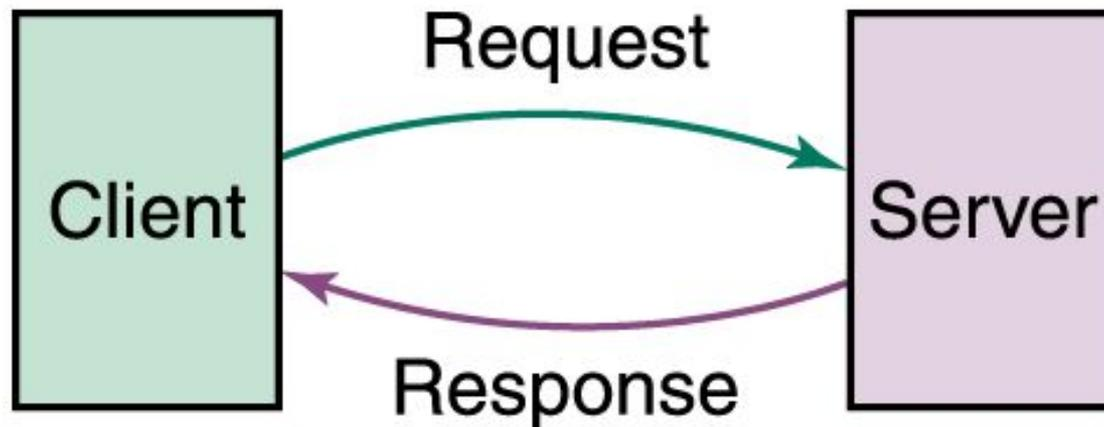

Figure 15.1 Client/Server interaction



Networking

- **File server** A computer that stores and manages files for multiple users on a network
- **Web server** A computer dedicated to responding to requests (from the browser client) for web pages



Types of Networks

- **Local-area network (LAN)** A network that connects a relatively small number of machines in a relatively close geographical area



Types of Networks

- Various configurations, called topologies, have been used to administer LANs
 - **Ring topology** A configuration that connects all nodes in a closed loop on which messages travel in one direction
 - **Star topology** A configuration that centers around one node to which all others are connected and through which all messages are sent
 - **Bus topology** All nodes are connected to a single communication line that carries messages in both directions



Types of Networks

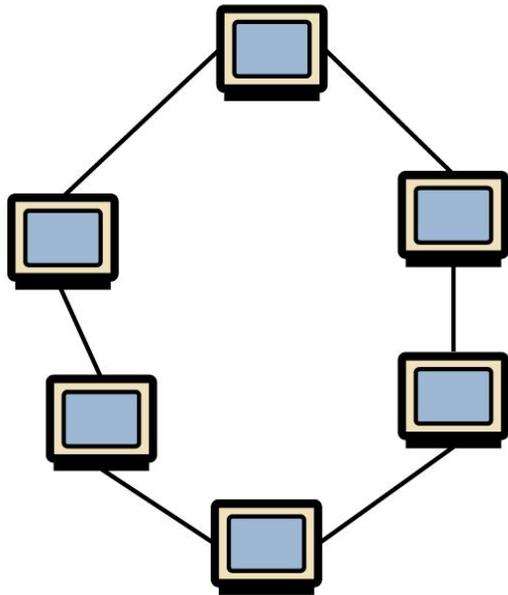

Ring topology

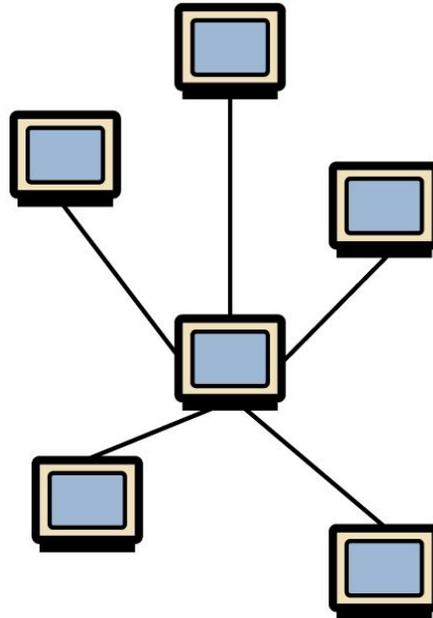

Star topology

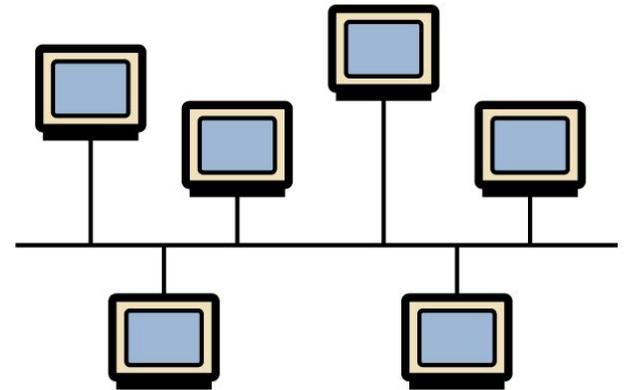

Bus topology

Figure 15.2 Various network topologies

- A bus technology called **Ethernet** has become the industry standard for local-area networks



Types of Networks

- **Wide-area network (WAN)** A network that connects two or more local-area networks over a potentially large geographic distance

Often one particular node on a LAN is set up to serve as a **gateway** to handle all communication going between that LAN and other networks

Communication between networks is called internetworking

The **Internet**, as we know it today, is essentially the ultimate wide-area network, spanning the entire globe



Types of Networks

- **Metropolitan-area network (MAN)** The communication infrastructures that have been developed in and around large cities



So, who owns the Internet?

Well, nobody does. No single person or company owns the Internet or even controls it entirely. As a wide-area network, it is made up of many smaller networks. These smaller networks are often owned and managed by a person or organization. The Internet, then, is really defined by how connections can be made between these networks.

Types of Networks

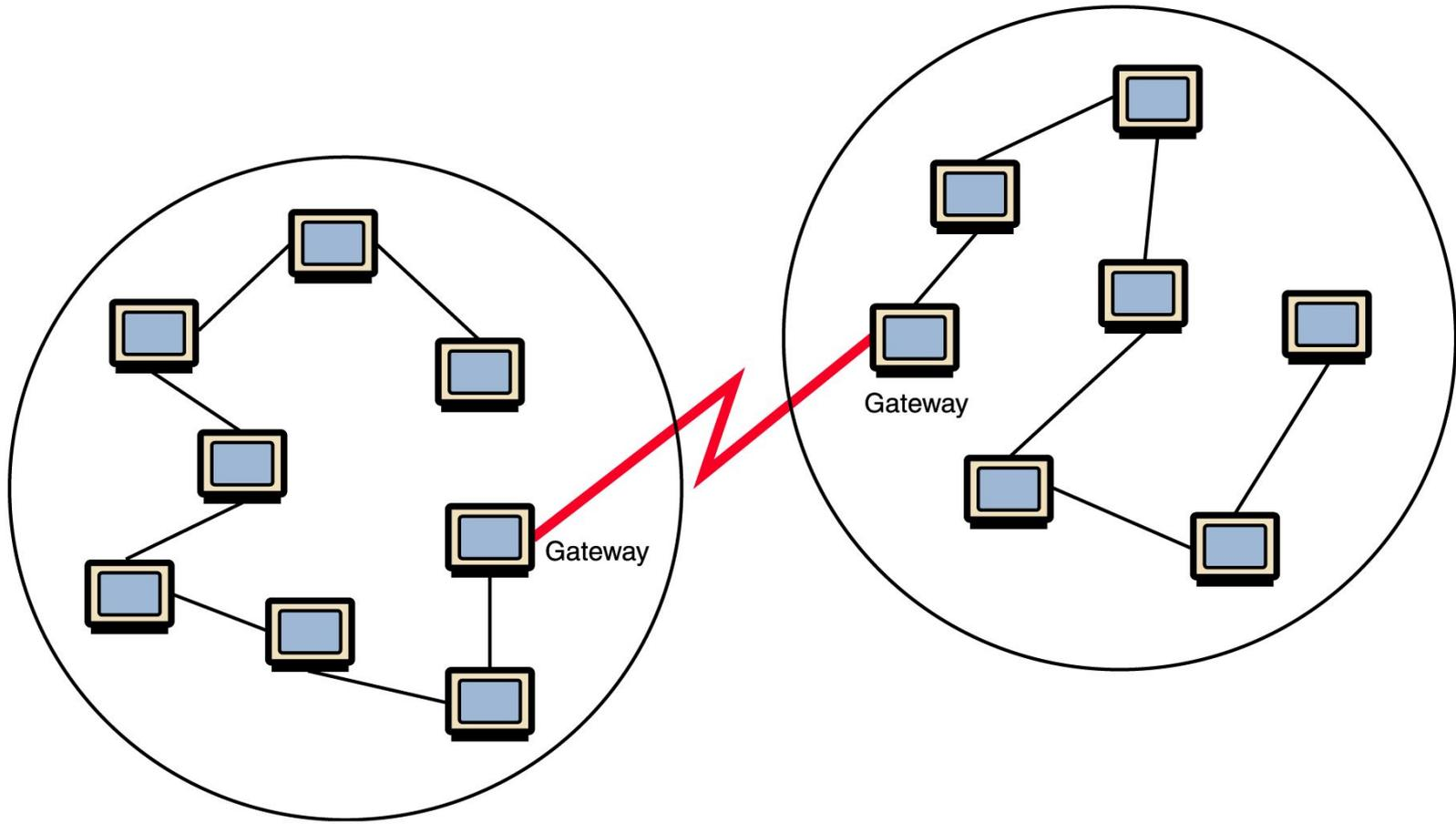

Figure 15.1 Local-area networks connected across a distance to create a wide-area network



Internet Connections

- **Internet backbone** A set of high-speed networks that carry Internet traffic
These networks are provided by companies such as AT&T, GTE, and IBM
- **Internet service provider (ISP)** A company that provides other companies or individuals with access to the Internet



Internet Connections

- There are various technologies available that you can use to connect a home computer to the Internet
 - A **phone modem** converts computer data into an analog audio signal for transfer over a telephone line, and then a modem at the destination converts it back again into data
 - A **digital subscriber line (DSL)** uses regular copper phone lines to transfer digital data to and from the phone company's central office
 - A **cable modem** uses the same line that your cable TV signals come in on to transfer the data back and forth



Internet Connections

- **Broadband** A connection in which transfer speeds are faster than 128 bits per second
 - DSL connections and cable modems are broadband connections
 - The speed for **downloads** (getting data from the Internet to your home computer) may not be the same as **uploads** (sending data from your home computer to the Internet)



Packet Switching

- To improve the efficiency of transferring information over a shared communication line, messages are divided into fixed-sized, numbered **packets**
- Network devices called routers are used to direct packets between networks

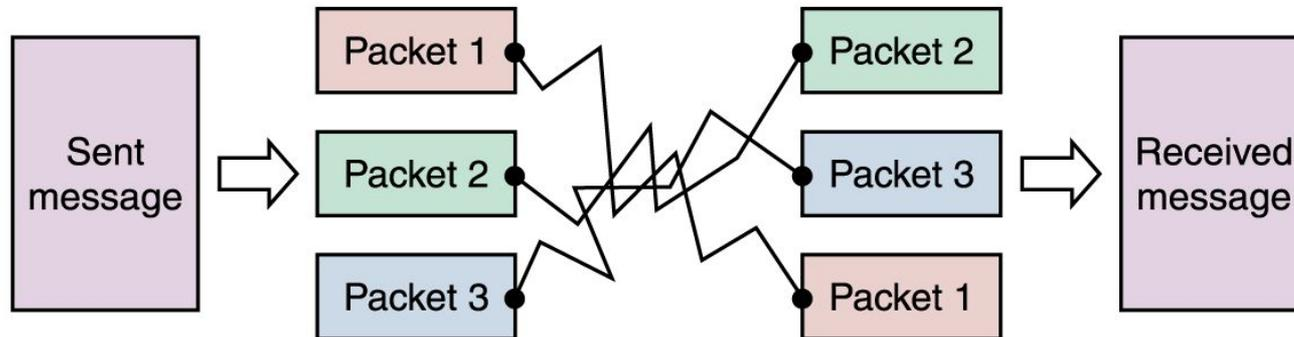

Figure 15.4
Messages sent by packet switching

Message is divided into packets

Packets are sent over the Internet by the most expedient route

Packets are reordered and then reassembled



Open Systems

- **Proprietary system** A system that uses technologies kept private by a particular commercial vendor
One system couldn't communicate with another, leading to the need for
- **Interoperability** The ability of software and hardware on multiple machines and from multiple commercial vendors to communicate
Leading to
- **Open systems** Systems based on a common model of network architecture and a suite of protocols used in its implementation



Open Systems

7	Application layer
6	Presentation layer
5	Session layer
4	Transport layer
3	Network layer
2	Data Link layer
1	Physical layer

Figure 15.5 The layers of the OSI Reference Model

- The International Organization for Standardization (ISO) established the **Open Systems Interconnection (OSI) Reference Model**
- Each layer deals with a particular aspect of network communication



Network Protocols

- A *protocol* is a set of rules and formats that govern the communication between communicating peers
 - set of valid messages
 - meaning of each message
- Network protocols are layered such that each one relies on the protocols that underlie it
- Sometimes referred to as a **protocol stack**

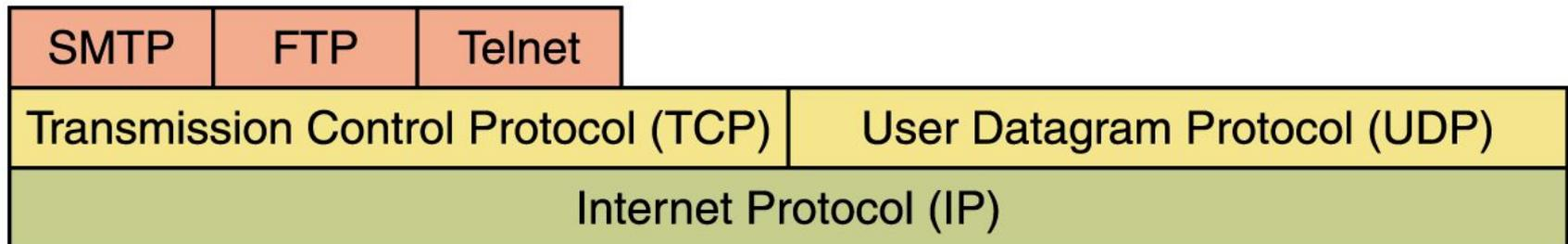

Figure 15.6 Layering of key network protocols



TCP/IP

- TCP stands for **Transmission Control Protocol**
TCP software breaks messages into packets, hands them off to the IP software for delivery, and then orders and reassembles the packets at their destination
- IP stands for **Internet Protocol**
IP software deals with the routing of packets through the maze of interconnected networks to their final destination



TCP/IP (cont.)

- UDP stands for **User Datagram Protocol**
 - It is an alternative to TCP
 - The main difference is that TCP is highly reliable, at the cost of decreased performance, while UDP is less reliable, but generally faster



High-Level Protocols

- Other protocols build on the foundation established by the TCP/IP protocol suite
 - Simple Mail Transfer Protocol (SMTP)
 - File Transfer Protocol (FTP)
 - Telnet
 - Hyper Text Transfer Protocol (http)



MIME Types

- Related to the idea of network protocols and standardization is the concept of a file's MIME type
 - MIME stands for **Multipurpose Internet Mail Extension**
 - Based on a document's MIME type, an application program can decide how to deal with the data it is given



MIME Types

Protocol	Port
Echo	7
File Transfer Protocol (FTP)	21
Telnet	23
Simple Mail Transfer Protocol (SMTP)	25
Domain Name Service (DNS)	53
Gopher	70
Finger	79
Hyper Text Transfer Protocol (HTTP)	80
Post Office Protocol (POP3)	110
Network News Transfer Protocol (NNTP)	119
Internet Relay Chat (IRC)	6667

Figure 15.7
Some protocols
and the ports
they use



Firewalls

- **Firewall** A machine and its software that serve as a special gateway to a network, protecting it from inappropriate access
 - Filters the network traffic that comes in, checking the validity of the messages as much as possible and perhaps denying some messages altogether
 - Enforces an organization's **access control policy**



Firewalls

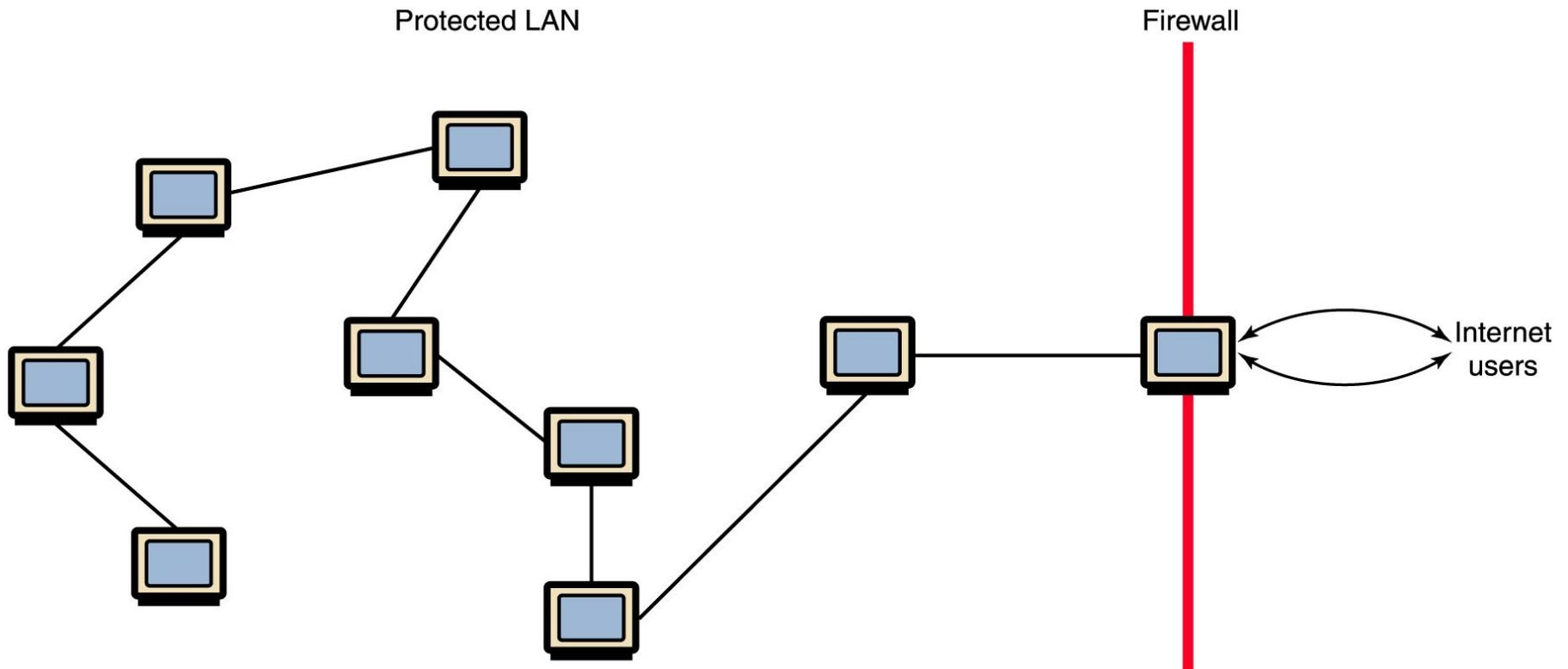

Figure 15.8 A firewall protecting a LAN



Network Addresses

- **Hostname** A unique identification that specifies a particular computer on the Internet

For example

`matisse.csc.villanova.edu`

`condor.develocorp.com`



Network Addresses

- Network software translates a hostname into its corresponding IP address

For example

205.39.145.18



Network Addresses

- An **IP address** can be split into
 - **network address**, which specifies a specific network
 - **host number**, which specifies a particular machine in that network

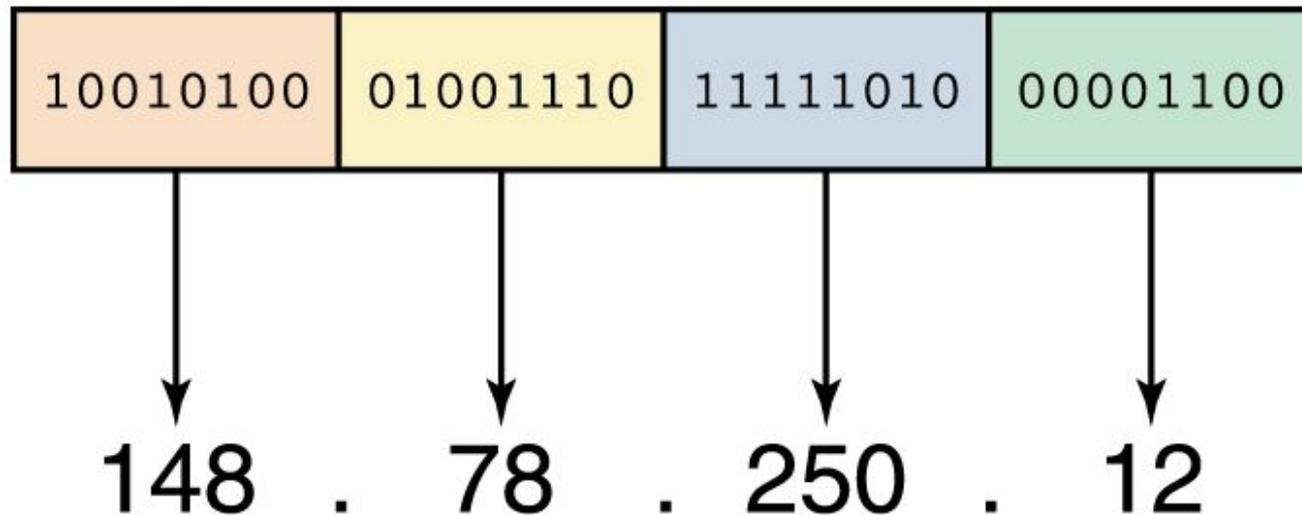

Figure 15.9
An IP address is stored in four bytes



Domain Name System

- A hostname consists of the computer name followed by **the domain name**
- `csc.villanova.edu` is the domain name
 - A domain name is separated into two or more sections that specify the organization, and possibly a subset of an organization, of which the computer is a part
 - Two organizations can have a computer named the same thing because the domain name makes it clear which one is being referred to



Domain Name System

- The very last section of the domain is called its **top-level domain (TLD)** name

Top-Level Domain	General Purpose	New TLDs	General Purpose
.com	U.S. Commercial	.biz	Business
.net	Network	.info	Information
.org	Nonprofit organization	.pro	Professional
.edu	U.S. Educational	.museum	Museums
.int	International	.aero	Aerospace industry
.mil	U.S. Military	.coop	Cooperative
.gov	U.S. Government		

Figure 15.10 Top-level domains, including some relatively new ones



Domain Name System

- Organizations based in countries other than the United States use a top-level domain that corresponds to their two-letter country codes

Country Code TLD	Country
.au	Australia
.br	Brazil
.ca	Canada
.gr	Greece
.in	India
.ru	Russian Federation
.uk	United Kingdom

Figure 15.11

Some of the top-level domain names based on country codes



Domain Name System

- The **domain name system** (DNS) is chiefly used to translate hostnames into numeric IP addresses
 - DNS is an example of a distributed database
 - If that server can resolve the hostname, it does so
 - If not, that server asks another domain name server

