

Business Process Management: Concepts, Languages, Architectures

Second Edition

Mathias Weske

Legal Notice

- This PowerPoint file contains figures used in
 - Mathias Weske, Business Process Management: Concepts, Languages, Architectures 2012, XIV, 403 p. 300 illus., Hardcover ISBN: 978-3-642-28615-5, eBook ISBN: 978-3-642-28616-2 © Springer-Verlag Berlin Heidelberg 2012, 2007
- Each slide contains one picture in PNG-format with caption and copyright notice. It is illegal to remove the copyright notice from any of the figures.
- Commercial use in any form is not allowed without prior written approval by Springer-Verlag
- Teaching material can be found at BPM Academic Initiative, <http://academic.signavio.com>

Best regards,
Mathias Weske

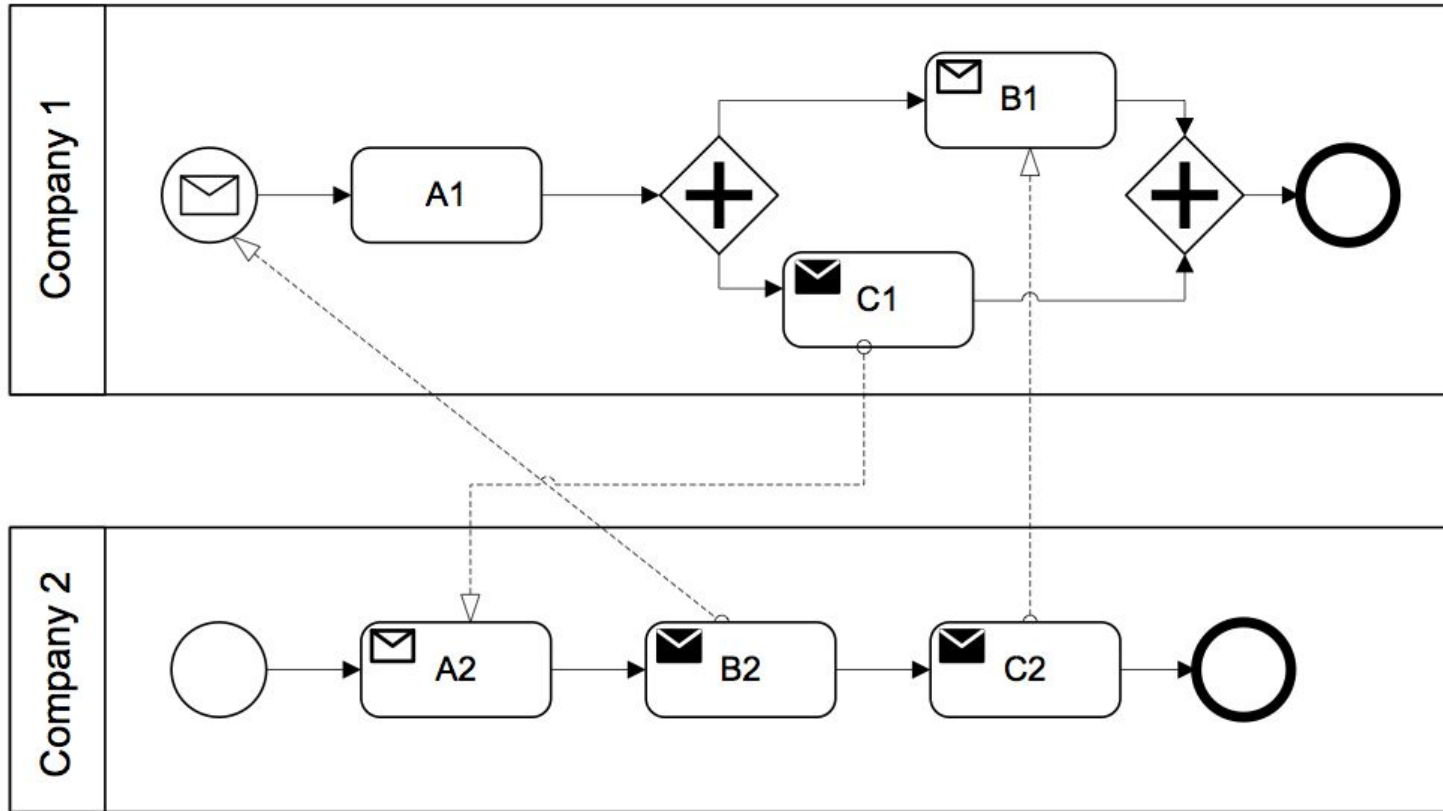
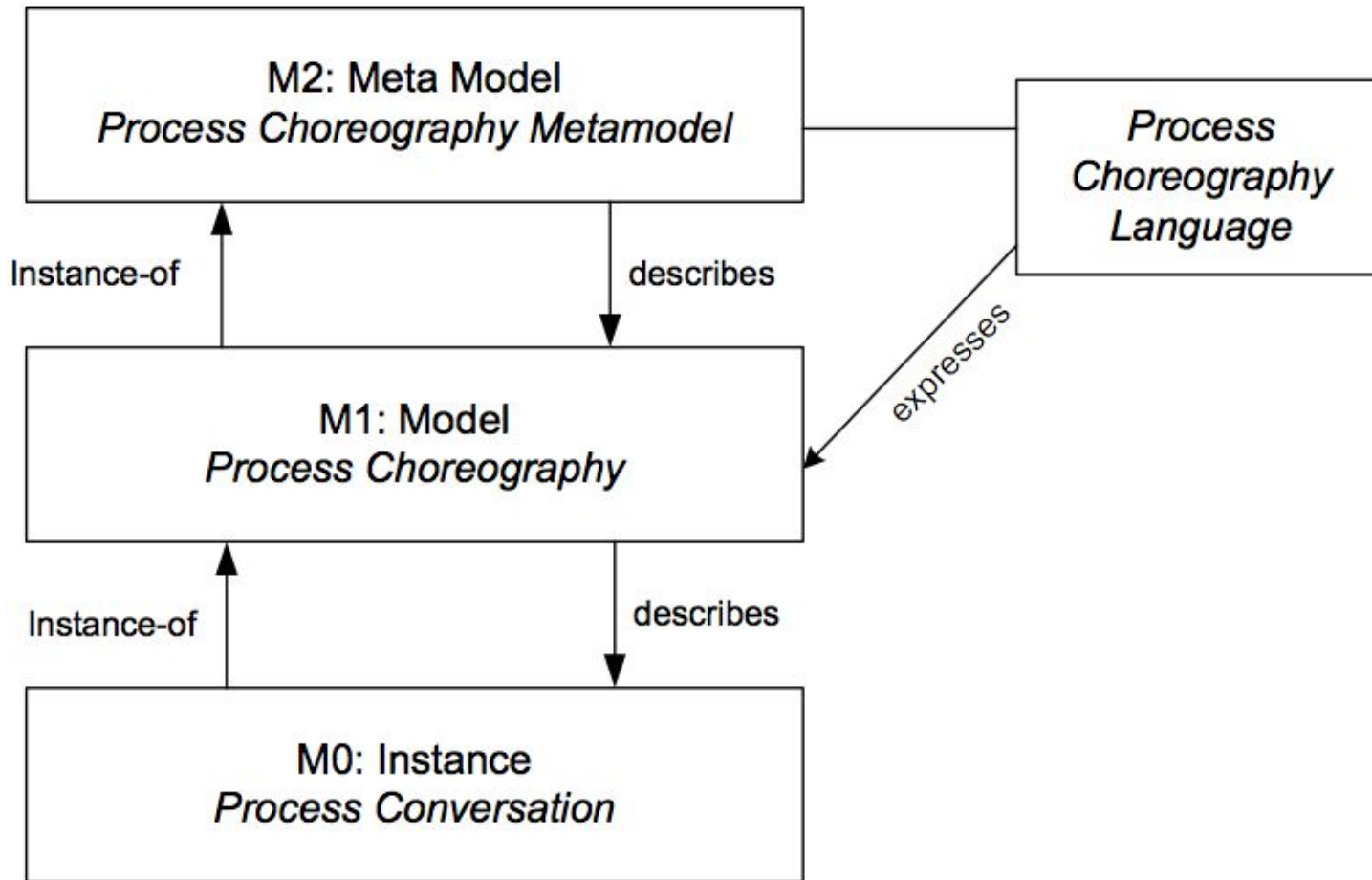

Fig. 5.1. Deadlock of interacting process orchestrations



M. Weske: Business Process Management,
© Springer-Verlag Berlin Heidelberg 2012, 2007

Fig. 5.2. MOF levels of process choreographies

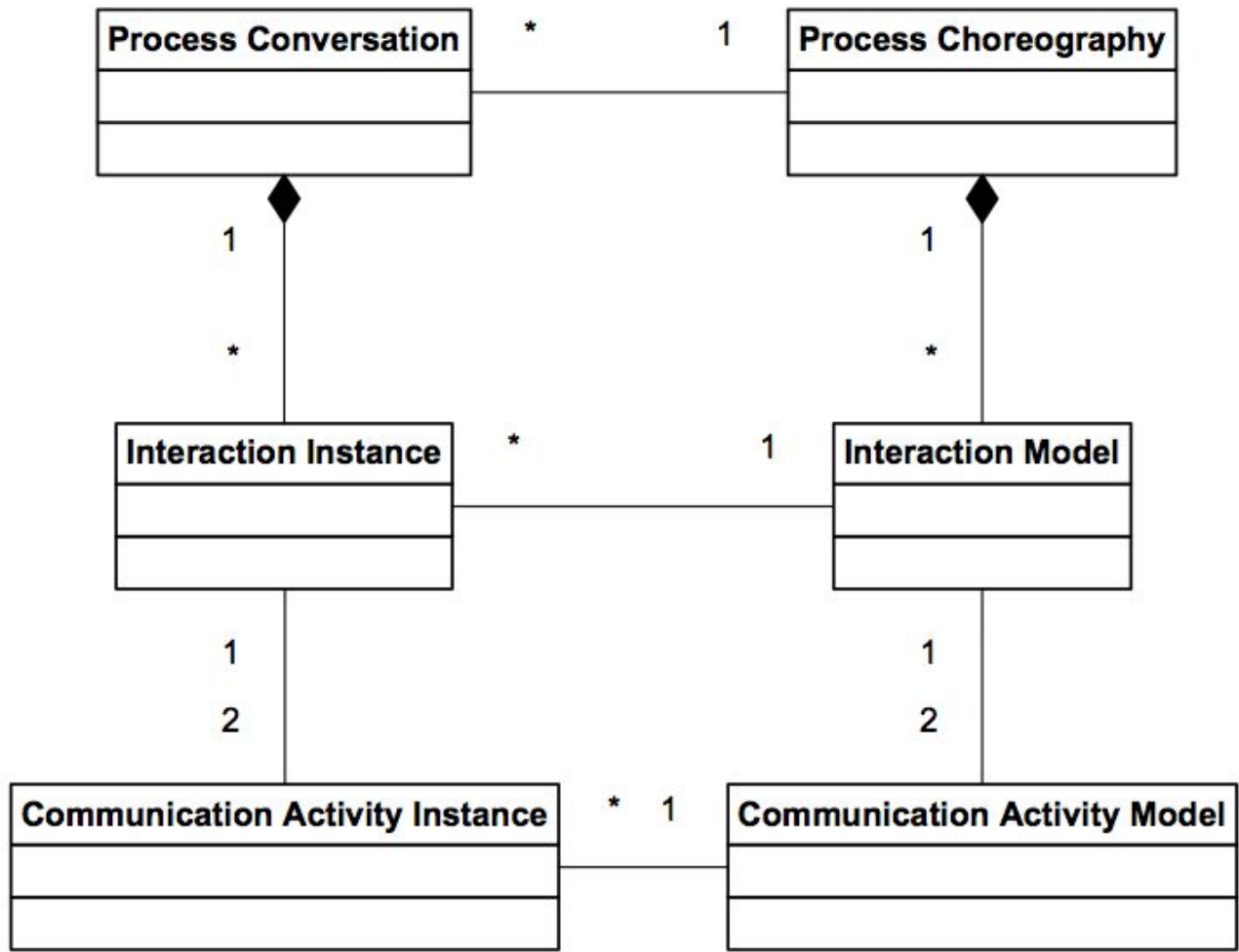
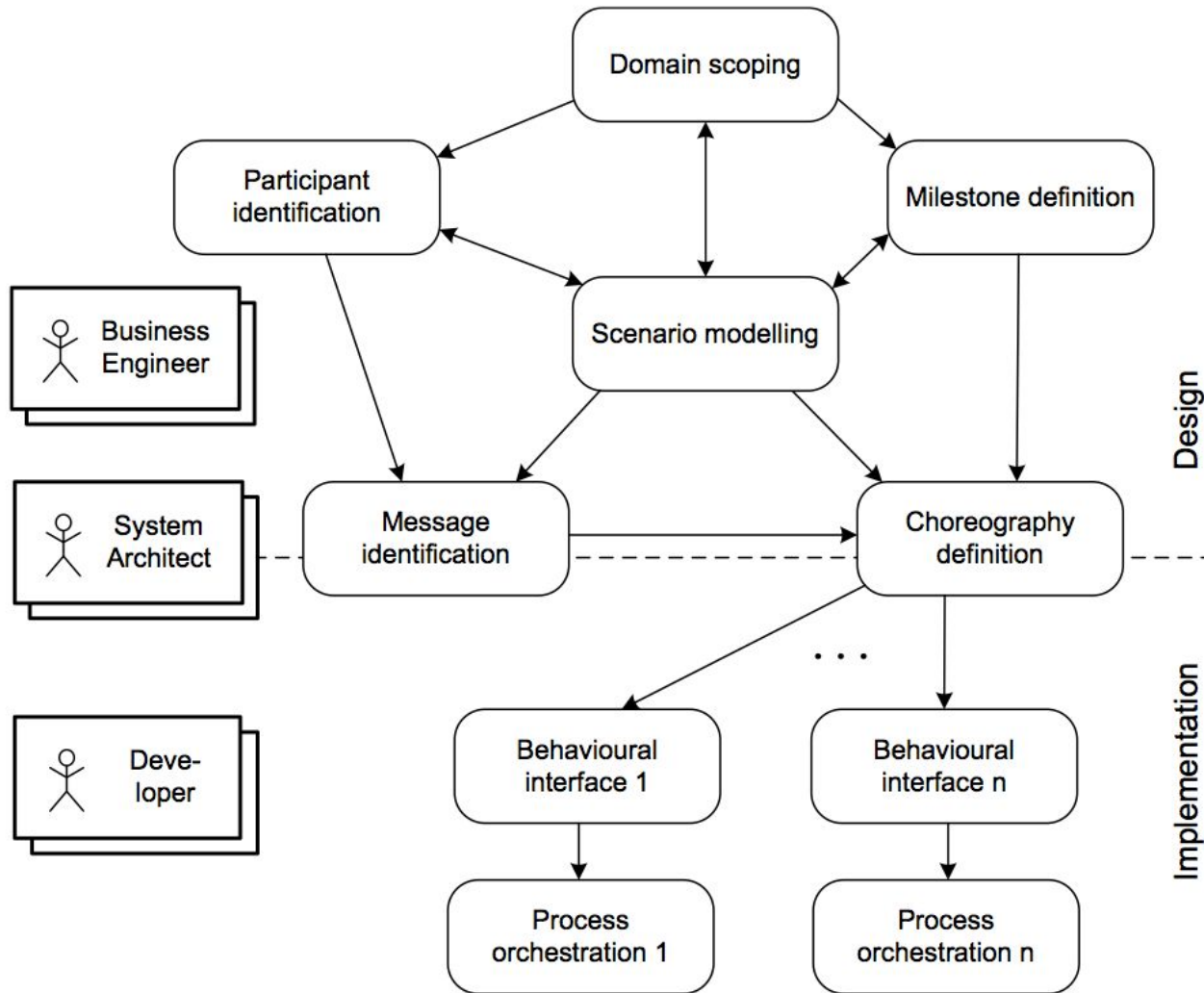

Fig. 5.3. Process choreography conceptual model

M. Weske: Business Process Management,
© Springer-Verlag Berlin Heidelberg 2012, 2007



M. Weske: Business Process Management,
© Springer-Verlag Berlin Heidelberg 2012, 2007

Fig. 5.4. Phases during choreography design and implementation

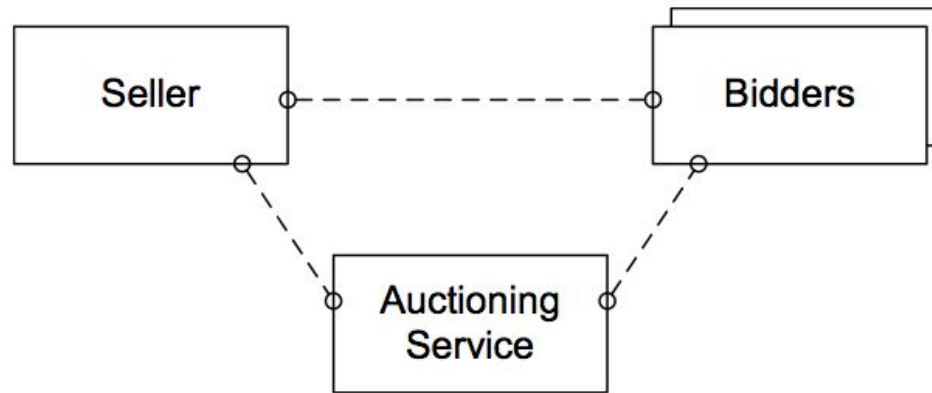

Fig. 5.5. High-level structural model of participants in bidding scenario

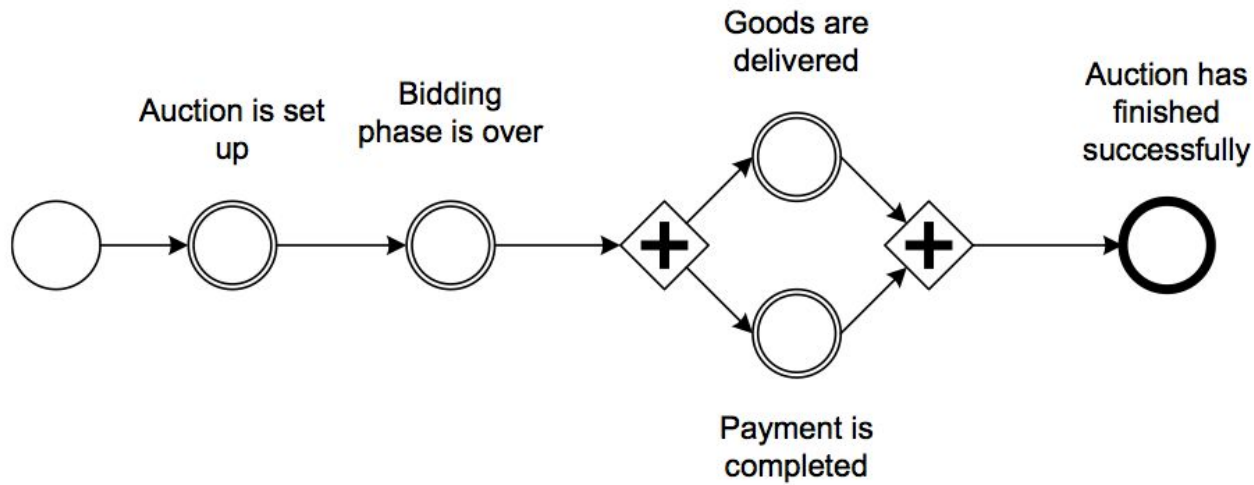
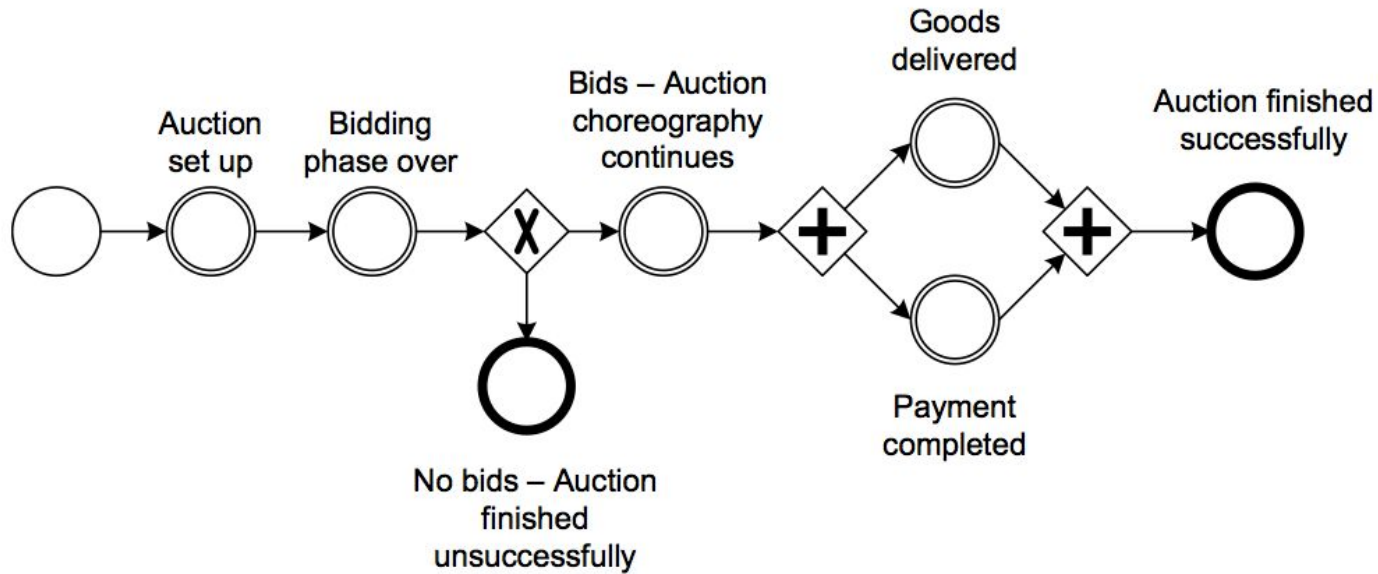
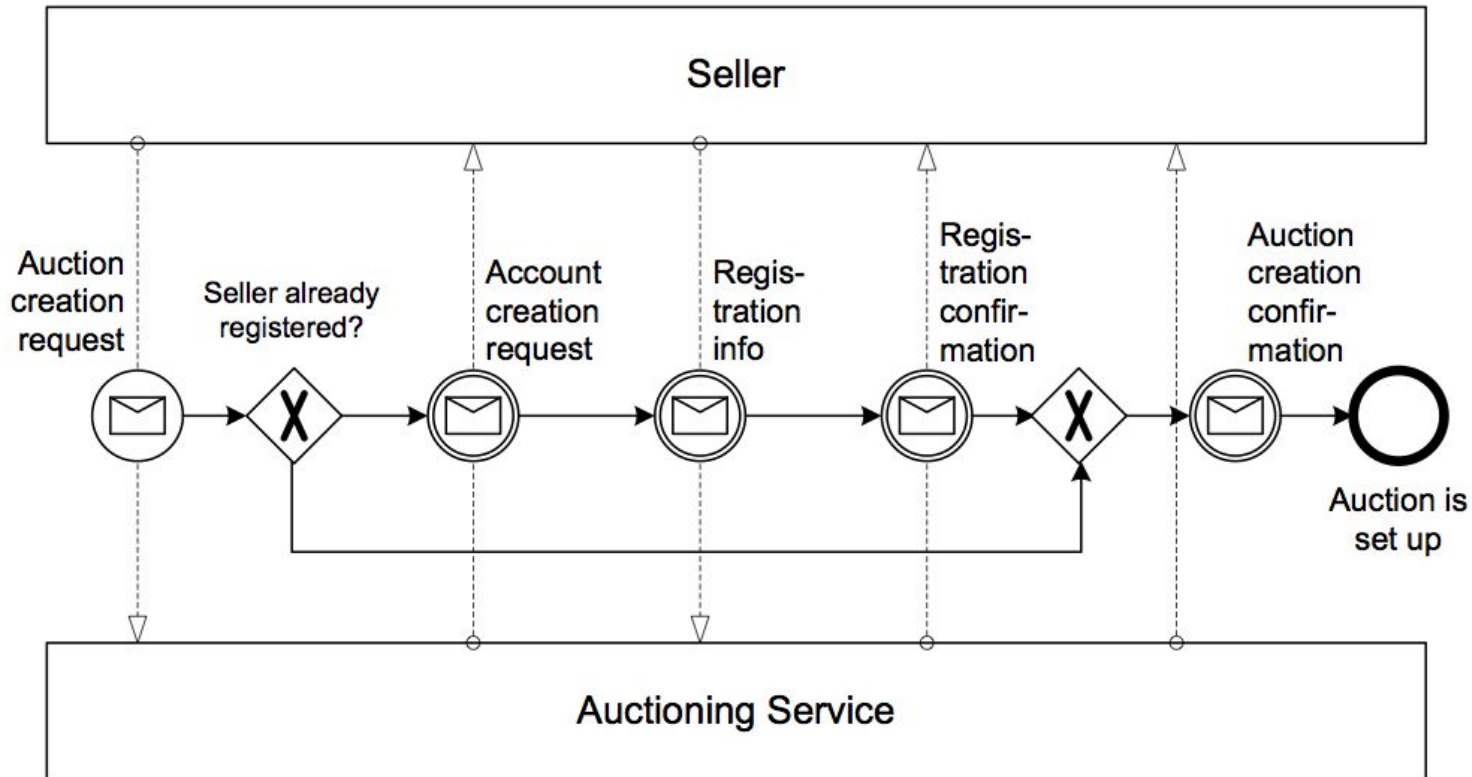

Fig. 5.6. High-level behavioural model for bidding scenario, represented by milestones



M. Weske: Business Process Management,
© Springer-Verlag Berlin Heidelberg 2012, 2007

Fig. 5.7. High-level behavioural model for bidding scenario, with different outcomes



M. Weske: Business Process Management,
© Springer-Verlag Berlin Heidelberg 2012, 2007

Fig. 5.8. Collaboration scenario: reaching milestones through interactions

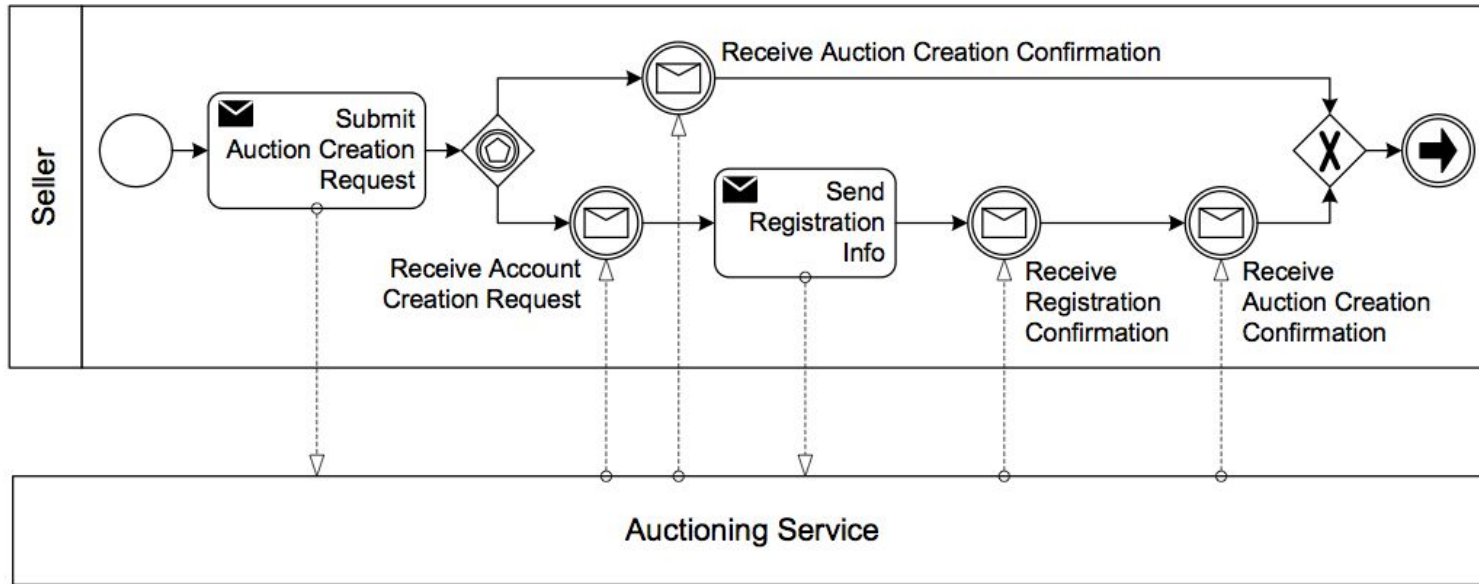
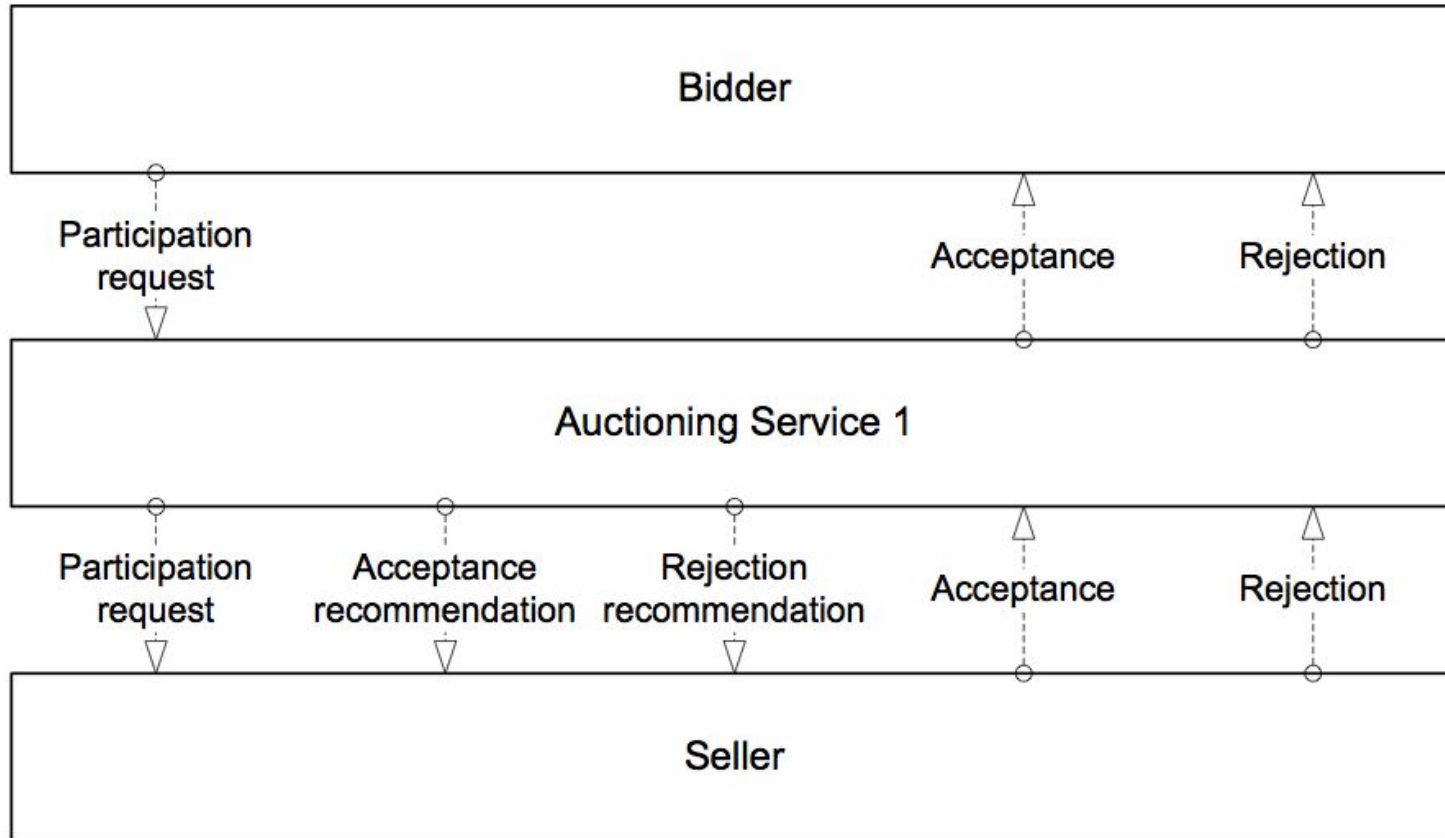
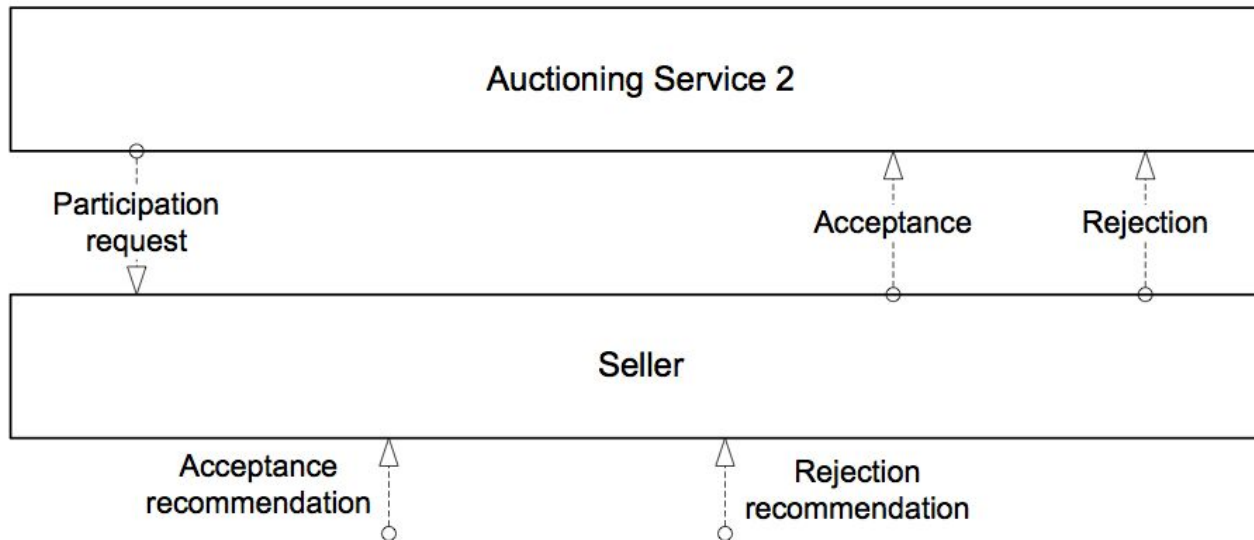

Fig. 5.9. Behavioural interface for seller



M. Weske: Business Process Management,
© Springer-Verlag Berlin Heidelberg 2012, 2007

Fig. 5.10. Interactions of participants in auctioning scenario



M. Weske: Business Process Management,
© Springer-Verlag Berlin Heidelberg 2012, 2007

Fig. 5.11. Alternative auctioning service results in weak structural compatibility

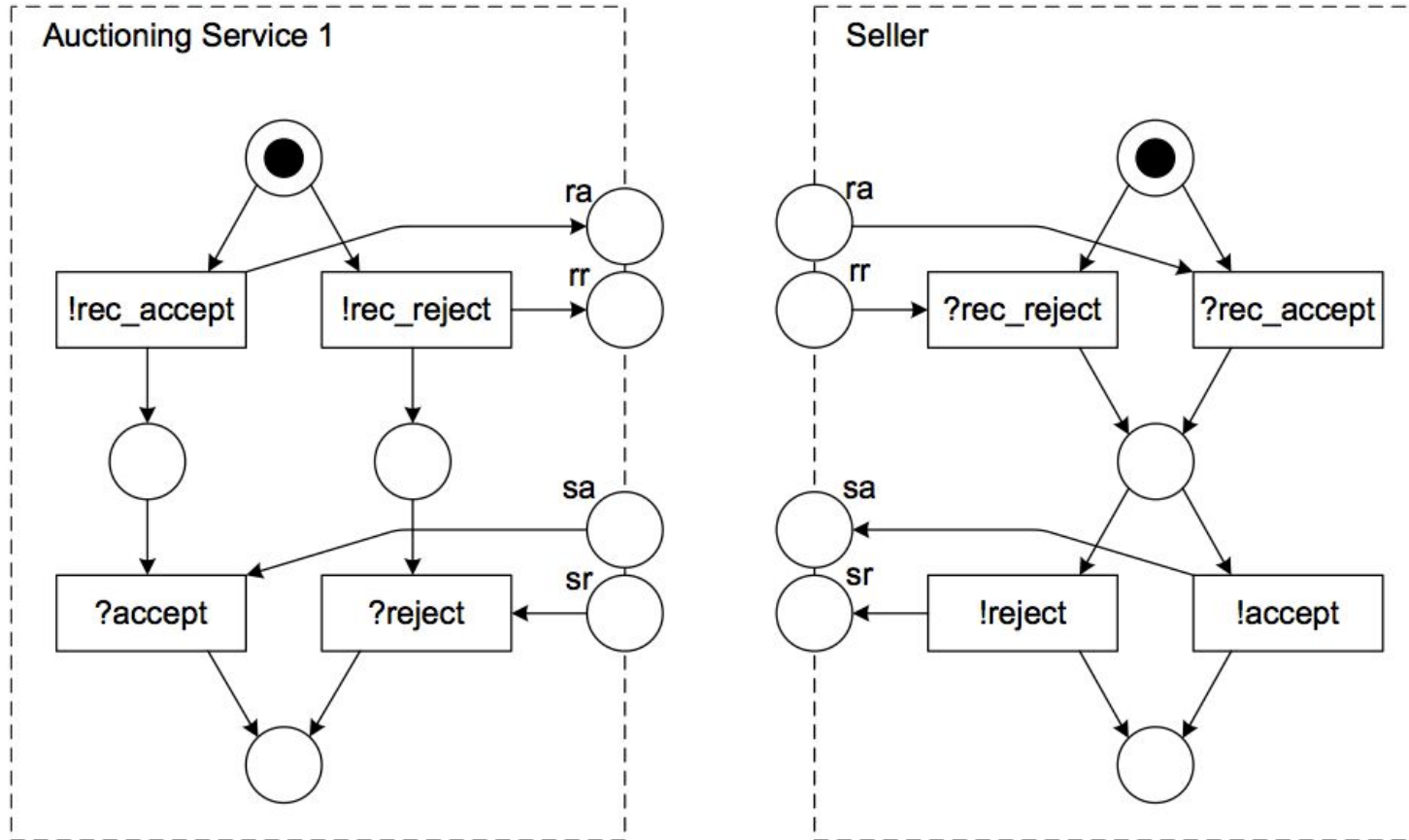
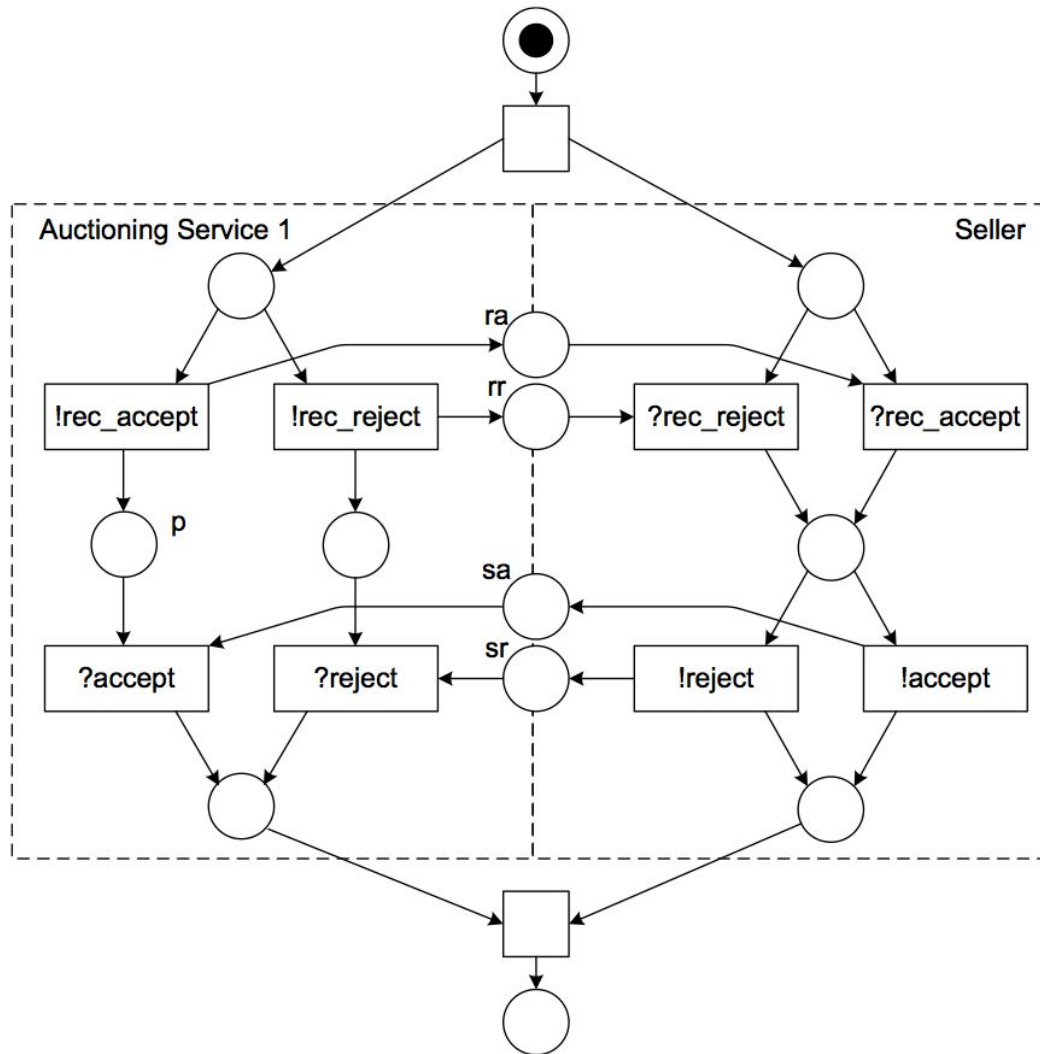
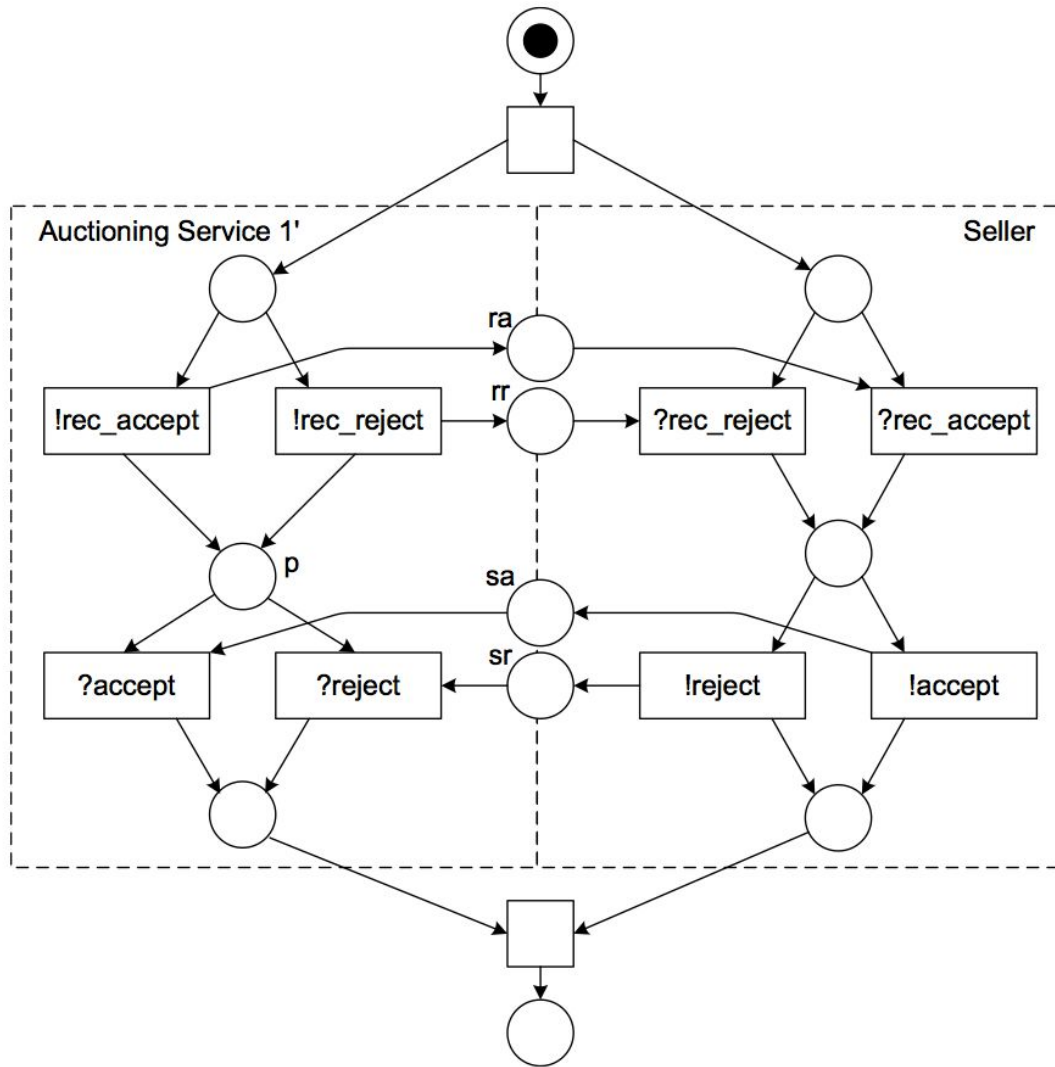

Fig. 5.12. Workflow modules as basis for checking compatibility



M. Weske: Business Process Management,
© Springer-Verlag Berlin Heidelberg 2012, 2007

Fig. 5.13. Workflow net as composition of workflow modules



M. Weske: Business Process Management,
© Springer-Verlag Berlin Heidelberg 2012, 2007

Fig. 5.14. Workflow modules that are compatible

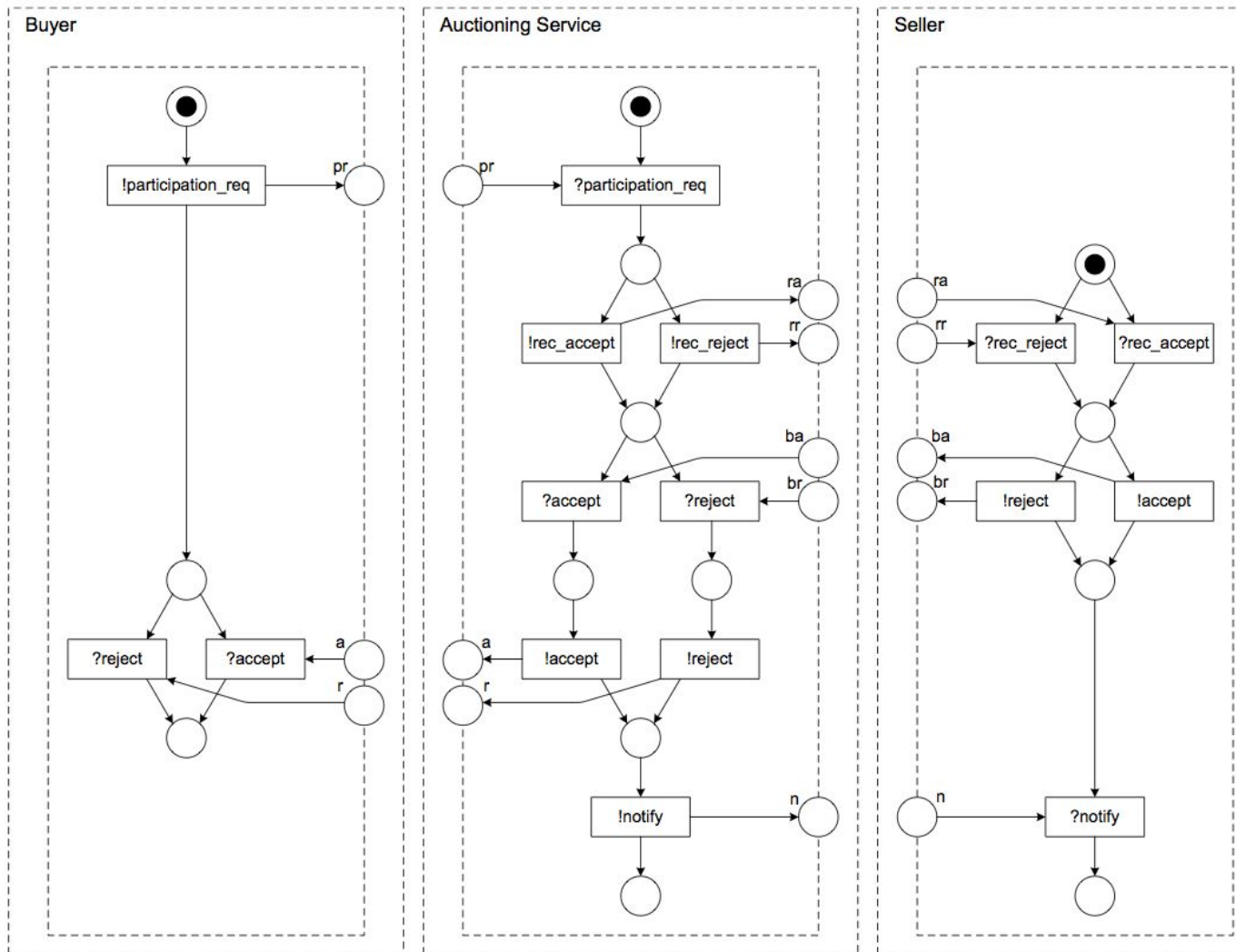
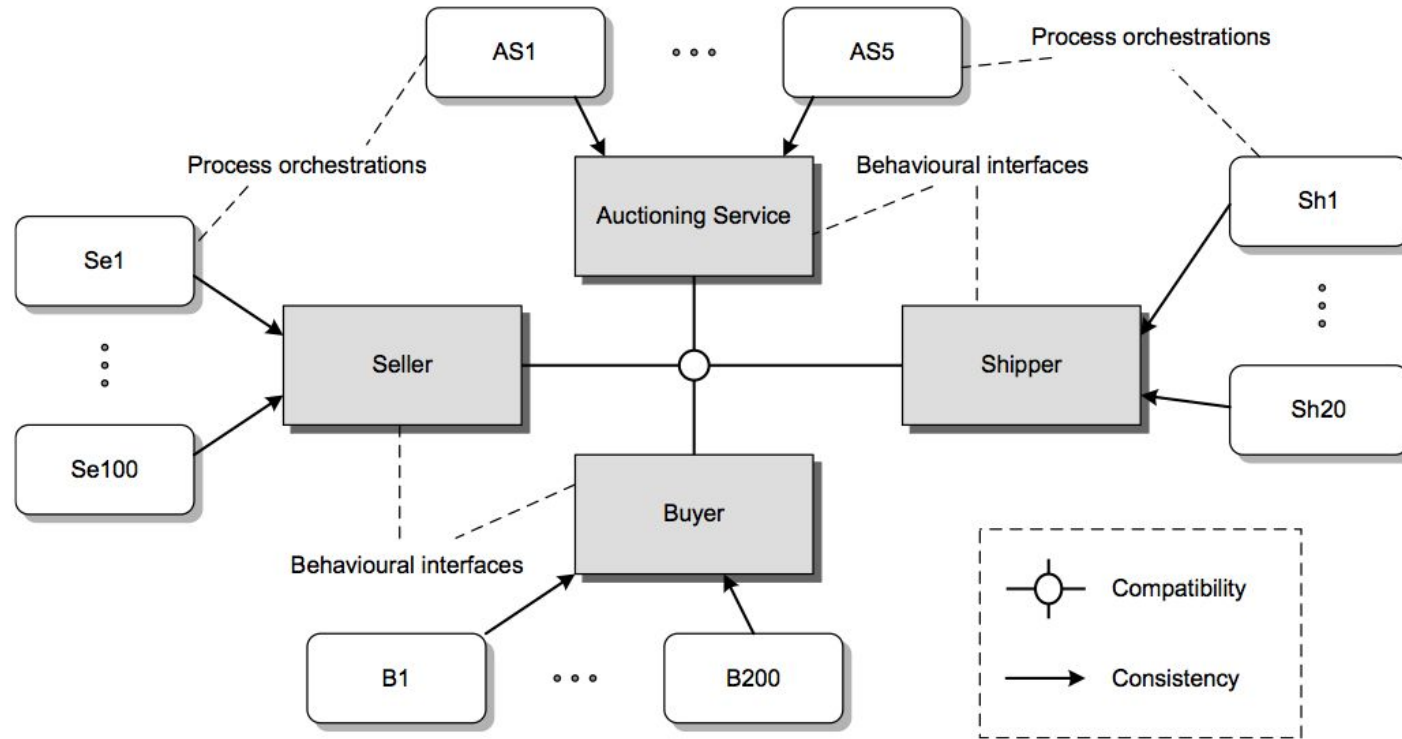

Fig. 5.15. Behavioural interfaces: getting a participation permission

M. Weske: Business Process Management,
© Springer-Verlag Berlin Heidelberg 2012, 2007



M. Weske: Business Process Management,
© Springer-Verlag Berlin Heidelberg 2012, 2007

Fig. 5.16. Participants roles with compatibility and consistency relations in a reverse auctioning scenario

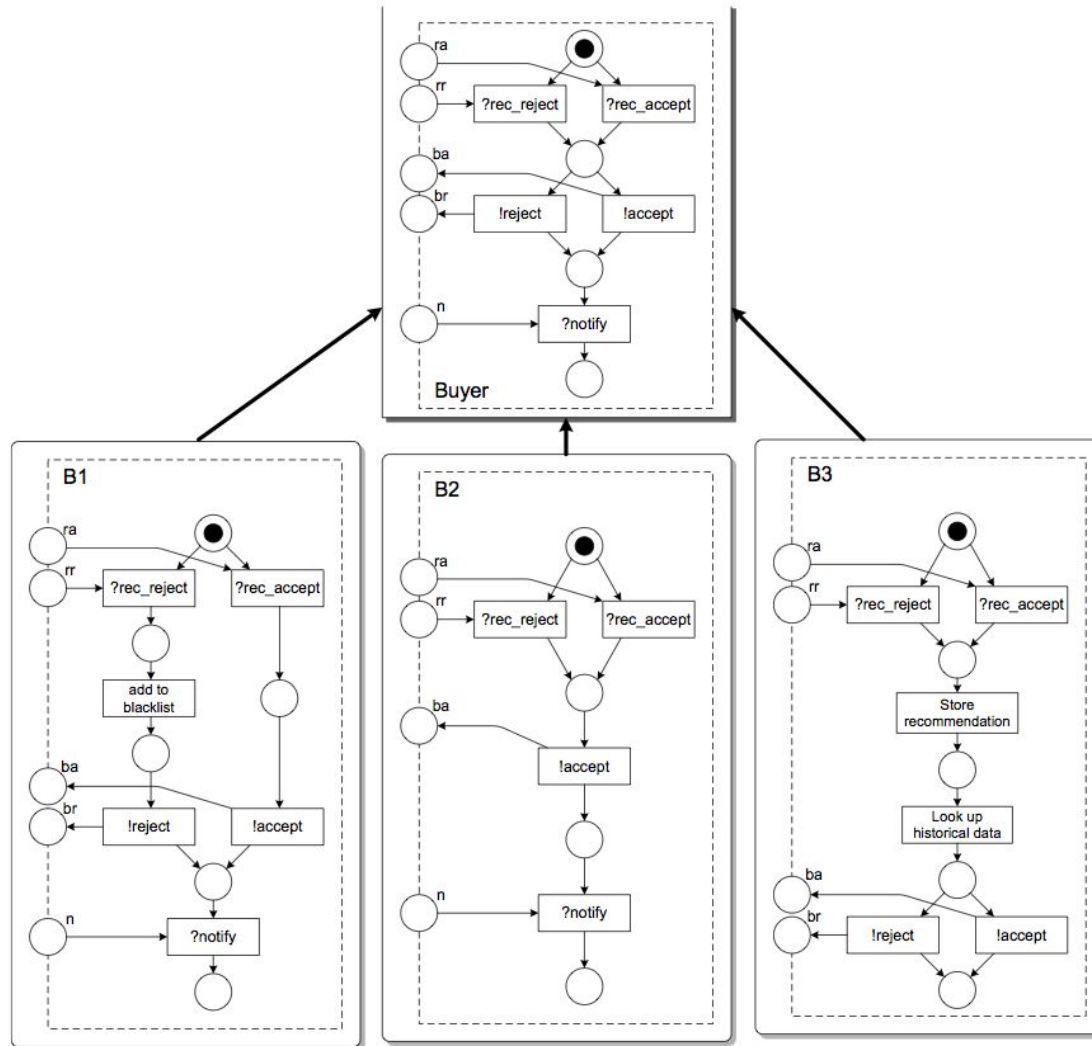

Fig. 5.17. Alternative implementations for buyer role

M. Weske: Business Process Management,
© Springer-Verlag Berlin Heidelberg 2012, 2007

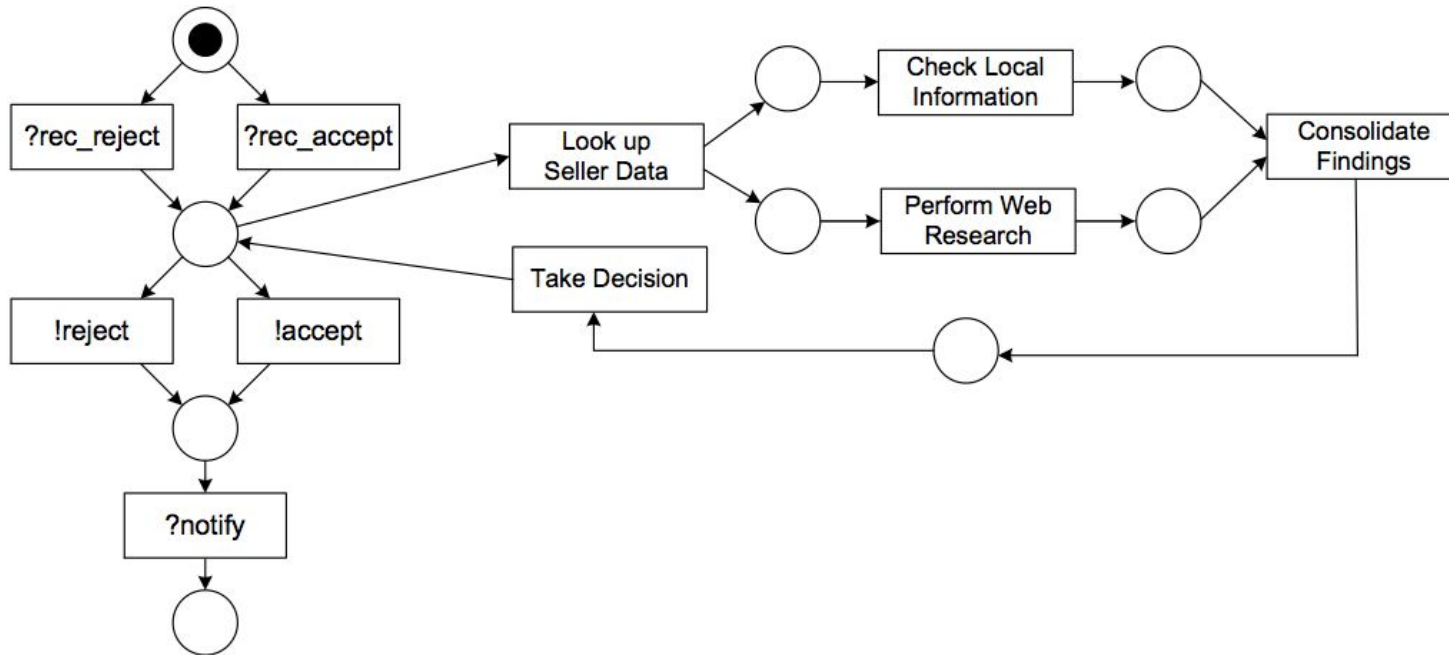
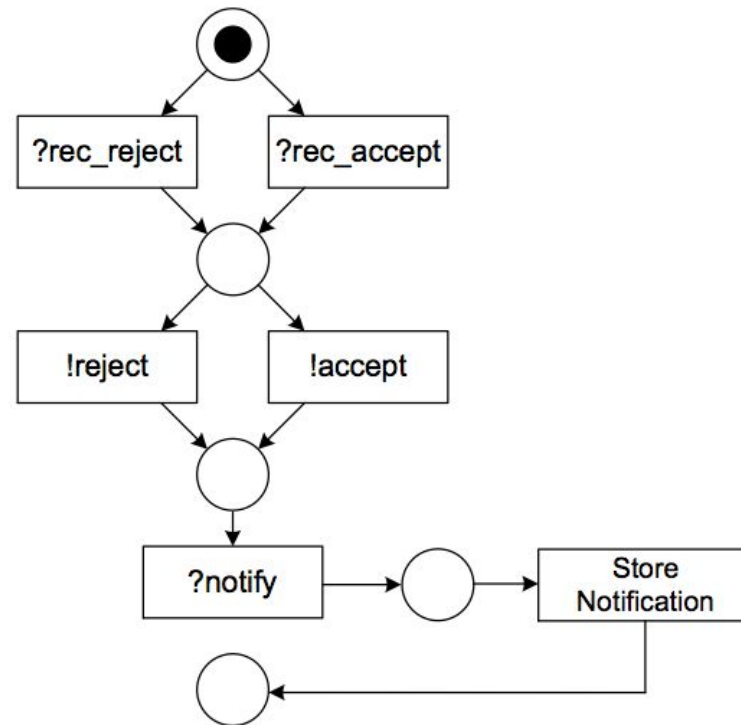

Fig. 5.18. Loop transformation operation of the public-to-private approach

M. Weske: Business Process Management,
© Springer-Verlag Berlin Heidelberg 2012, 2007



M. Weske: Business Process Management,
© Springer-Verlag Berlin Heidelberg 2012, 2007

Fig. 5.19. *Detour* transformation operation of the public-to-private approach

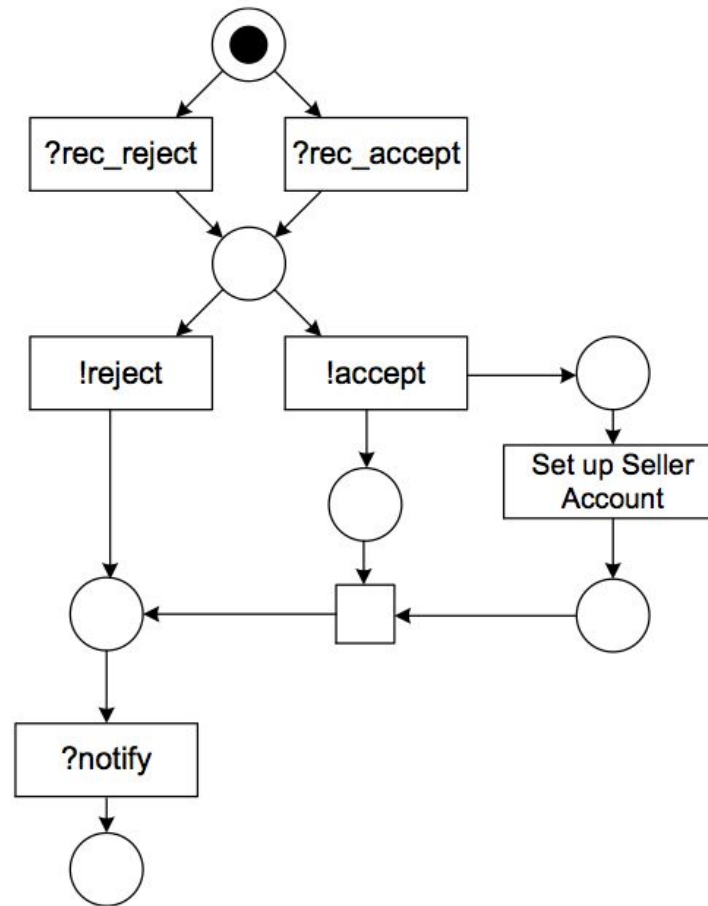

M. Weske: Business Process Management,
© Springer-Verlag Berlin Heidelberg 2012, 2007

Fig. 5.20. *Concur* transformation operation of the public-to-private approach

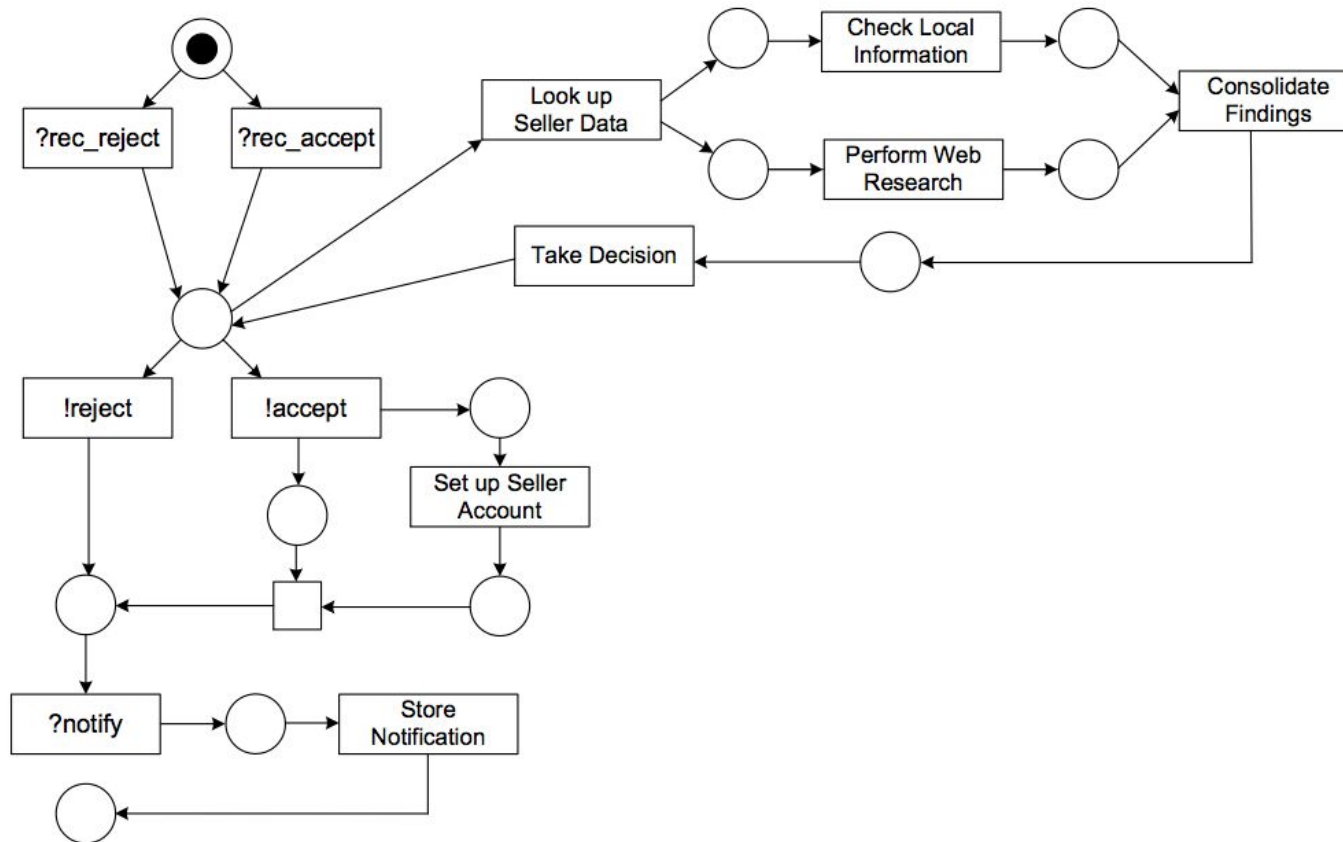

M. Weske: Business Process Management,
 © Springer-Verlag Berlin Heidelberg 2012, 2007

Fig. 5.21. Private process that—according to the public-to-private approach—is consistent with the public process of the buyer

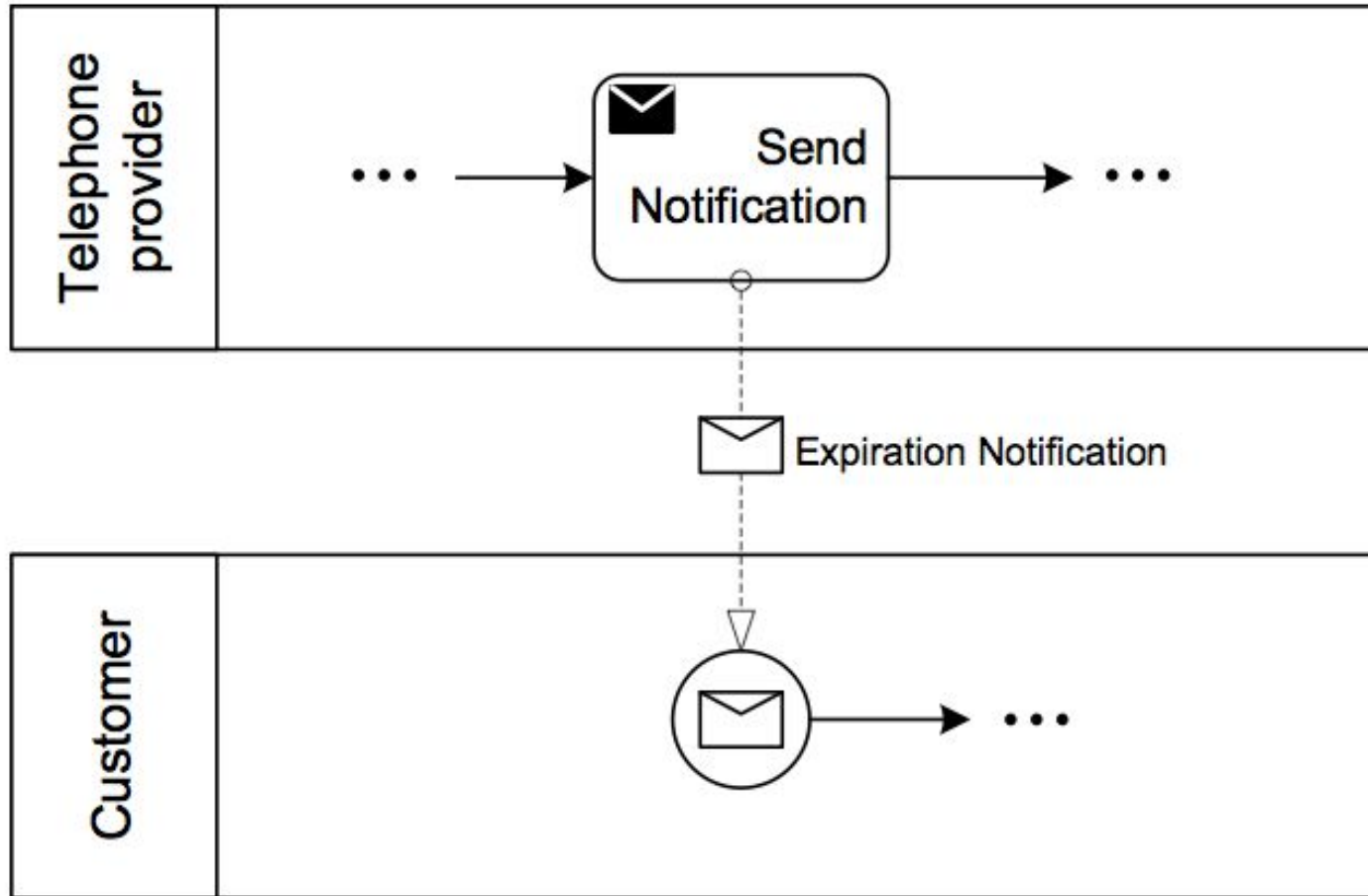

Fig. 5.22. Send pattern

M. Weske: Business Process Management,
© Springer-Verlag Berlin Heidelberg 2012, 2007

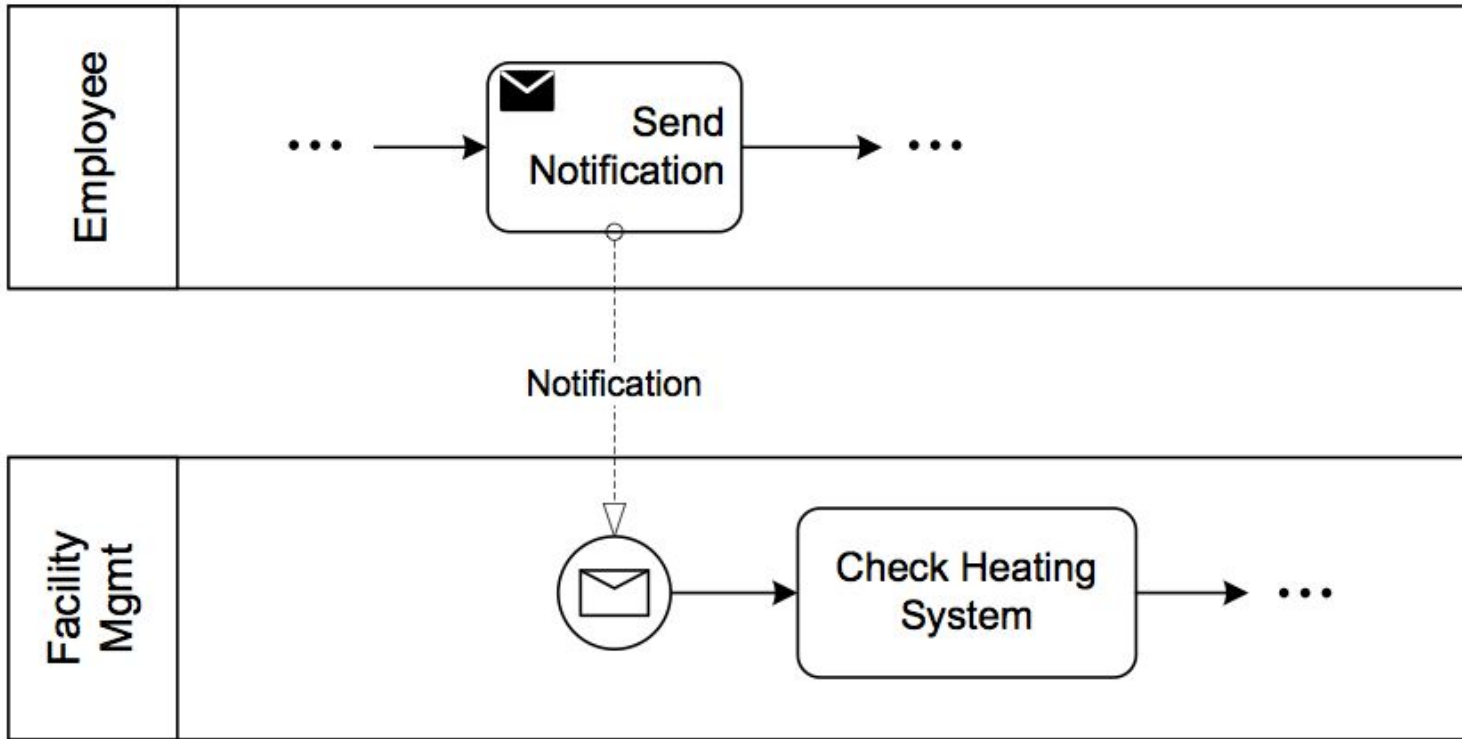

Fig. 5.23. Receive pattern

M. Weske: Business Process Management,
© Springer-Verlag Berlin Heidelberg 2012, 2007

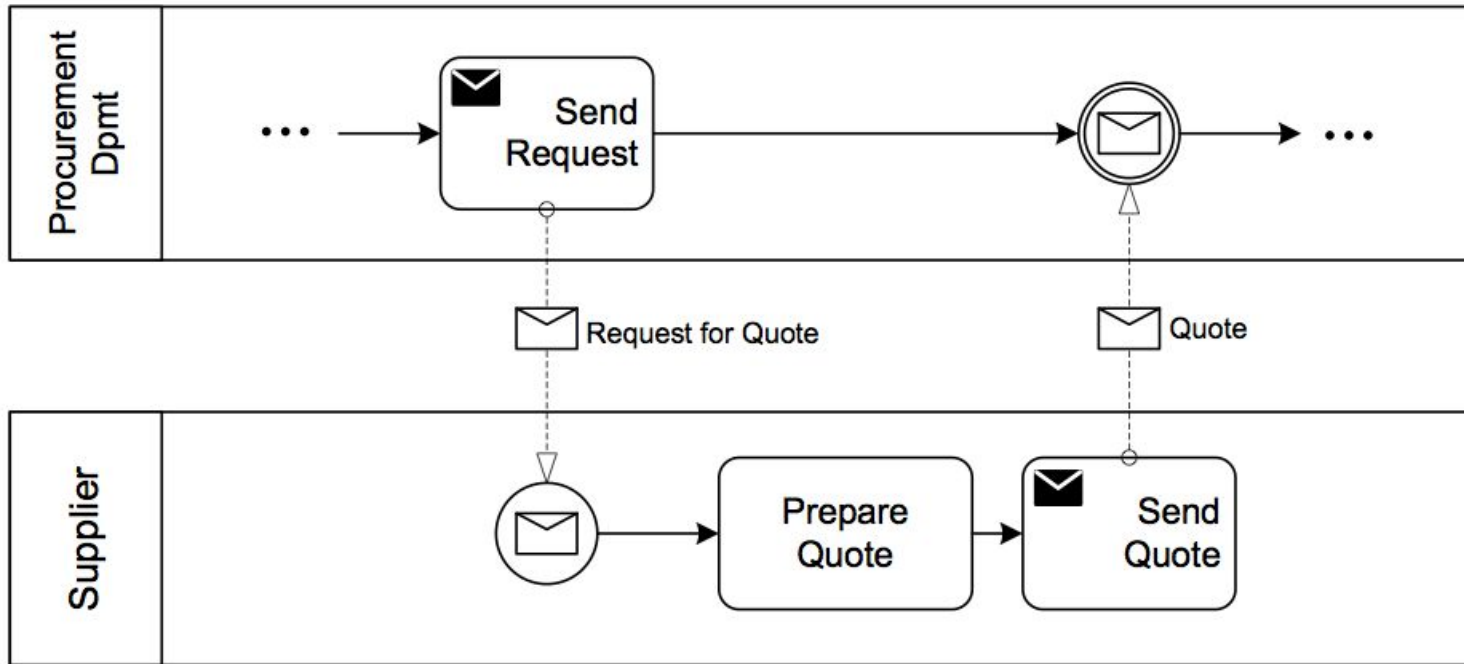
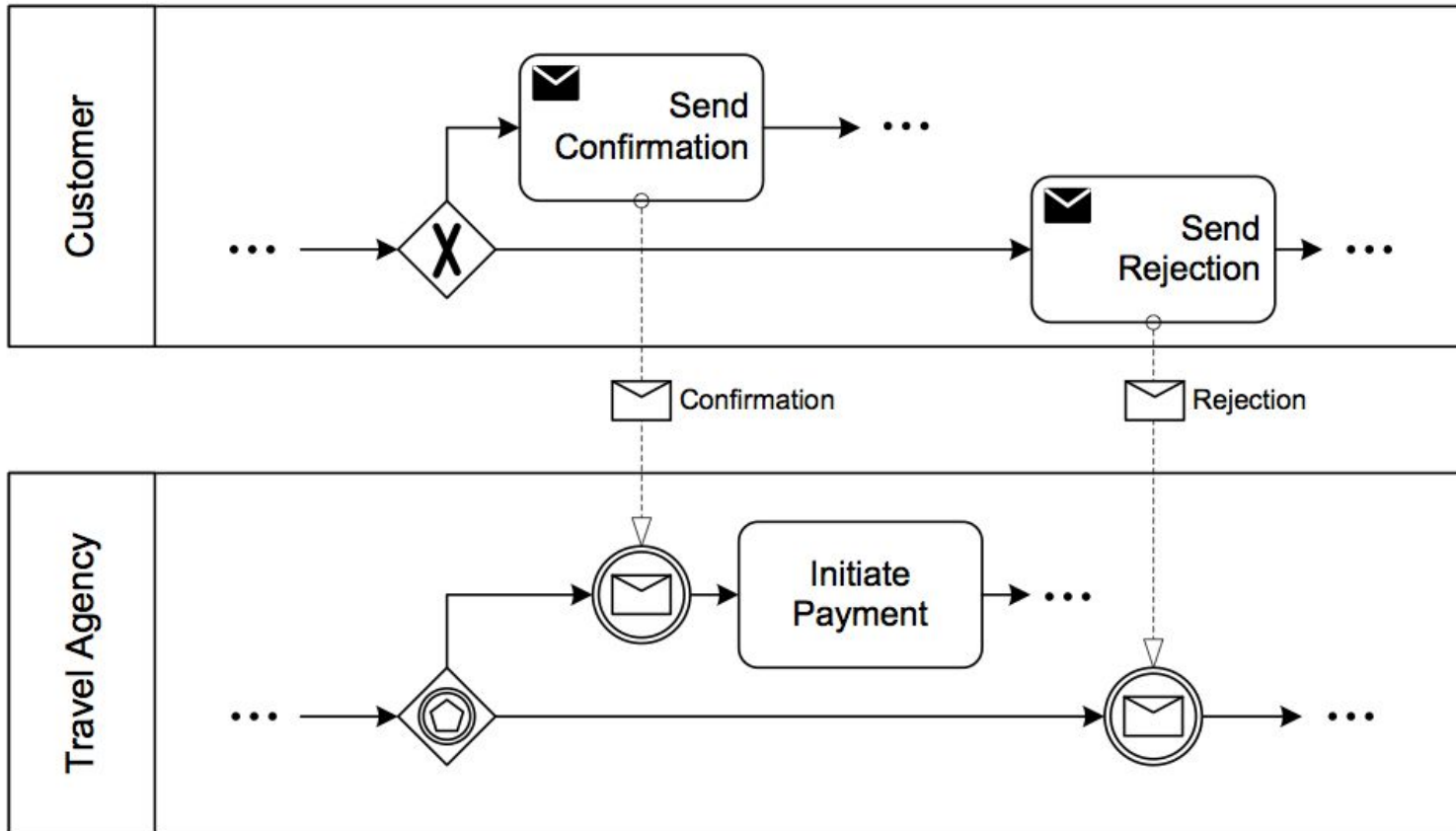

Fig. 5.24. Send/receive pattern

M. Weske: Business Process Management,
© Springer-Verlag Berlin Heidelberg 2012, 2007



M. Weske: Business Process Management,
© Springer-Verlag Berlin Heidelberg 2012, 2007

Fig. 5.25. Racing incoming messages pattern

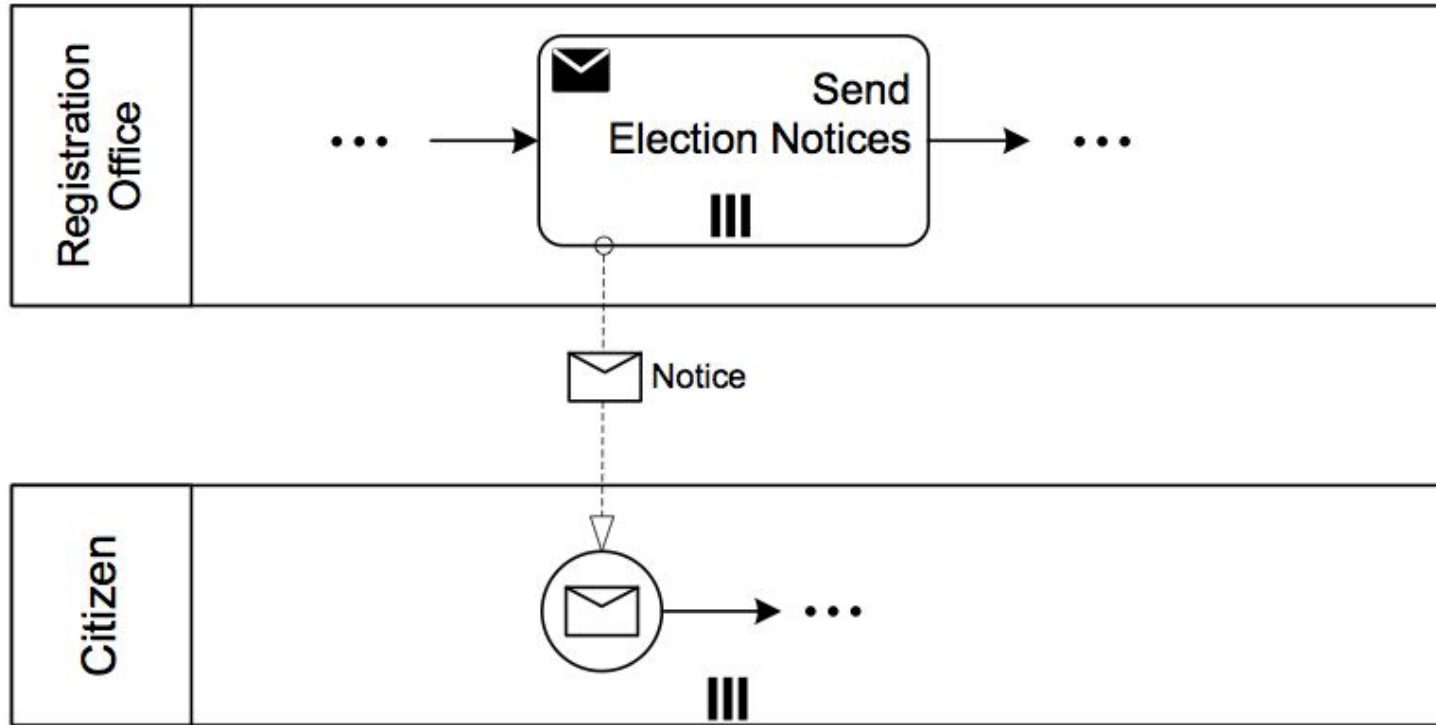
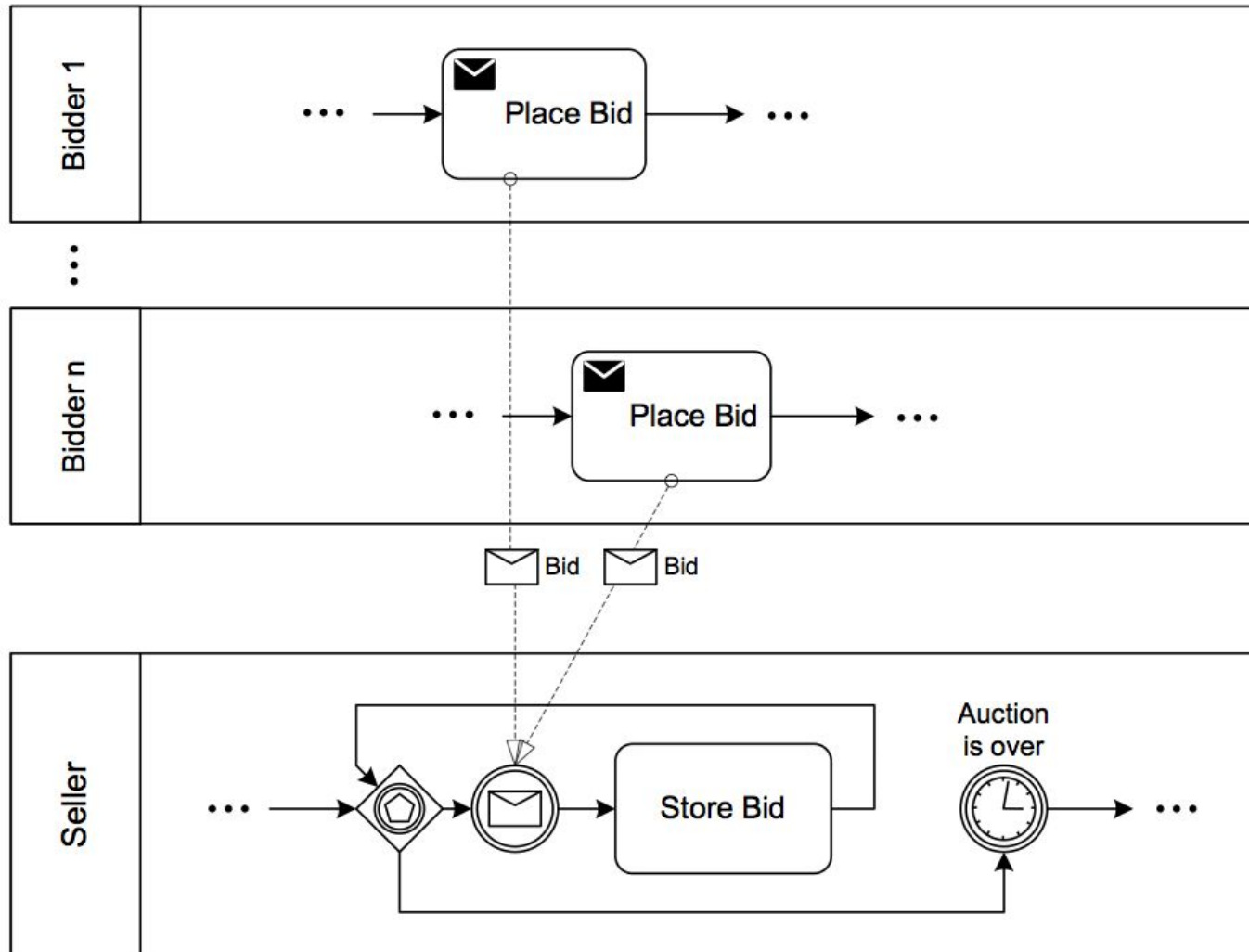

Fig. 5.26. One-to-many send pattern

M. Weske: Business Process Management,
 © Springer-Verlag Berlin Heidelberg 2012, 2007



M. Weske: Business Process Management,
© Springer-Verlag Berlin Heidelberg 2012, 2007

Fig. 5.27. One-from-many receive pattern

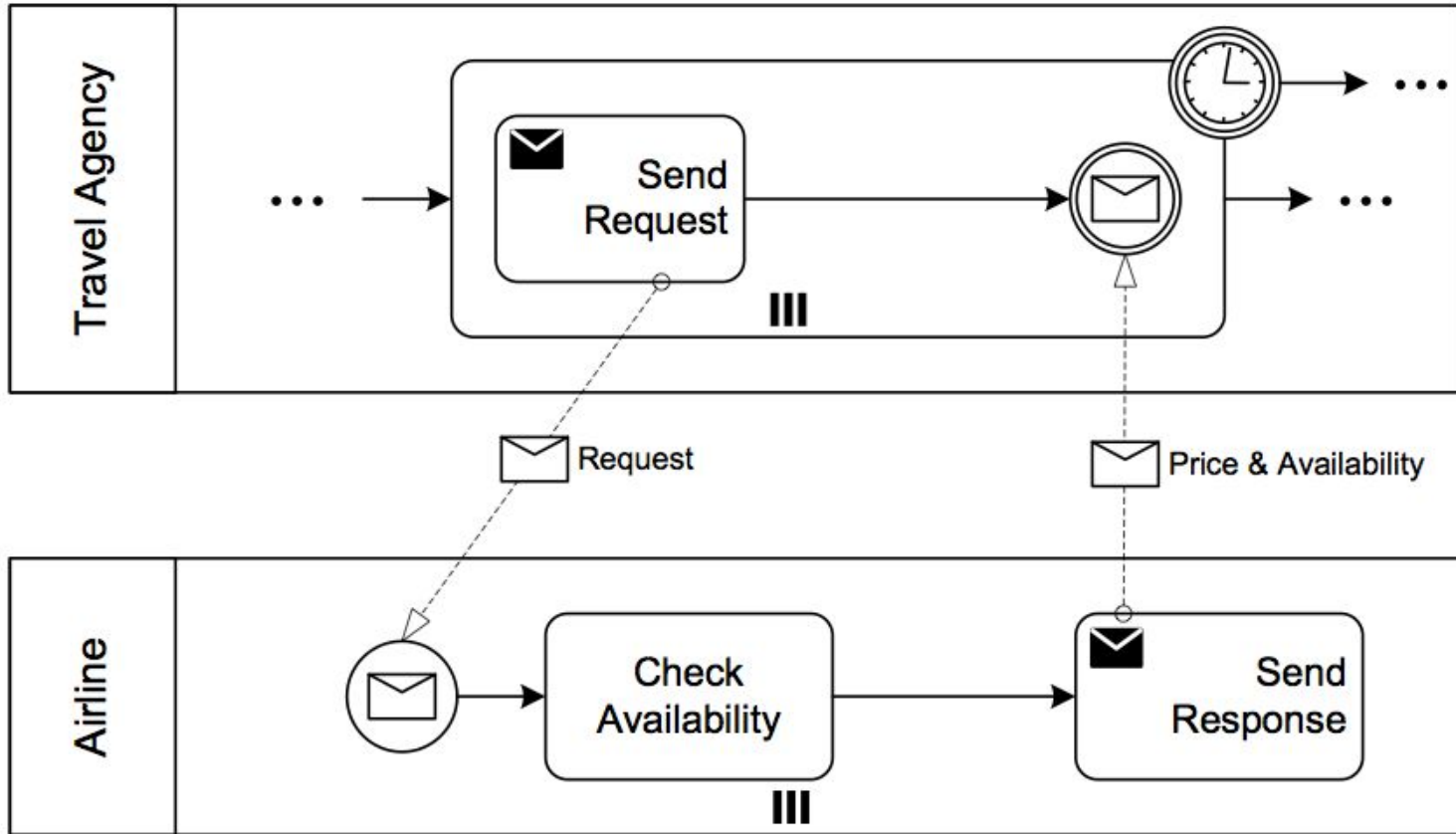

M. Weske: Business Process Management,
 © Springer-Verlag Berlin Heidelberg 2012, 2007

Fig. 5.28. One-to-many send/receive pattern

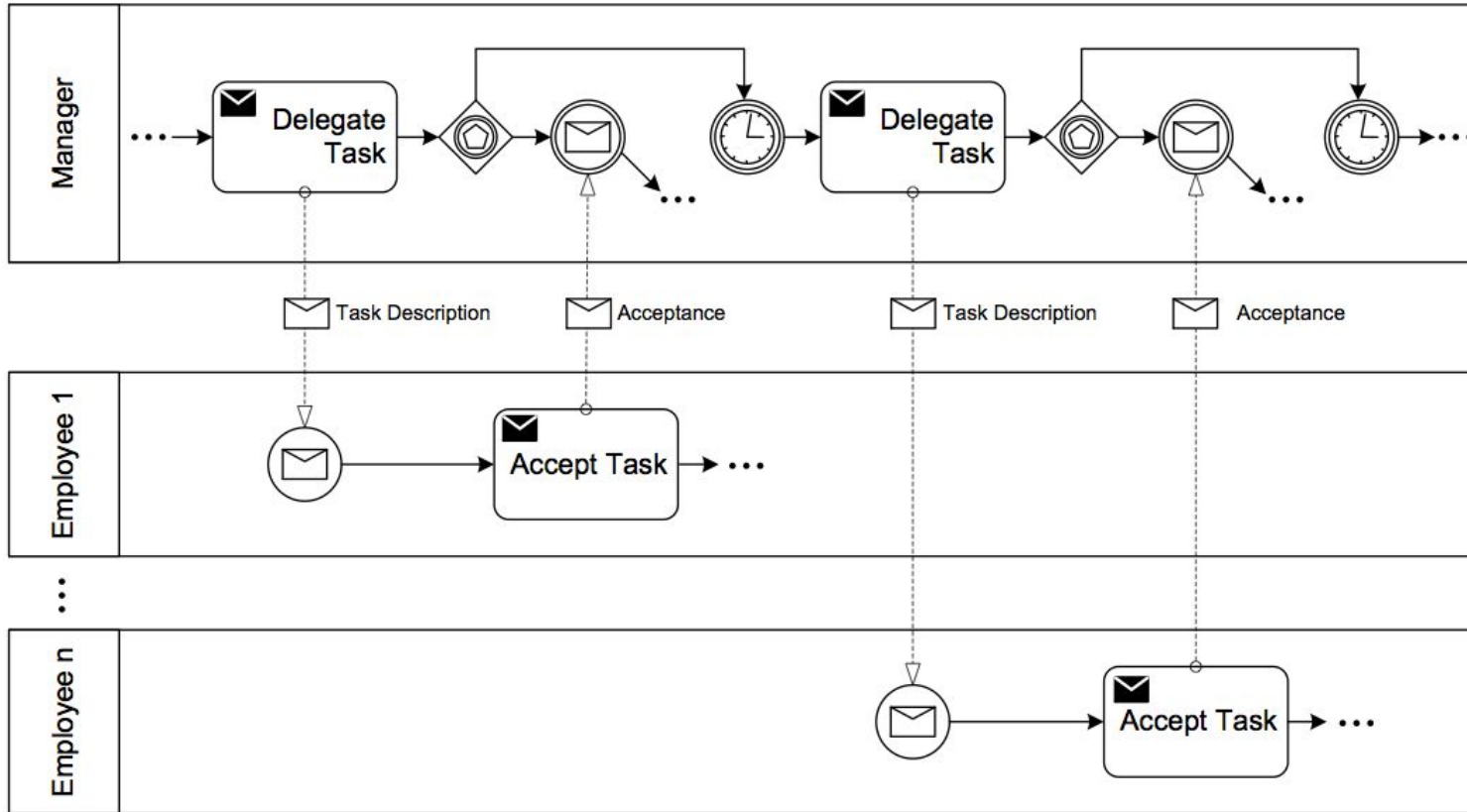

M. Weske: Business Process Management,
© Springer-Verlag Berlin Heidelberg 2012, 2007

Fig. 5.29. Contingent requests pattern

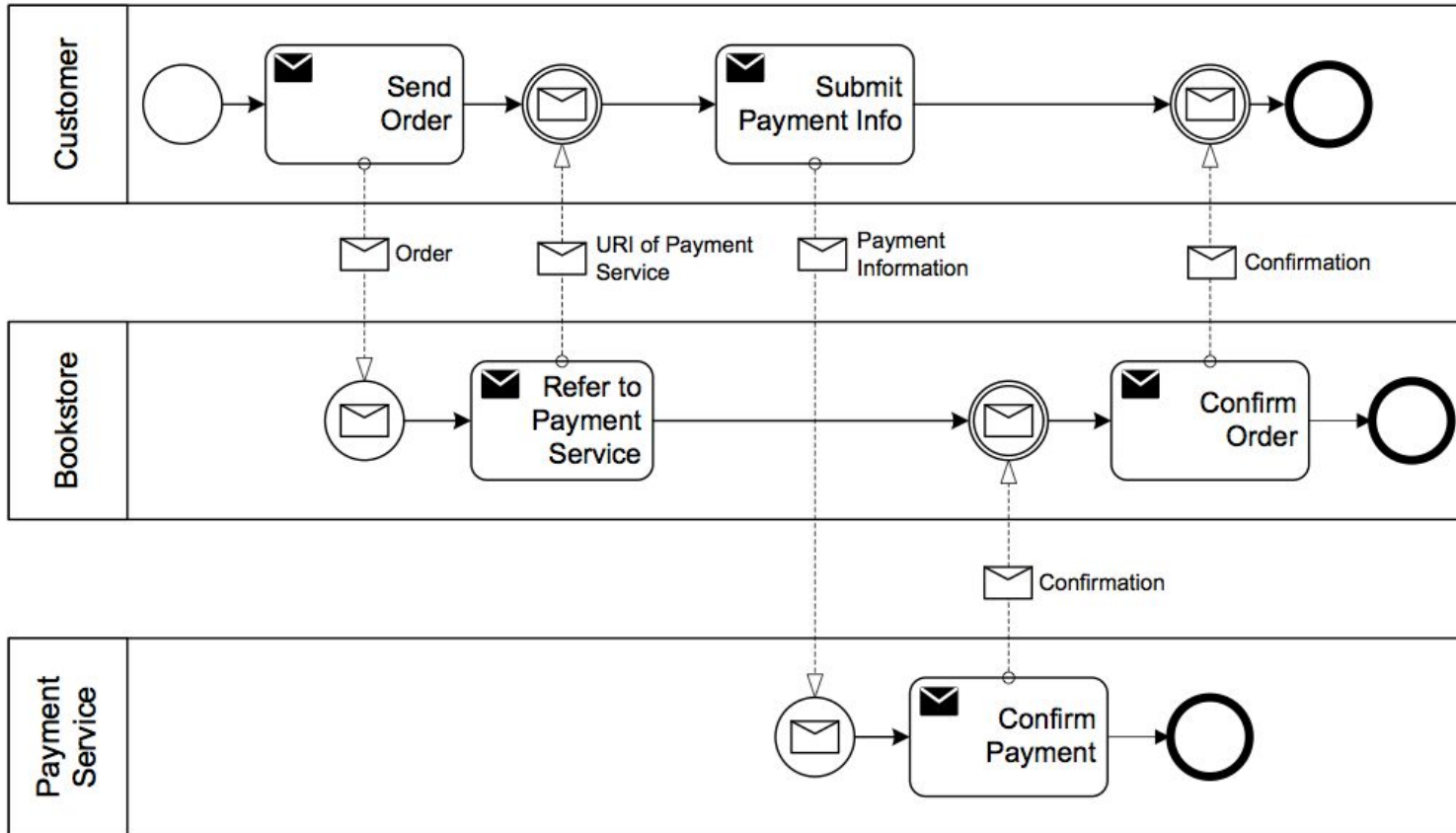

M. Weske: Business Process Management,
© Springer-Verlag Berlin Heidelberg 2012, 2007

Fig. 5.30. Example involving request with referral pattern

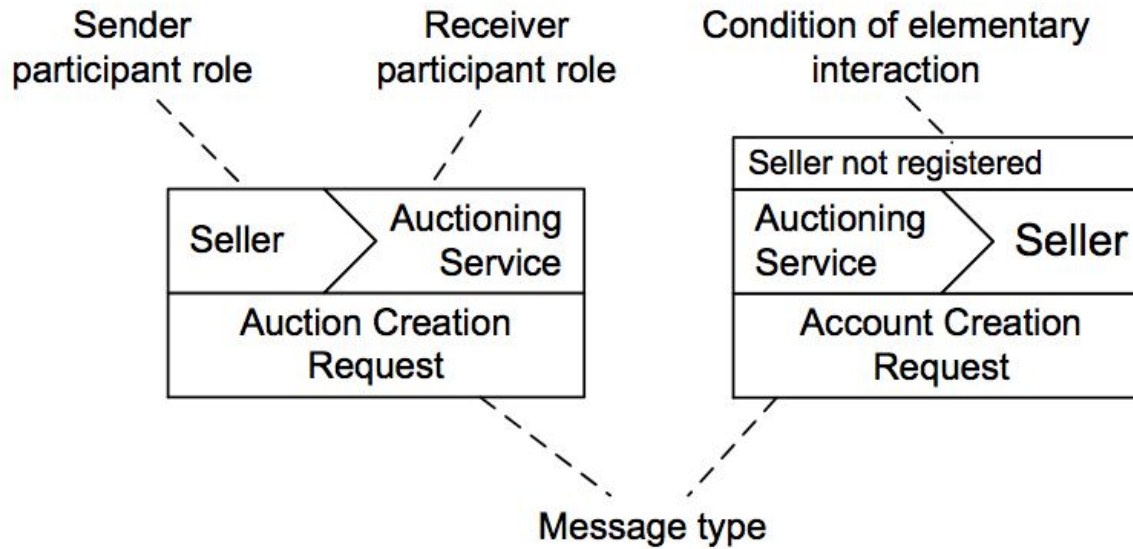
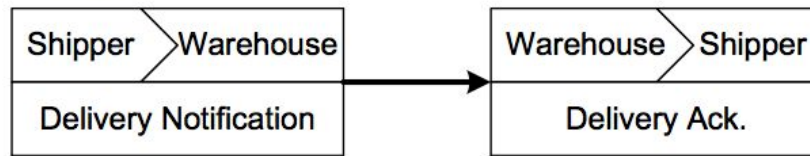
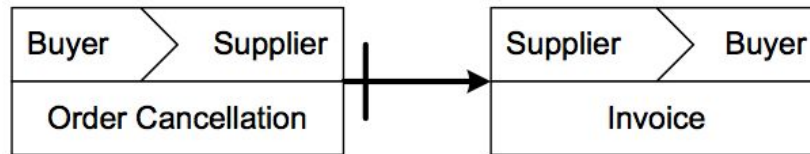

Fig. 5.31. Elementary interaction and conditional elementary interaction

Precedes



Inhibits



Vice-versa-Inhibits

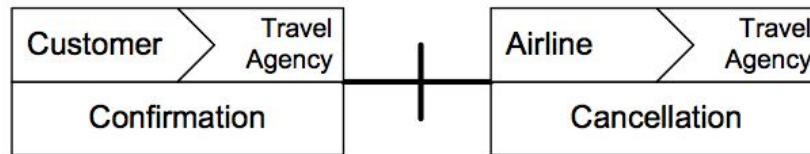

WeakPrecedes

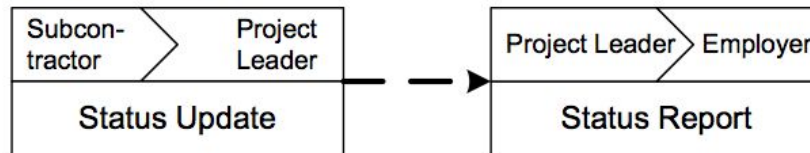

M. Weske: Business Process Management, © Springer-Verlag Berlin Heidelberg 2012, 2007

Fig. 5.32. Basic control flow structures relating interactions

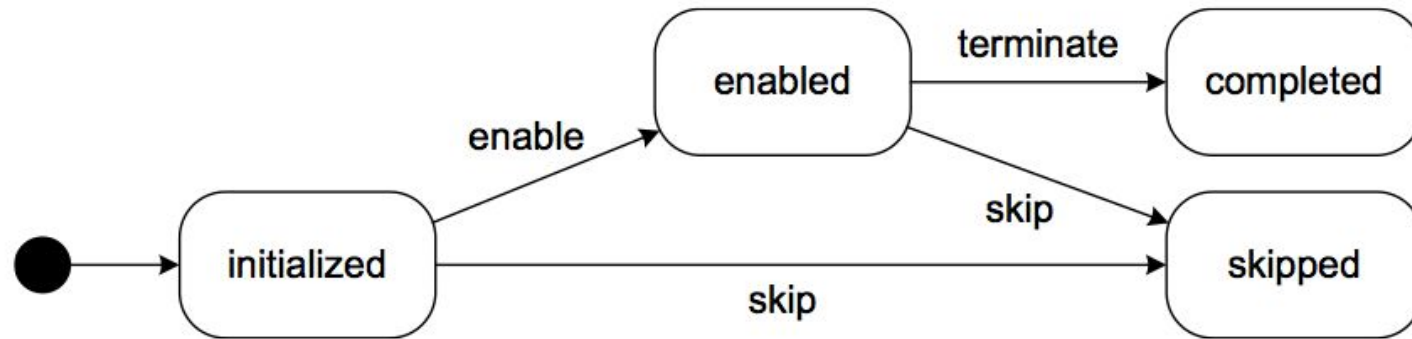

Fig. 5.33. Interaction instance lifecycle

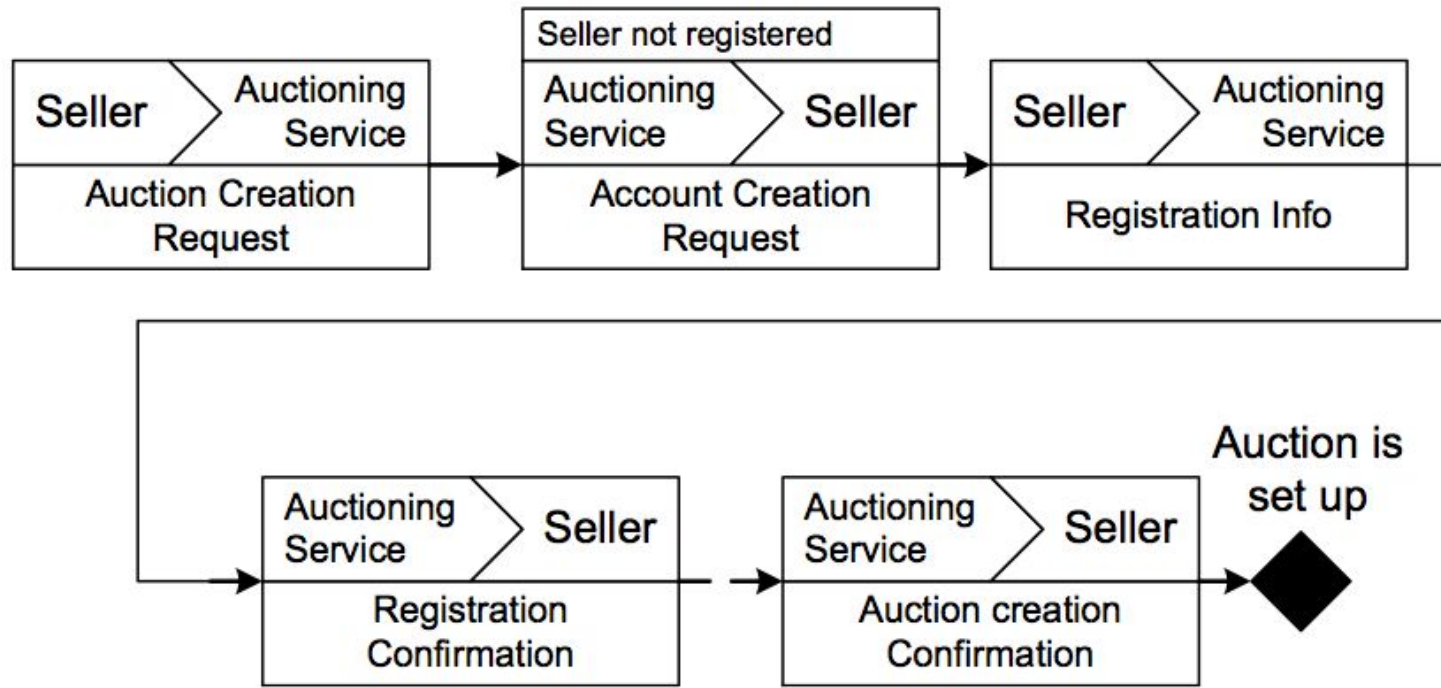
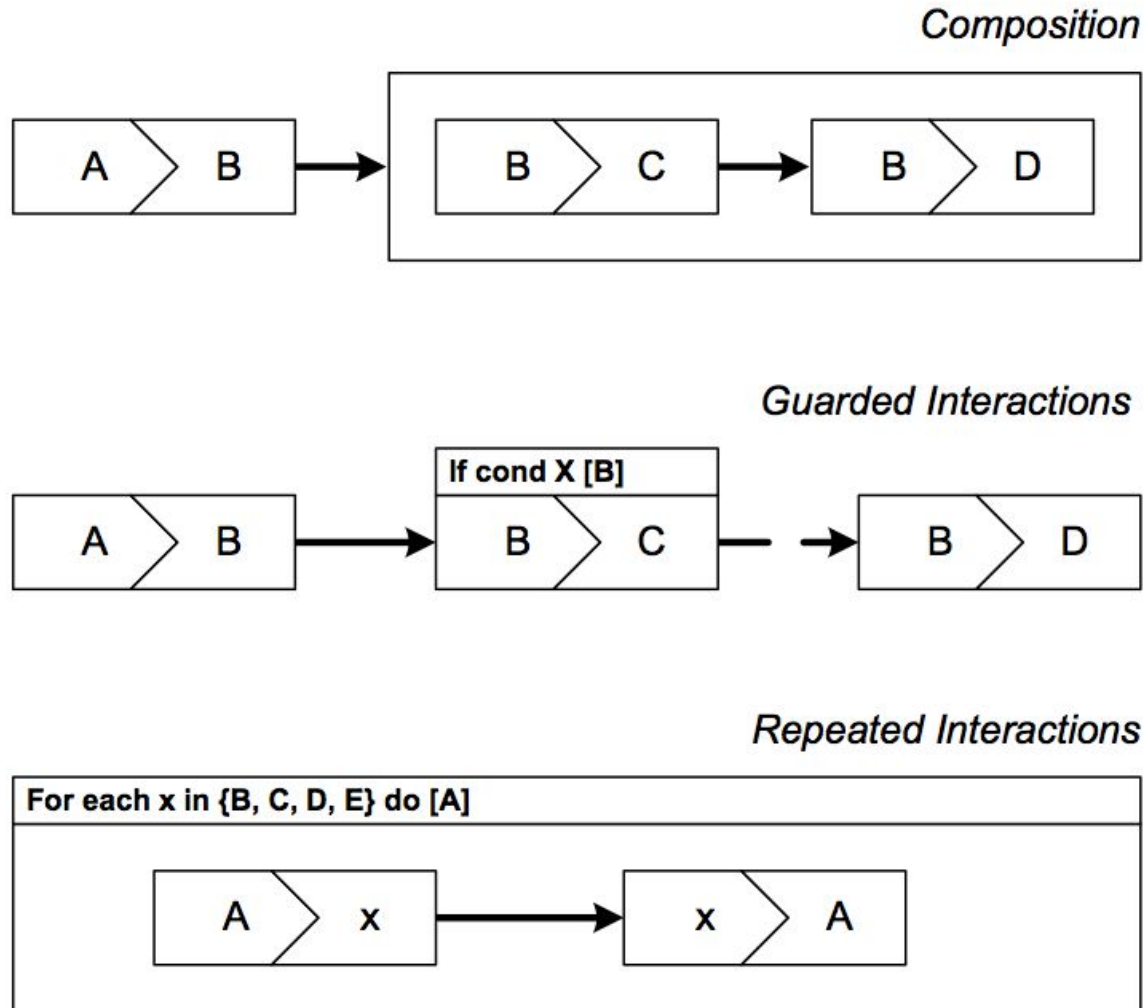

Fig. 5.34. Interaction modelling

M. Weske: Business Process Management,
© Springer-Verlag Berlin Heidelberg 2012, 2007



M. Weske: Business Process Management, © Springer-Verlag Berlin Heidelberg 2012, 2007

Fig. 5.35. Advanced control flow constructs

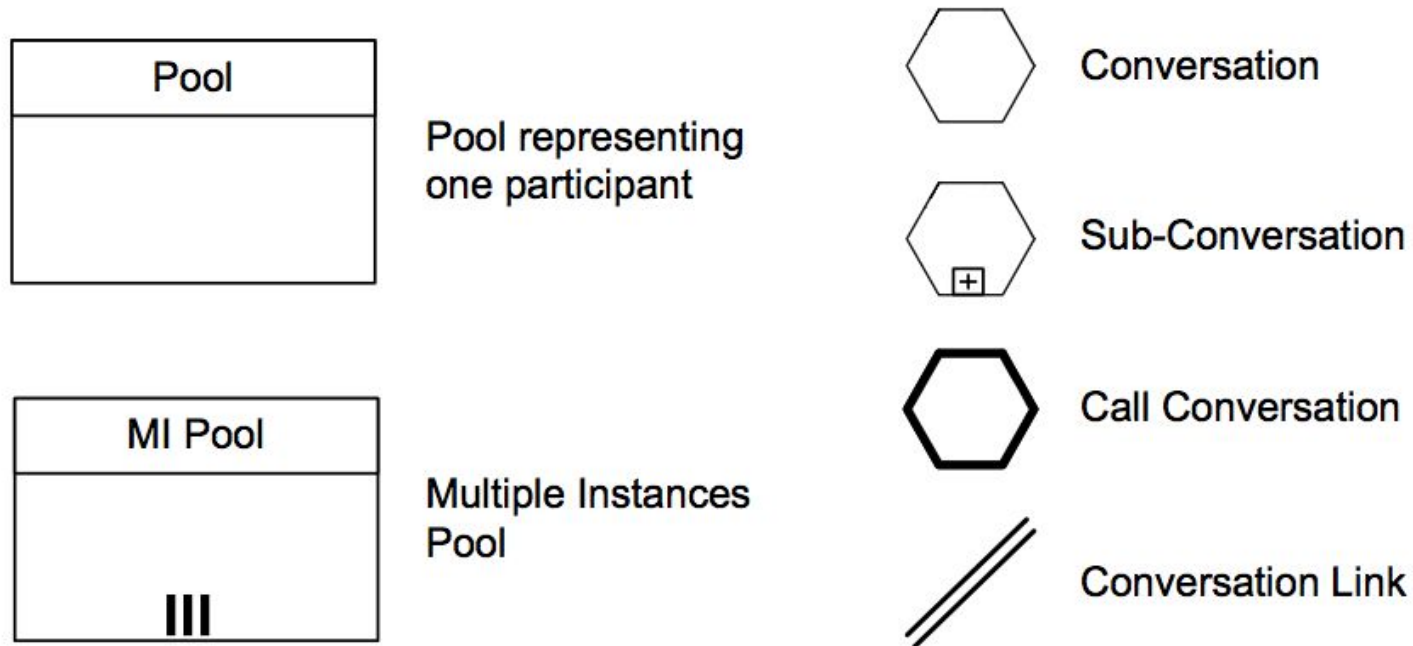

Fig. 5.36. Elements used in BPMN conversation diagrams

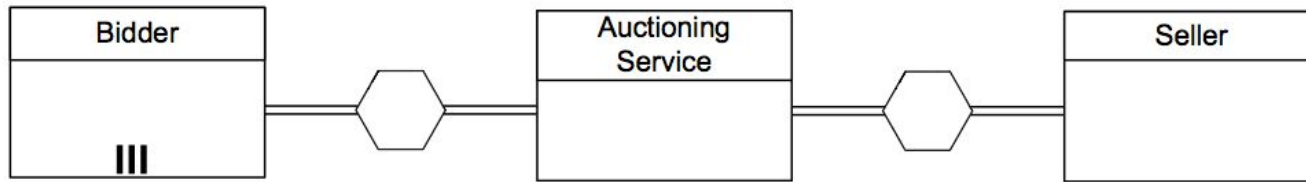
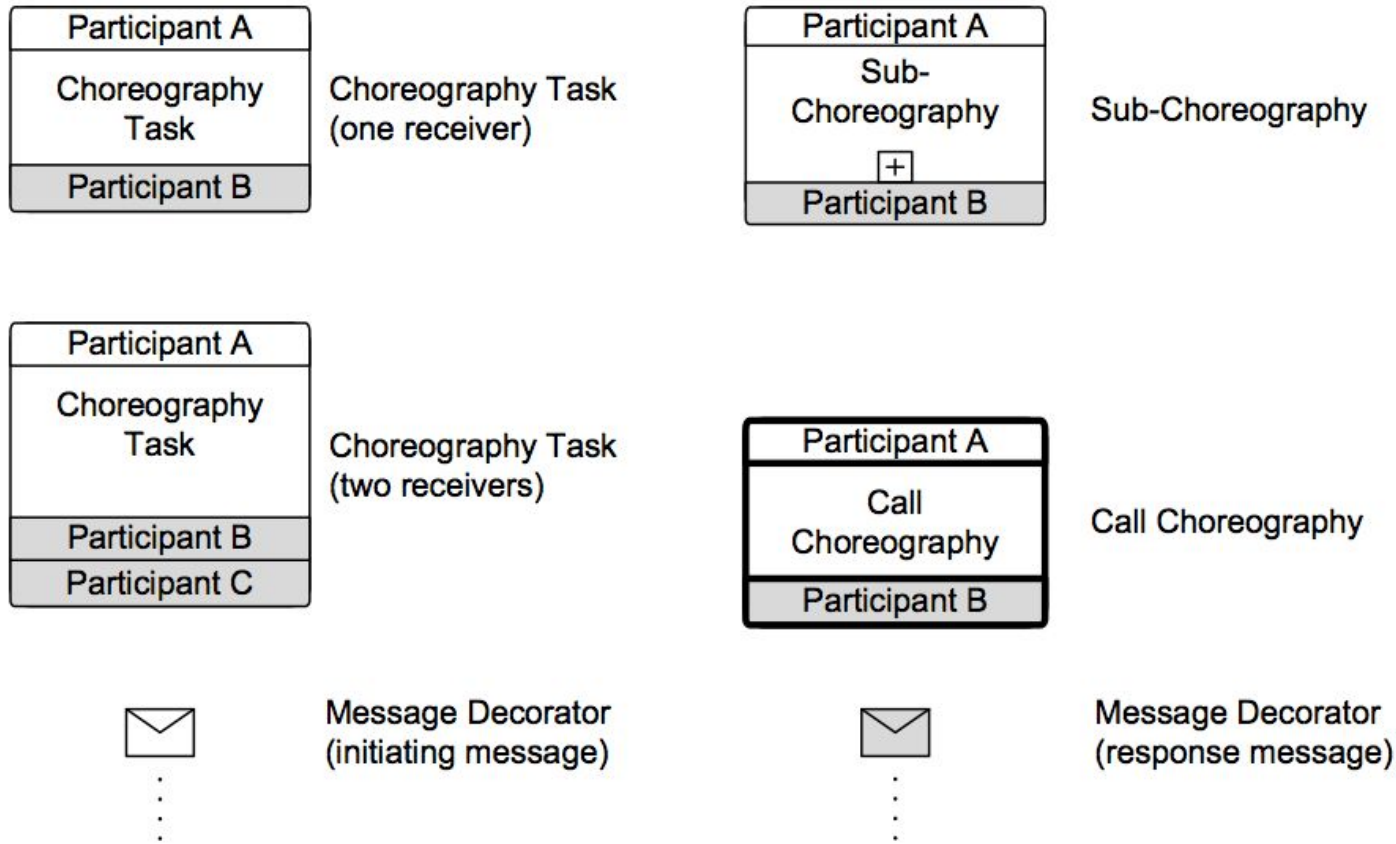
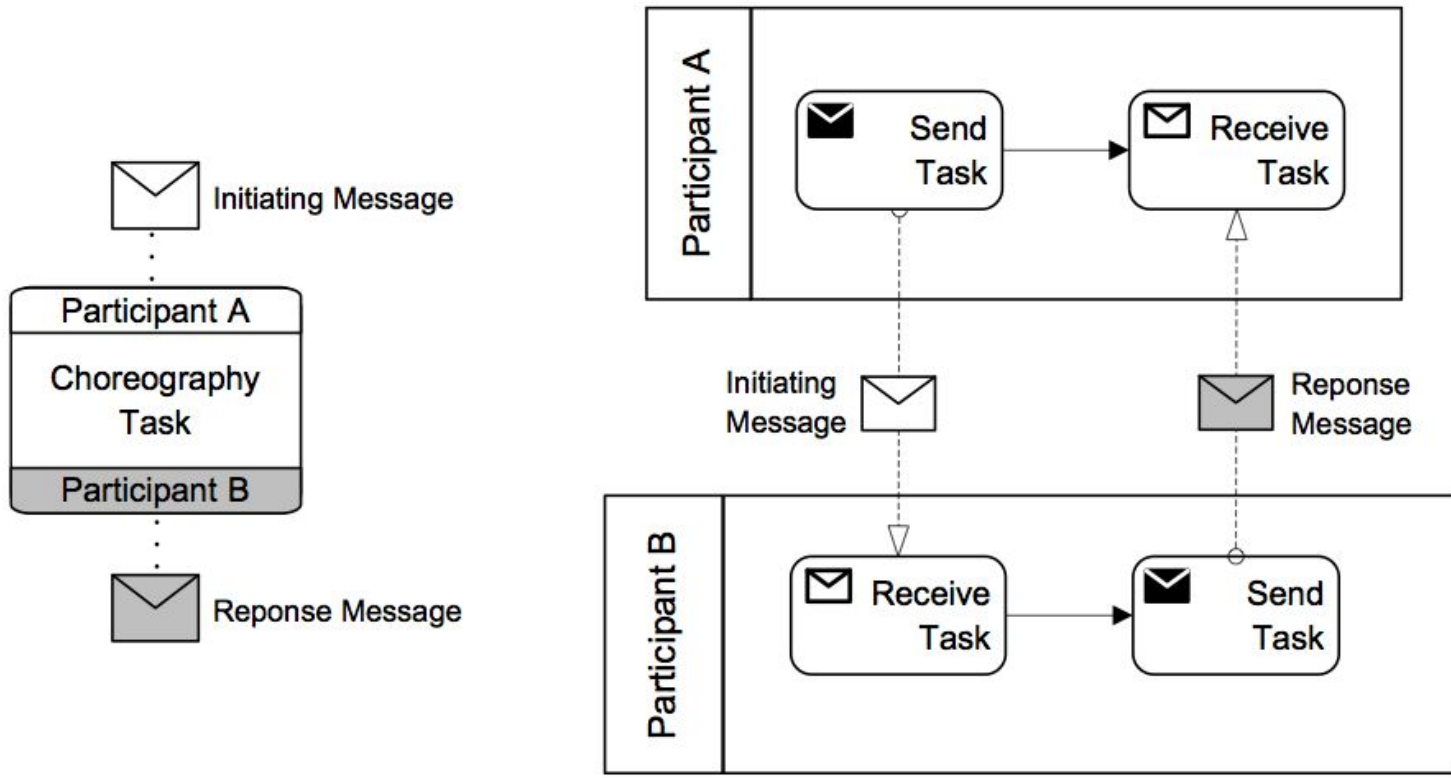

Fig. 5.37. Conversation diagram involving multiple bidders, an auctioning service, and a seller



M. Weske: Business Process Management, © Springer-Verlag Berlin Heidelberg 2012, 2007

Fig. 5.38. Notational elements used in BPMN Choreography diagrams



M. Weske: Business Process Management, © Springer-Verlag Berlin Heidelberg 2012, 2007

Fig. 5.39. Choreography task and corresponding process diagram

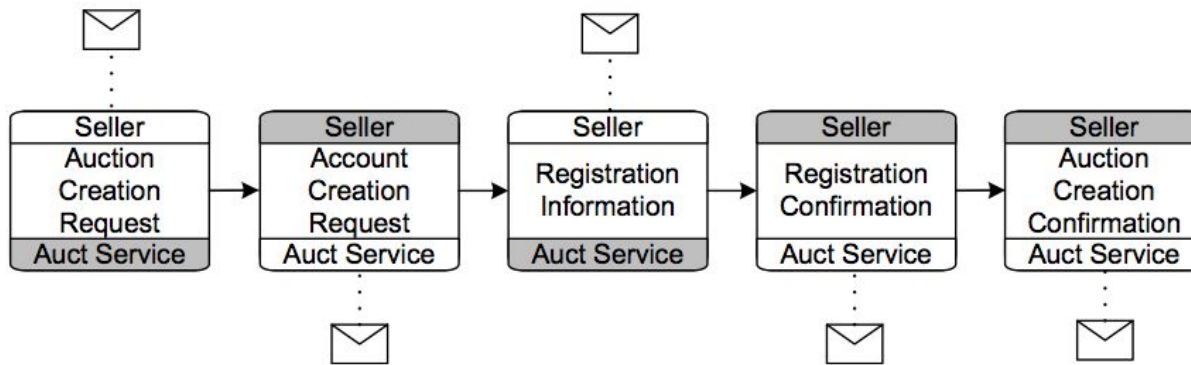
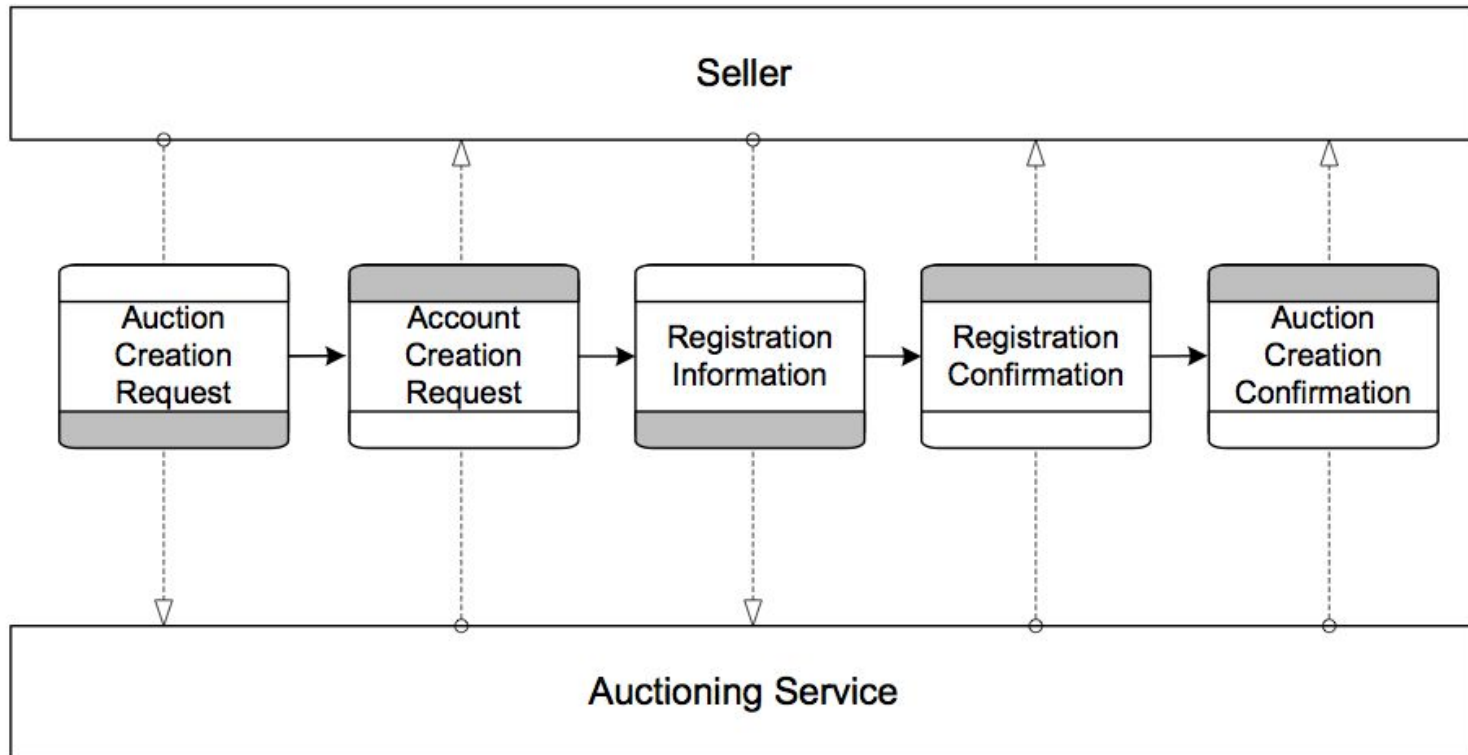

Fig. 5.40. Collaboration scenario, described by BPMN Choreography Diagrams



M. Weske: Business Process Management,
© Springer-Verlag Berlin Heidelberg 2012, 2007

Fig. 5.41. Choreography diagram with pools

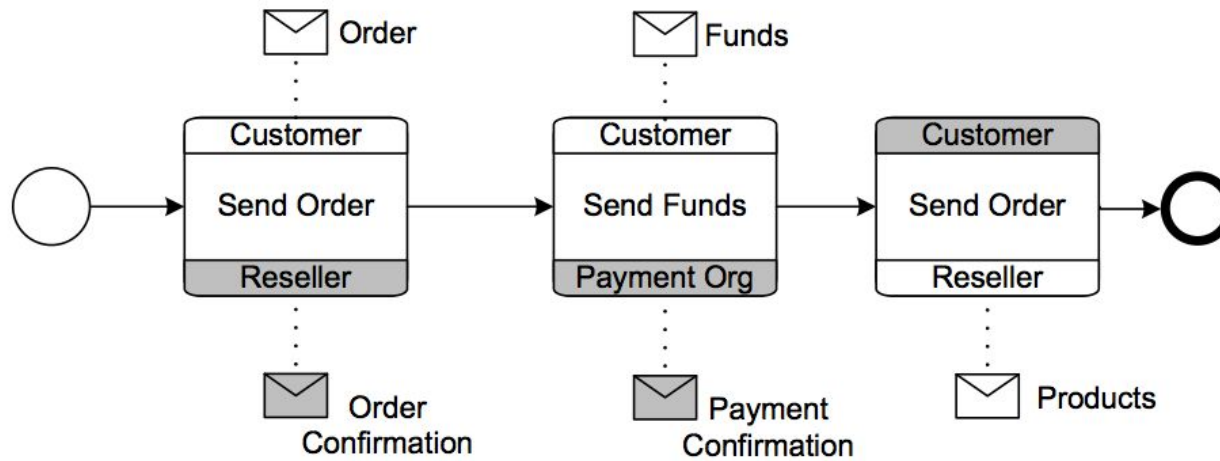

Fig. 5.42. Choreography diagram that is not enforceable, since the reseller cannot know if the customer has already send the funds

M. Weske: Business Process Management,
© Springer-Verlag Berlin Heidelberg 2012, 2007

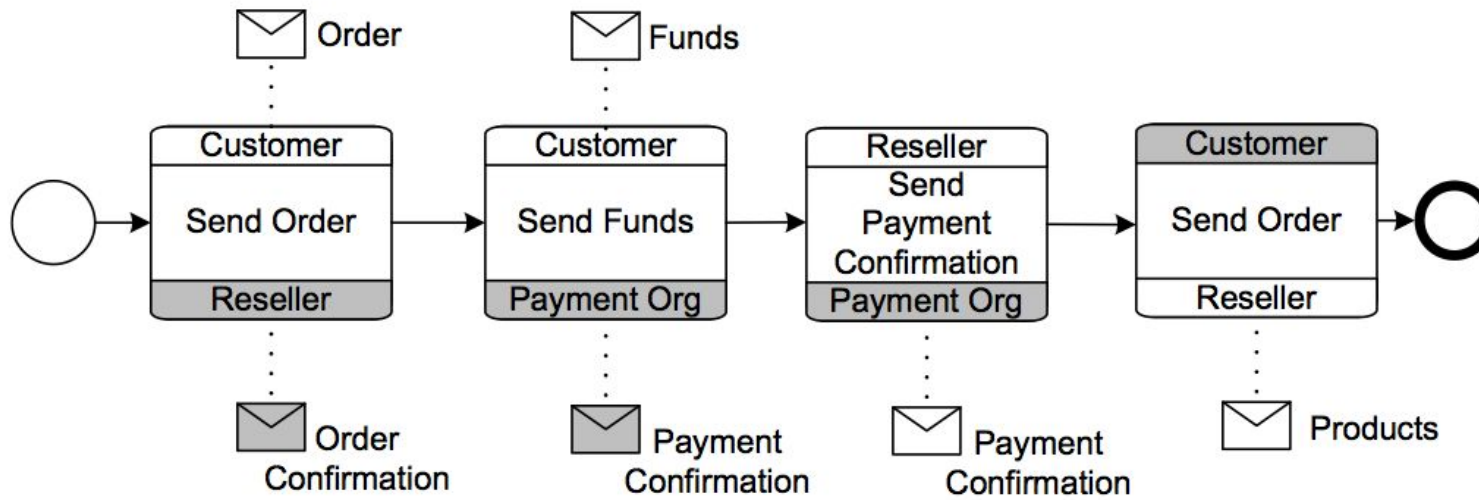

Fig. 5.43. Choreography diagram that is enforceable

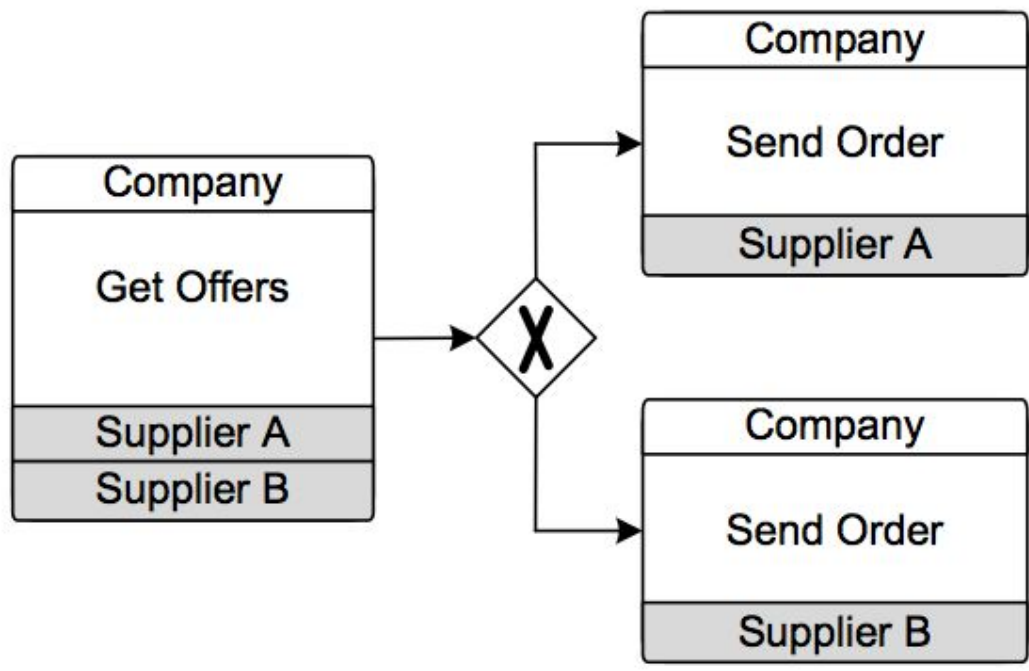

Fig. 5.44. Choreography diagram with exclusive gateway

M. Weske: Business Process Management,
© Springer-Verlag Berlin Heidelberg 2012, 2007

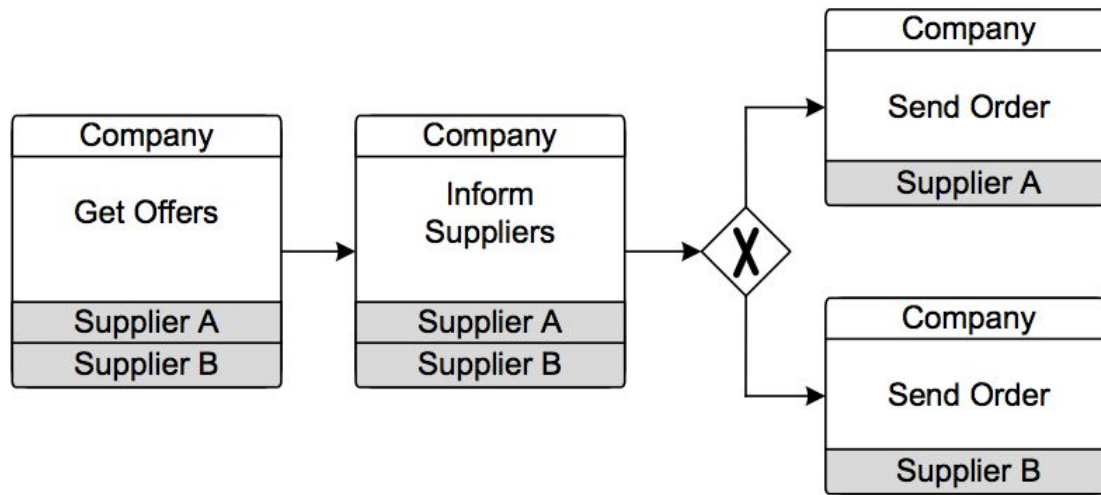
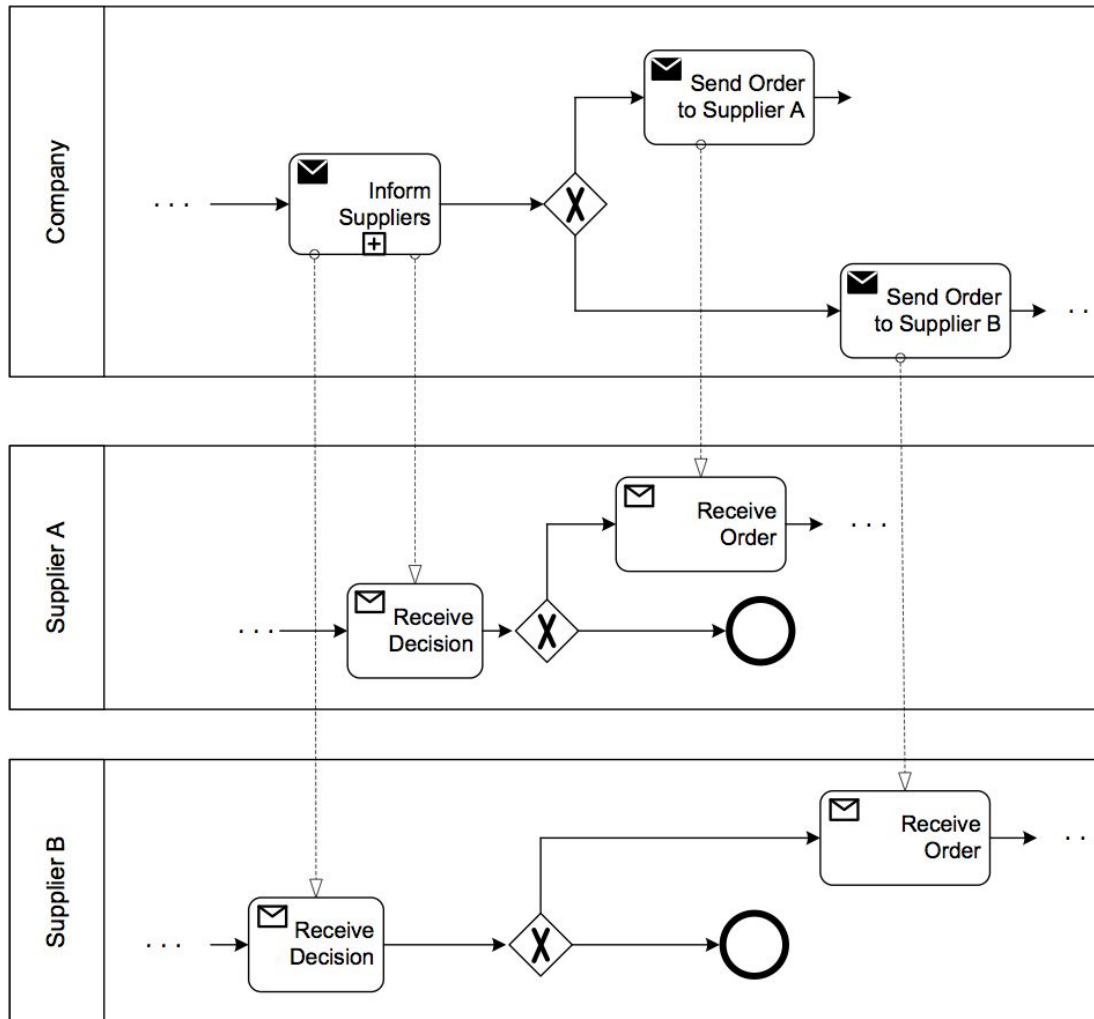

Fig. 5.45. Additional choreography task *Inform Suppliers* makes sure that receivers are informed about the decision taken by the exclusive gateway



M. Weske: Business Process Management,
© Springer-Verlag Berlin Heidelberg 2012, 2007

Fig. 5.46. Collaboration diagram with process orchestrations, implementing the choreography defined in Figure 5.45

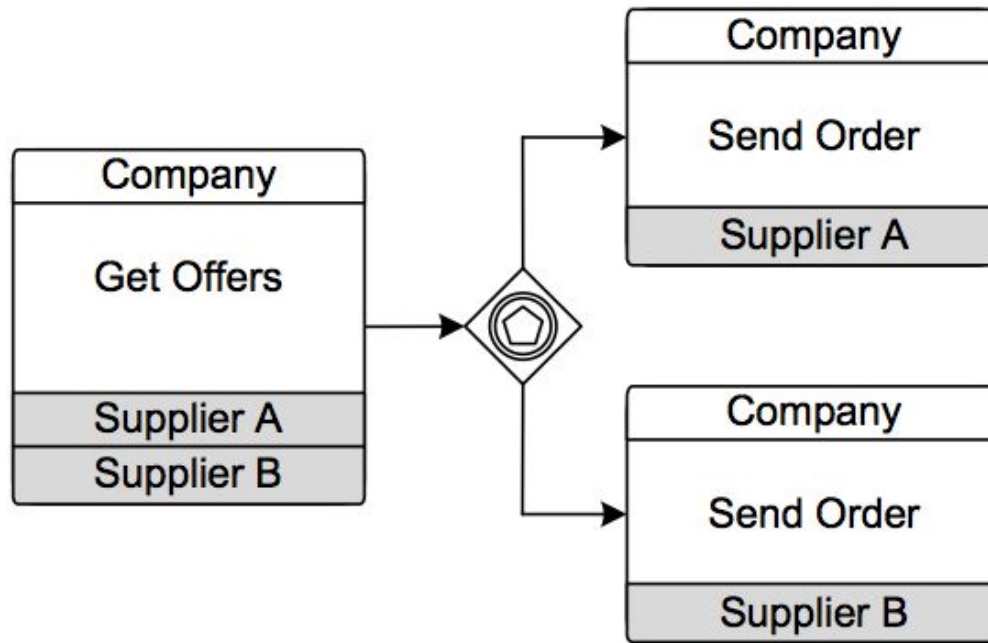
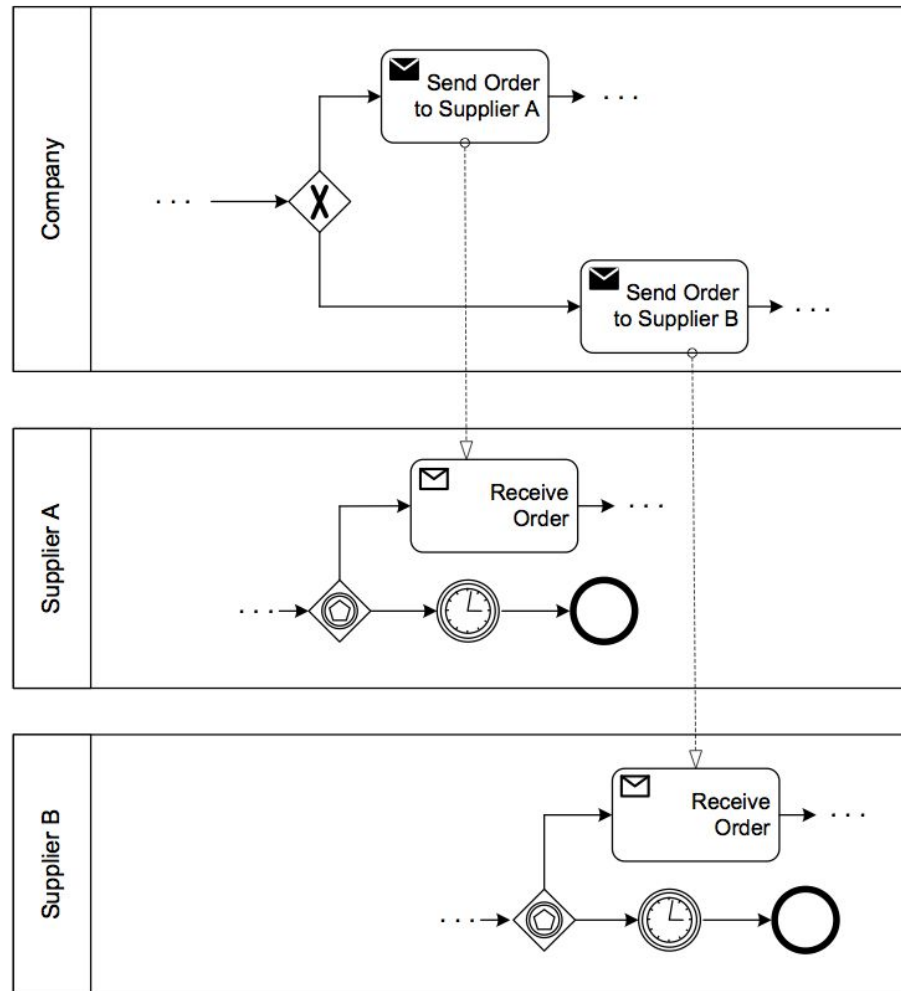

Fig. 5.47. Choreography diagram with event-based gateway

M. Weske: Business Process Management,
© Springer-Verlag Berlin Heidelberg 2012, 2007



M. Weske: Business Process Management,
© Springer-Verlag Berlin Heidelberg 2012, 2007

Fig. 5.48. Collaboration diagram with process orchestrations, implementing the choreography defined in Figure 5.47

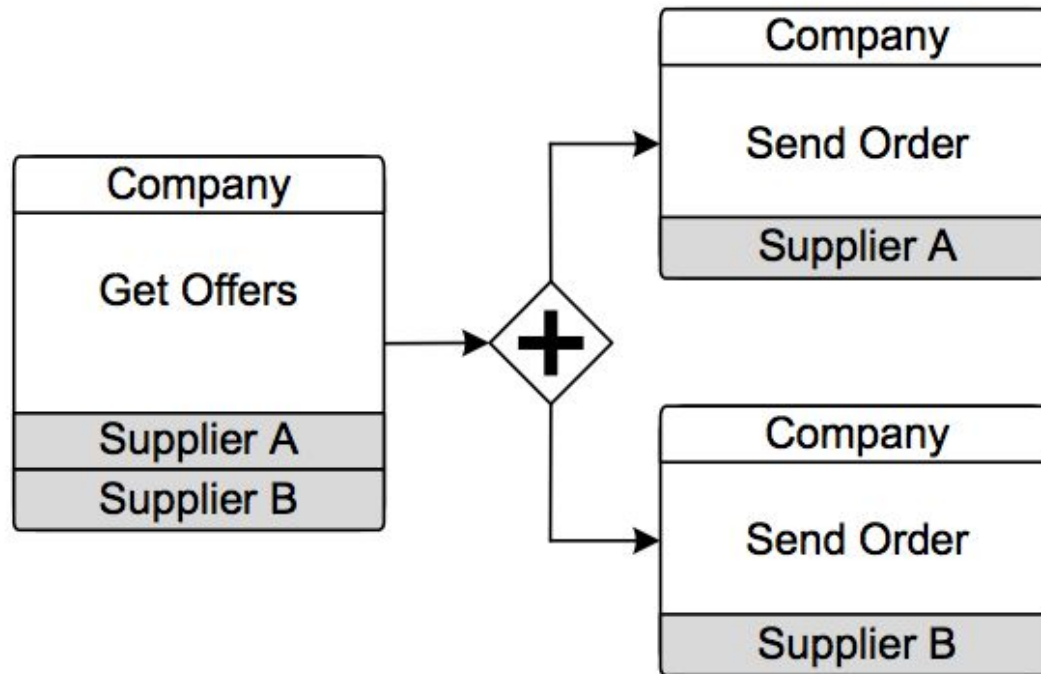
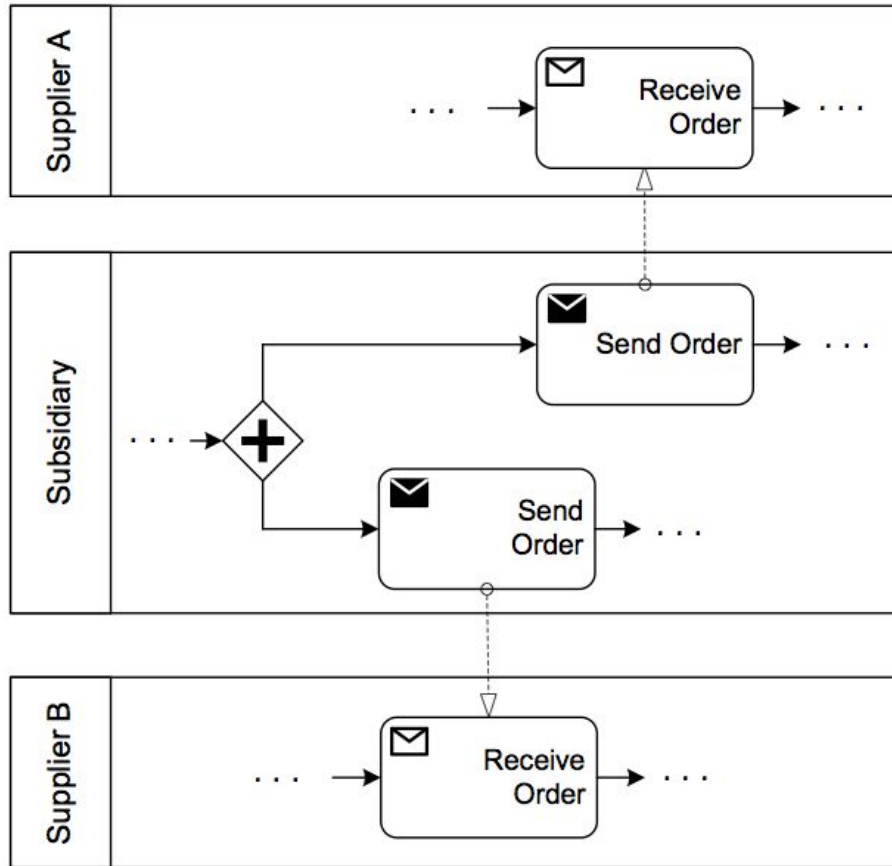

Fig. 5.49. Choreography diagram using parallel gateway

M. Weske: Business Process Management,
© Springer-Verlag Berlin Heidelberg 2012, 2007



M. Weske: Business Process Management,
© Springer-Verlag Berlin Heidelberg 2012, 2007

Fig. 5.50. Process diagram realizing parallel gateway of process choreography

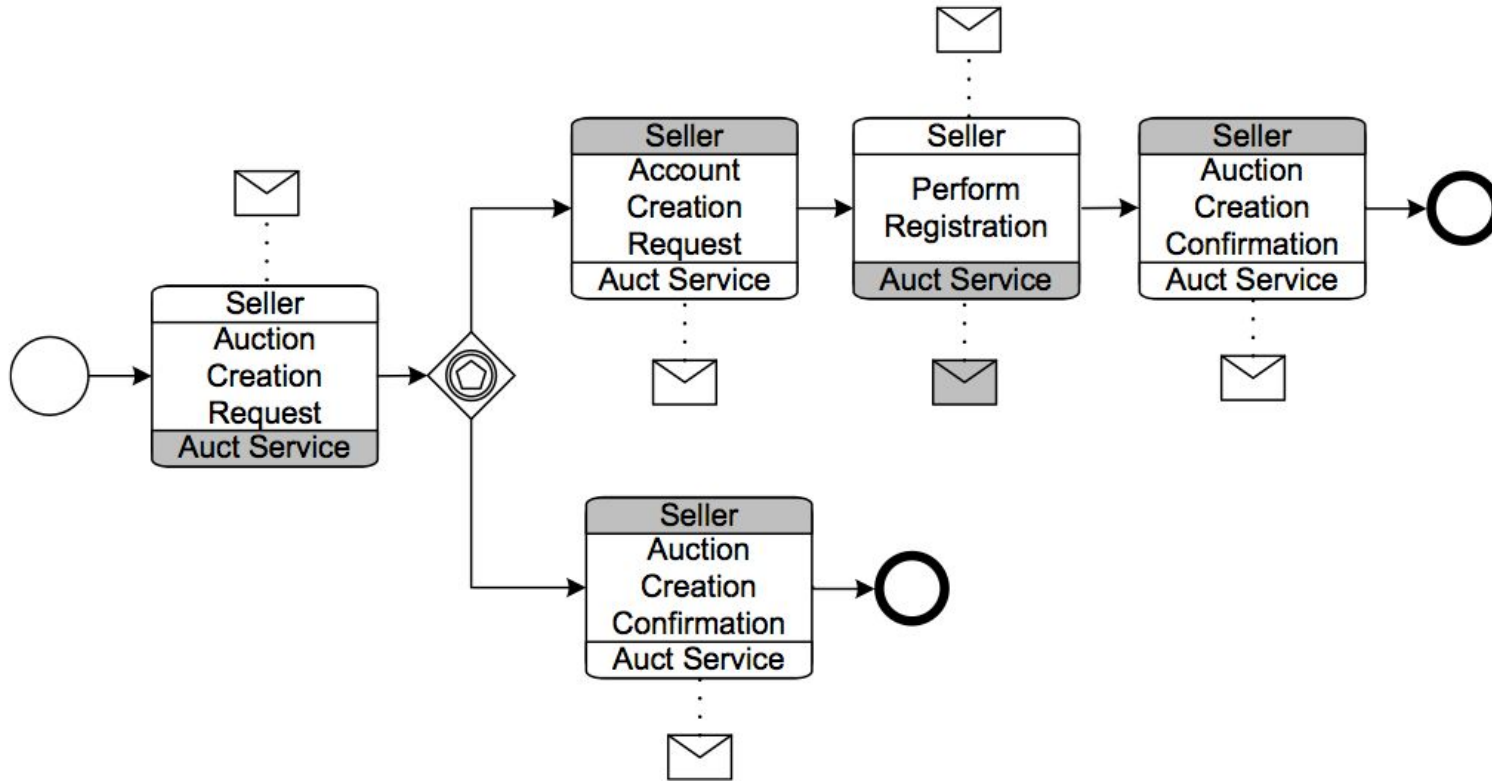

M. Weske: Business Process Management,
© Springer-Verlag Berlin Heidelberg 2012, 2007

Fig. 5.51. Choreography diagram representing auctioning scenario