

**СИСТЕМЫ НАПРАВЛЕННОЙ
ДОСТАВКИ ЛЕКАРСТВЕННЫХ
ВЕЩЕСТВ**

Микрокапсулы

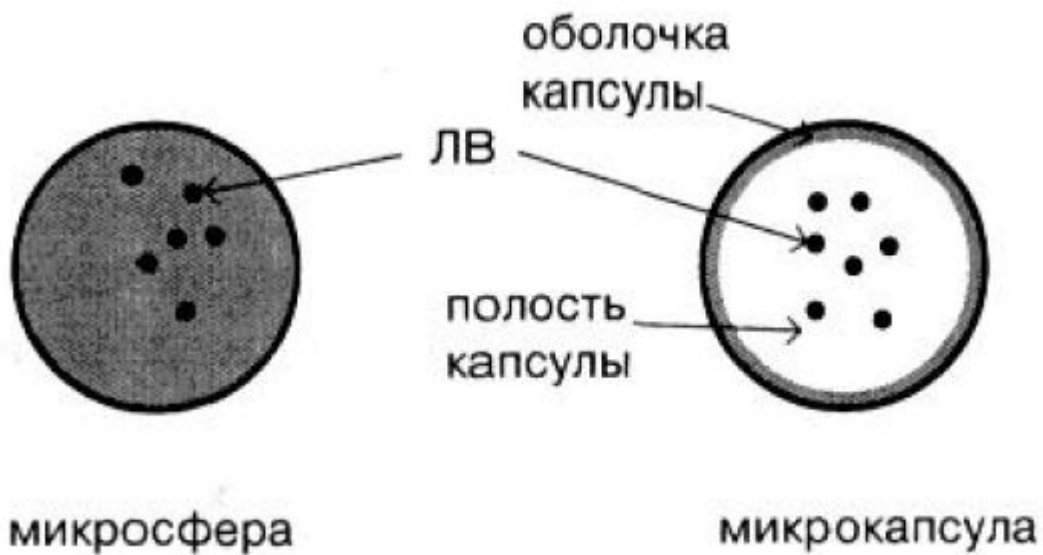

Микросферы

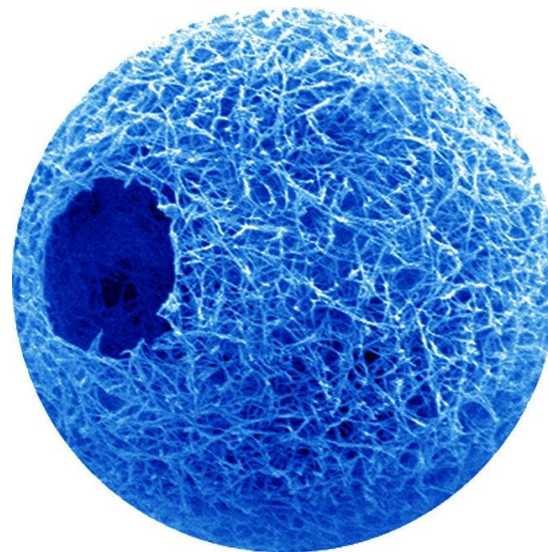

Липосомы

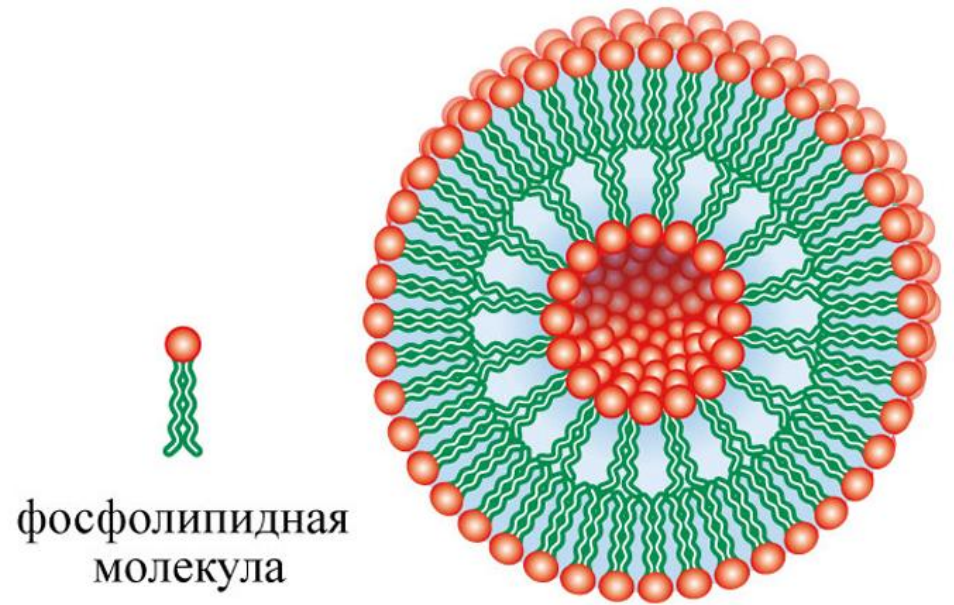
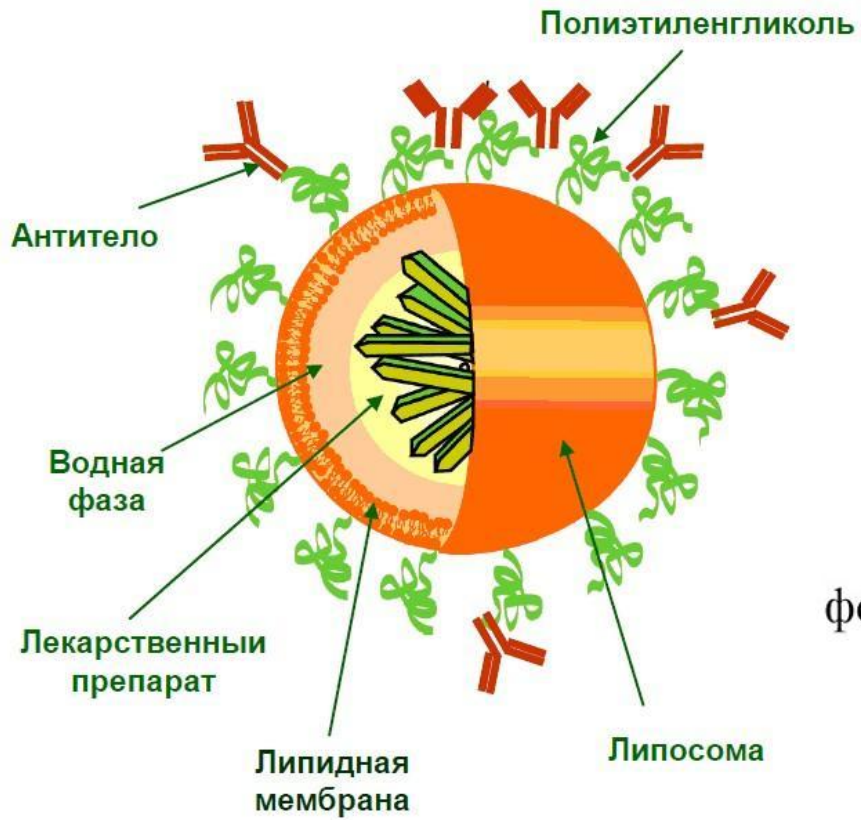

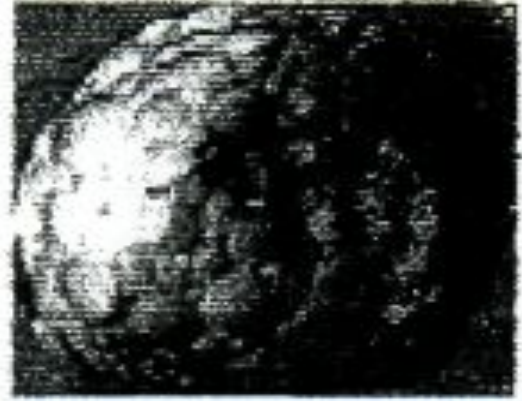

Строение липосом: - однослойная липосома; - многослойная однокамерная липосома; - многокамерная липосома.

Ниосомы

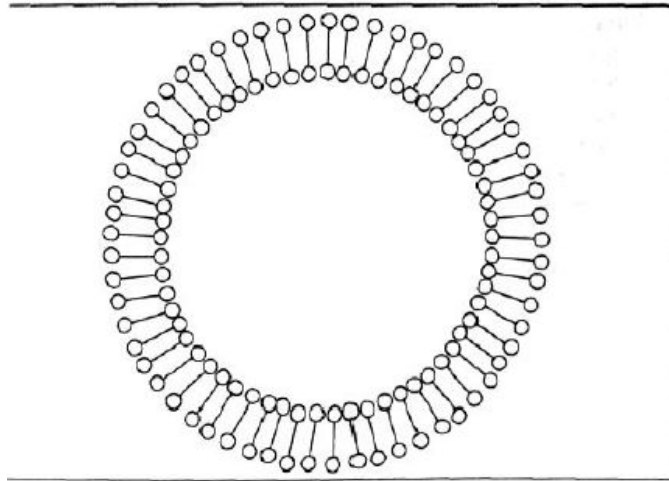

Наночастицы

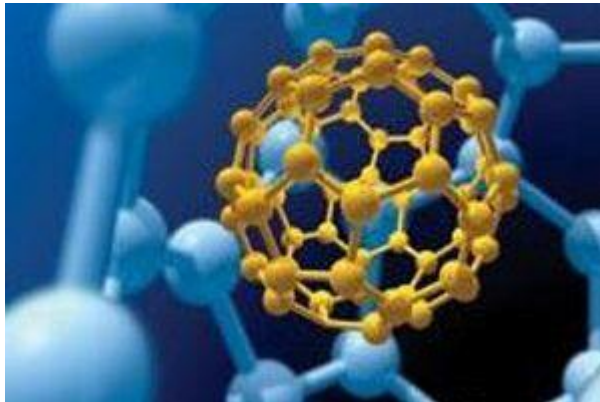

Мицелий

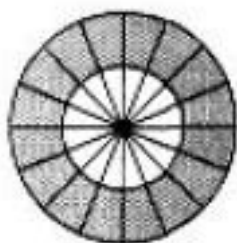
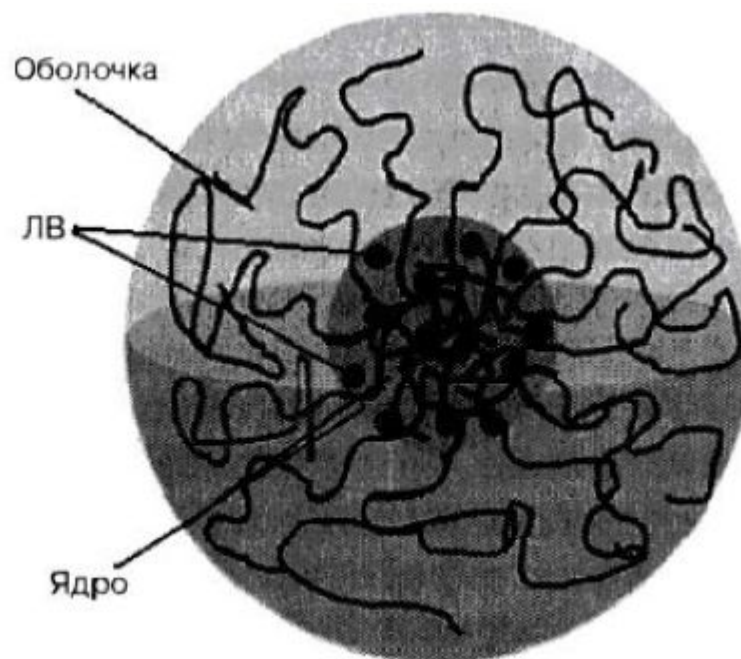

мицелий с оболочкой

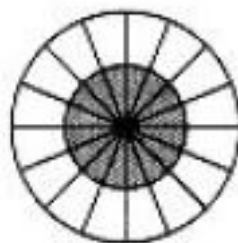

мицелий с ядром



мицелий с
повышенно-активными
веществами

Дендримеры

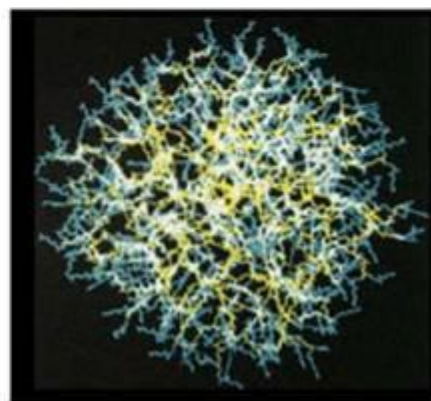
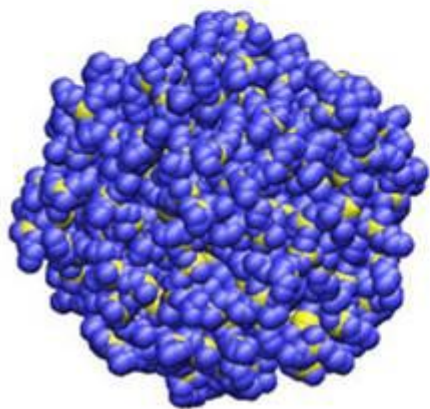
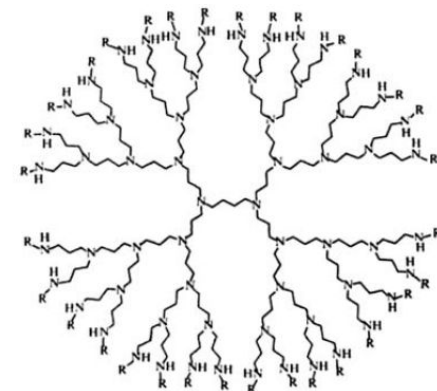
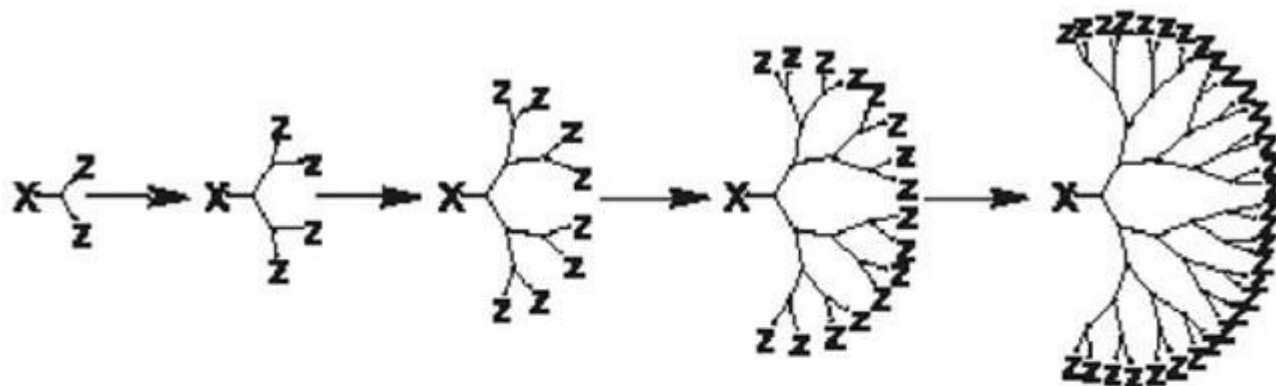

Циклодекстрины

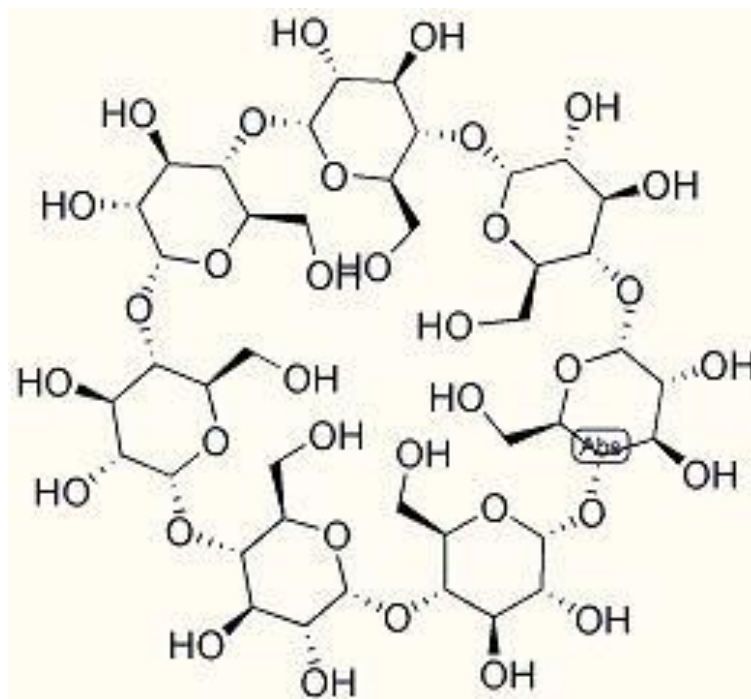

**СИСТЕМЫ КОНТРОЛИРУЕМОЙ
ДОСТАВКИ ЛЕКАРСТВЕННЫХ
ВЕЩЕСТВ**

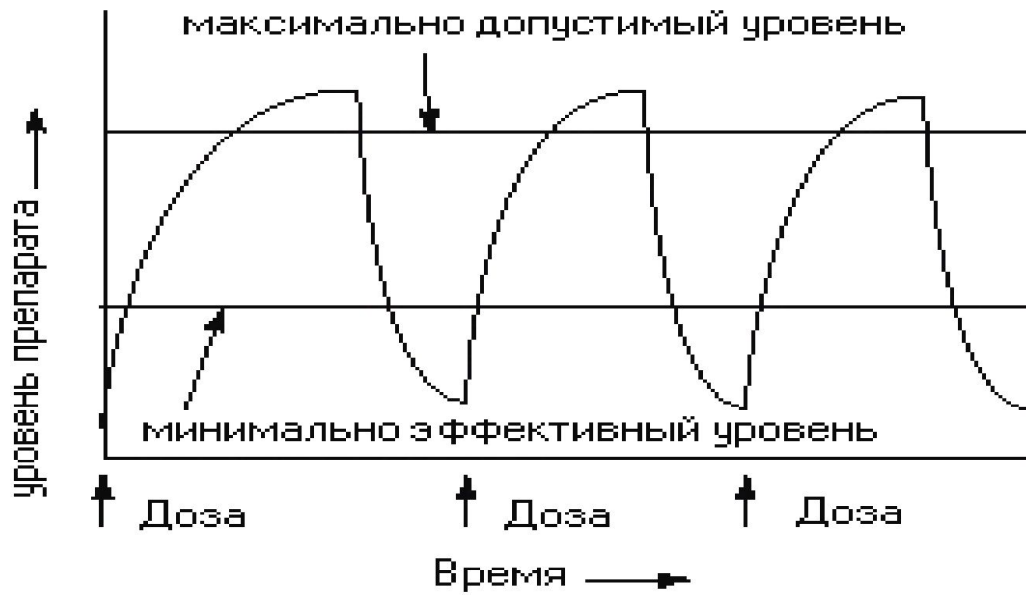

Препараты
повторного
действия



Препараты
поддерживающего
действия

Гидрогели

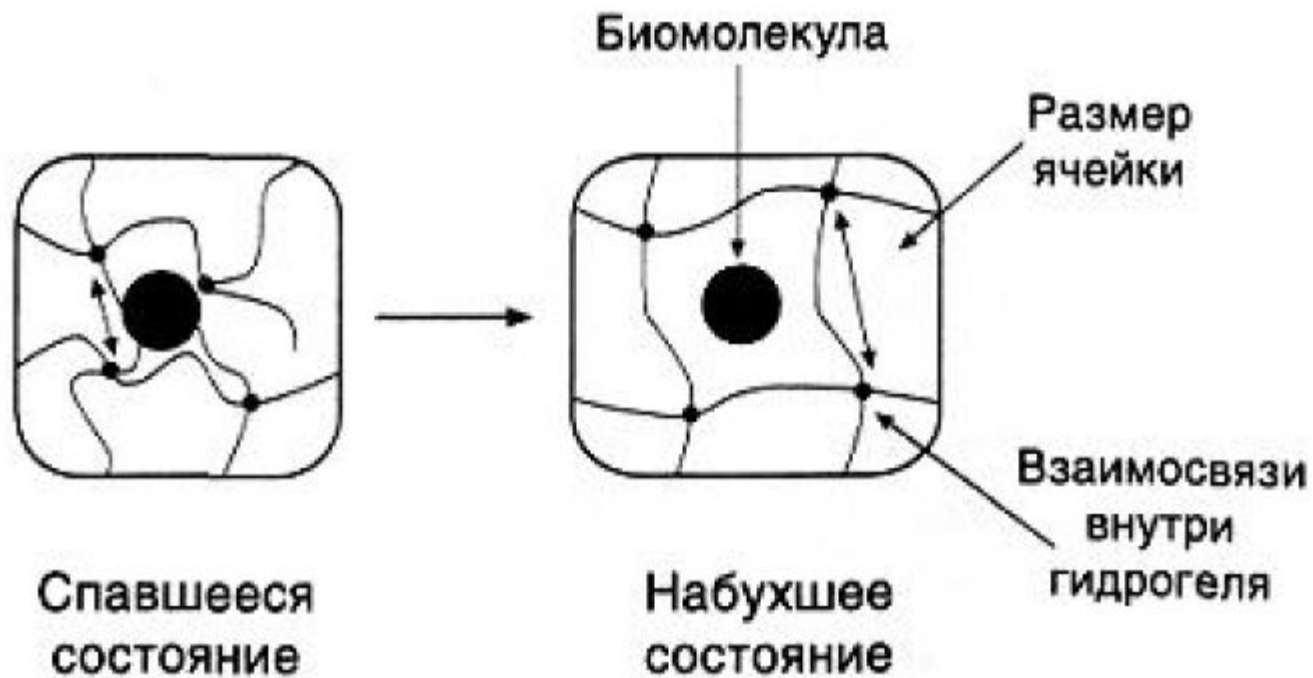

Трансдермальные терапевтические системы

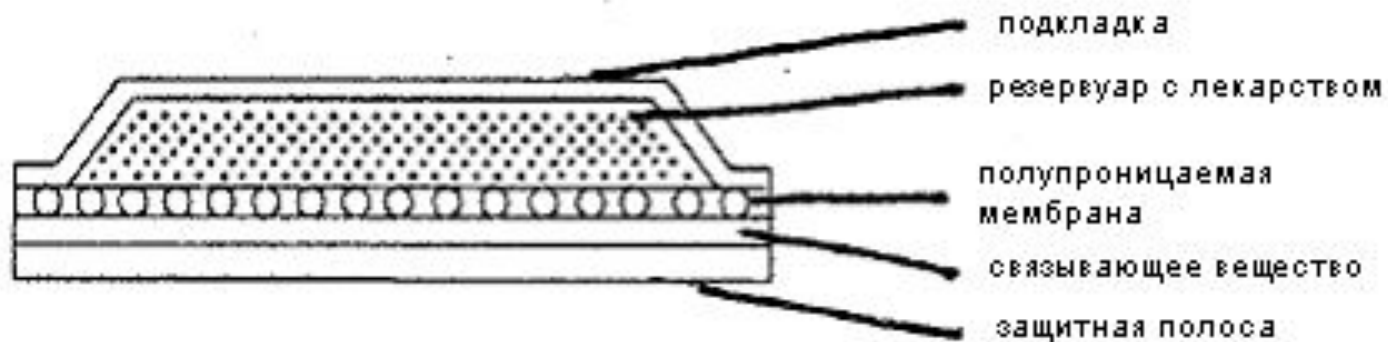

Режимы высвобождения лекарственных веществ

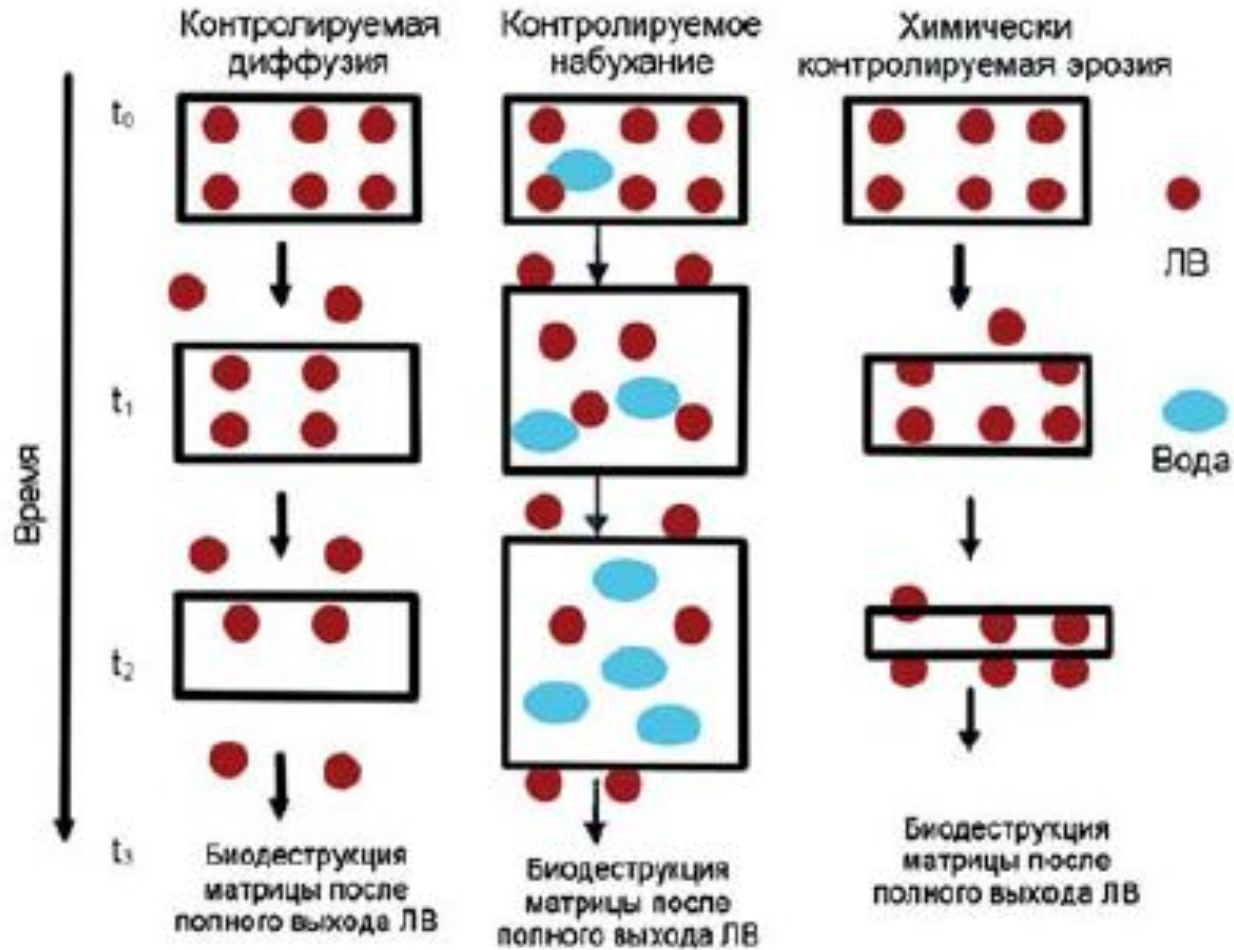

$$J_s^w = -D \nabla c_s$$

$$\frac{dc_s}{dt} = \frac{\partial}{\partial x} \left(D_s \frac{\partial c_s}{\partial x} \right)$$

$$\frac{\partial c_s}{\partial t} = D_s \frac{\partial^2 c_s}{\partial x^2}$$

$$\frac{G_s}{G_{\infty}} = 1 - \frac{8}{\pi^2} \sum_{n=0}^{\infty} \frac{1}{(2n+1)^2} \exp \left[-\frac{D(2n+1)^2 \pi^2 t}{4l^2} \right]$$

$$\frac{G_s}{G_\infty} = 1 - \frac{8}{\pi^2} \exp\left[\frac{-Dt\pi^2}{l^2}\right]$$

$$D = \frac{l^2}{\pi^2} \operatorname{tg} \alpha$$

$$\ln\left(1 - \frac{G_s}{G_\infty}\right) = \ln \frac{8}{\pi^2} - \frac{\pi^2 Dt}{l^2}$$

$$\frac{G_s}{G_\infty} = \frac{4}{\pi^{1/2}} \left(\frac{Dt}{l^2}\right)^{1/2}$$

$$D = \frac{\pi l^2}{16} (\operatorname{tg} \alpha)^2$$

$$Q_t = Q_0 + K_0 t$$

$$\text{Log} Q_t = \text{Log} Q_0 - K_1 t / 2.303$$

$$Q_0^{1/3} - Q_t^{1/3} = K_{HC} t$$

$$\text{Log} \frac{C_s}{C_s - C_t} = Kt / 2.303$$

$$M = 1 - \exp[-\{(t - T_i)^b\} / a]$$

$$\frac{M_t}{M_\infty} = 1 - [1 - k_0 t / C_0 a_0]^n$$

$$\frac{M_t}{M_\infty} = K t^{1/2}$$

$$\frac{M_t}{M_\infty} = K t^n$$

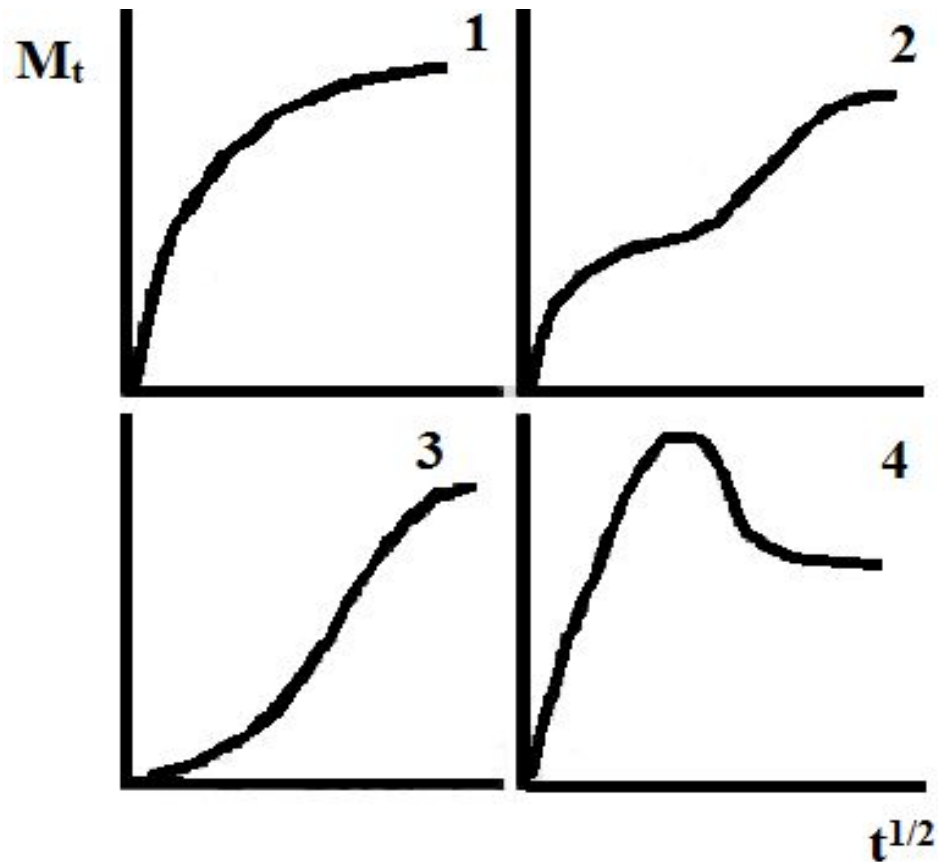

Кинетические кривые аномальной сорбции: 1- псевдонормальная; 2- двухстадийная; 3- S-образная; 4- экстремальная