

СВЕТОФОРЫ



Н.Н.Стрекалов, Ю.В.Попов

@ГБОУ СПО Железнодорожный колледж № 52

Классификация сигналов

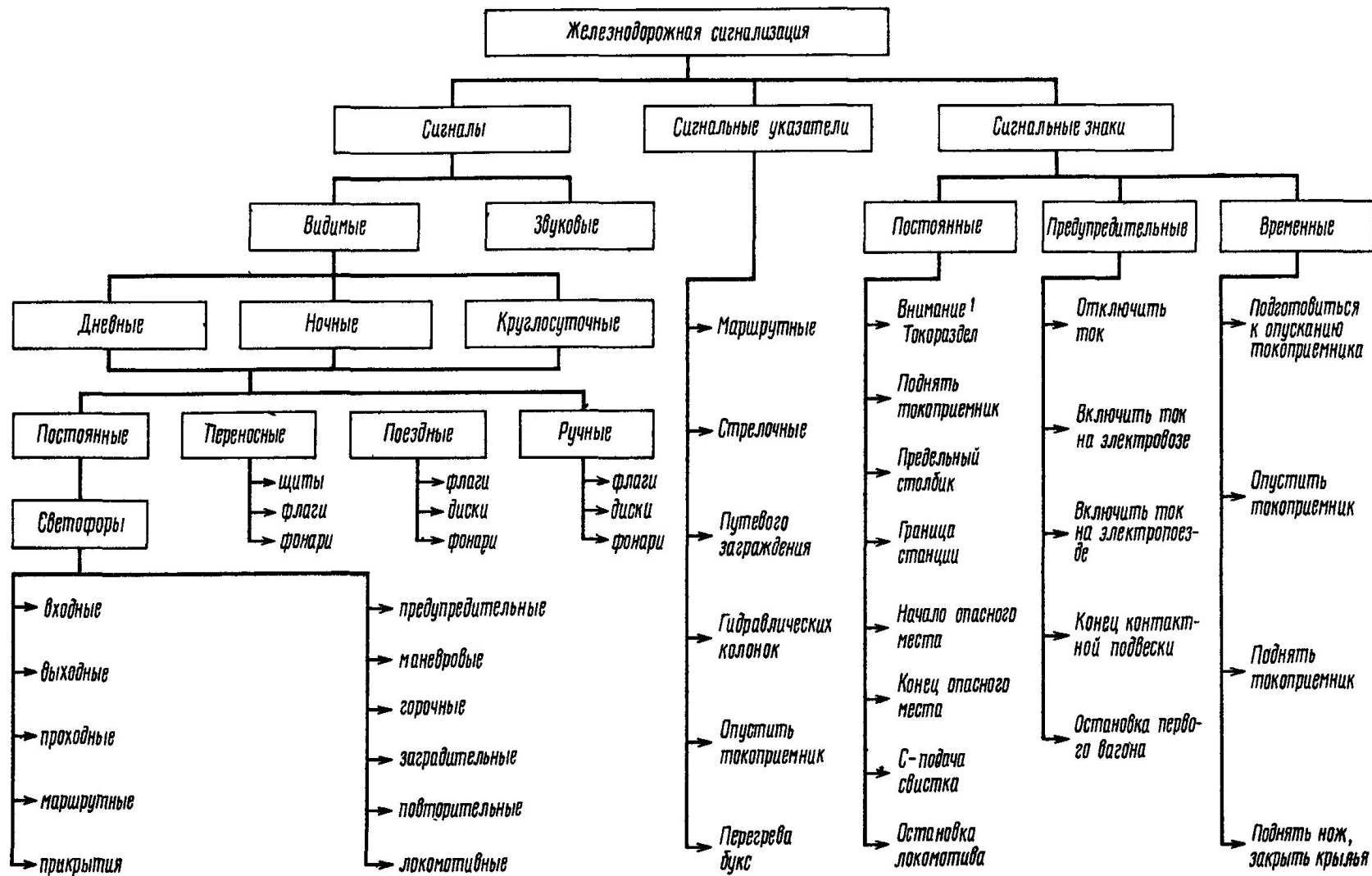

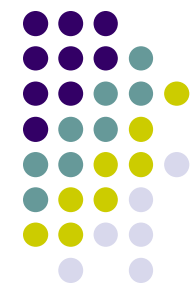

Типы светофоров

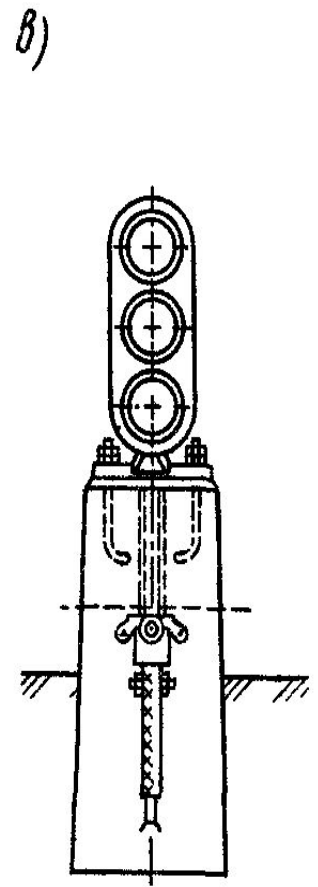
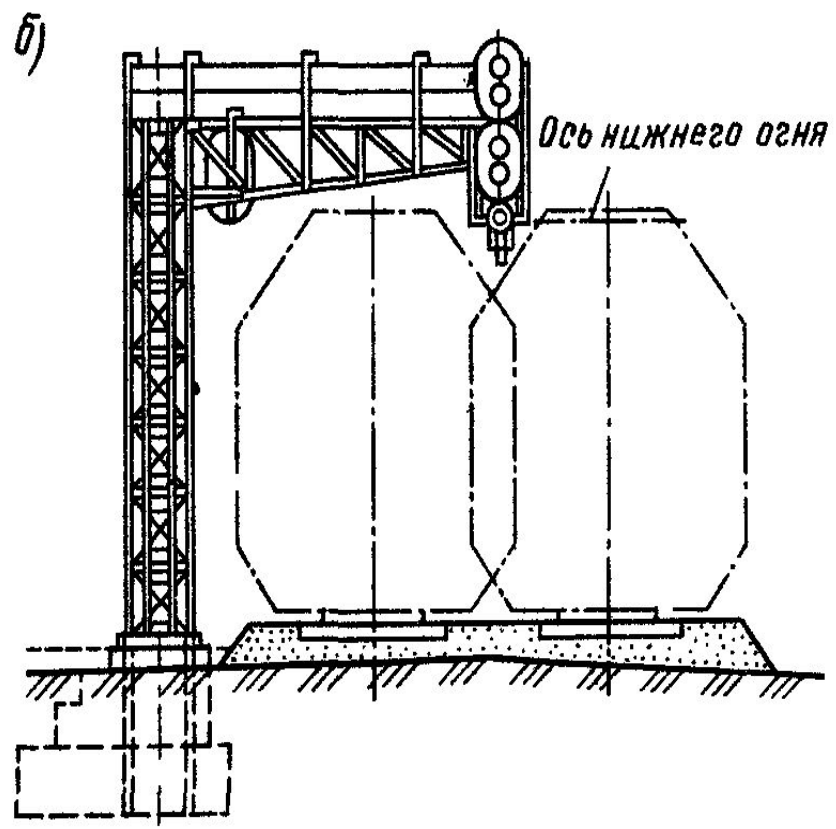
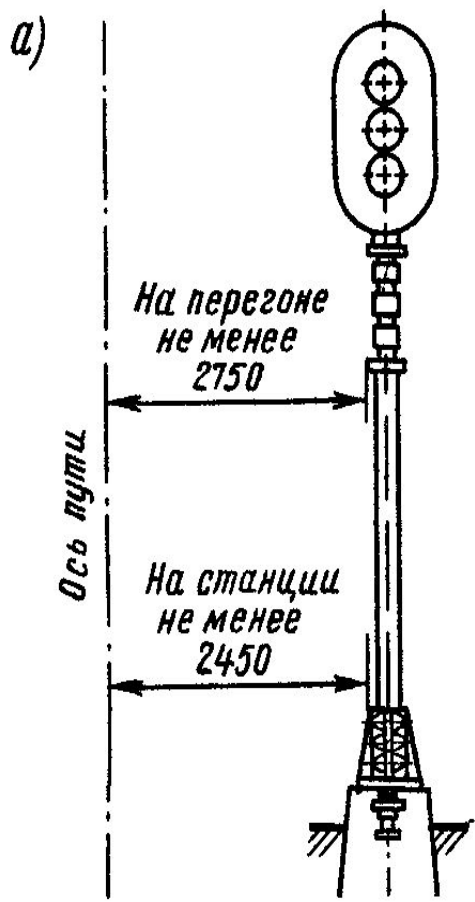

Устройство линзового светофора



Рис 20.3 Устройство линзового светофора:

1 — корпус головки, 2 — козырек, 3 — фоновый щиток, 4 — мачта; 5 — внутренняя цветная линза, 6 — наружная бесцветная линза, 7 — рассеивающее стекло

Сигналы входных светофоров



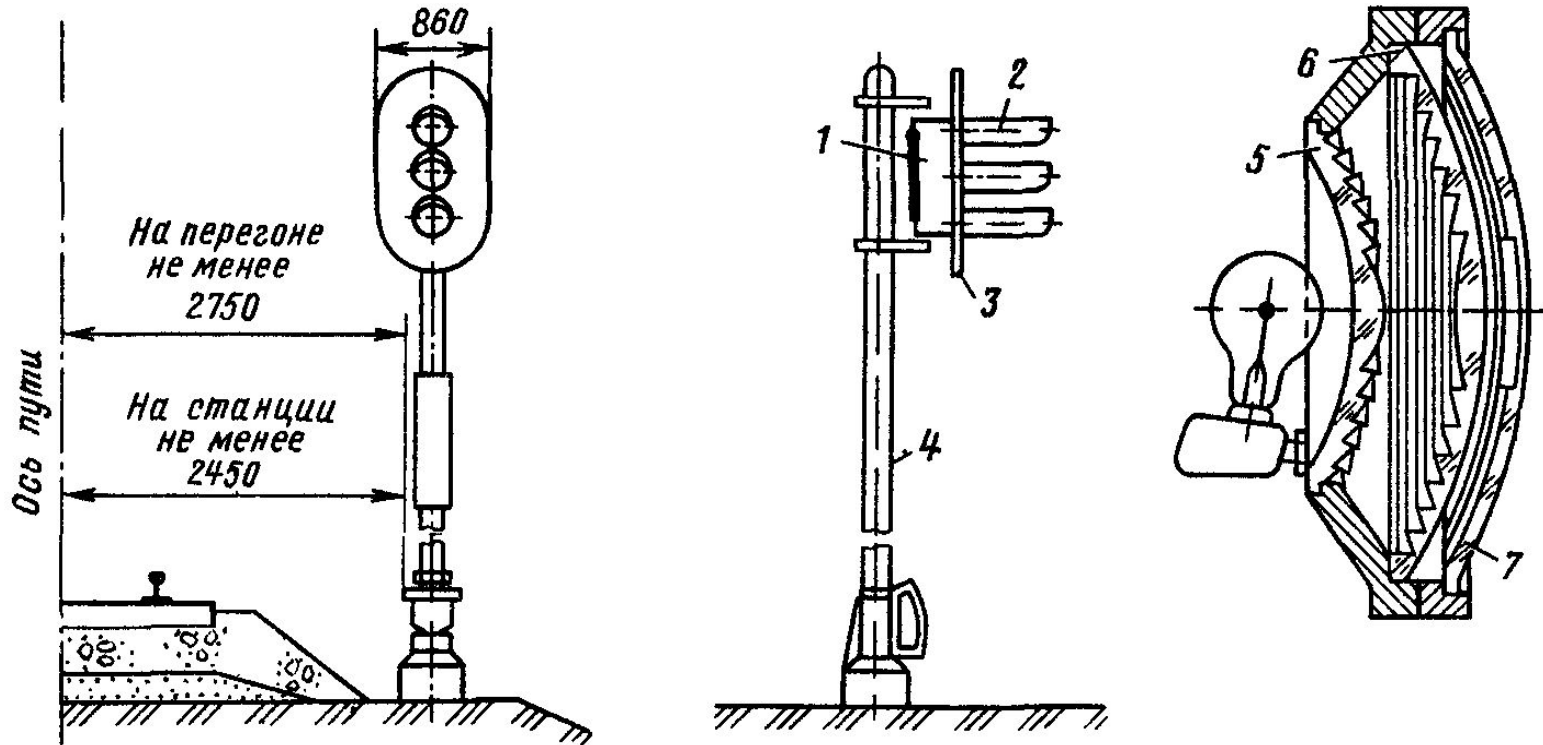
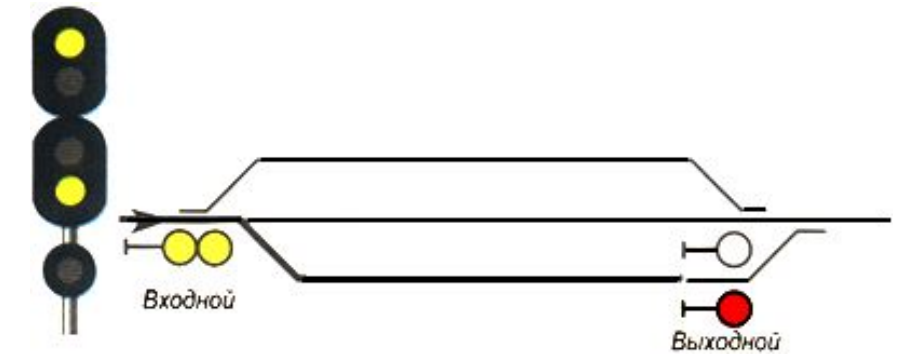
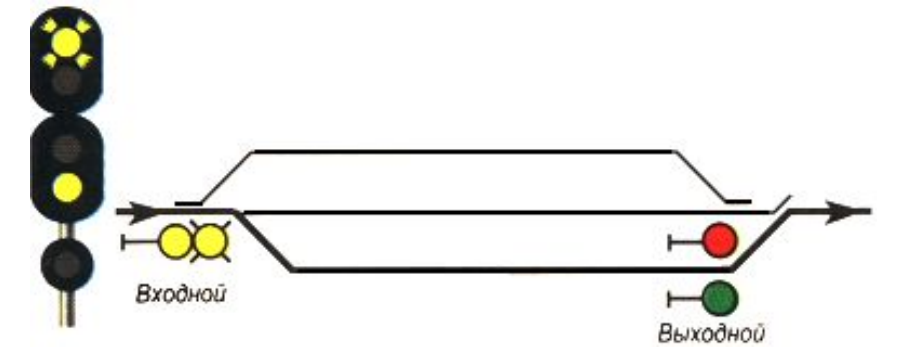
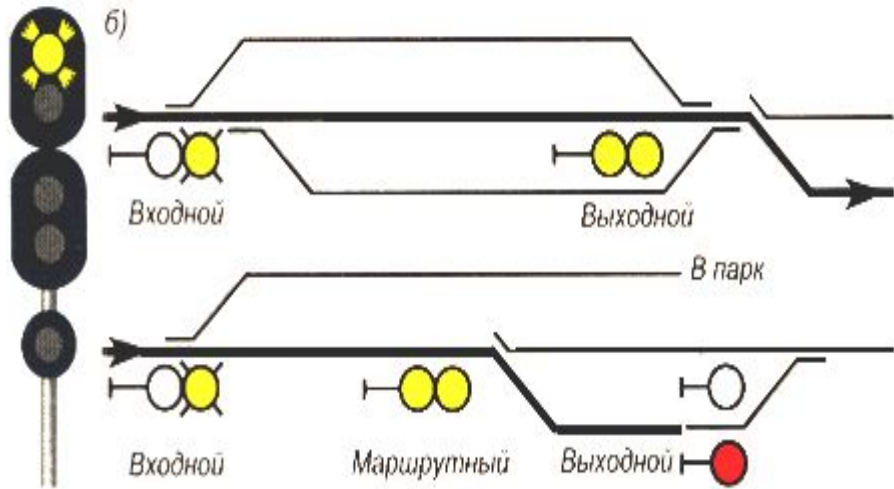
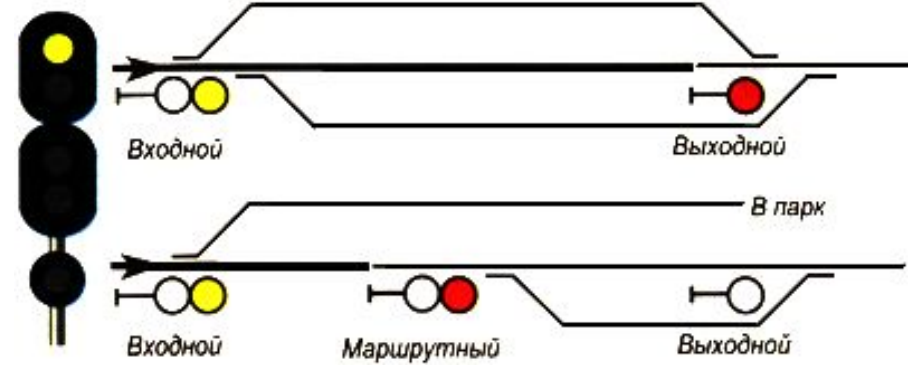
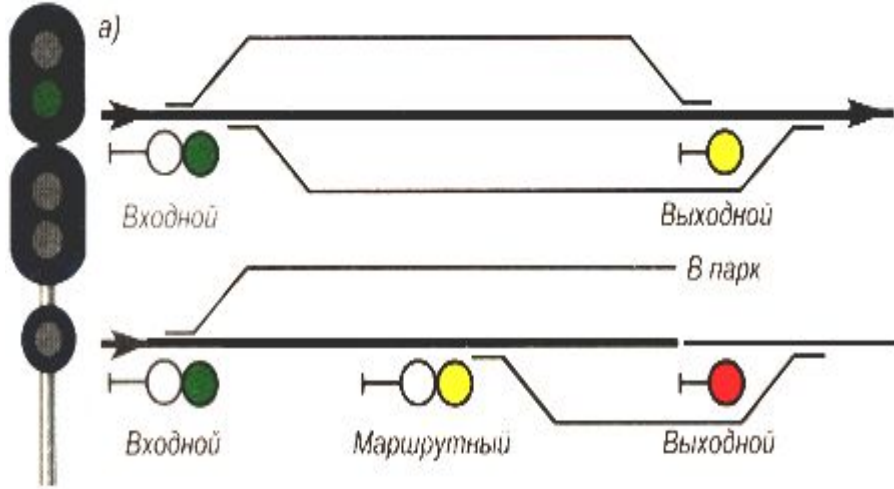
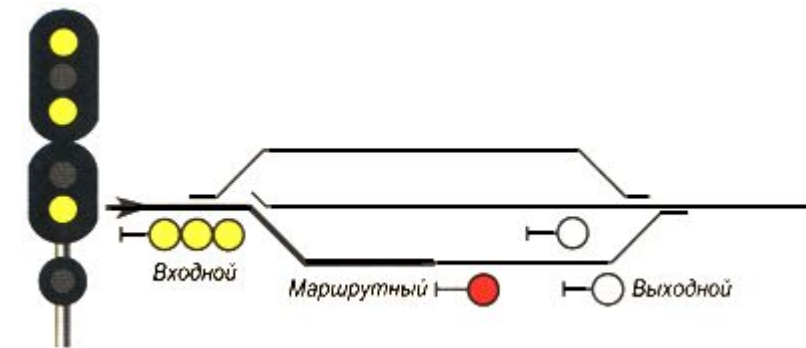
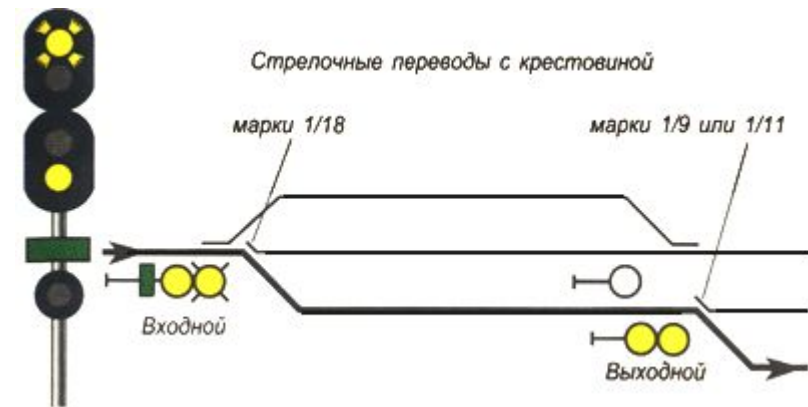
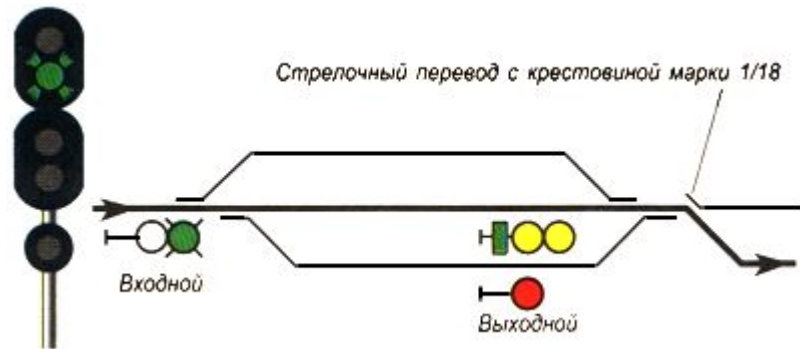
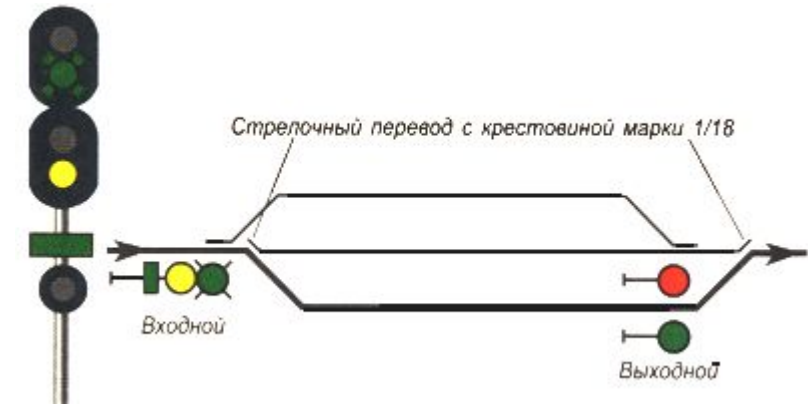
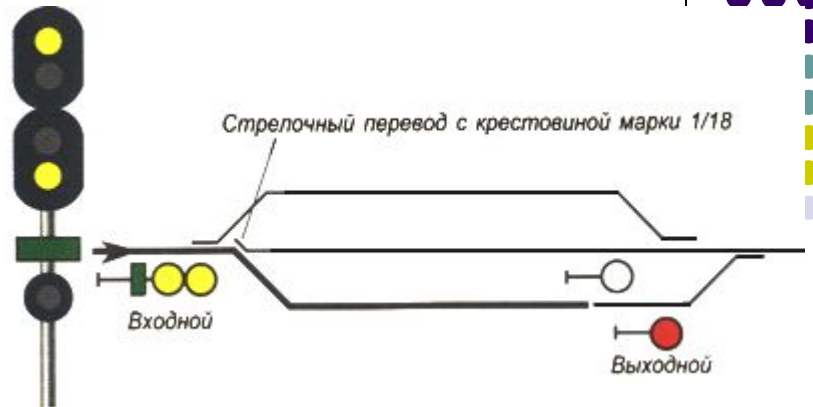
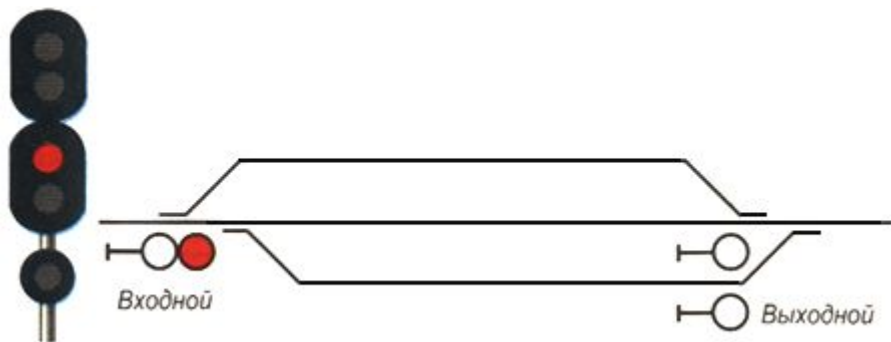

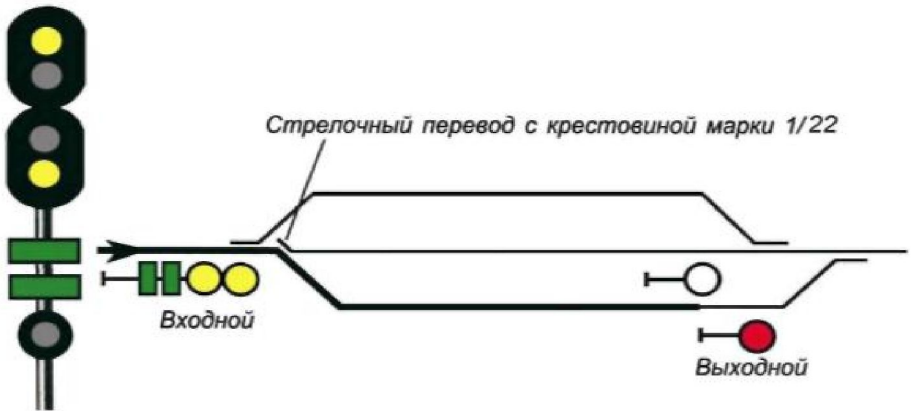
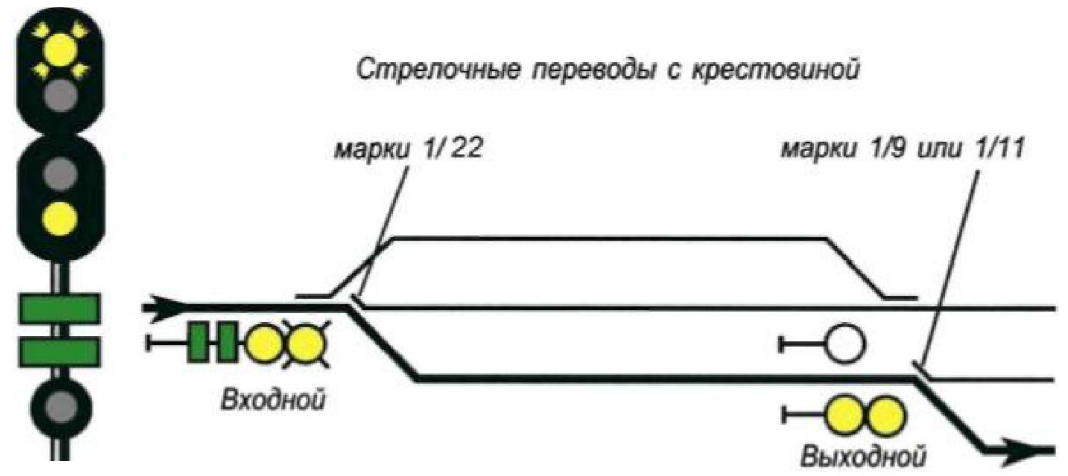
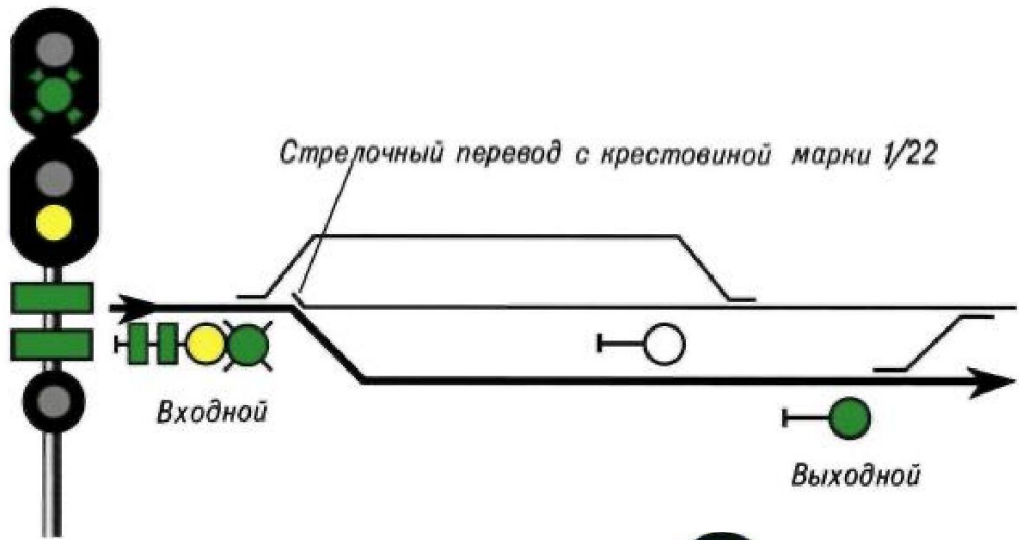
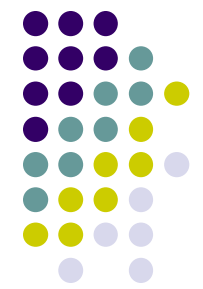

Пригласительный сигнал

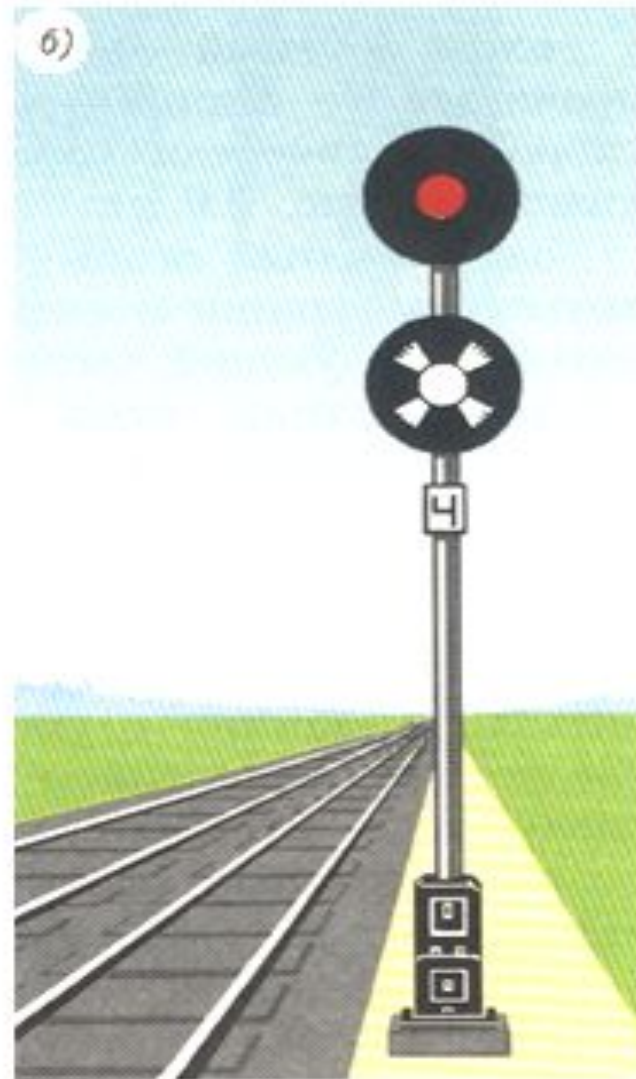
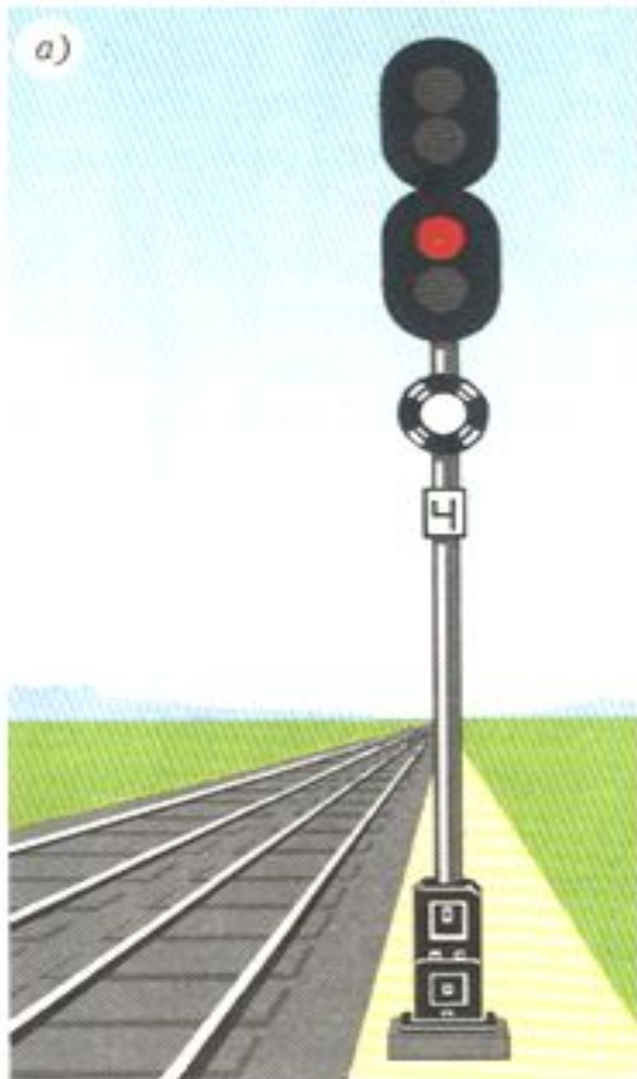

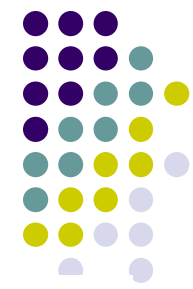

Сигналы выходных светофоров

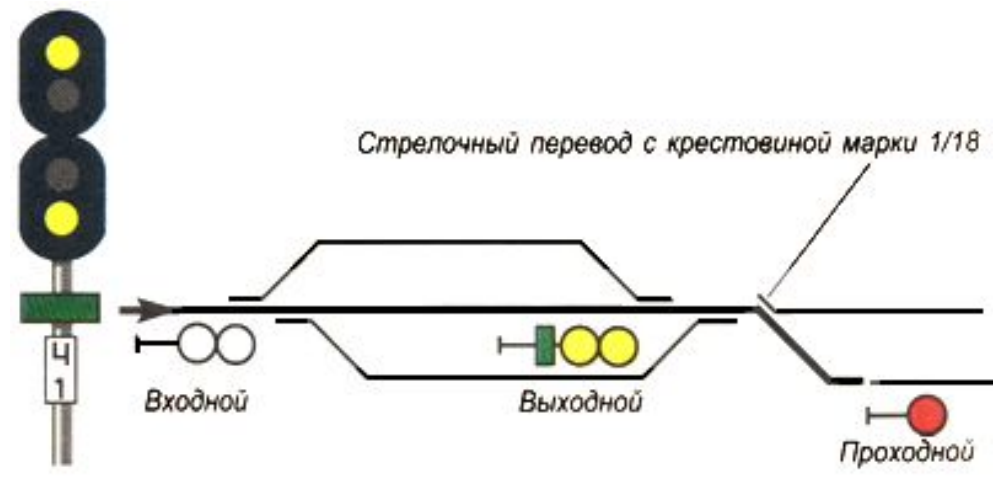
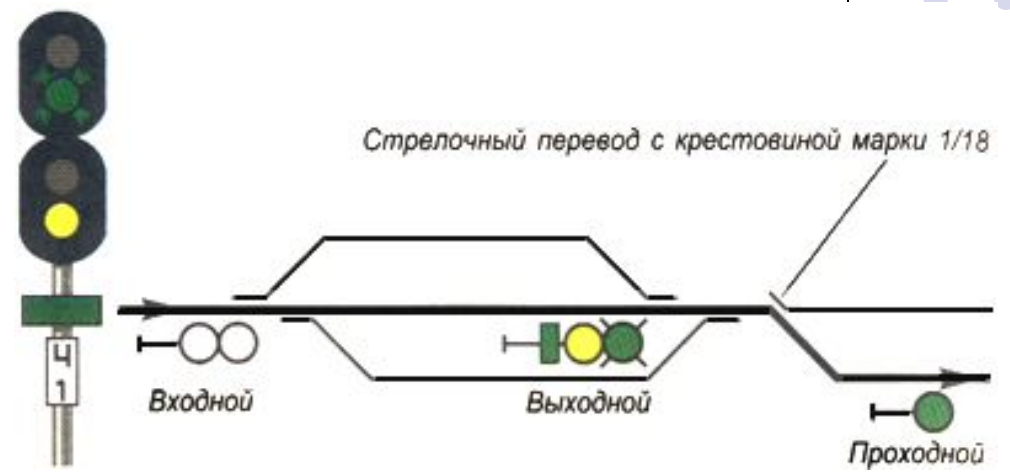
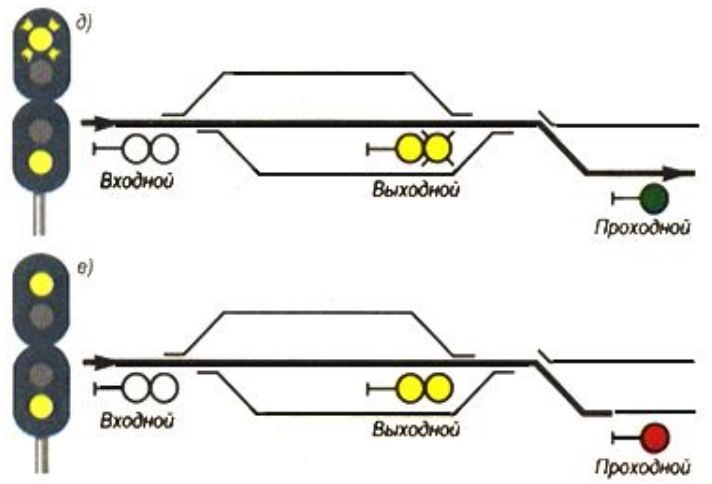
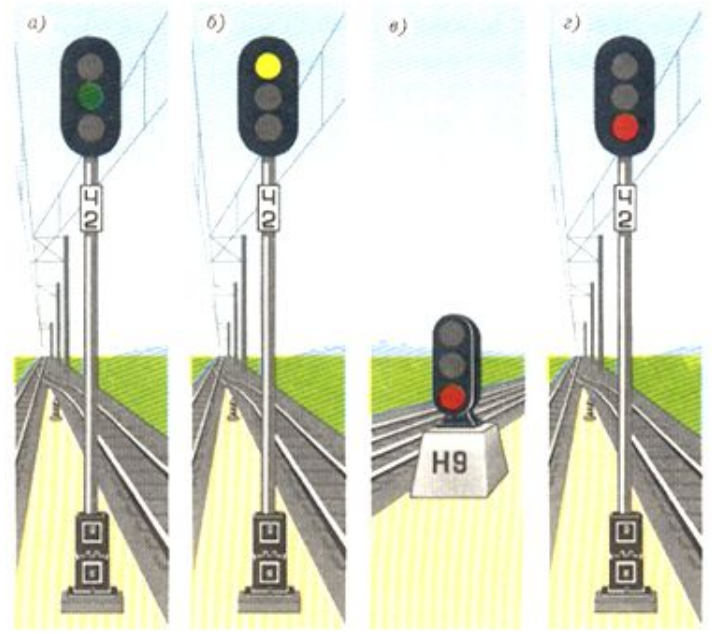

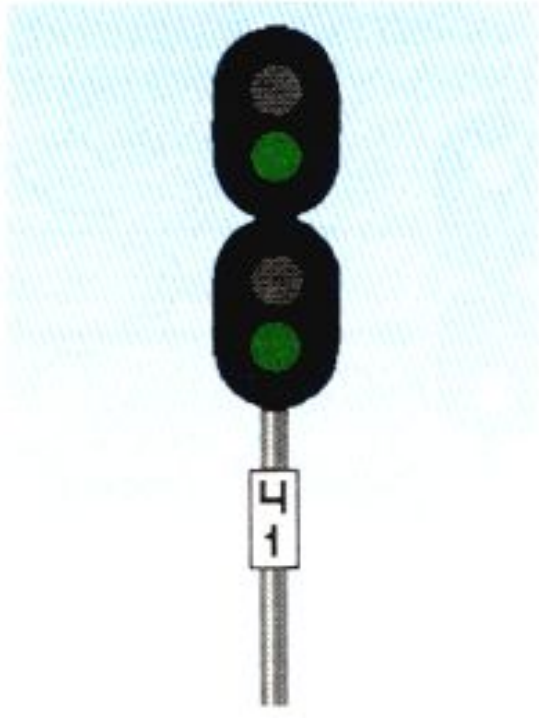
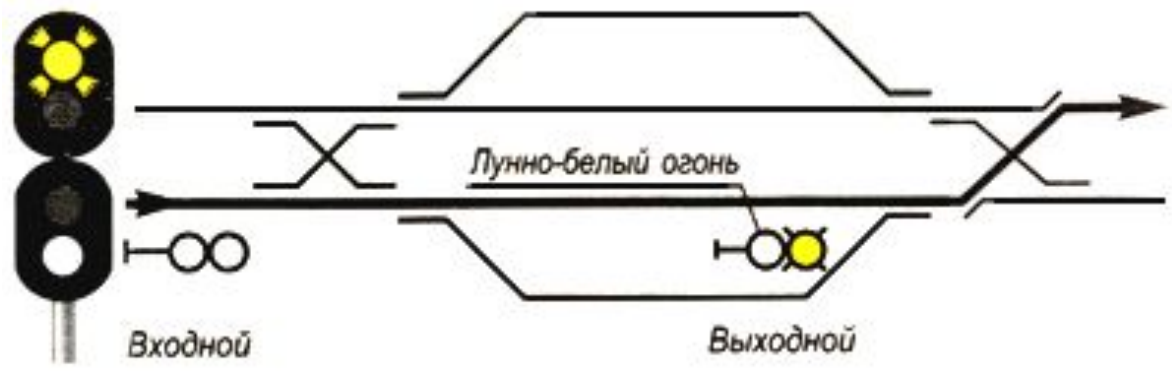
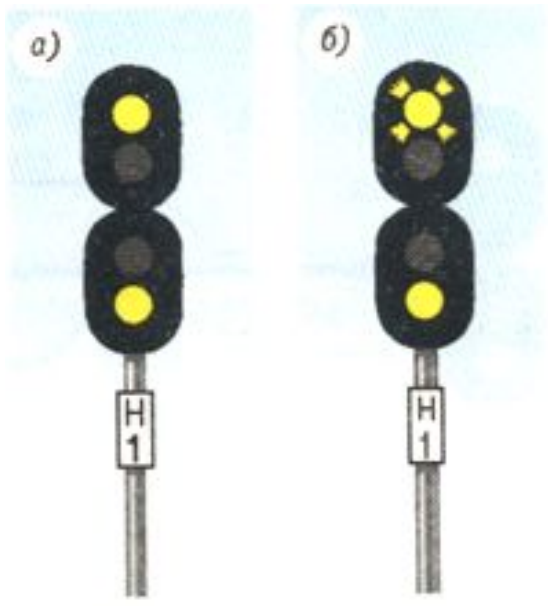

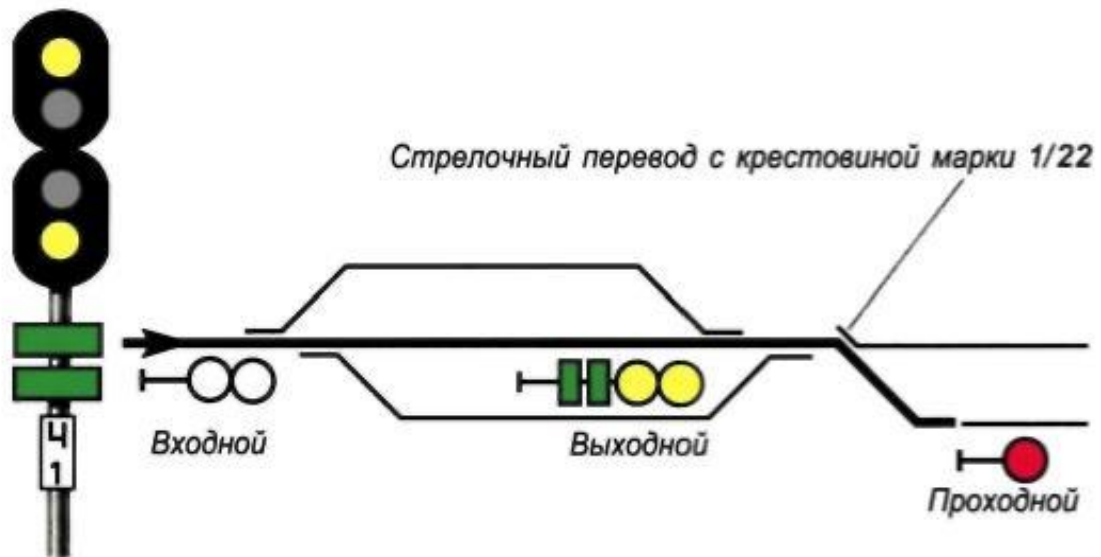
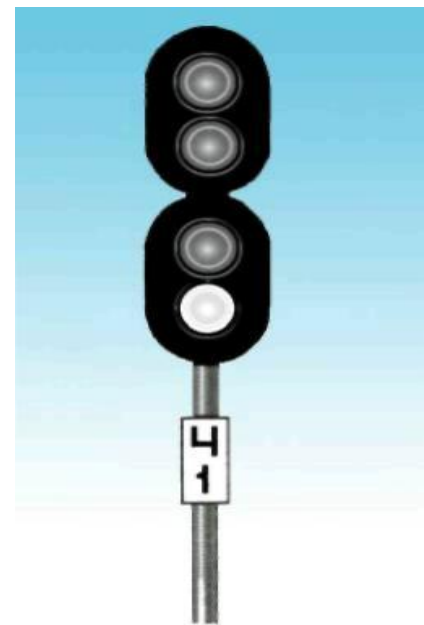
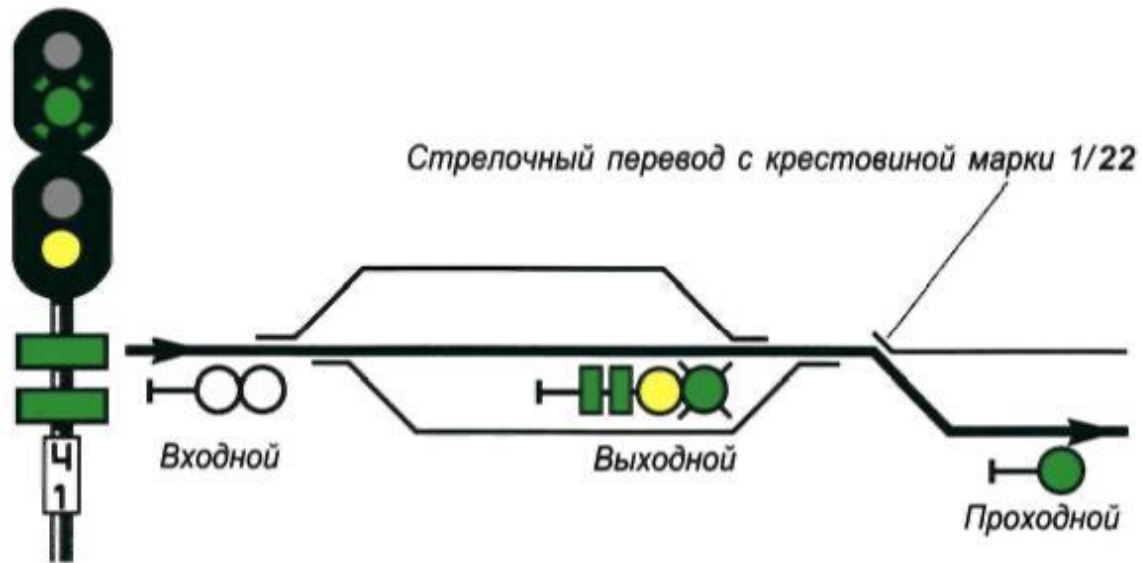

Сигналы выходных светофоров на участках с полуавтоблокировкой





Сигналы проходных светофоров

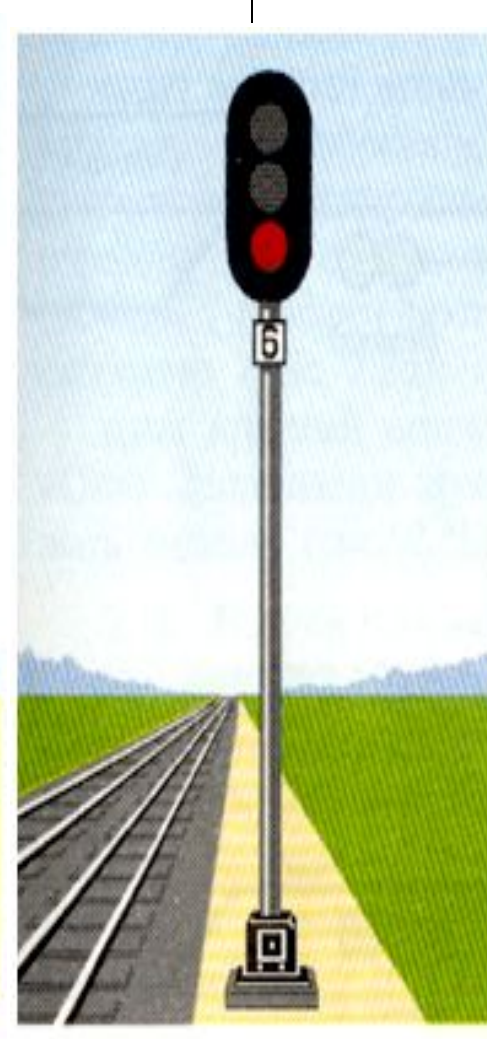
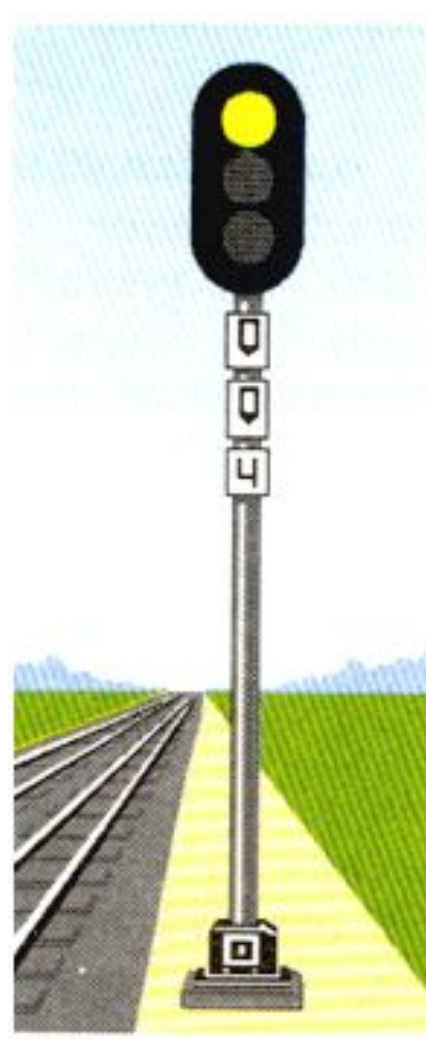
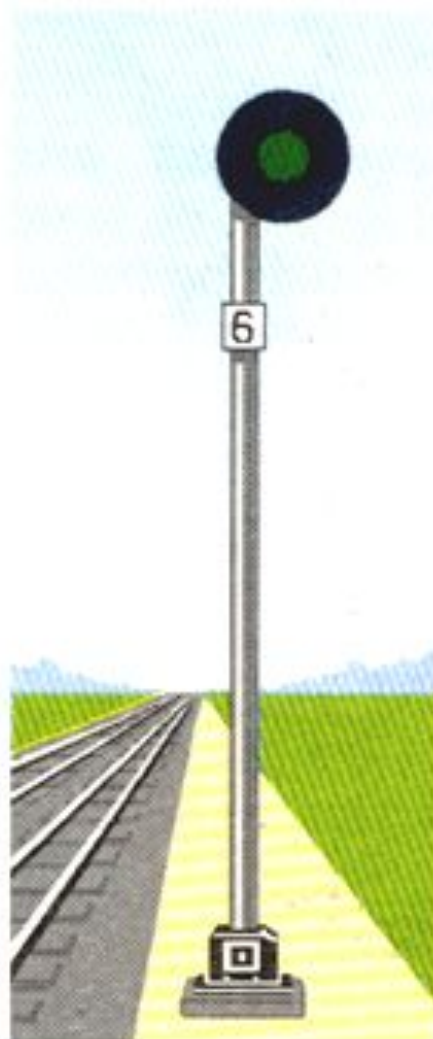
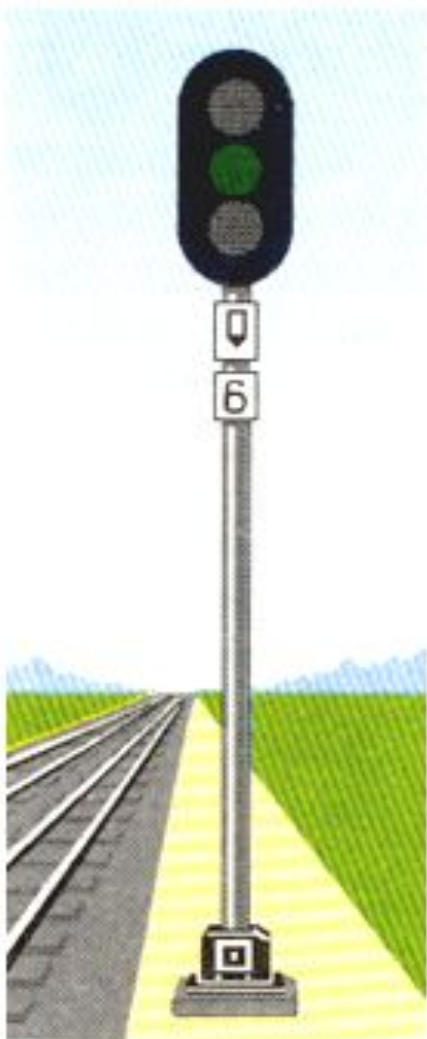

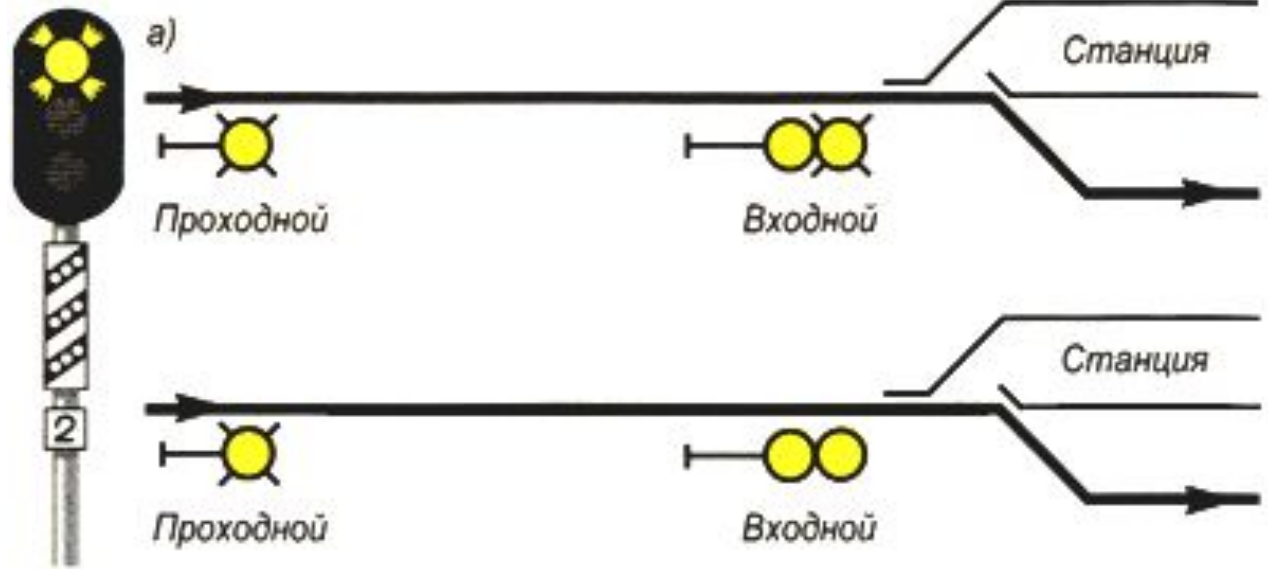

Условно-разрешающий сигнал проходного светофора

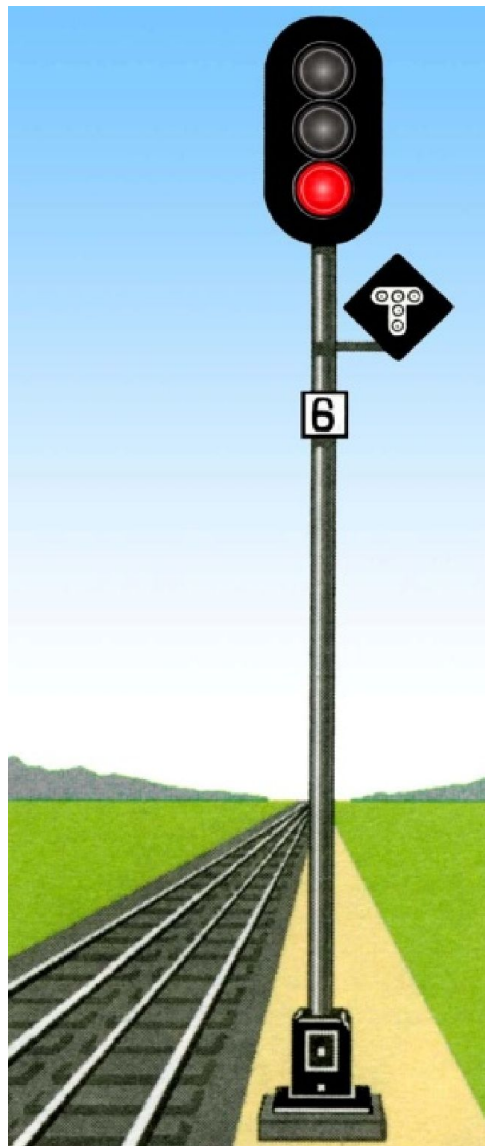
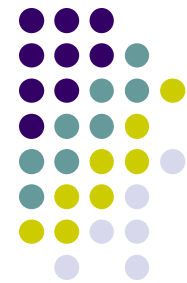

Светофоры прикрытия и заградительные

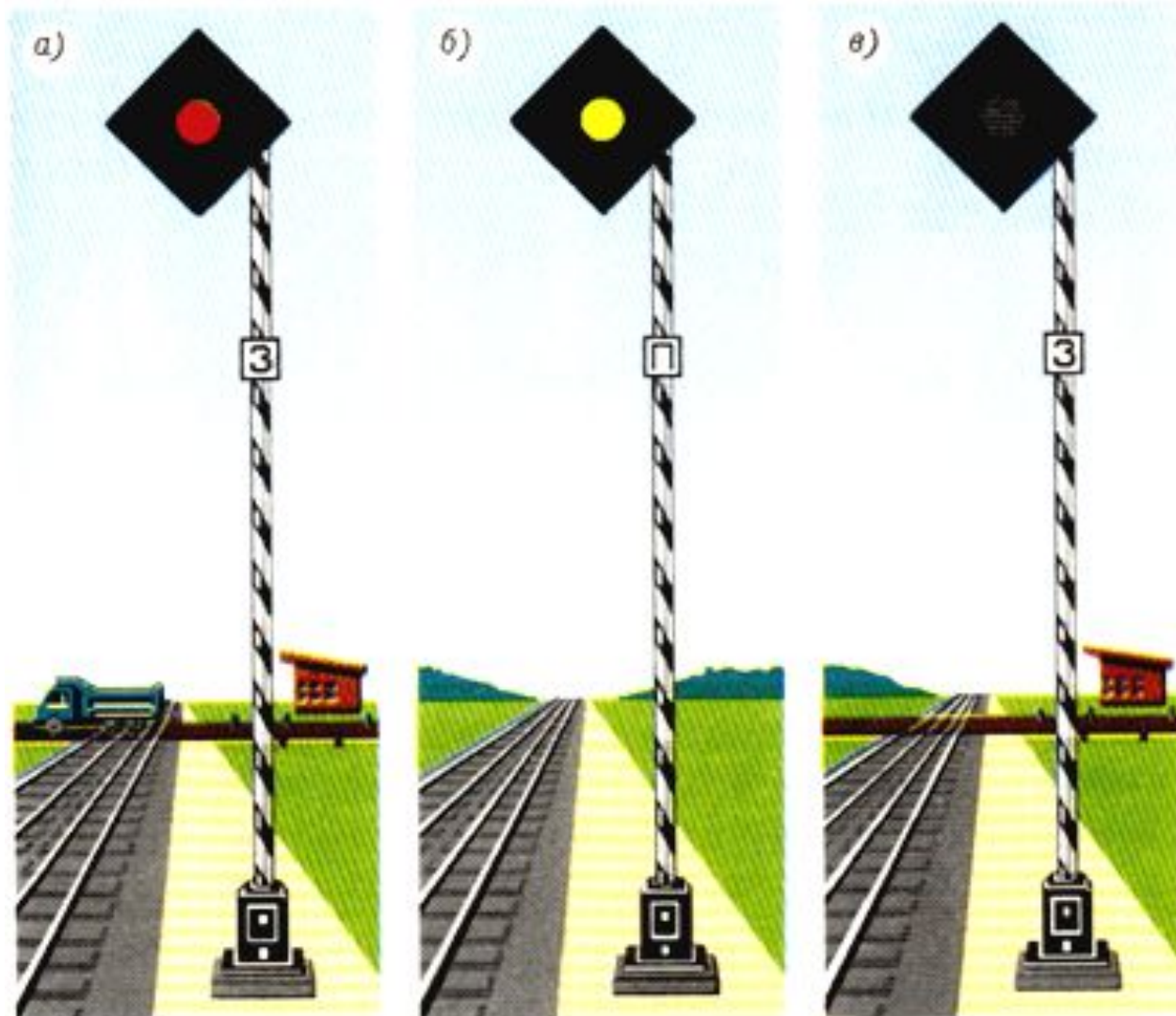

Предупредительные и повторительные светофоры

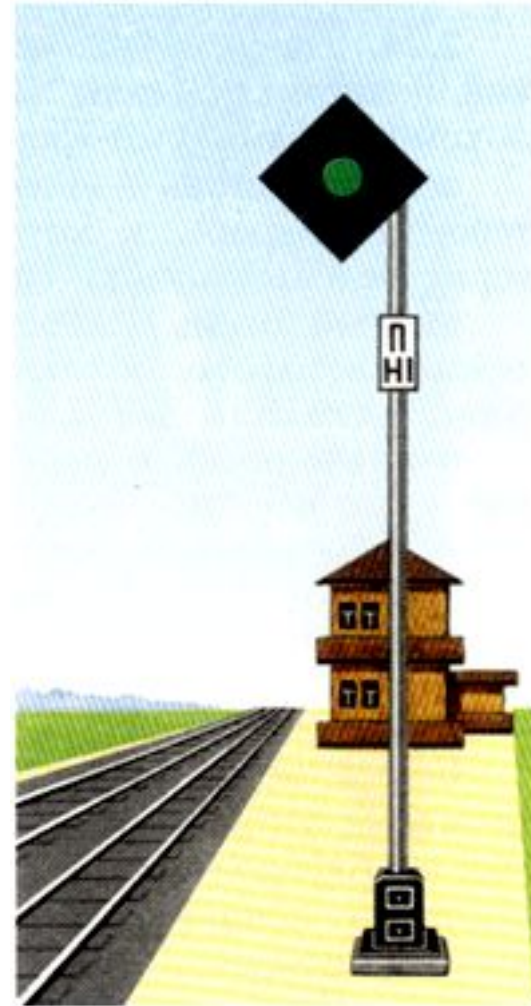
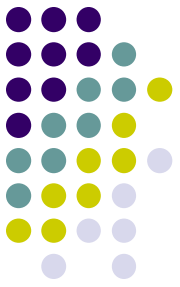

Светофоры прикрытия

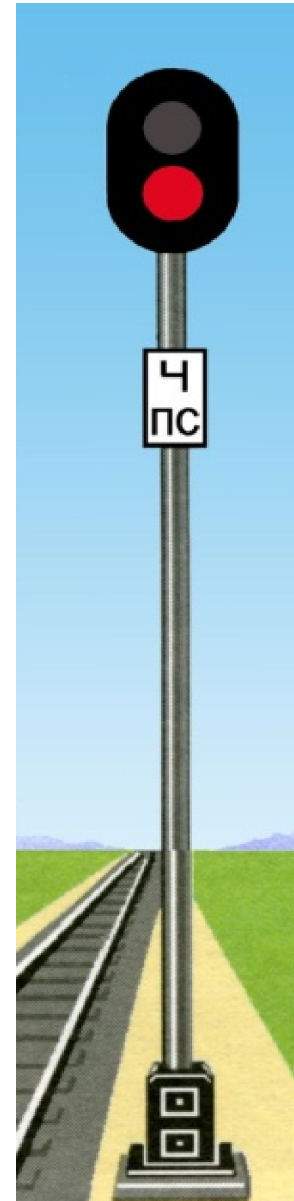
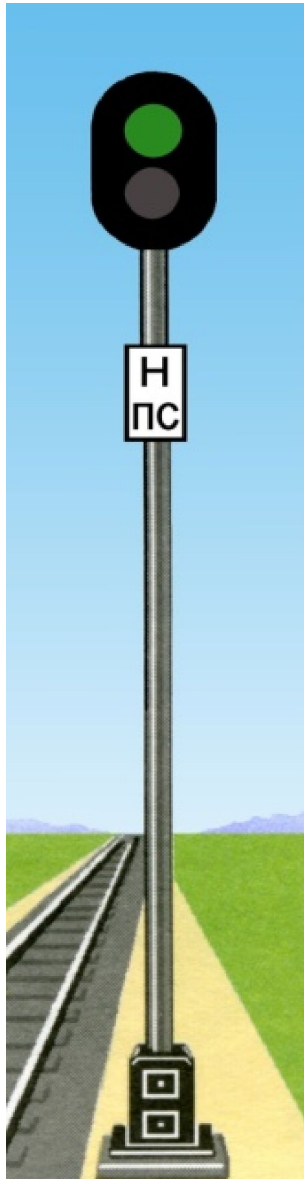

МАНЕВРОВЫЕ СВЕТОФОРЫ

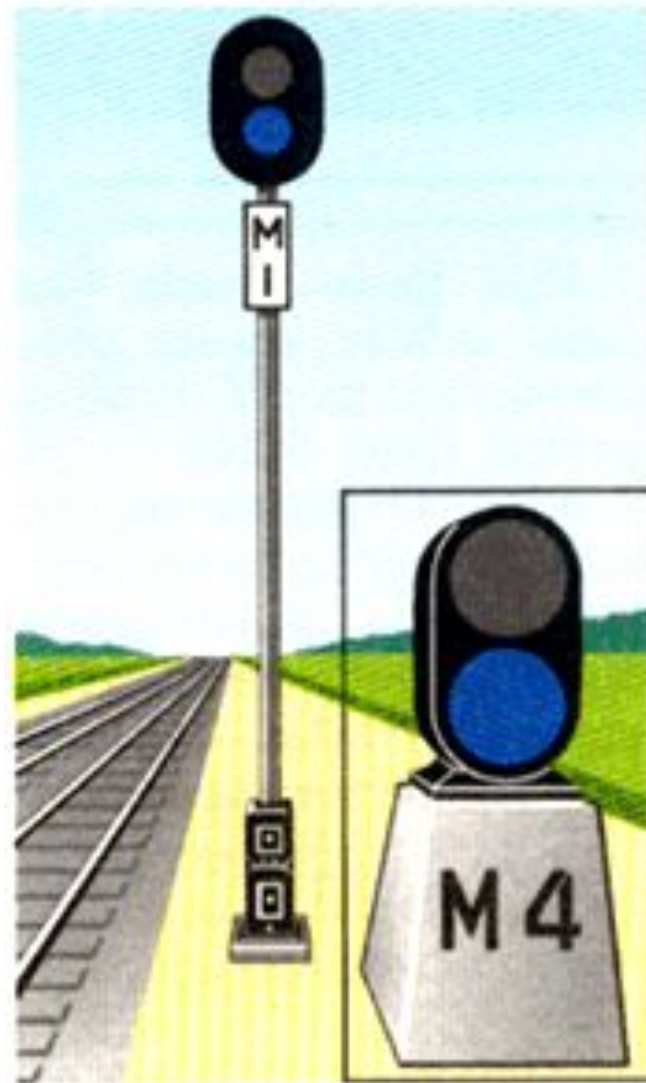
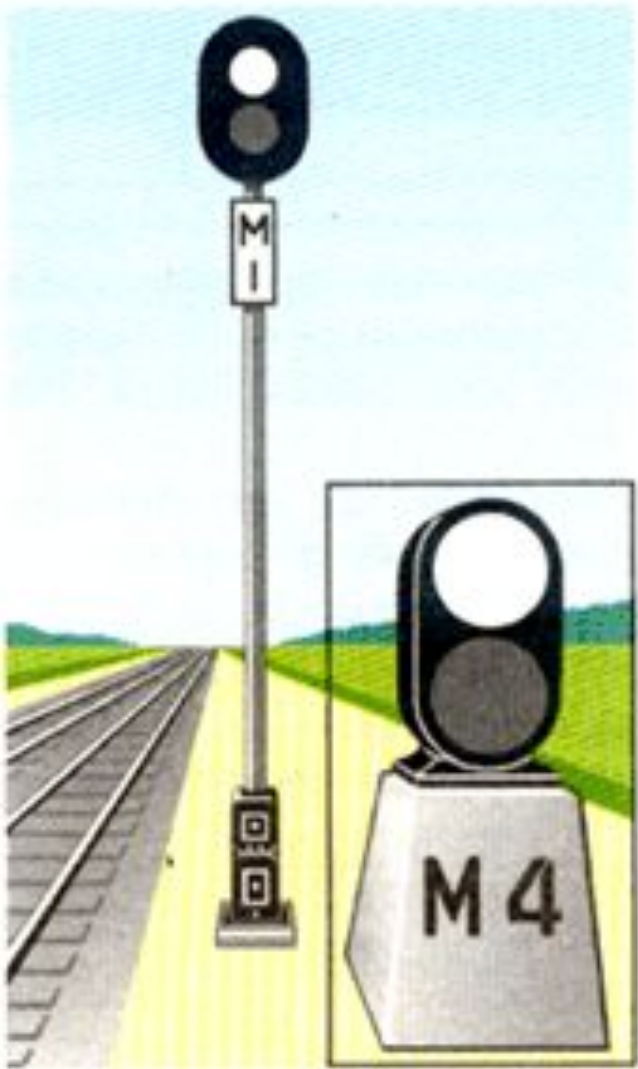

ГОРОЧНЫЕ СВЕТОФОРЫ

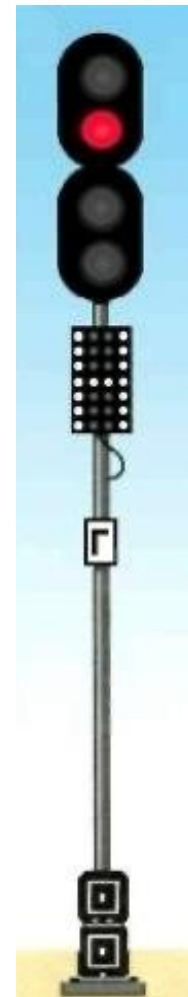
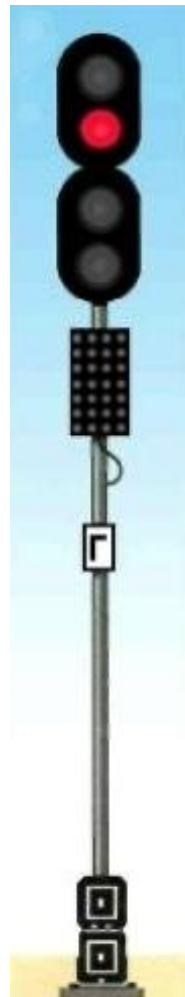
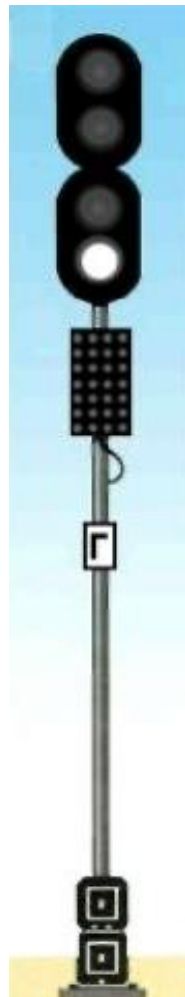
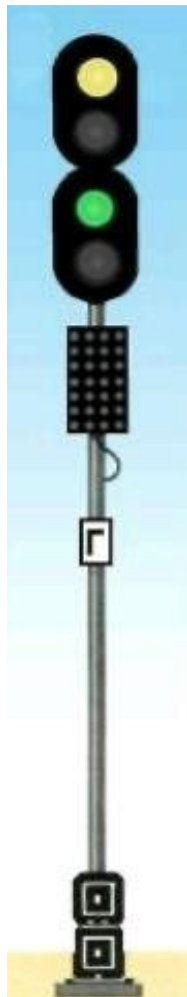
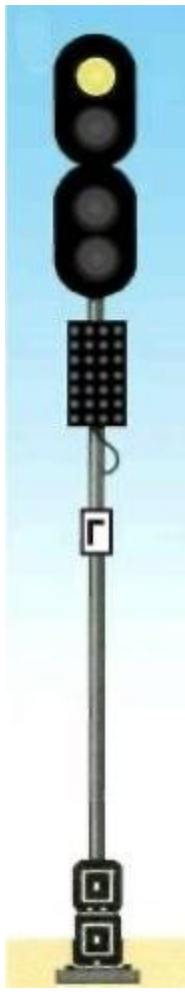
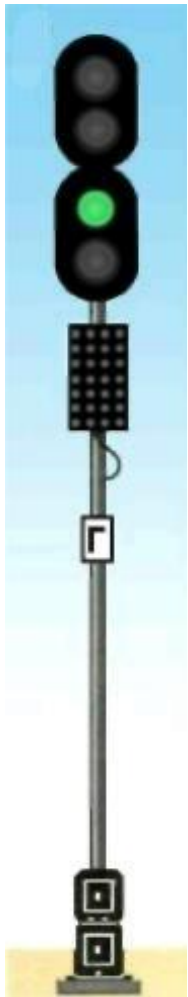
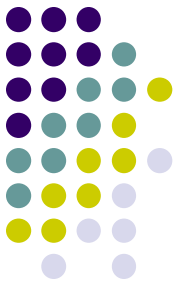

Локомотивные светофоры



Въездные (выездные) светофоры

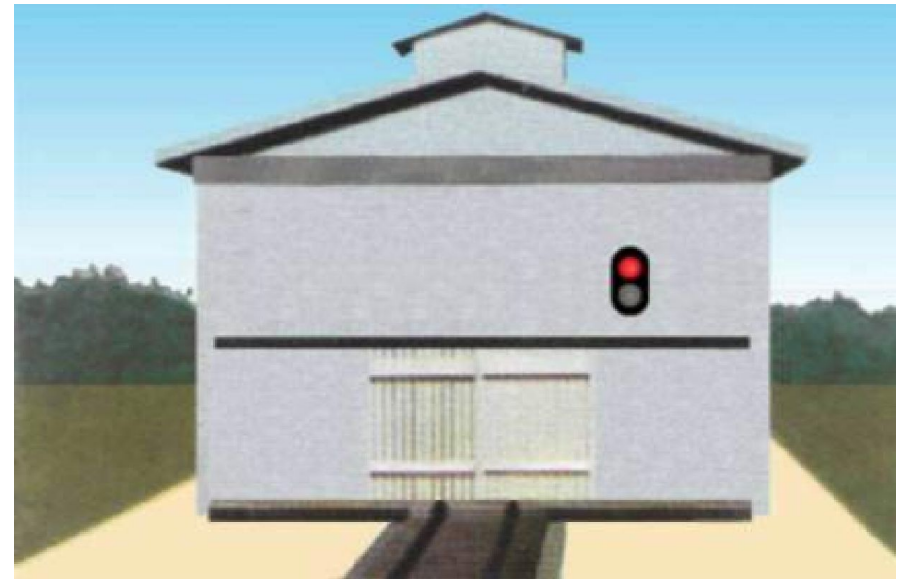
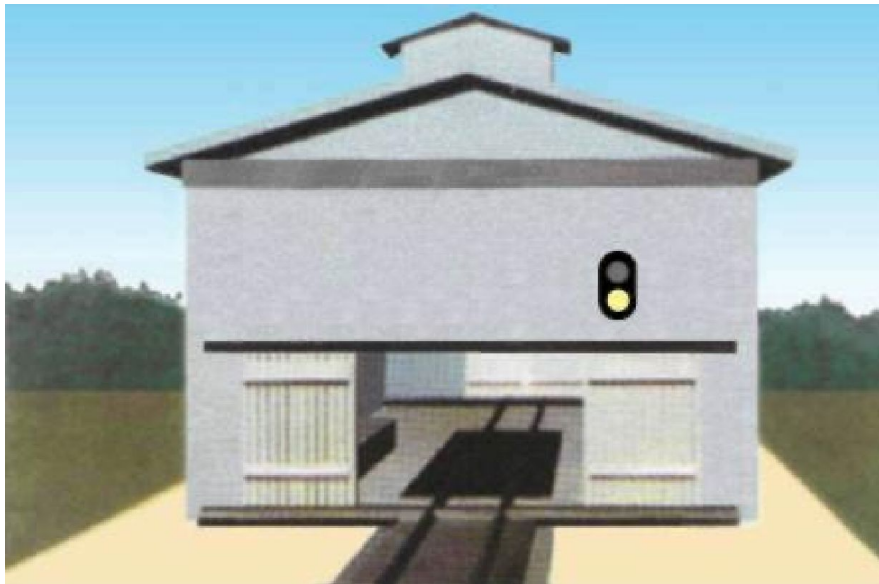
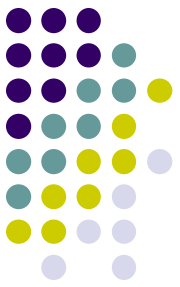

Технологические светофоры

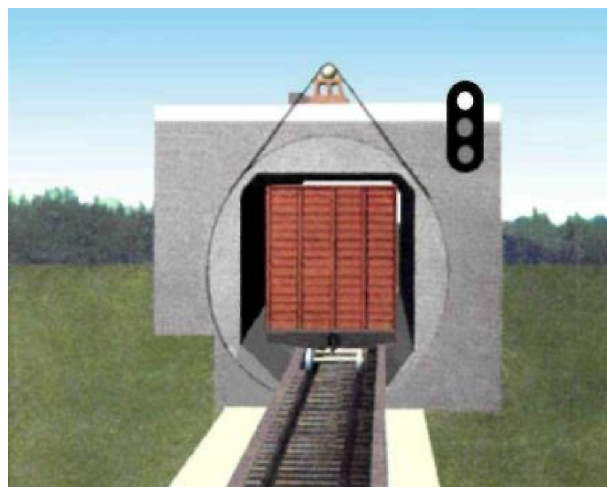
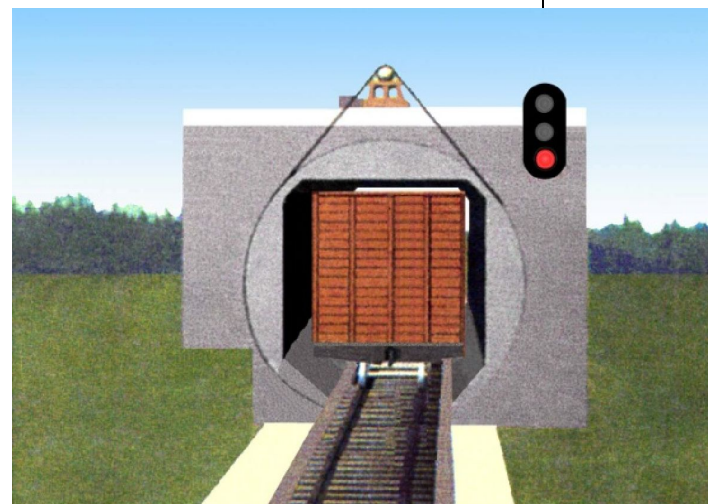
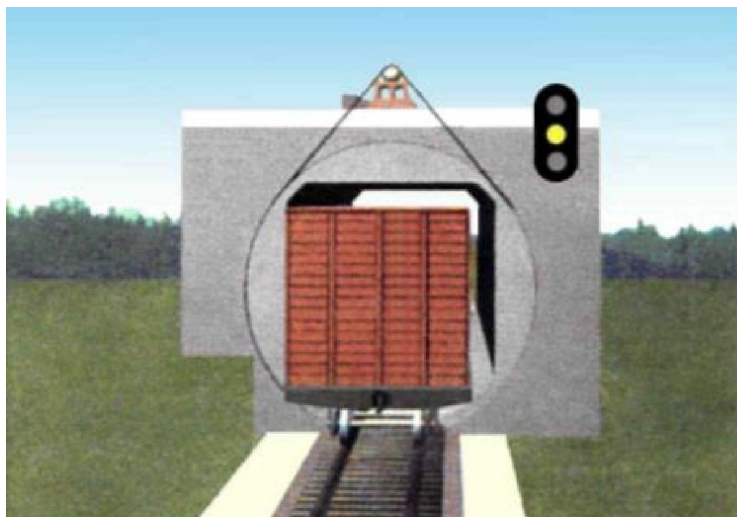

Обозначение недействующих светофоров

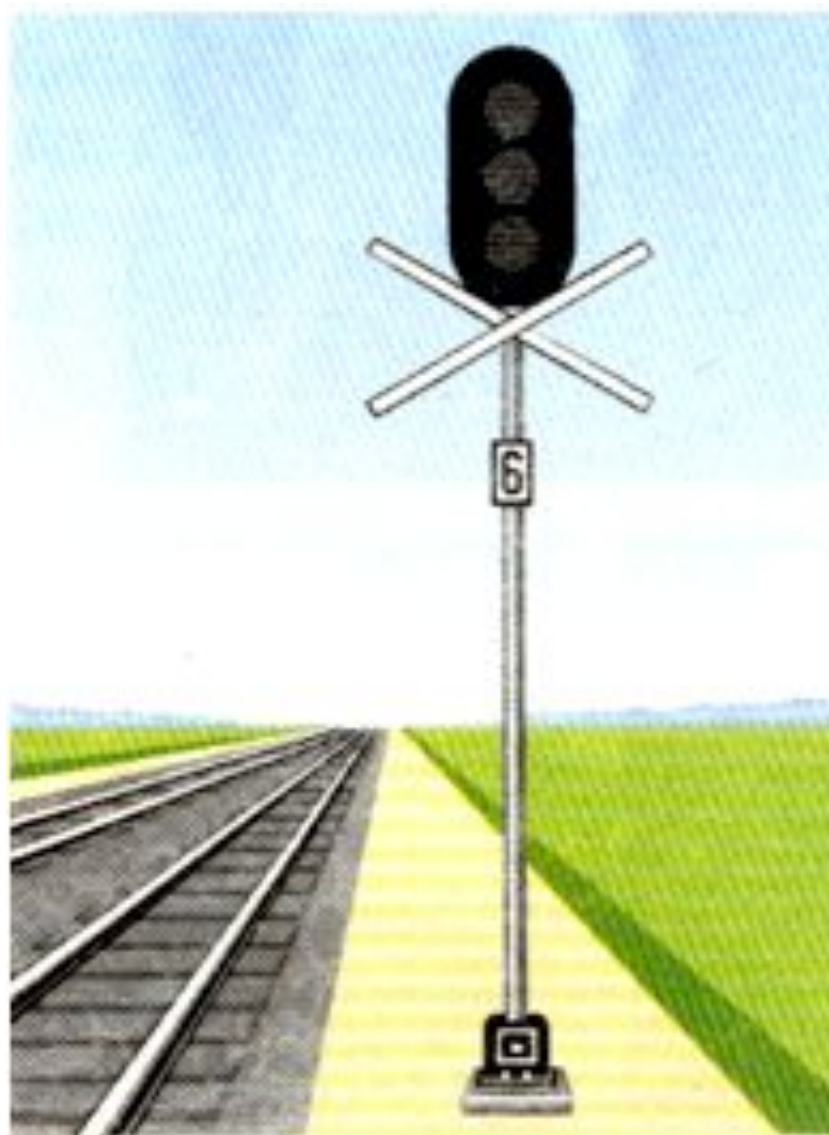
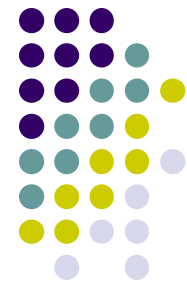

Маршрутные указатели

