

Inverter

使用说明书

Operating Instructions

AT1--Single-phase to three-phase

AT2--Single-phase to single-phase

AT3--Three-phase to three-phase

AT4--Single-phase to three-phase

AT Simple general series

High performance and low noise/

Mini AC motor driver

Charter 1 Installation and wiring

1. Main circuit terminal and function description

(1) Single-phase to three-phase (for AT1, AT4)

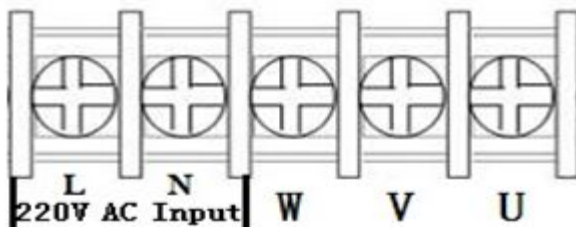

Terminal label	Function description
L, N	Single phase AC 220V input terminal
U, V, W	Output terminal connect to Three phase 220V AC motor
GND	Grounding terminal

(2) Single-phase input and output (for AT2)

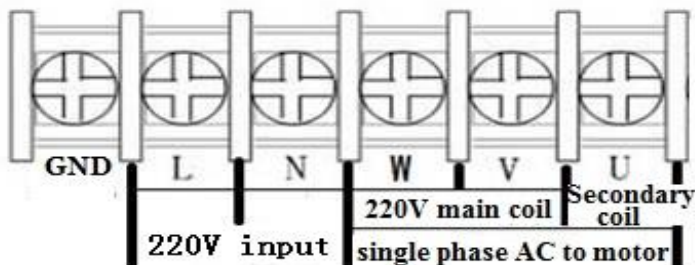

Terminal label	Function description
L, N	Single phase AC 220V input terminal
U, V, W	Output terminal connect to Single phase 220V AC motor
GND	Grounding terminal

(3). Three-phase input and output (for AT3)

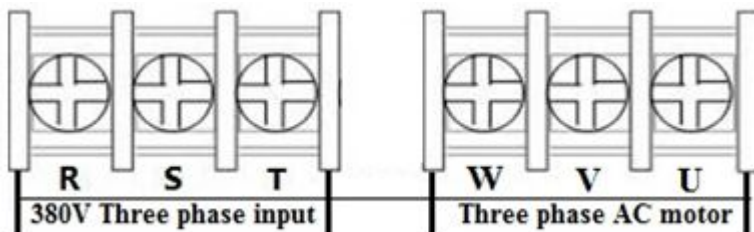

Terminal label	Function description
R,S,T	Three phase AC 380V input terminal
U, V, W	Output terminal connect to Three phase 380V AC motor
GND	Grounding terminal

2. Terminal description

Port	Functional description	Instructions
15V/24V	15V/24V power output	200mA15V/24V output
X6	Input port6 (Reversing switch)	Short Port X6 and COM, input signal effective
X5	Input port 5 (Reverse rotation Control switch)	Short Port X5 and COM, input signal effective
X4	Input port 4(Forward rotation Control switch)	Short Port X4 and COM, input signal effective
X3	Input port 3(section-speed 3)	Short Port X3 and COM, input signal effective
X2	Input port 2(section-speed 2)	Short Port X2 and COM, input signal effective
X1	Input port 1(section-speed 1)	Short Port X1 and COM, input signal effective
485+/485-	485 communication port	

Port	Functional description	Instructions
COM	Common GND	
VL1	External analog voltage input	0-5V/10V Analog voltage input
CI	External current signal input	4-20mA Current input
SP1	Open-collector output 1	
SP2	Open-collector output 2	
5V/10V	5V/10V power output	supply 5V/10V 20mA power output
TC	Relay output C	250VAC 5A/30VDC 3A TA and TB Normal Close ,TA and TC Normal Open
TB	Relay output B	
TA	Relay output A	

3. Multi-speed input Frequency control table :

	Section speed input 1	Section speed input 2	Section speed input 3	Original Frequency
Main Speed	1	1	1	50
Section speed 1	1	1	0	45
Section speed 2	1	0	1	40
Section speed 3	1	0	0	35
Section speed 4	0	1	1	30
Section speed 5	0	1	0	25
Section speed 6	0	0	1	20
Section speed 7	1	1	1	15
Note:	0 means input Port connect with COM, 1 means disconnect.			

4. Basic operation wiring diagram

(1) Single-phase input three-phase output (for AT1)

(Three phase 220V, if 380V Star-connection method needs to change to the **220V Delta-connection** method)

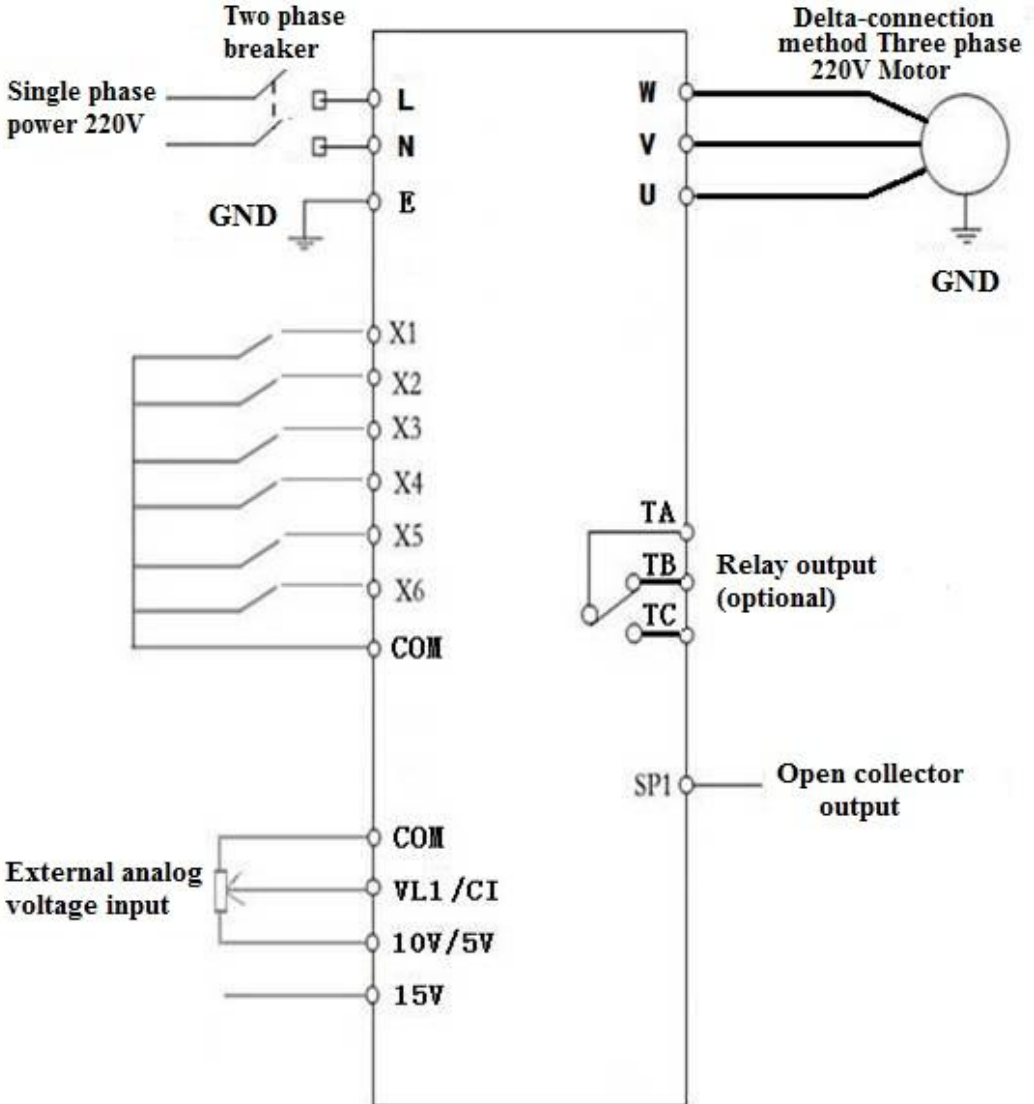

(2). Single-phase input and output (for AT2) (220V single phase motor, Non-removed capacitor / Removed capacitor)

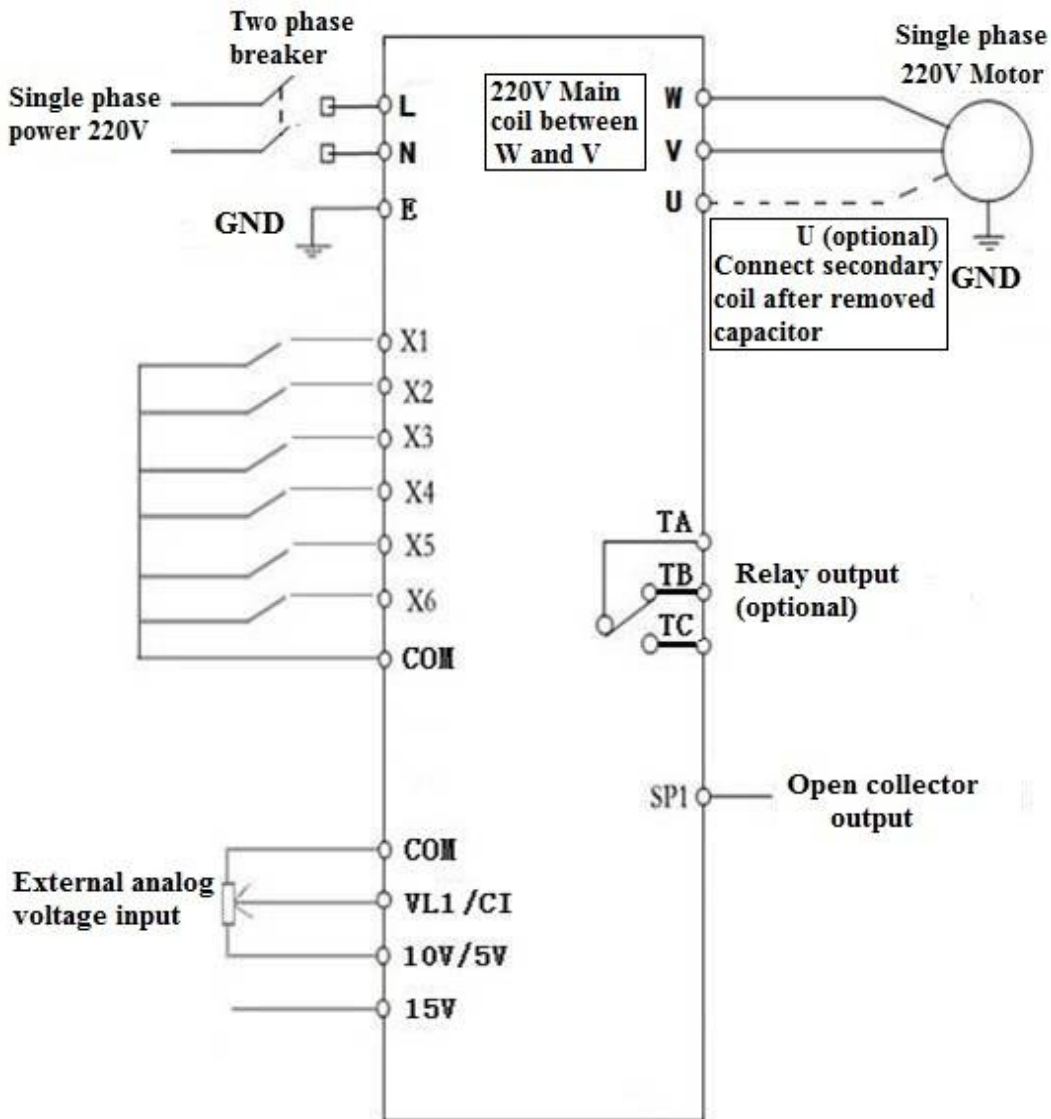

(3). Three-phase input and output (for AT3)

(380V three phase input, connect with 380V three phase motor)

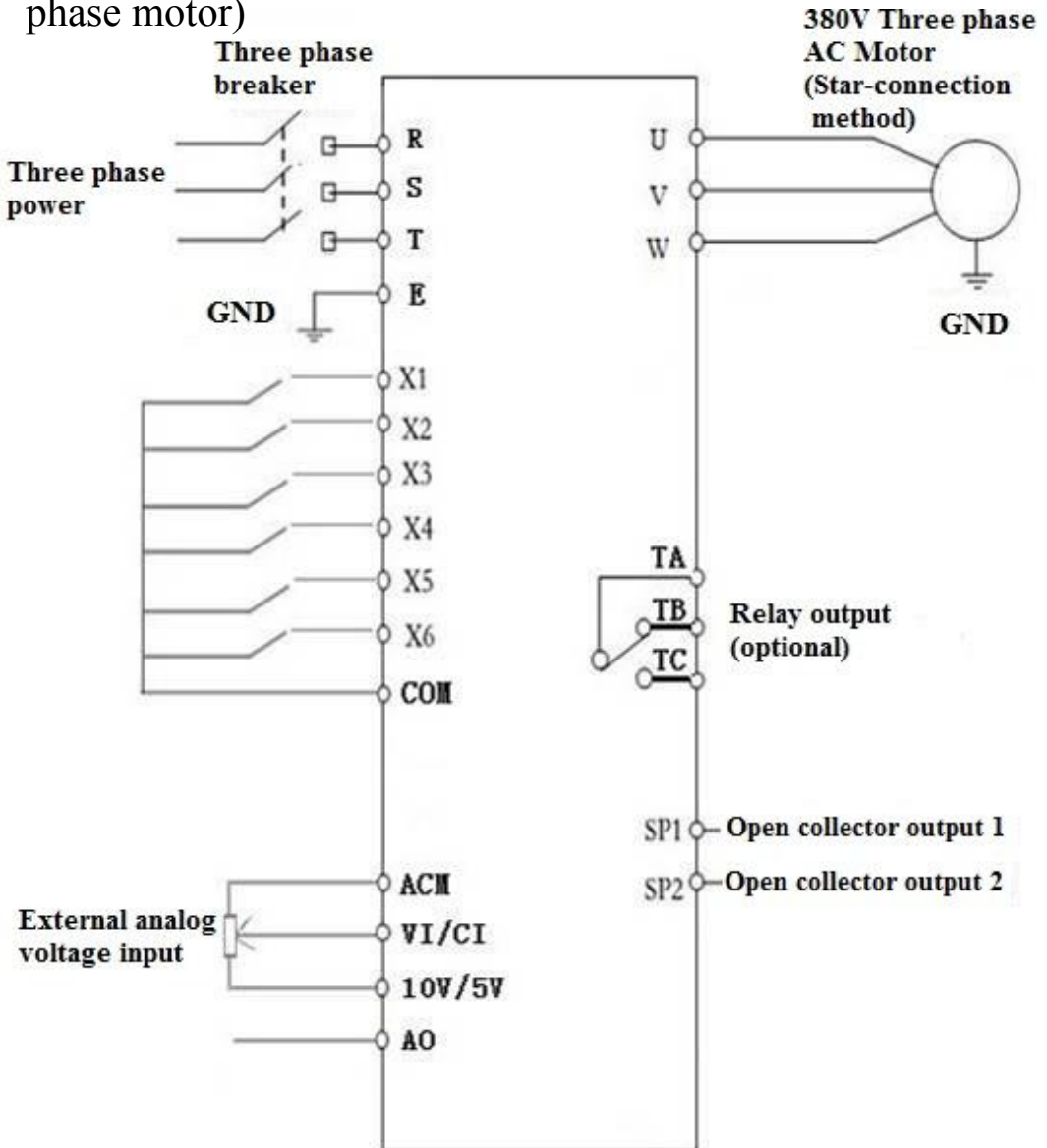

5. Operation panel

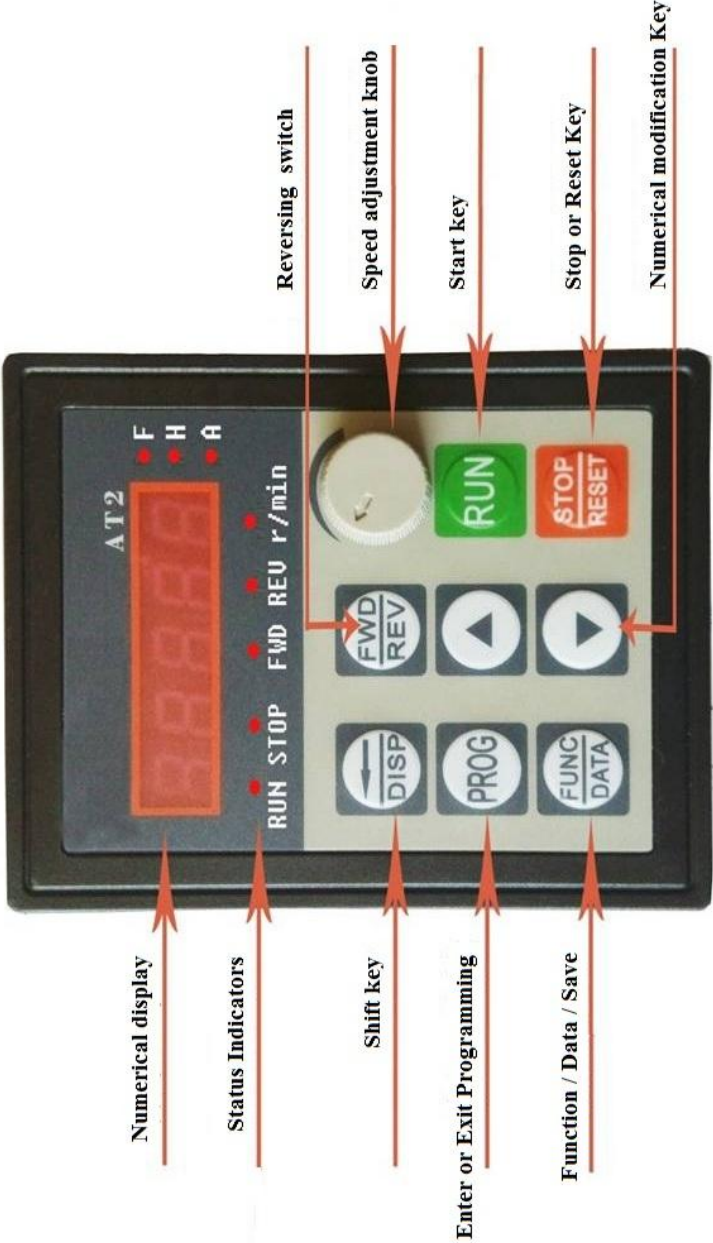

Note: "r/min": Revolution per minute

- "F": Frequency setting
- "H": Operating frequency
- "A": Operating current

6. Keys instructions :

	Icon	Function description	
1	(Programming)	For selecting mode or Programming mode (it is available not mater the Inverter start or stop), press this key for modifying parameters.	
2	(Function / Save)	Function data setting key. Normal mode: press this key to display the information of the Inverter, such as target frequency, output frequency and current, temperature;	
3	Key (▲)	Parameter number or parameter value increase	Short press this key, then the numerical value will change gradually. Long press this key, then the numerical value will change rapidly
4	Key (▼)	Parameter number or parameter value decrease	
5	Shift	Shift in programming mode, jog in normal mode	
6	Forward / Reverse	Forward / Reverse switching key	
7	Start	Start Inverter output	
8	Stop / Reset	Break down, fault resetting	
Note	Please modify the parameters under the stop state, otherwise the changed parameters cannot be saved.		

Chapter 2 Parameter specification

1. Parameter specification

Parameter	Parameter specification	Parameter range	Default	Unit
P00	Maximum voltage	0---220.0/380.0	220/380	V
P01	Reference frequency	0---400.0	50	Hz
P02	Intermediate voltage	0---220.0/380.0	110/190	V
P03	Intermediate frequency	0---400.0	25	Hz
P04	Minimum voltage	0---220.0/380.0	0	V
P05	Minimum frequency	0---400.0	0	Hz
P06	Maximum operating	0---400.0	100	Hz
P07	Minimum operating	0---400.0	0	Hz
P08	Hide password	0---65535	33333	
P09	Input password	0---65535	0	
P10	Working frequency source	0: Panel keyboard; 1: Panel potentiometer; 2: External analog signal 3: RS485.	1	
P11	Start/stop control source	0: Panel keyboard; 1: RS485; 2: External port.	0	

P12	Stopping Modes	0: Inertial stop; 1: Deceleration stop; 2: Brake stop; 3: Emergency brake.	1	
P13	Braking time	0---2.5	0.5	S
P14	Braked Voltage	0---140.0	20	V
P17	Machine number	1-255	1	
P18	Operating arrival	0---100.0	50	Hz
P20	Over temperature protection selection	1---80	80	
P21	Revolution for 50Hz	0-8000	2800	
P22	Carrier setting	1---10 (1-20 for High Ver)	10	
P23	Frequency adjusting step size	1---100	5	0.1Hz
P24	Overload protection buffer time	0.1---60.0	3	S
P26	Working frequency	0---400.0	50	Hz
P27	Section speed 1 setting	0---400.0	45	Hz
P28	Section speed 2 setting	0---400.0	40	Hz
P29	Section speed 3 setting	0---400.0	35	Hz
P30	Section speed 4 setting	0---400.0	30	Hz
P31	Section speed 5 setting	0---400.0	25	Hz
P32	Section speed 6 setting	0---400.0	20	Hz

P33	Section speed 7 setting	0---400.0	15	Hz
P34	Main rising velocity	1---1000	50	Hz/S
P35	1st rising velocity	1---1000	50	Hz/S
P36	2nd rising velocity	1---1000	50	Hz/S
P37	3rd rising velocity	1---1000	50	Hz/S
P38	4th rising velocity	1---1000	50	Hz/S
P39	5th rising velocity	1---1000	50	Hz/S
P40	6th rising velocity	1---1000	50	Hz/S
P41	7th rising velocity	1---1000	50	Hz/S
P42	Main descent velocity	1---1000	25	Hz/S
P43	1st descent velocity	1---1000	50	Hz/S
P44	2nd descent velocity	1---1000	50	Hz/S
P45	3rd descent velocity	1---1000	50	Hz/S
P46	4th descent velocity	1---1000	50	Hz/S
P47	5th descent velocity	1---1000	50	Hz/S
P48	6th descent velocity	1---1000	50	Hz/S
P49	7th descent velocity	1---1000	50	Hz/S
P50	Multi function input 1 (X1 binding post)	0: invalid, terminal is non-functioning 1: wire control stop 2: keying stop; 3: keying operation; 4: stop keying;		

P50	Multi function input 1 (X1 binding post)	5: wire forward operation 6: wire reverse operation; 7: reservation 8: error reset signal; 9: wire reversing switch; 10: keying forward switching; 11: keying forward switching; 12: reverse switch keying; 13: section speed input 1; 14: section speed input 2; 15: section speed input 3; 16: external error signal.	13	
P51	Multi function input 2	17: Jog Forward;	14	
P52	Multi function input 3	18: Jog Reverse;	15	
P53	Multi function input 4	19: Emergency stop;	5	
P54	Multi function input 5	20: Relay Control.	6	
P55	Multi function input 6		9	
P58	Multi function input 1 (SP1)	0: invalid, no output; 1: operating instructions; 2: set arrival instructions 3: fault indication; 5: Emergency stop; 6: For P50-P55=20;	0	
P60	Multi function input 2	Idem (Relay output)	0	
P62	Display options	0: setting frequency; 1: operating frequency; 2: revolution 3: current; 4: temperature; 5: time;	0	

P65	Power on options	0: normal power on; 1: report error with start signal when power on; 2: Power on forward; 3: Power on reverse.	0	
P66	Input stabilization time	0---65535	60	mS
P67	Voltage coefficient	0---65535	28500	
P68	Under voltage setting	0---220/380	60/180	V
P69	Overvoltage setting	220.0---400/680	400/600	V
P70	Torque compensation options	0: P72 is compensation amount; 1: Multiply P72 by P71 after P71 minus input voltage	0	
P71	Torque compensation voltage	0---300.0	10	V
P72	Torque compensation setting	0---100	0	
P73	Maximum external analog	0---65535	31440	
P74	Minimum external analog	0---65535	2096	
P75	Zero current compensation value	0---65535	1130	
P76	Current coefficient	0---65535	9500	
P77	Parameter reset	0---65535 (It is the reset when 54321)	0	
P86	Jog forward frequency	0---400.0	20	Hz
P87	Jog reverse frequency	0---400.0	20	Hz
P88	Jog rising velocity	1---1000	50	Hz/S
P89	Jog descent velocity	1---1000	50	Hz/S

P90	Jog stopping modes	0: Inertia stop; 1: Decelerate stop; 2: Braking stop; 3: Emergency brake.	1	
P91	Jog braking time	0---2.5	0.1	S
P127	Remaining hours	0---65535	65535	H

2. Parameter setting password and Down time

stop:

P08 is the hidden password, it always shows only 00000, not the actual value.

When input the value of P09=the hidden value of P08, the P08 shows hidden value, and the P08 and other parameters can be changed. The P09 will be nullified when unplug the power cable to restart.

When P127=65535, the function of countdown do not start.

When P127 < 65535, the function of countdown will start, the P127 will minus 1 when the Inverter runs for one hour. The frequency converter will be stopped when the countdown of P127 to 0 hour.

4. Parameter setting procedure:

1. Press the programming key to enter into the programming state;
2. Use the arrow keys and shift key to find the parameters that need to be modified;
3. Press function / save key to enter into the parameter;
4. Use the arrow keys and shift key to amend the parameter value;
5. Press the function / save key to store the parameter;
6. Press the programming key to exit the programming state.

Chapter 4 Fault Code

Fault Code Display	Fault Code Description
Err 1	Short Circuit/Current overload/Power Module protection
Err 2	Undervoltage protection
Err 3	Overvoltage protection
Err 4	Driving Circuit Failures
Err 5	Input at startup when electrified
Err 6	Over current protection
Err 7	Overtime
Err 8	Excessive temperatures for radiator
Err 9	External fault