

# **POLO**

# **Maintenance Instruction**

# TABLE OF CONTENTS

1 about POLO

2 Distribution of the main board components

2.1 TOP

2.2 BOTTOM

3 Baseband

3.1 System block Diagram

3.2 Power management

3.2.1 Block Diagram

3.2.2 Power list

**4 Reference for maintenance**

4.1 No power on

4.2 Download fail

4.3 Audio

4.3.1 No ring

4.3.2 No receiving voice

4.3.3 Speaker echo

4.3.4 No sending voice

4.3.5 Earphone detect fail

4.3.6 Earphone inefficacy

- 4.4 No vibration
- 4.5 No charge
- 4.6 Camera inefficacy
- 4.7 LCD
  - 4.7.1 LCD display wrong
  - 4.7.2 LCD backlight inefficacy
- 4.8 Bluetooth
  - 4.8.1 power on fail
  - 4.8.2 Connect fail/bad voice
- 4.9 WIFI inefficacy
- 4.10 FM inefficacy
- 4.11 Key NG
- 4.12 KEY LED NG
- 4.13 Sensor
  - 4.13.1 proximity sensor NG
  - 4.13.2 Gsensor NG
- 4.14 SIM card inefficacy
- 4.15 TF card inefficacy
- 4.16 GPS inefficacy
- 4.17 TP inefficacy

## 1 . About POLO

POLO is based on MTK MT6577 platform designed Smartphone.  
Support all main functions like WIFI/GPS/BT/FM/CTP and so on.



## 2.2 BOTTOM

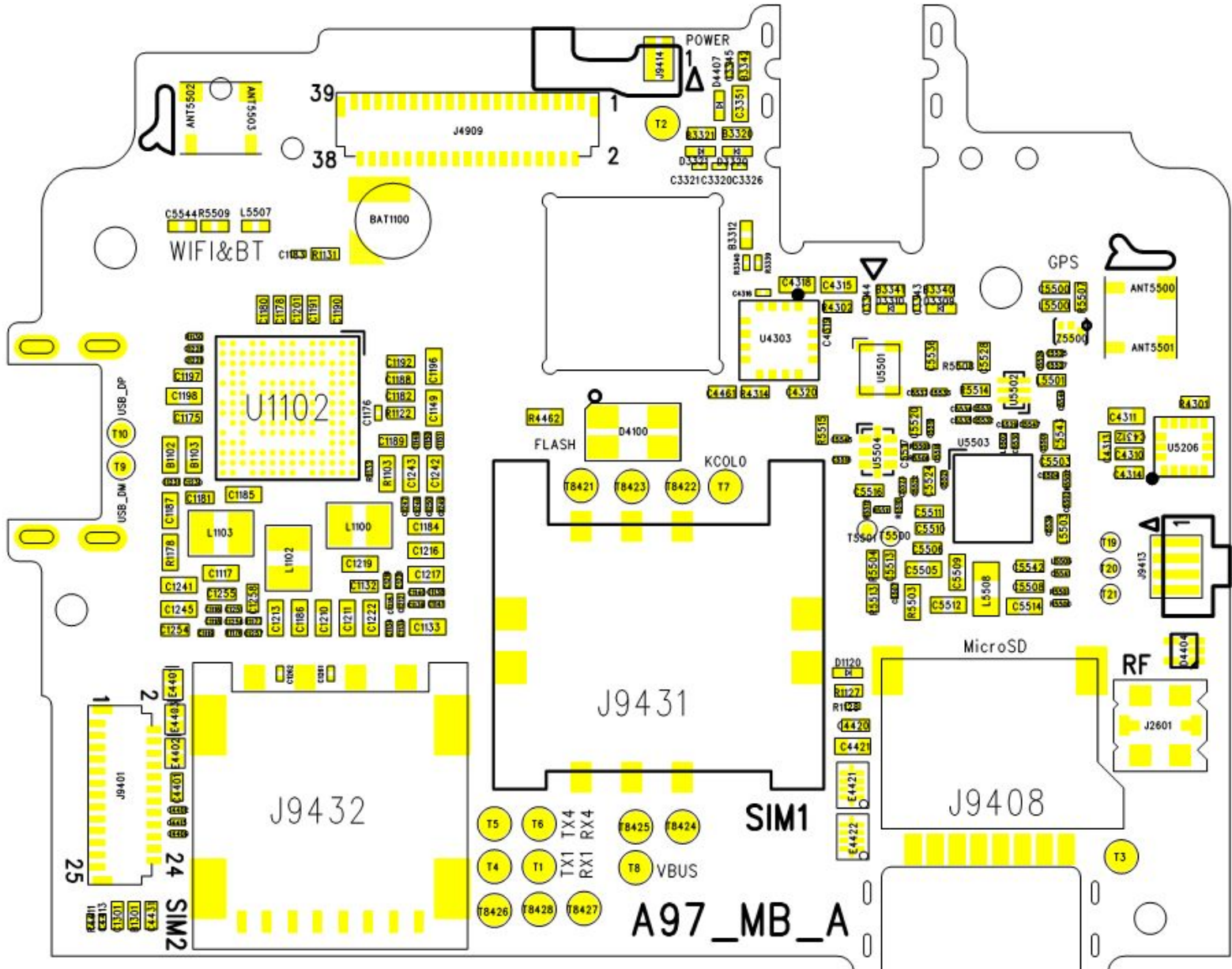

# 3 Baseband

## 3.1 System block Diagram

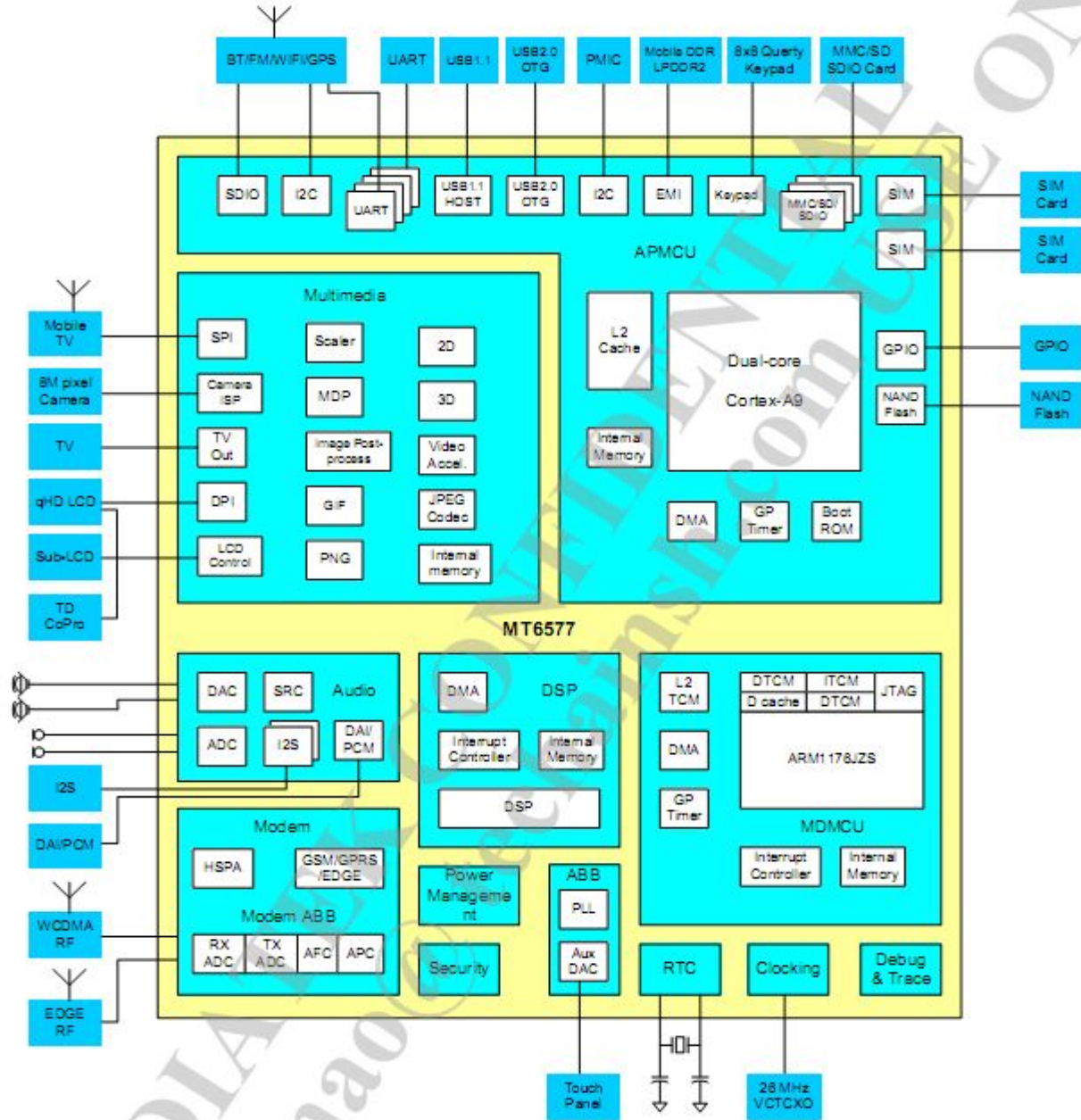



## 3.2 Power management

### 3.2.1 power management Block Diagram

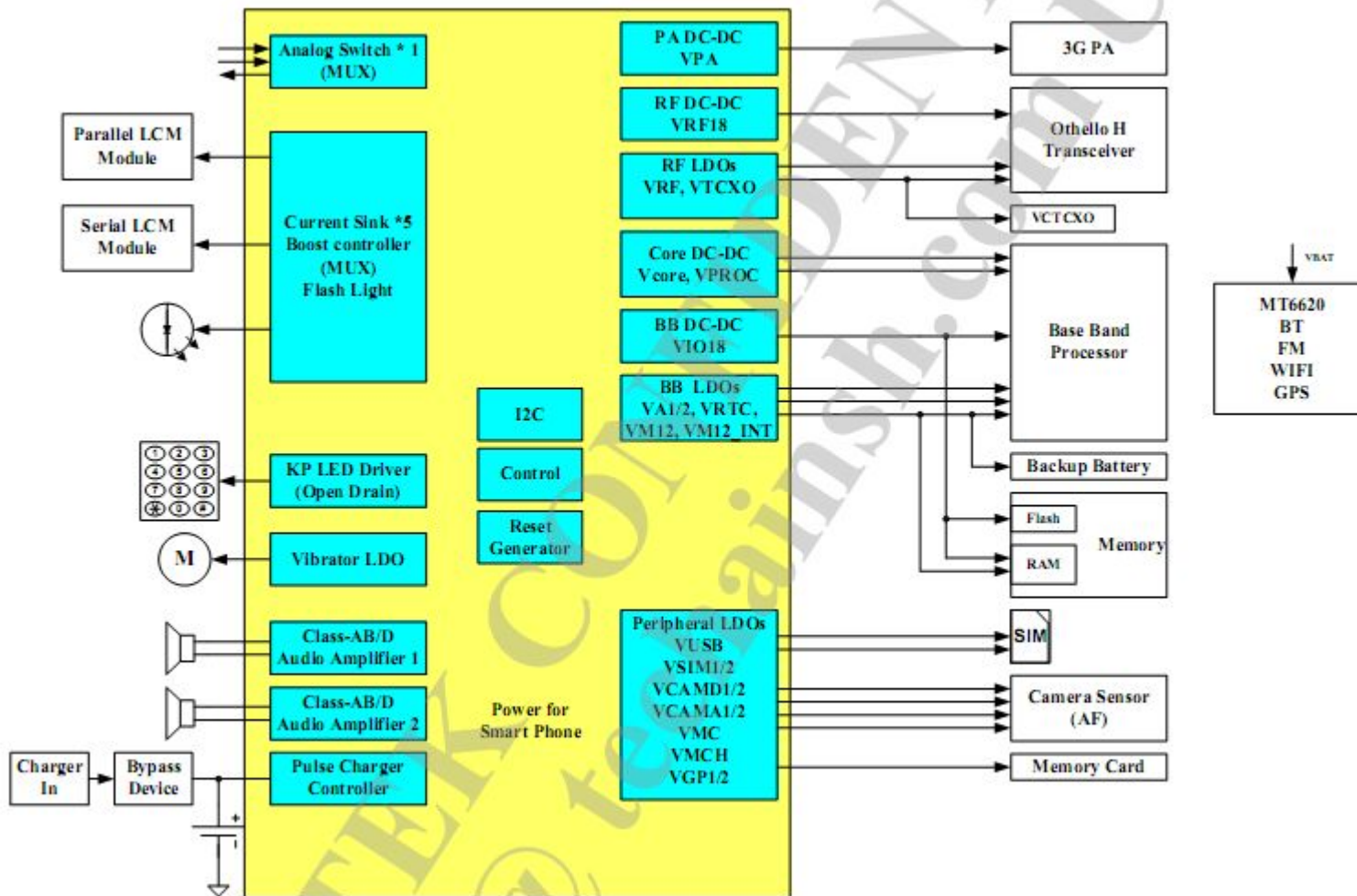



# MT6329 Power List

	Symbol	V <sub>out</sub> (V)	I <sub>out</sub> (mA)
Buck	VPA	0.9 ~ 3.4 (100mV/step)	800
	VPROC	0.75 ~ 1.3 (25mV/step)	1500
	VRF1B	1.825	250
	VCDRE	0.75 ~ 1.3 (25mV/step)	1000
	VIO1B	1.8	1000
Analog LDO	VRF2B	2.85	200
	VTCXO	2.8	40
	VCAMA	1.5/1.6/2.5/2.8	200
Digital LDO	VA1	1.8/2.0/2.1/2.5	100
	VA2	2.5/2.8	100
	VM12_1	1.2	300
	VM12_2	1.2	300
	VM12_INT	1.2	300
	VIO2B	2.8	100
	VSIM1	1.8/3.0	100
	VSIM2	1.3/1.5/1.8/2.5/2.8/3.0/3.3	100
	VUSB	3.3	100
	VCAMD	1.2/1.3/1.5/1.8/2.5/2.8/3.0/3.3	300
	VCAM_IO	1.3/1.5/1.8/2.5/2.8/3.0/3.3	100
	VCAM_AF	1.3/1.5/1.8/2.5/2.8/3.0/3.3	200
	VMC	1.3/1.5/1.8/2.5/2.8/3.0/3.3	200
	VMCH	1.3/1.5/1.8/2.5/2.8/3.0/3.3	400
	VGP	1.3/1.5/1.8/2.5/2.8/3.0/3.3	100
	VGP2	1.3/1.5/1.8/2.5/2.8/3.0/3.3	100
	Vibrator	VIBR	1.3/1.5/1.8/2.5/2.8/3.0/3.3
RTC	VRTC	1.8/2.0/2.1/2.8	2

## 4 Reference for maintenance

### 4.1 No power on

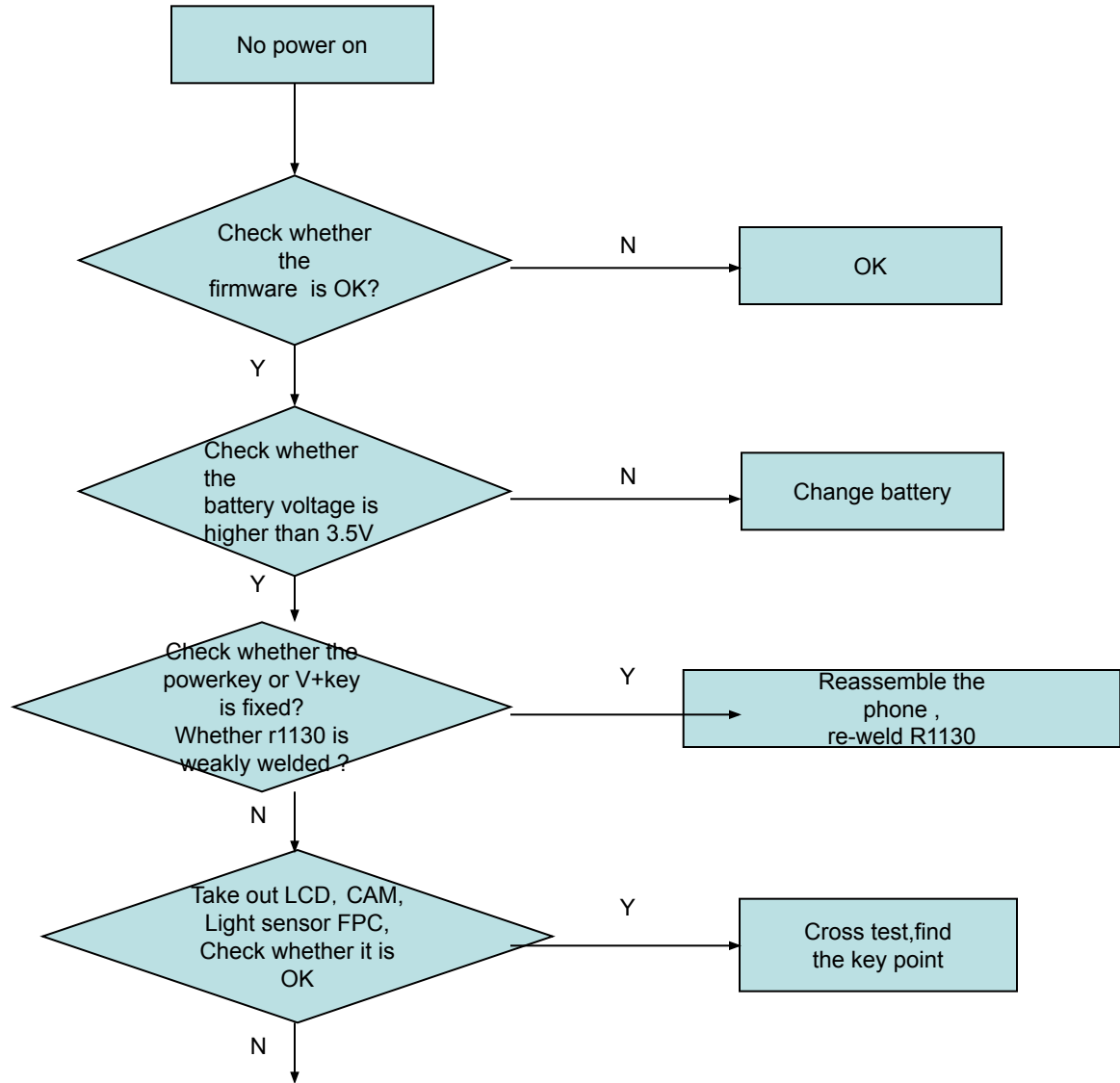

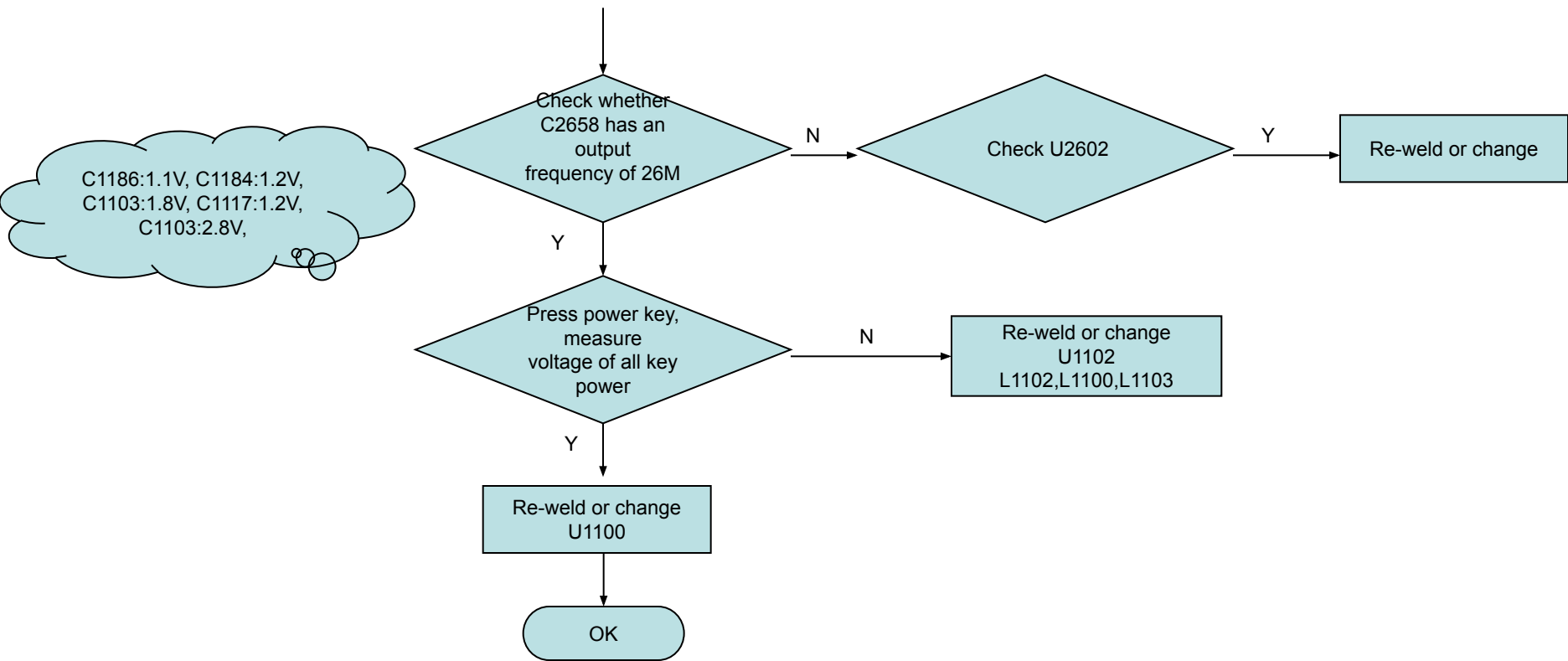

## 4.2 Download fail

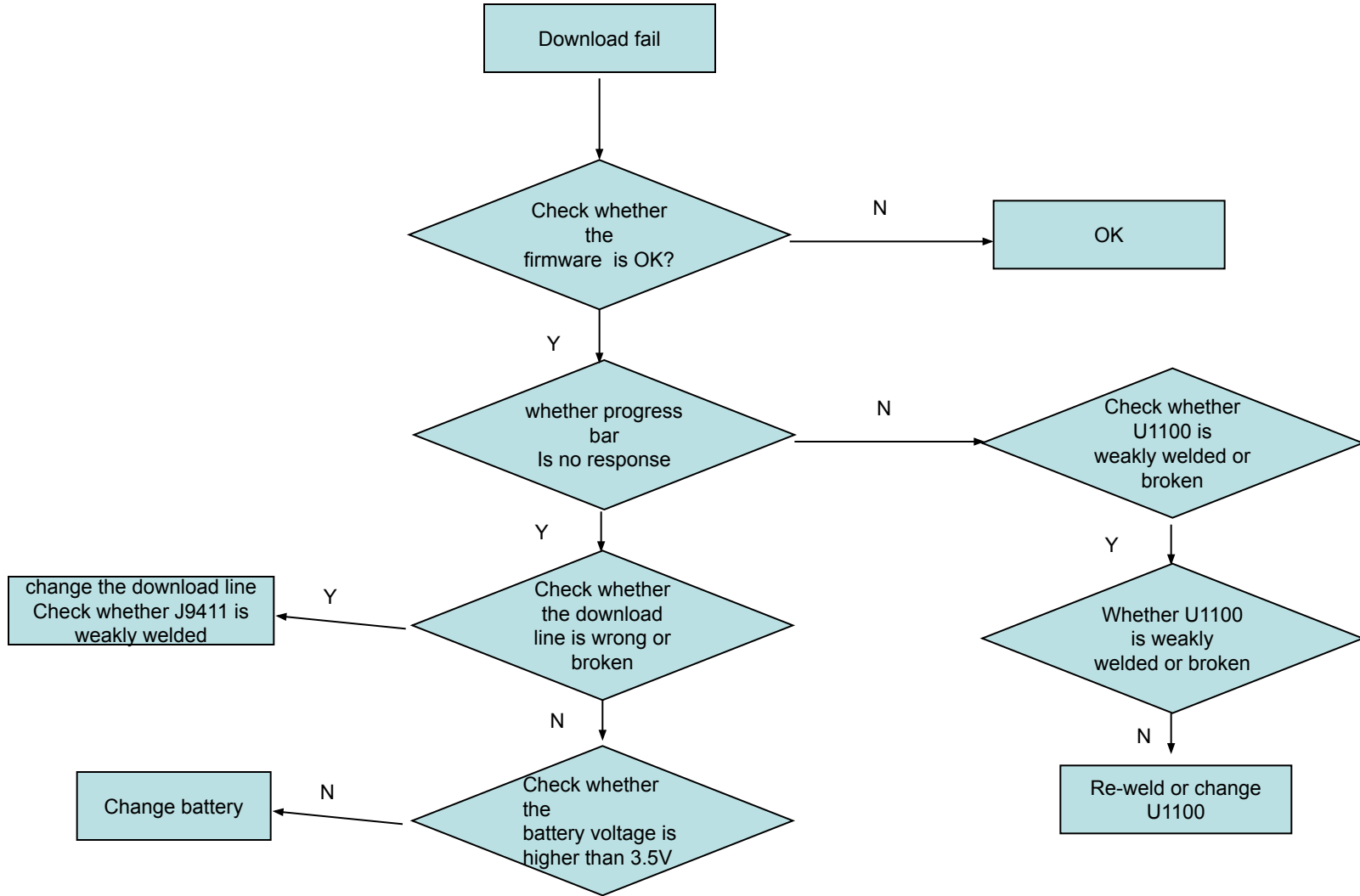

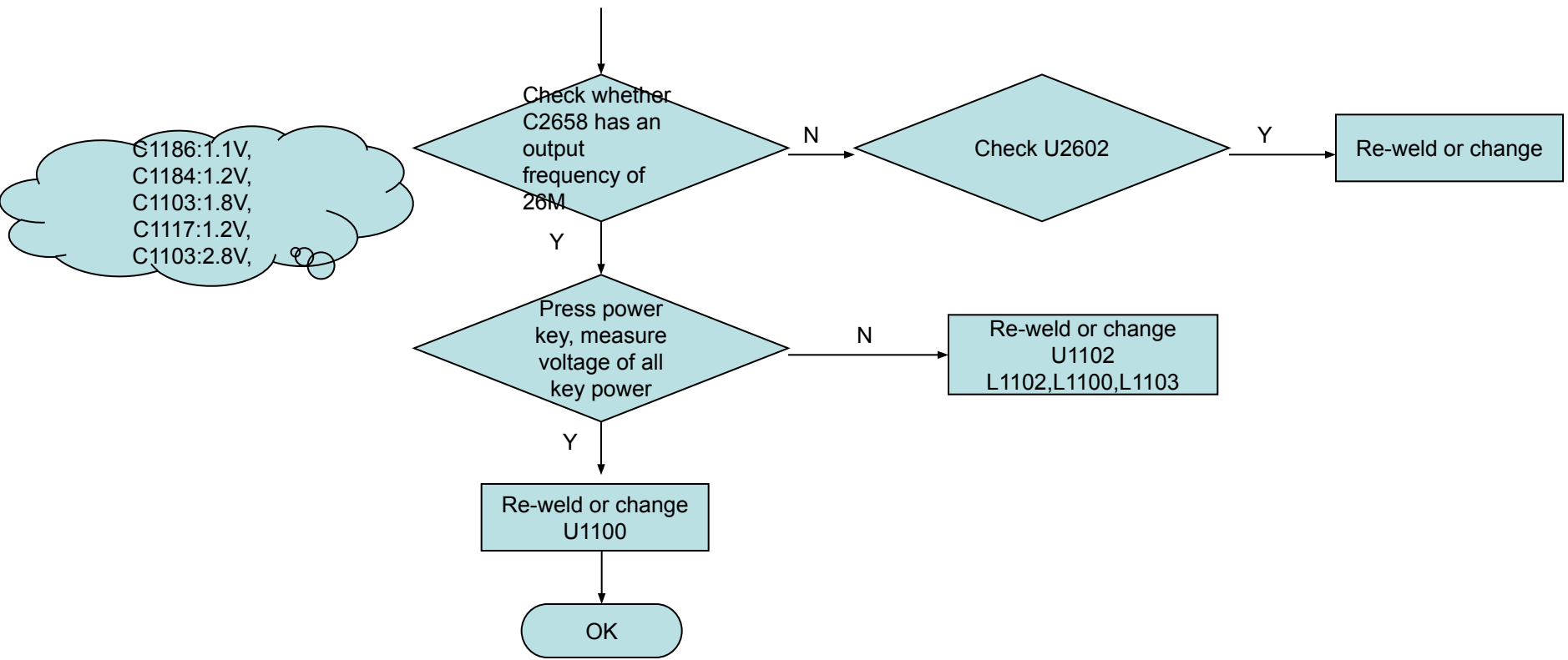

#### 4.3.1 No ring

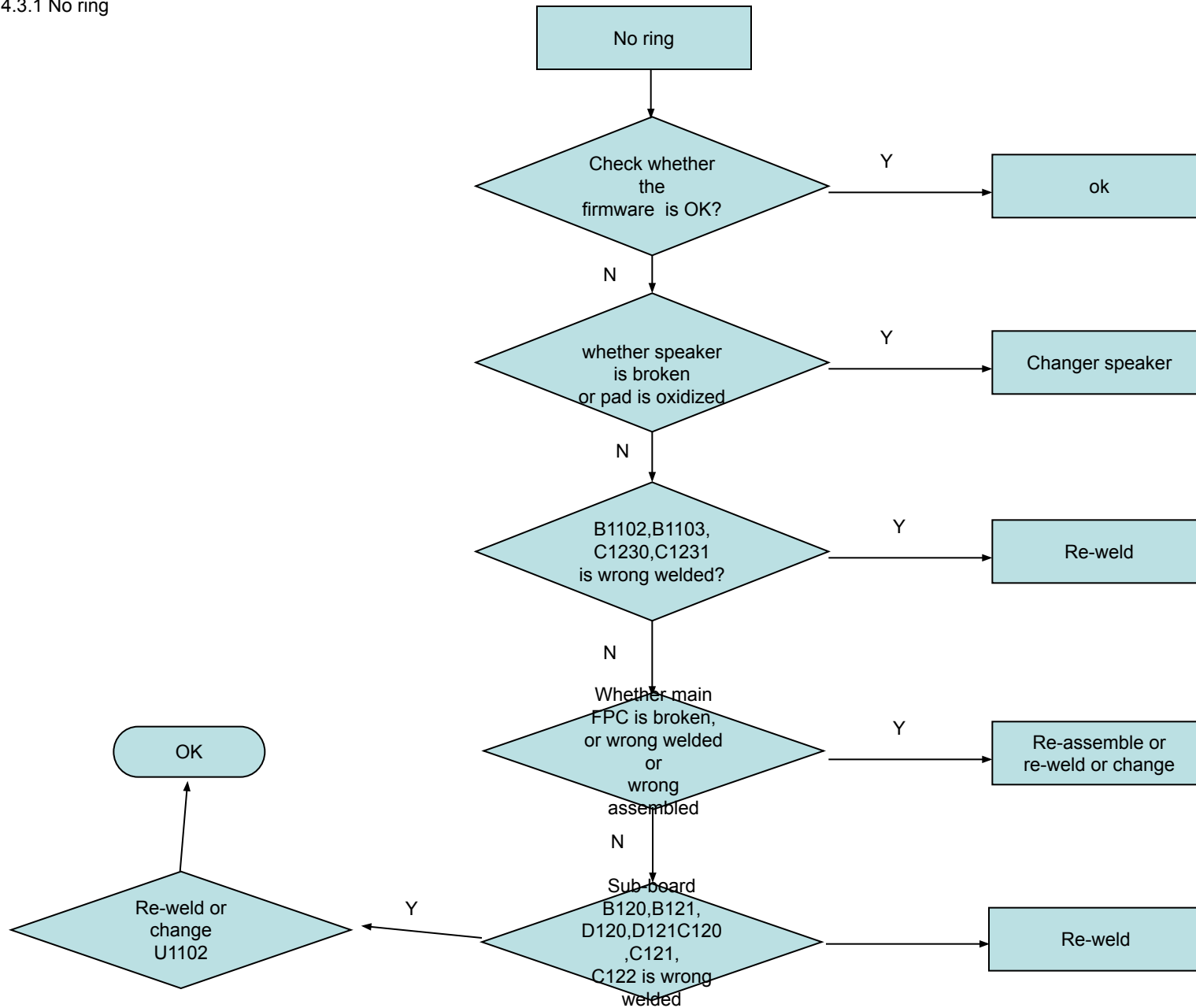

### 4.3.2 No receiving voice

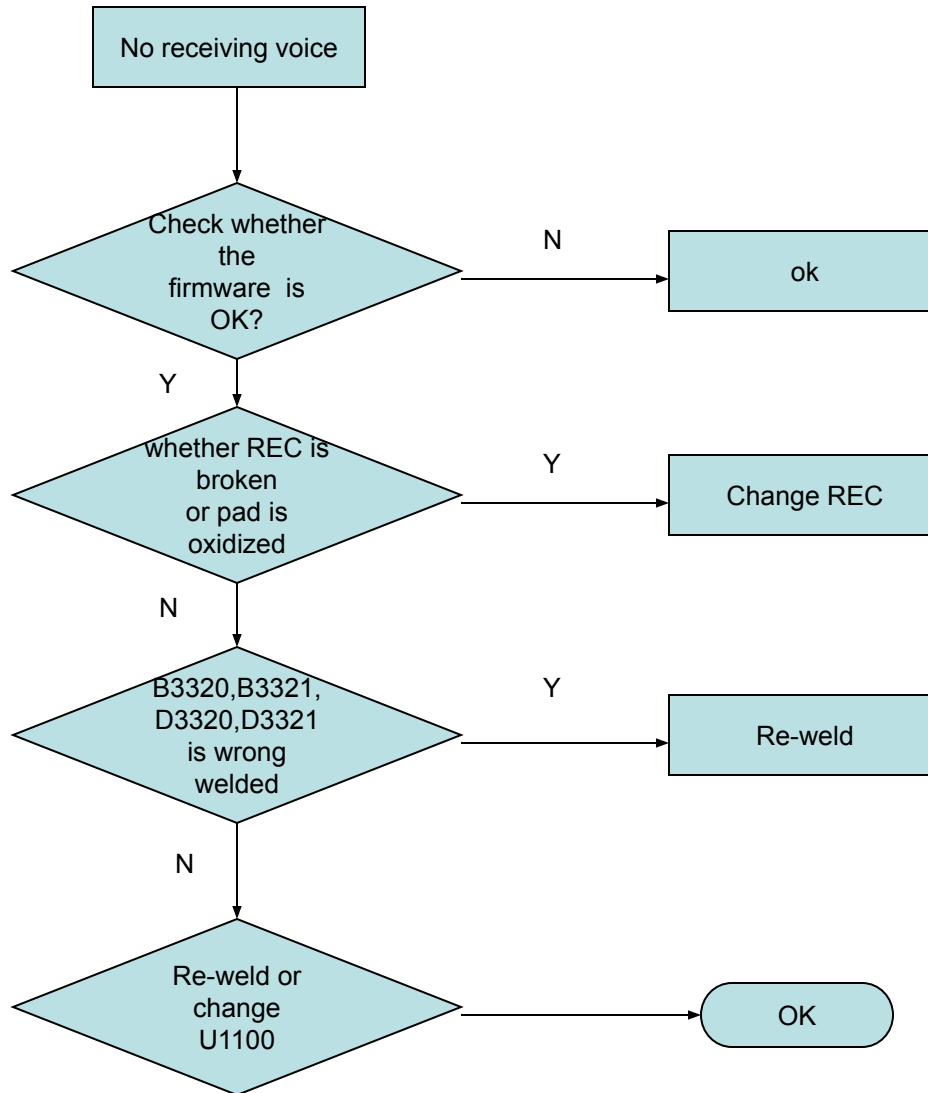



### 4.3.3 Speaker echo

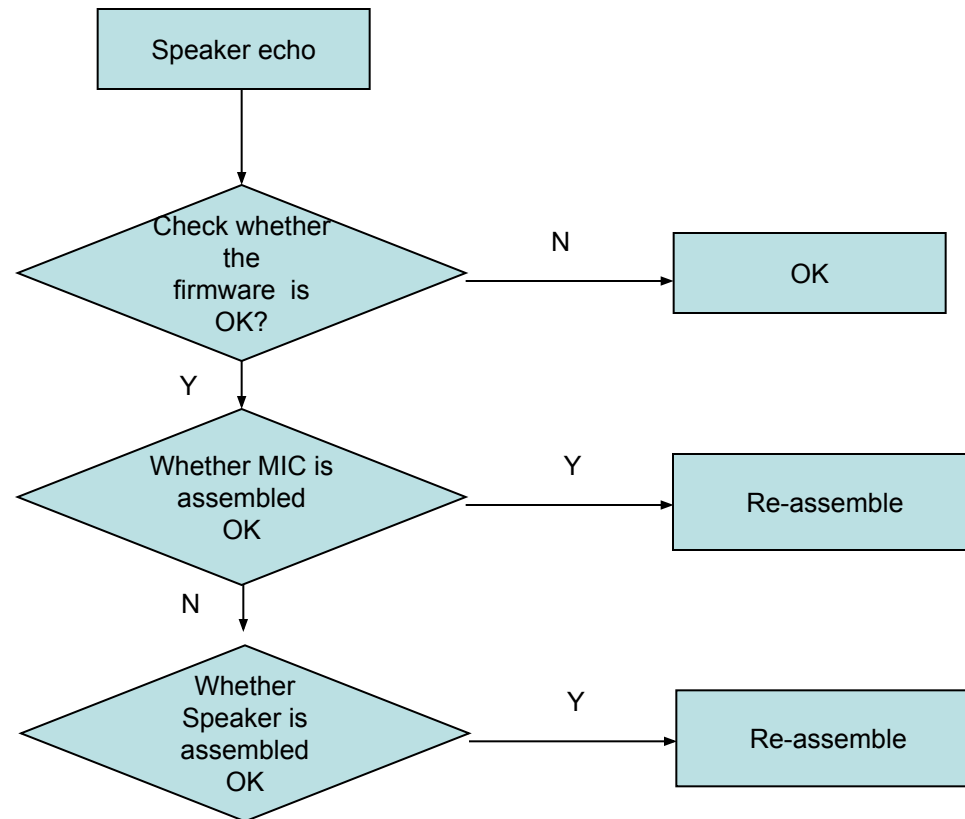

### 4.3.4 No sending voice

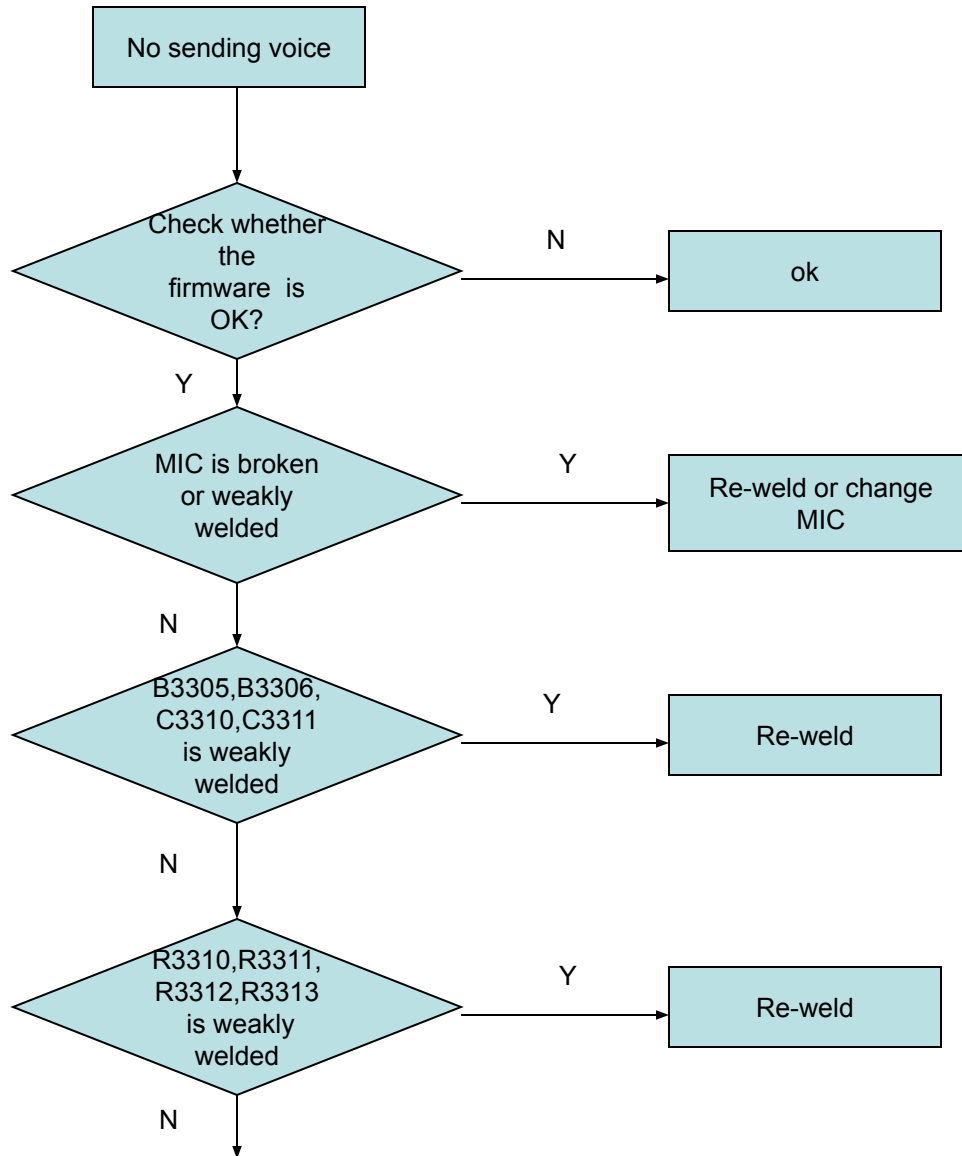

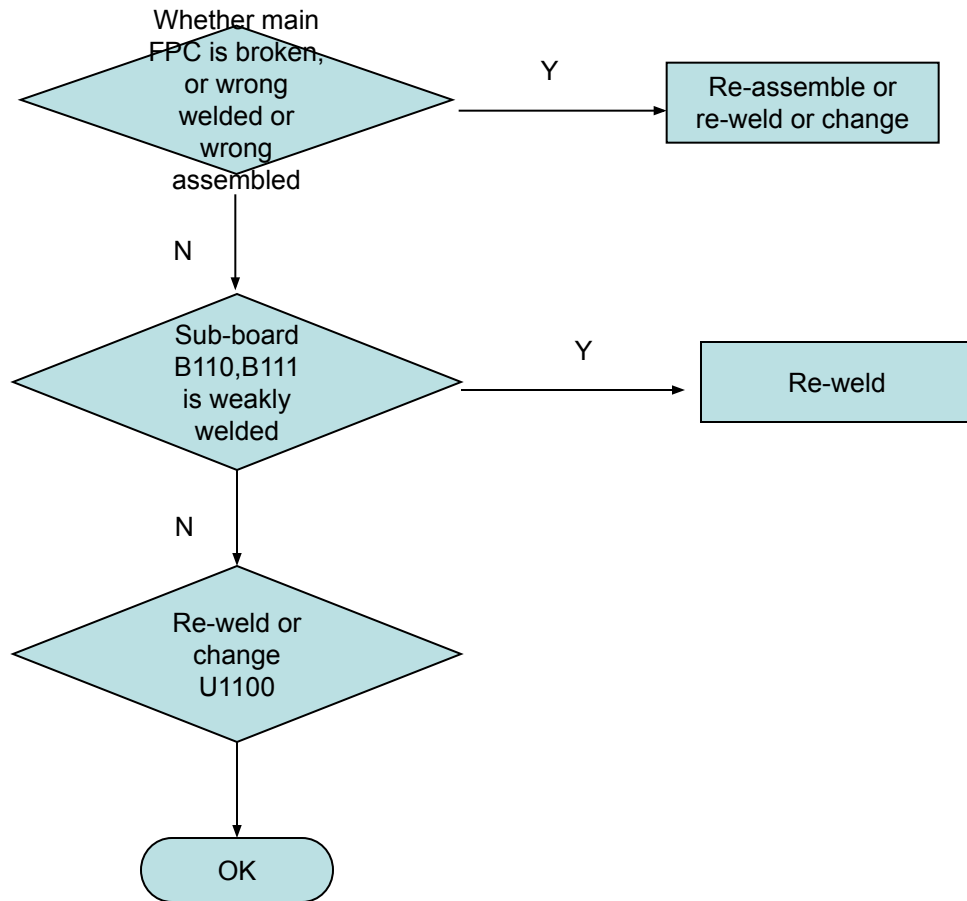

### 4.3.5 Earphone detect fail

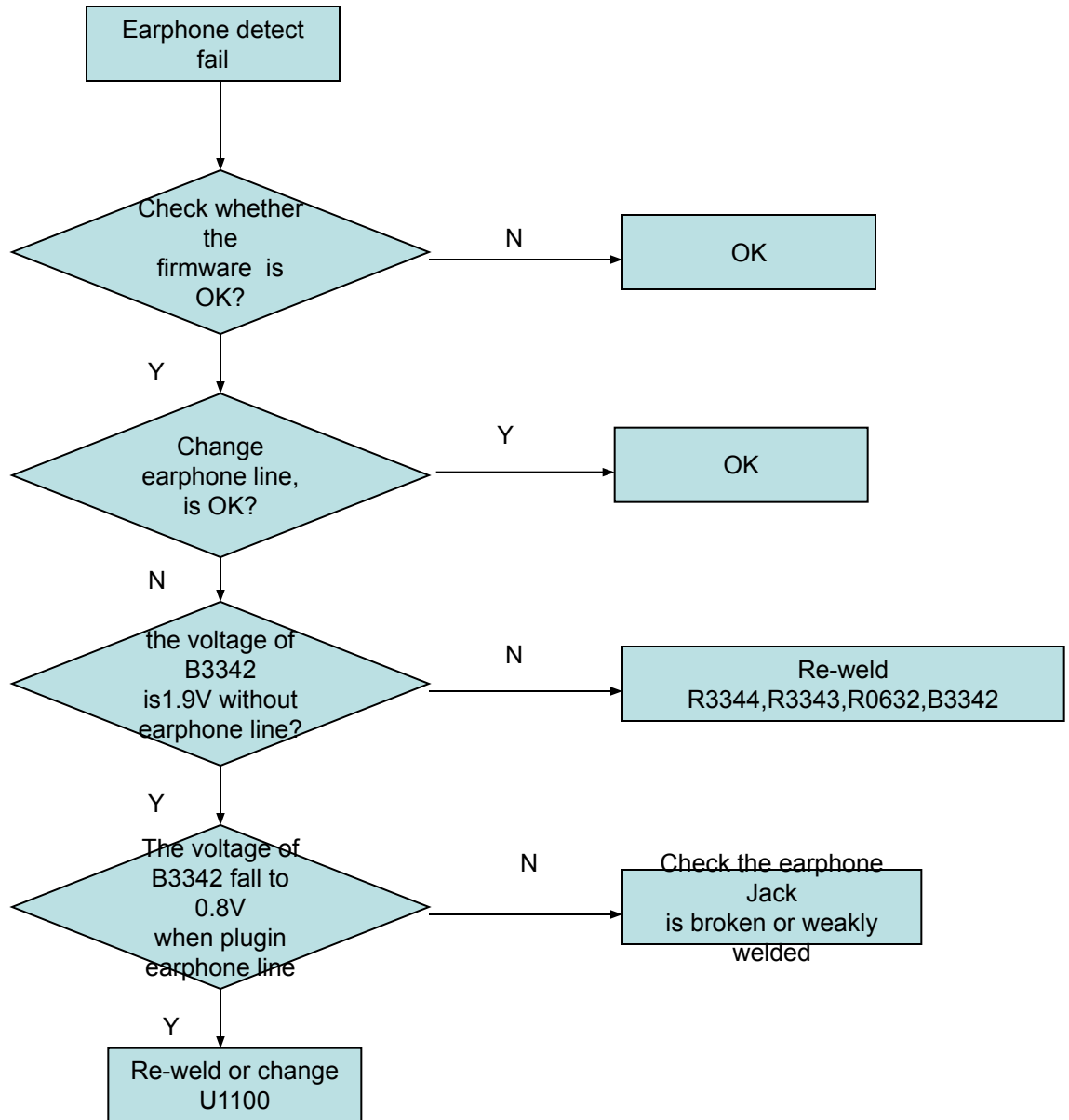

### 4.3.6 Earphone inefficacy

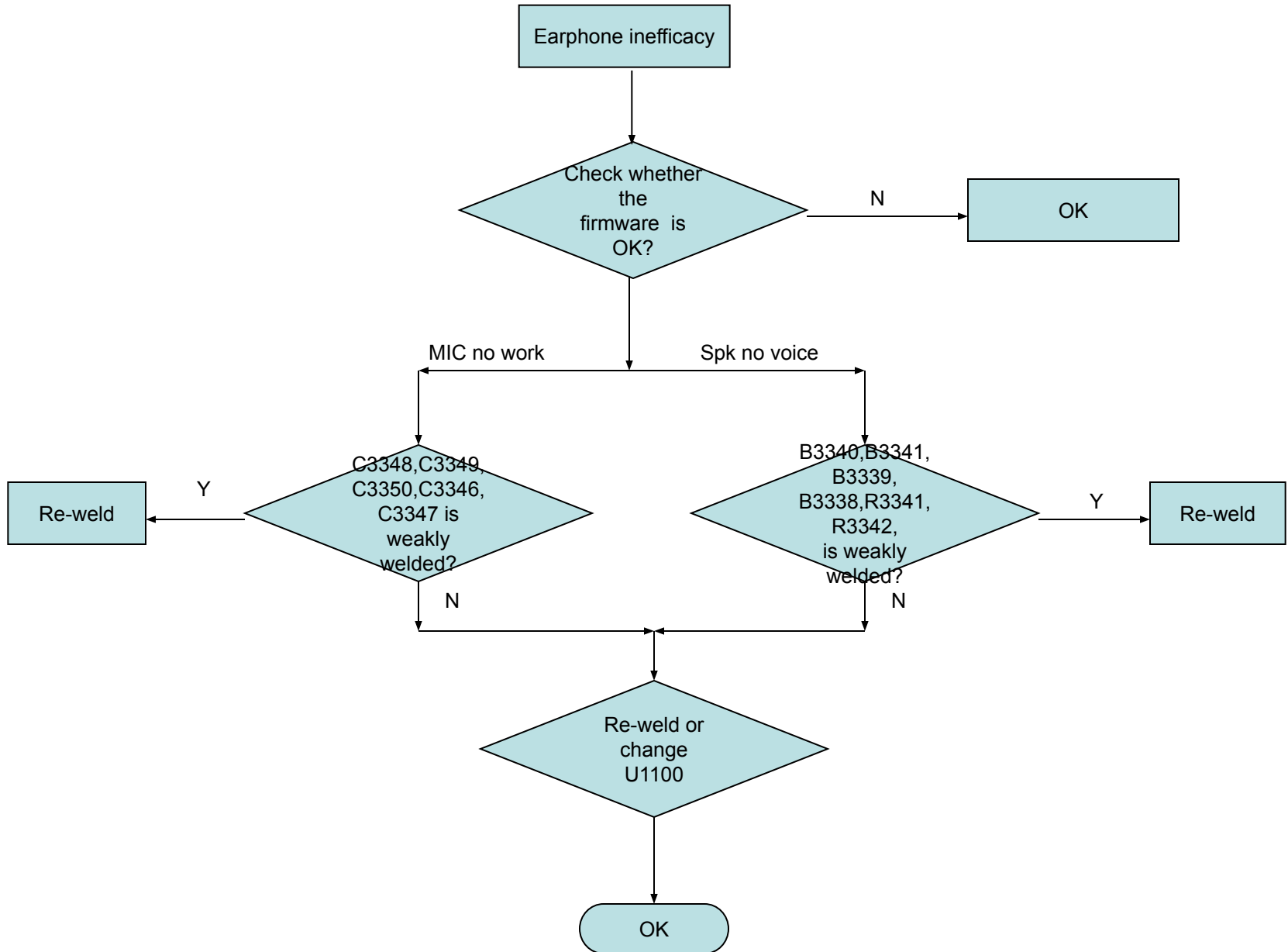

## 4.4 No vibrating

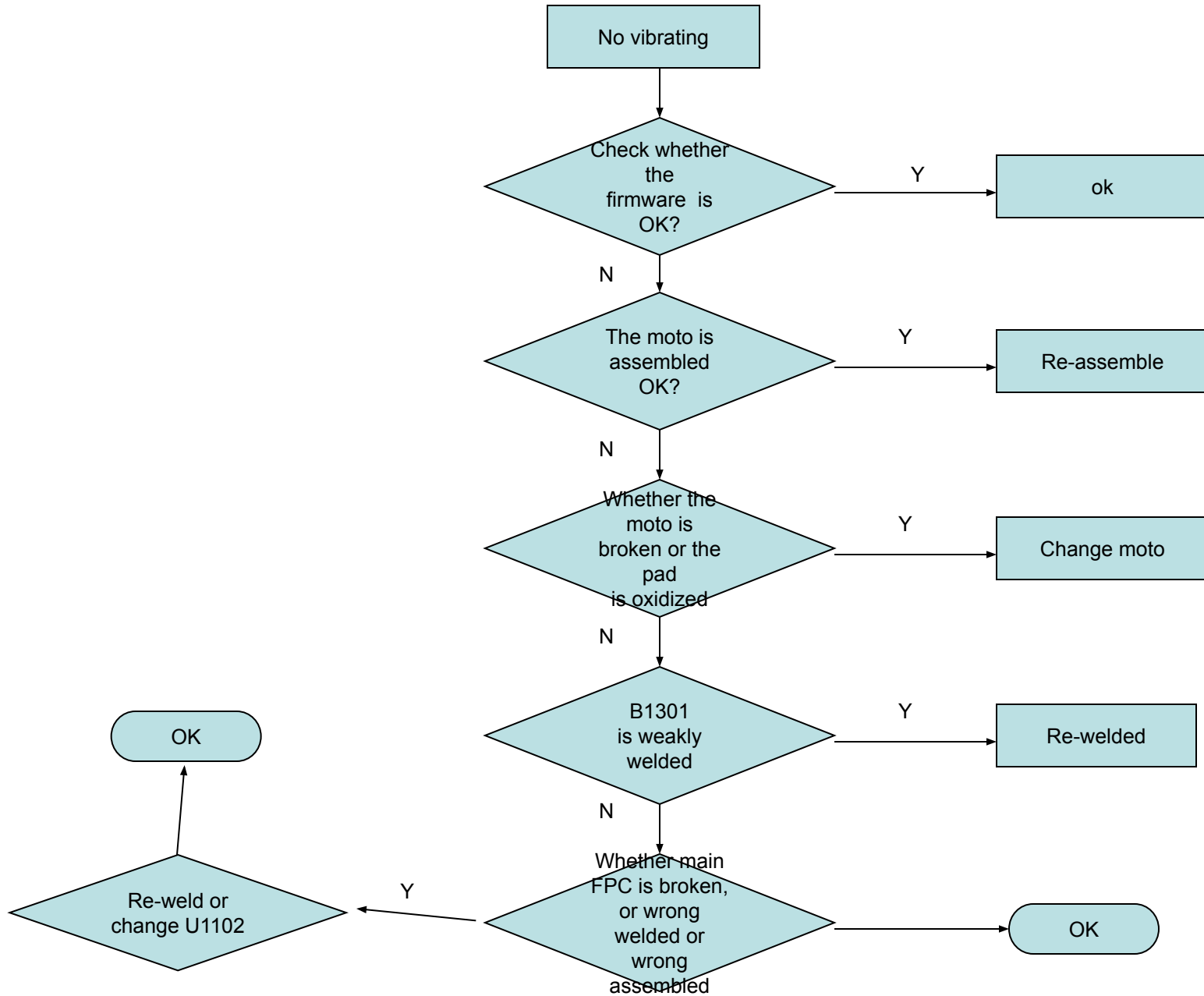

## 4.5 No charging

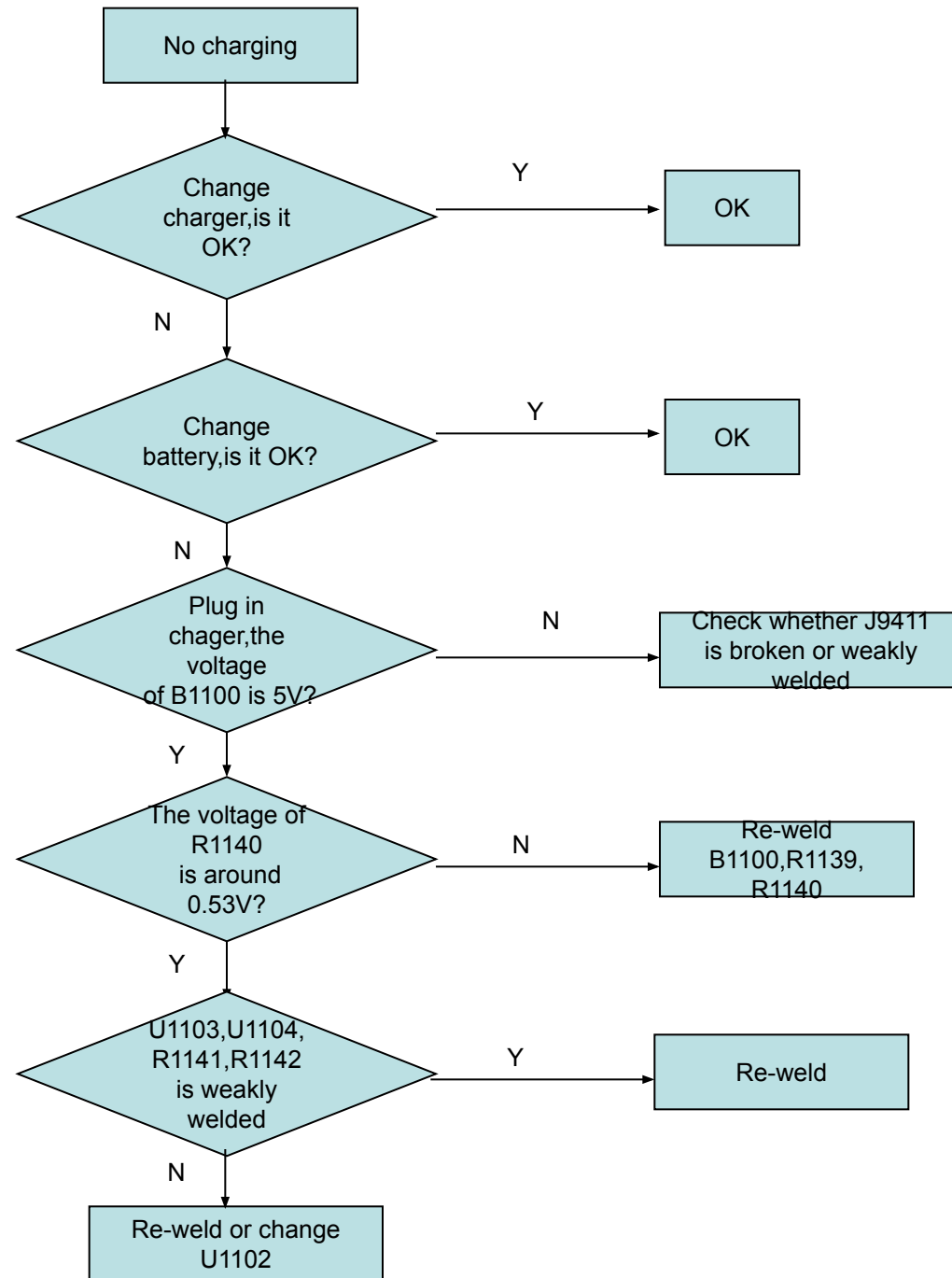



## 4.6 Camera inefficacy

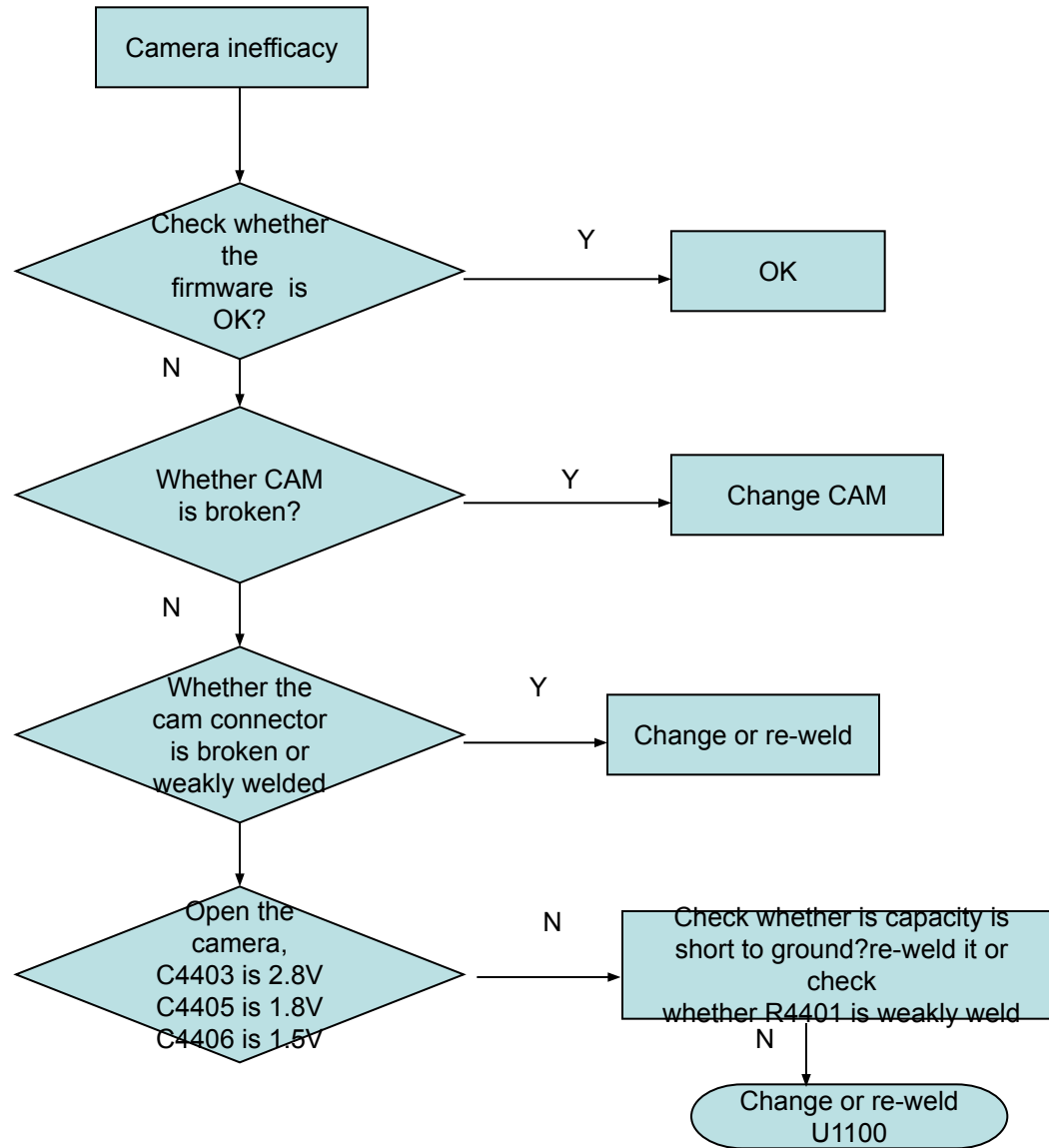

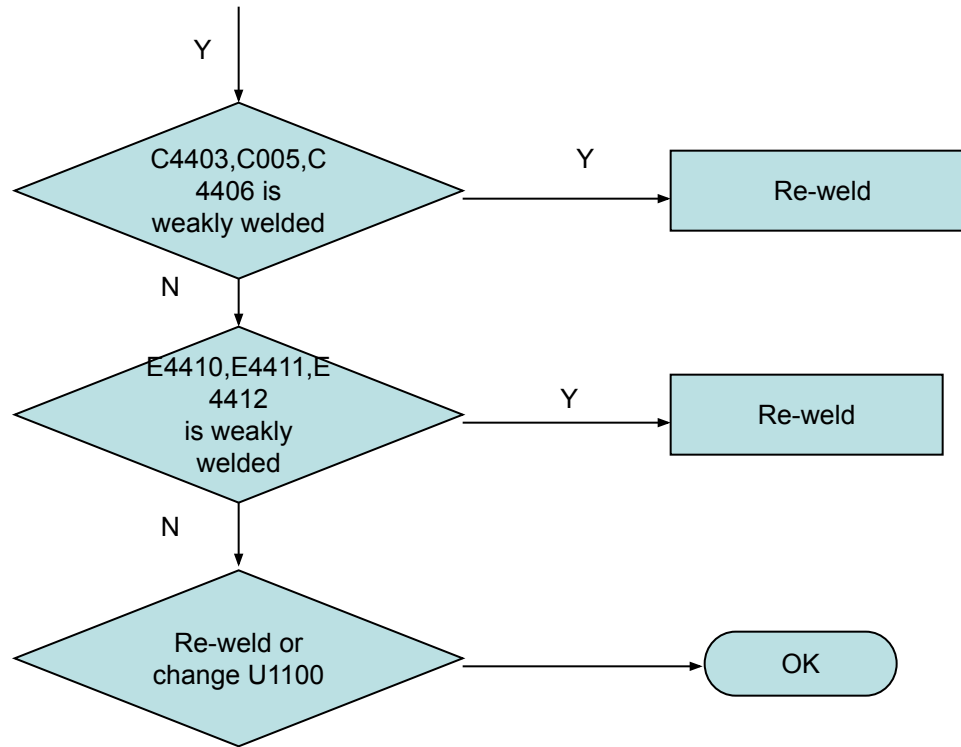

## 4.7.1 LCD display wrong

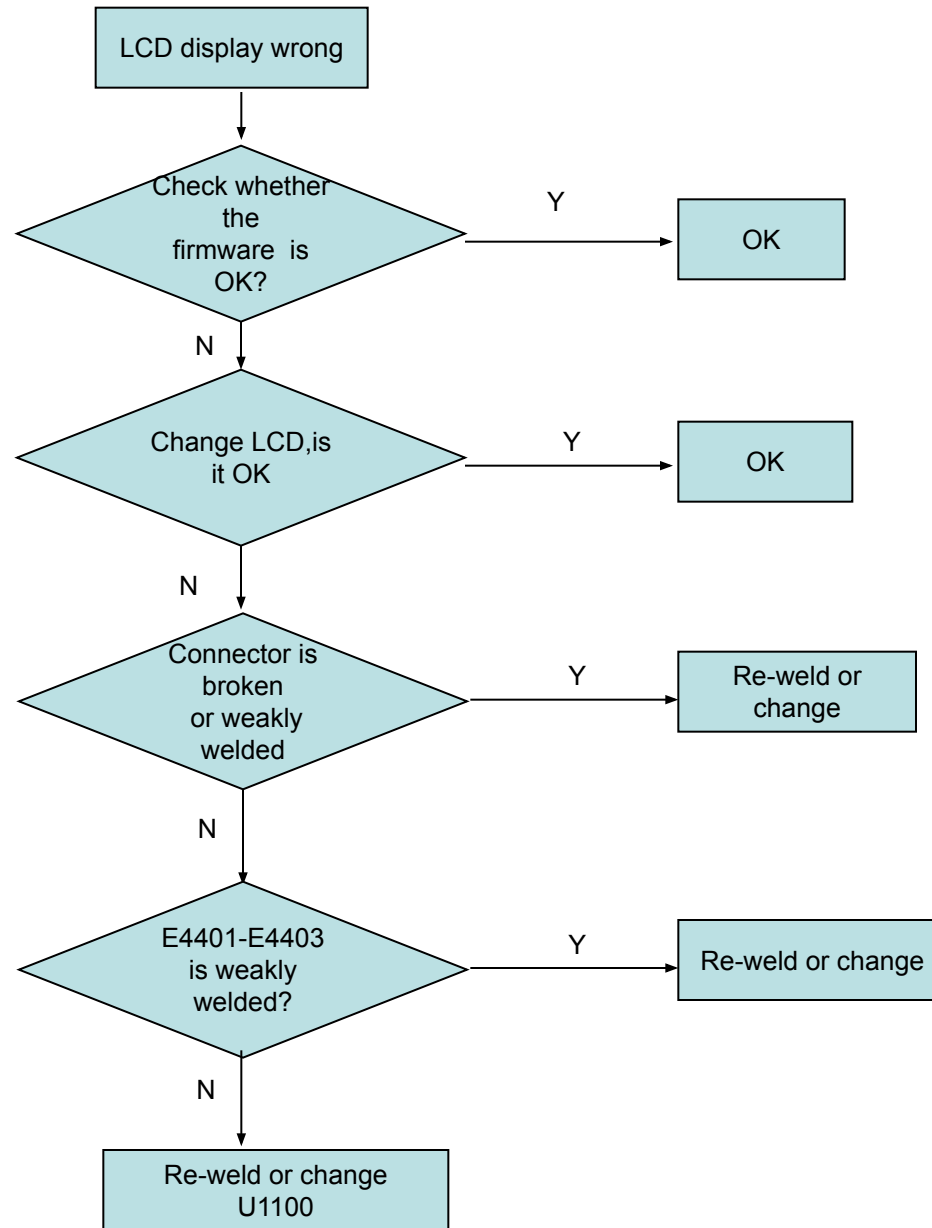

## 4.7.2 LCD backlight inefficacy

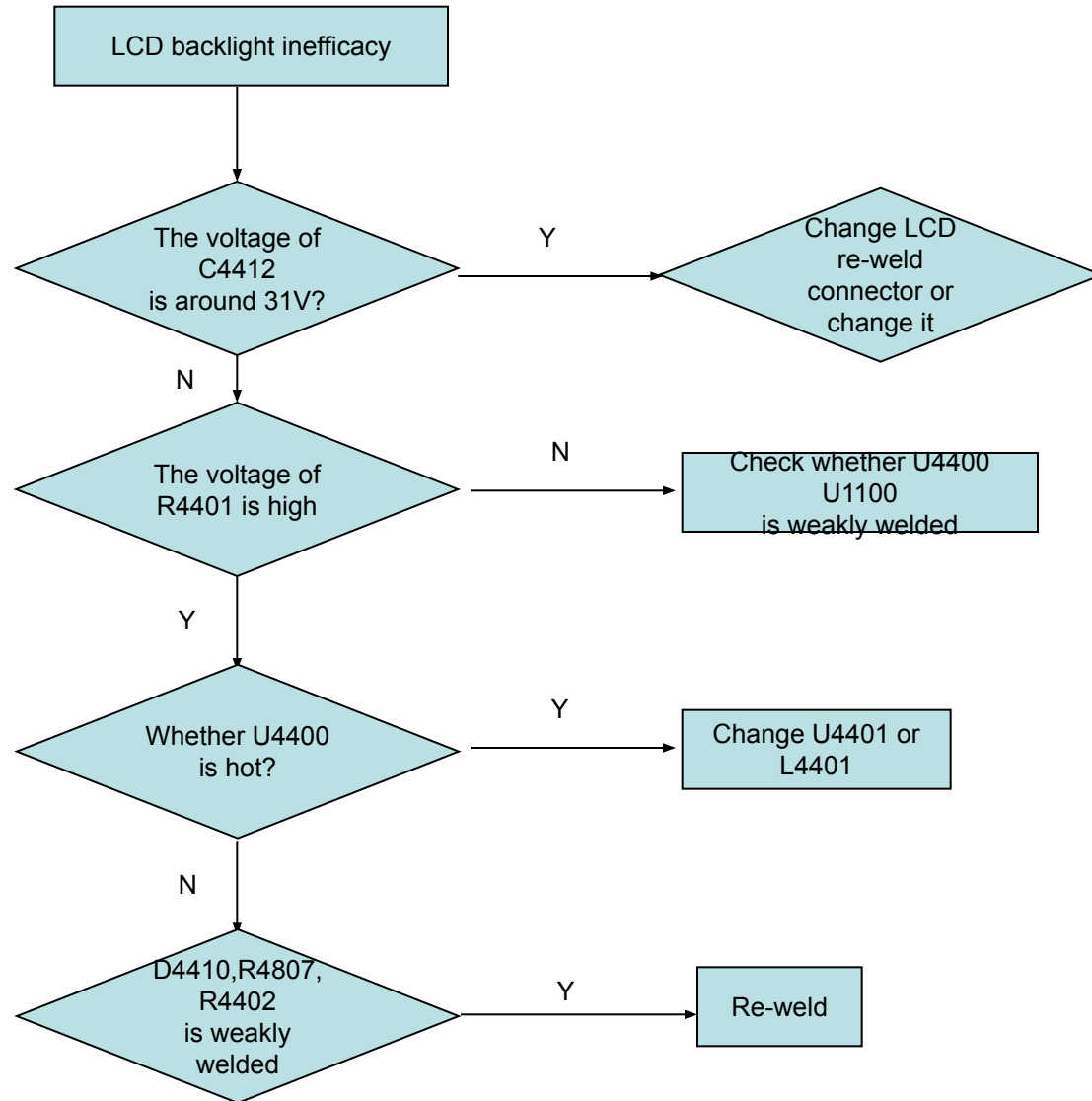

## 4.8.1 Power on fail

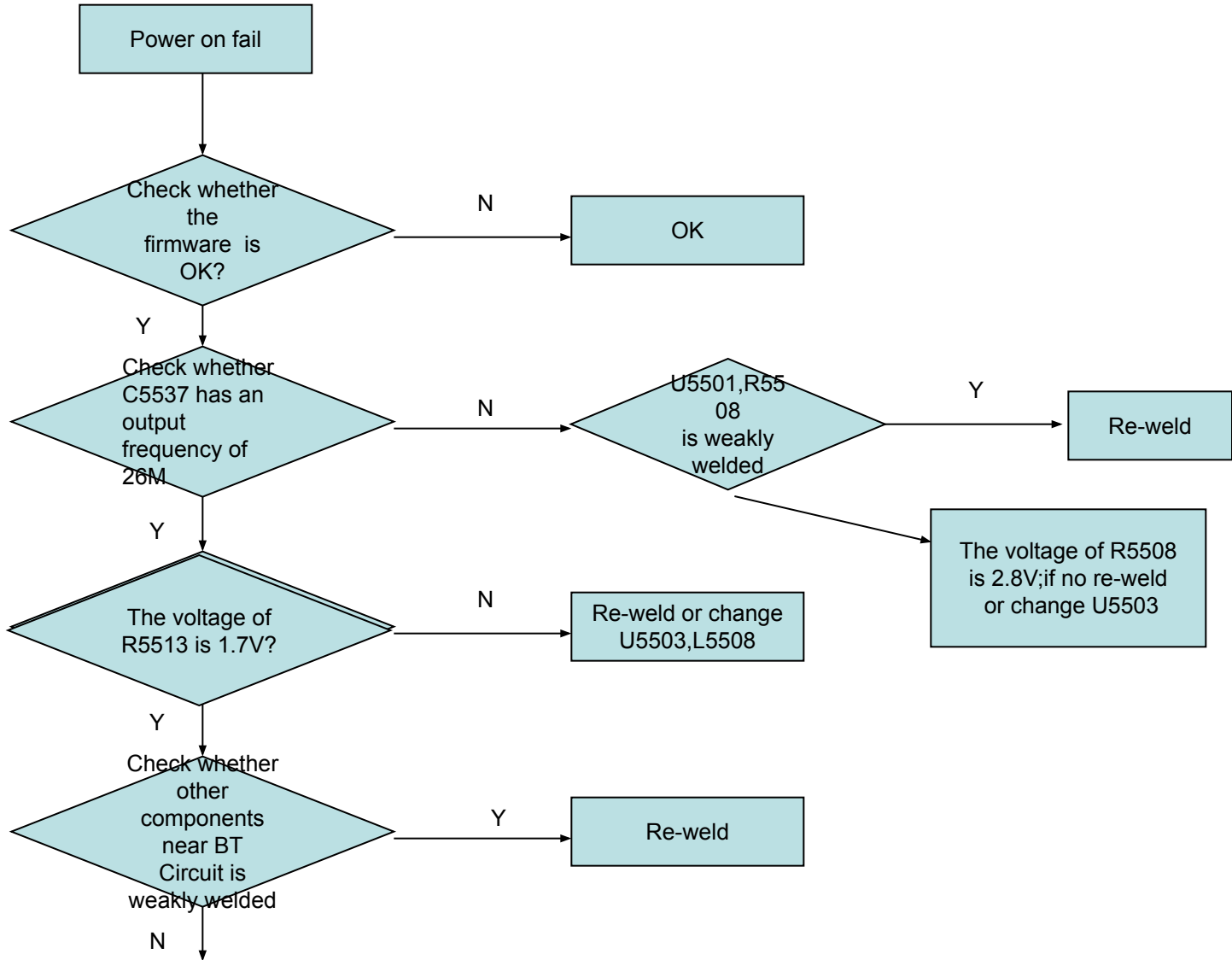

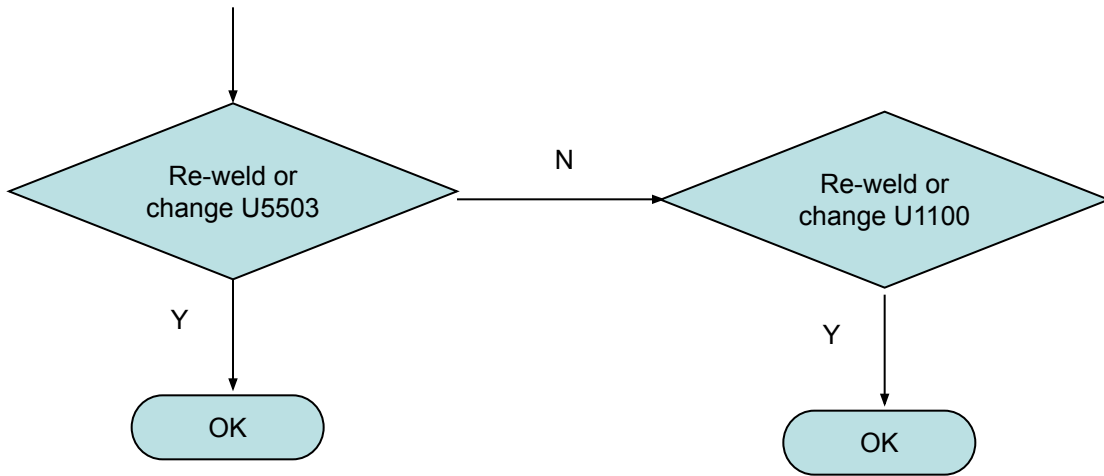

## 4.8.2 Connect fail/bad voice

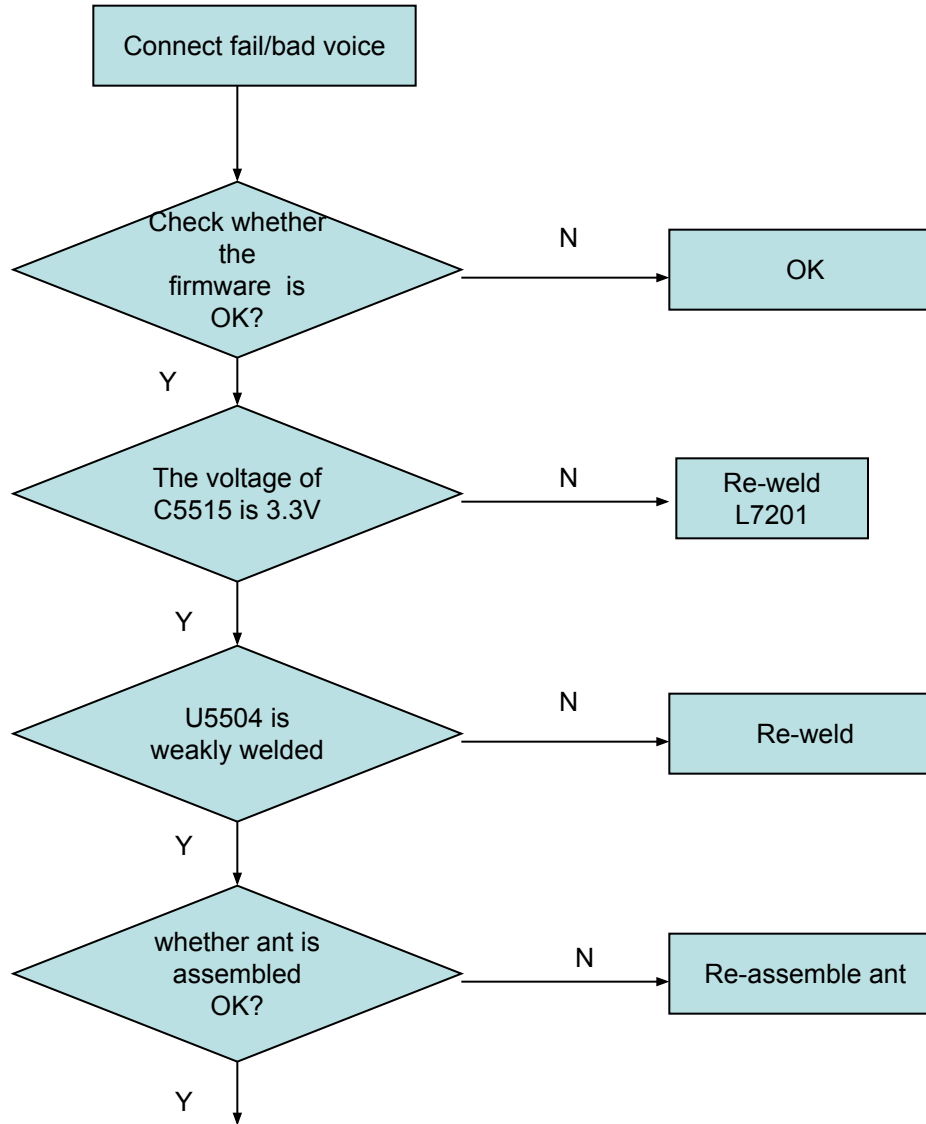



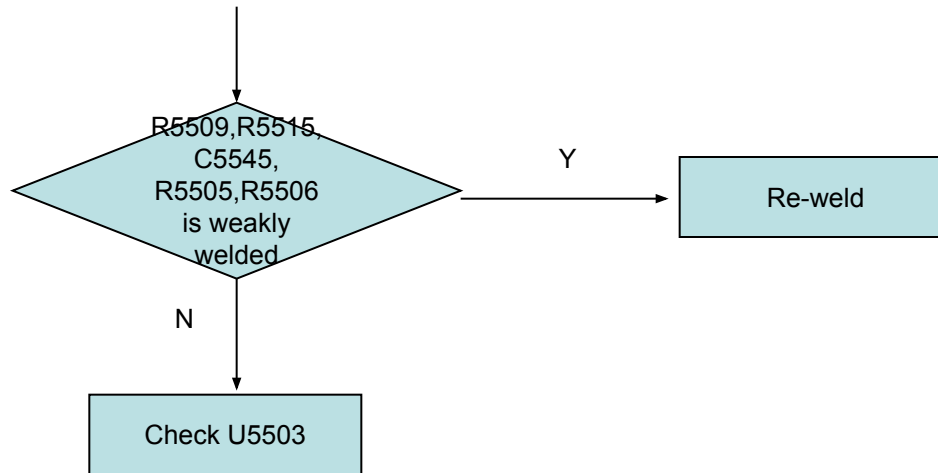

## 4.9 WIFI Inefficacy

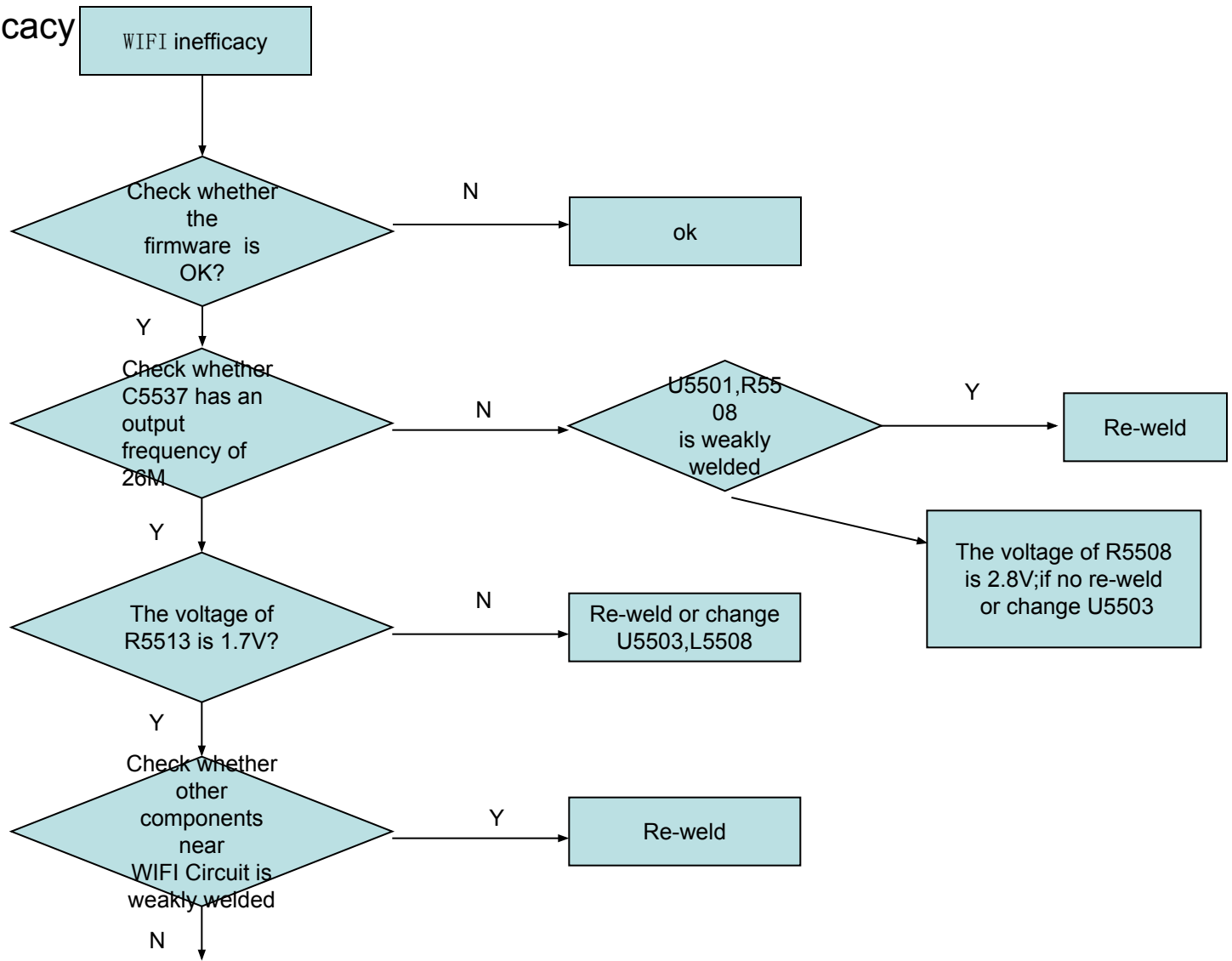

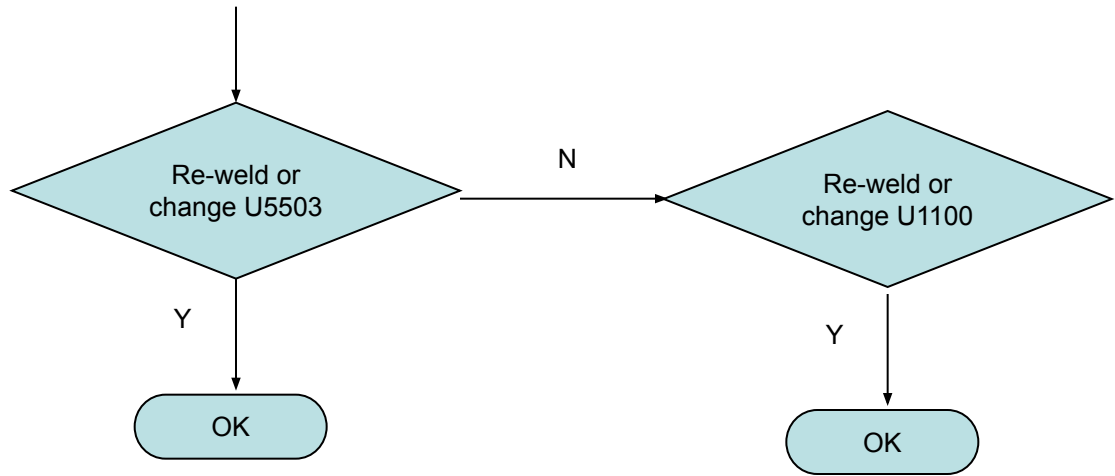

## 4.10 FM inefficacy

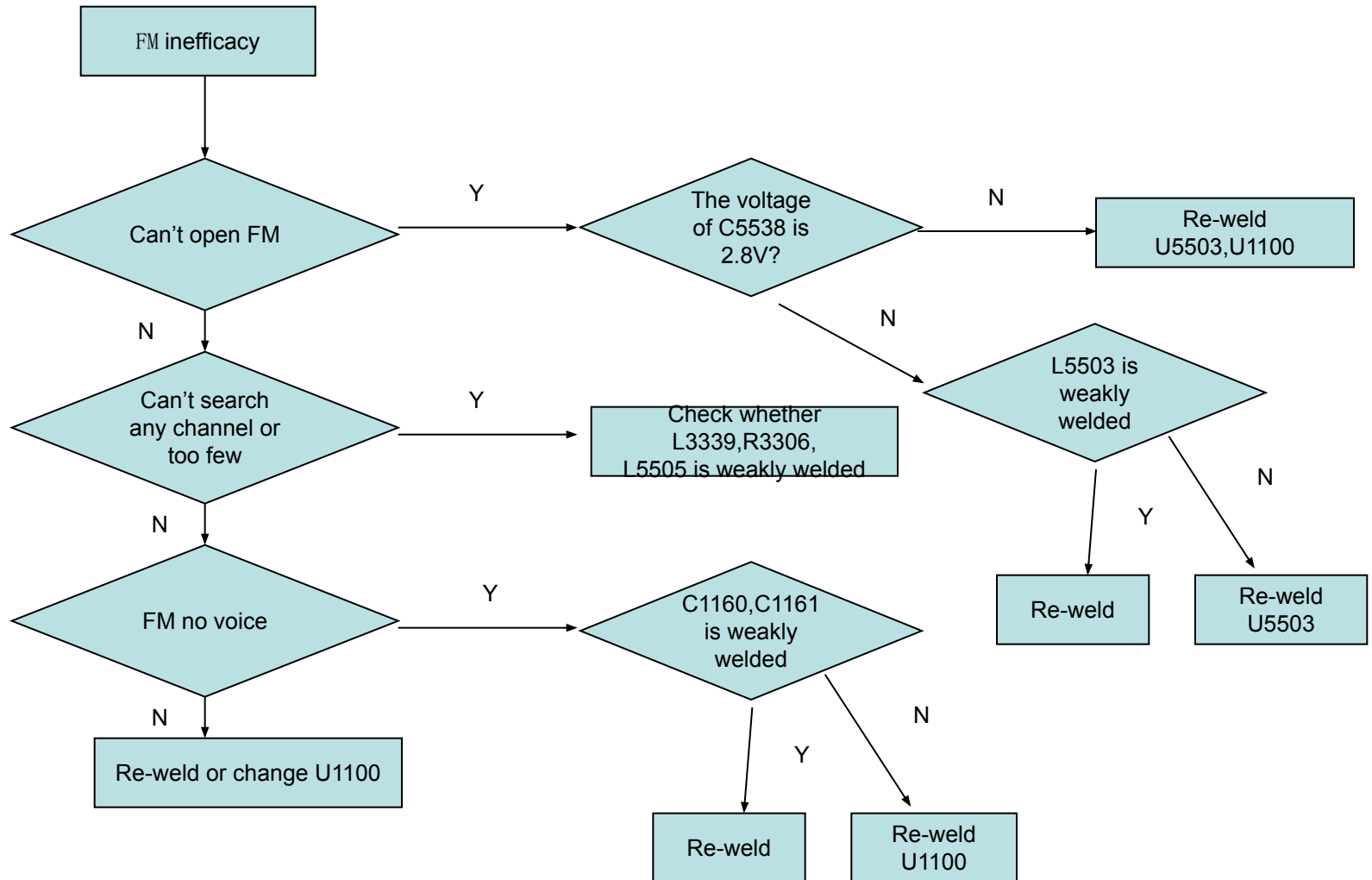

## 4.11 Key NG

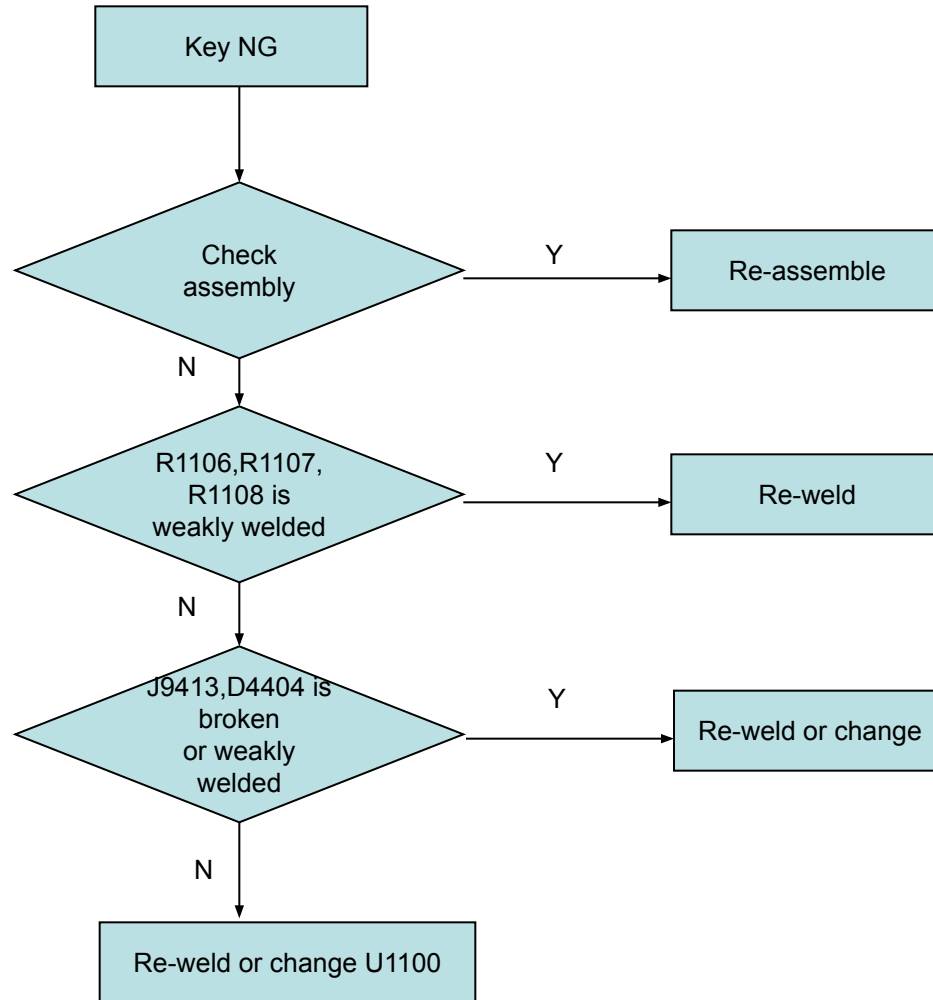

## 4.12 KEY LED NG

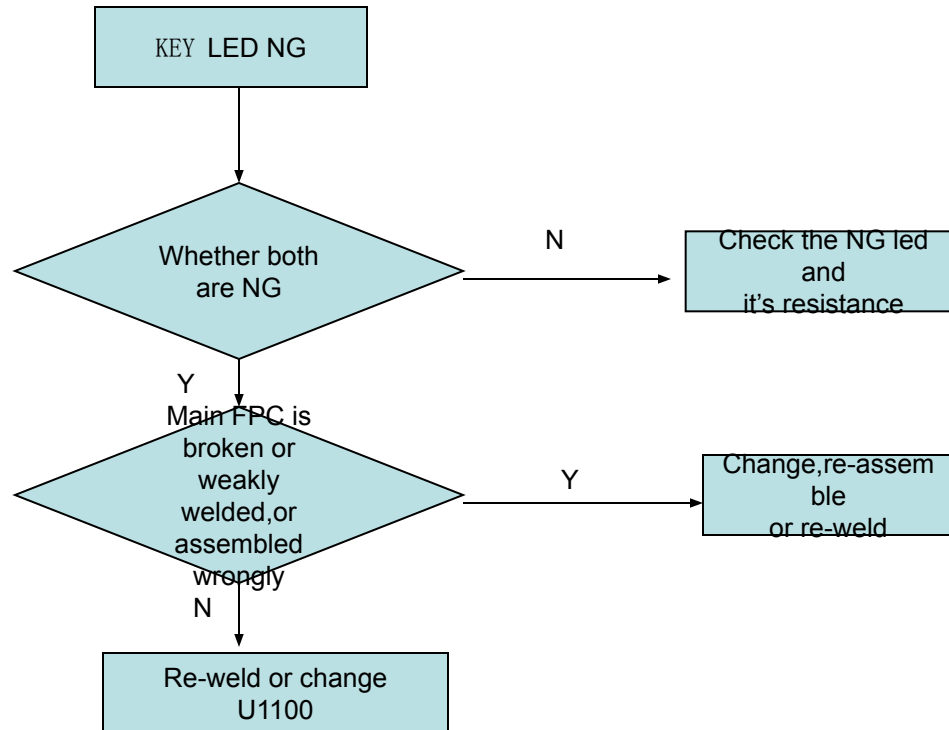

### 4.13.1 Proximity sensor NG

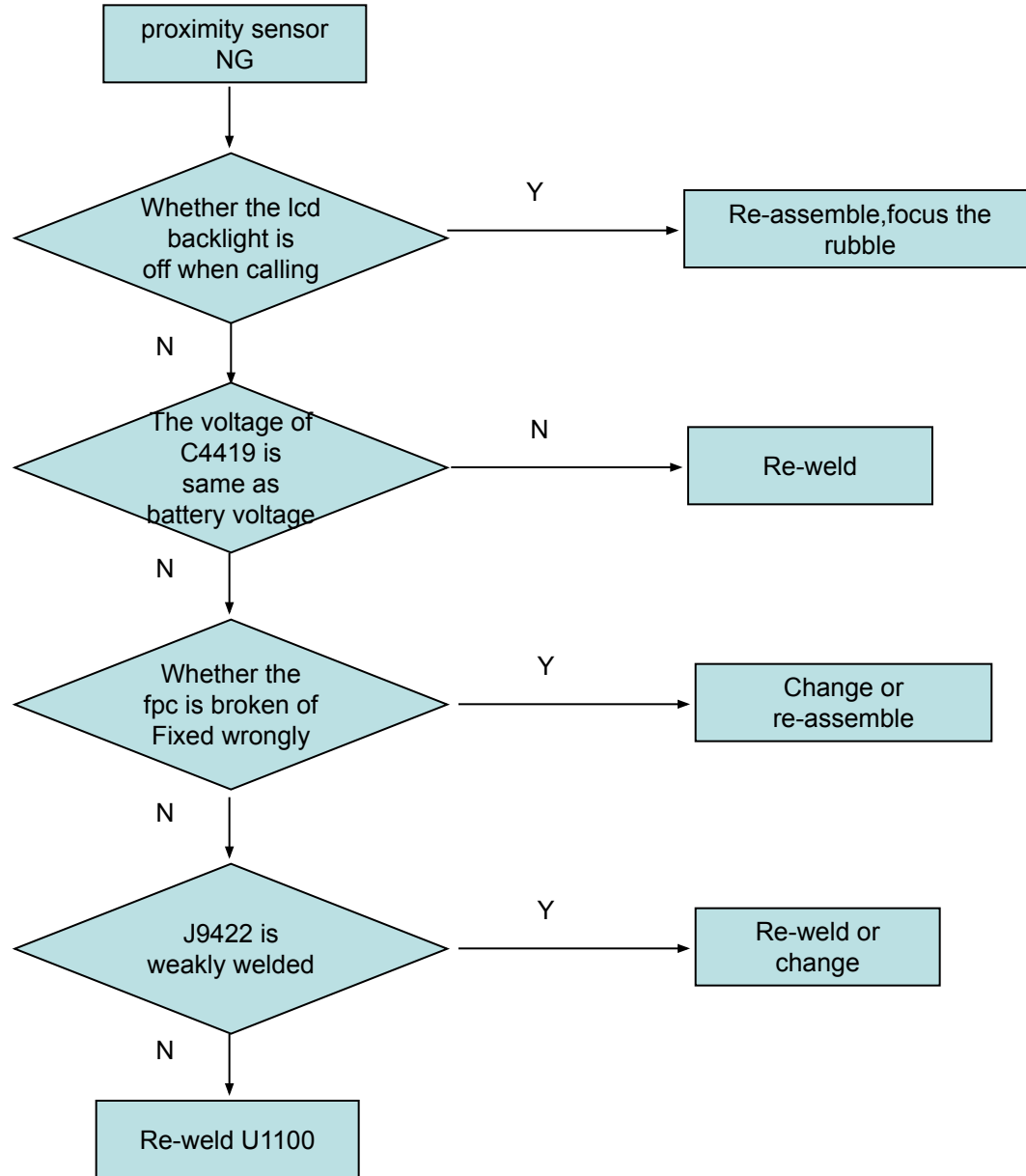

## 4.13.2 Gsensor NG

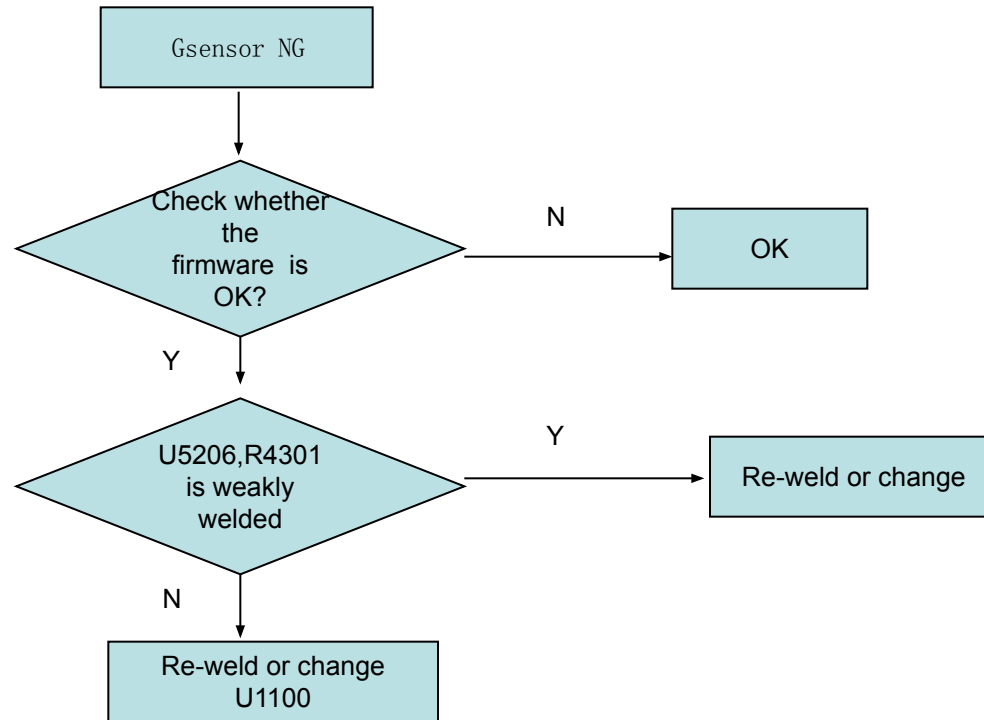



## 4.14 SIM card inefficacy

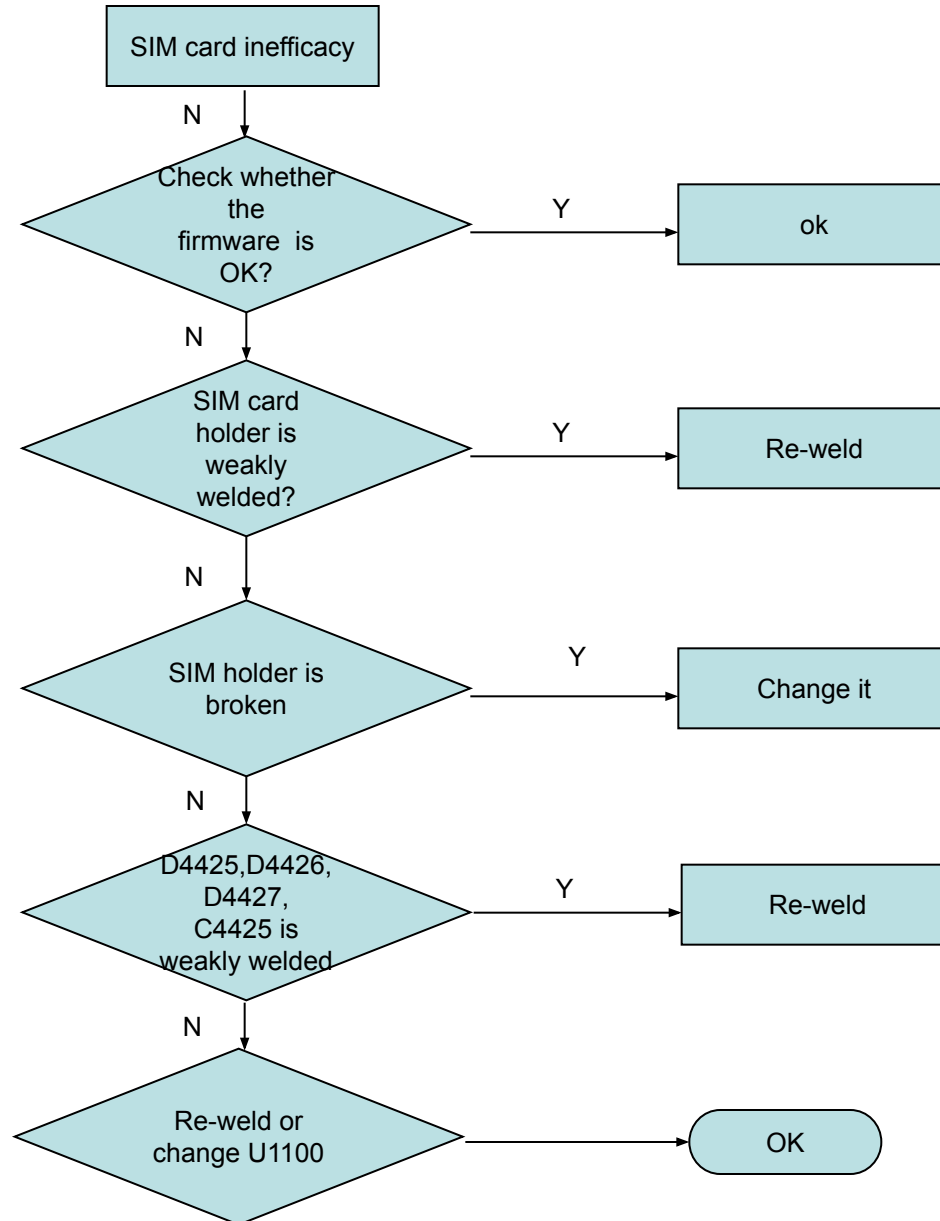

### 4.15 TF card inefficacy

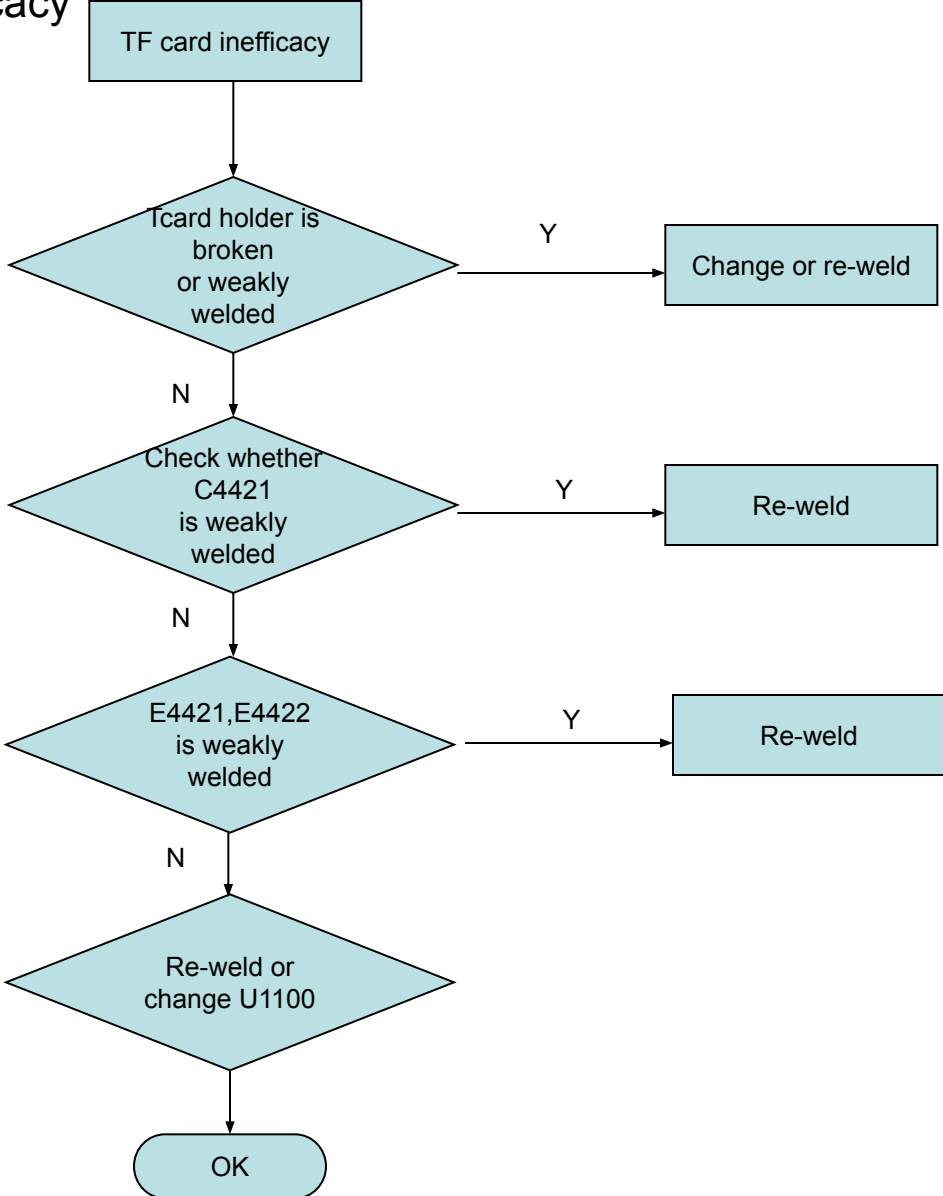

## 4.16 GPS inefficacy

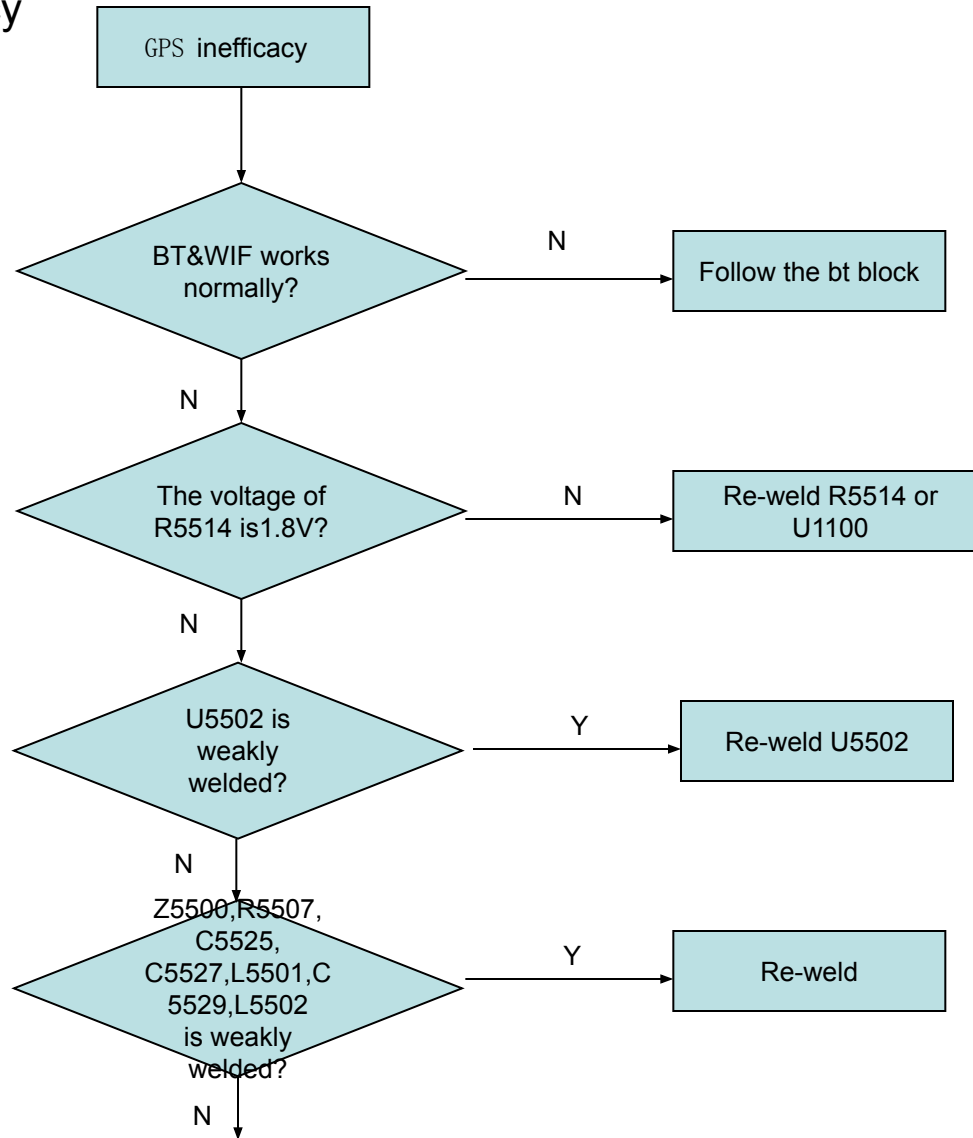

# 4.16 GPS inefficacy

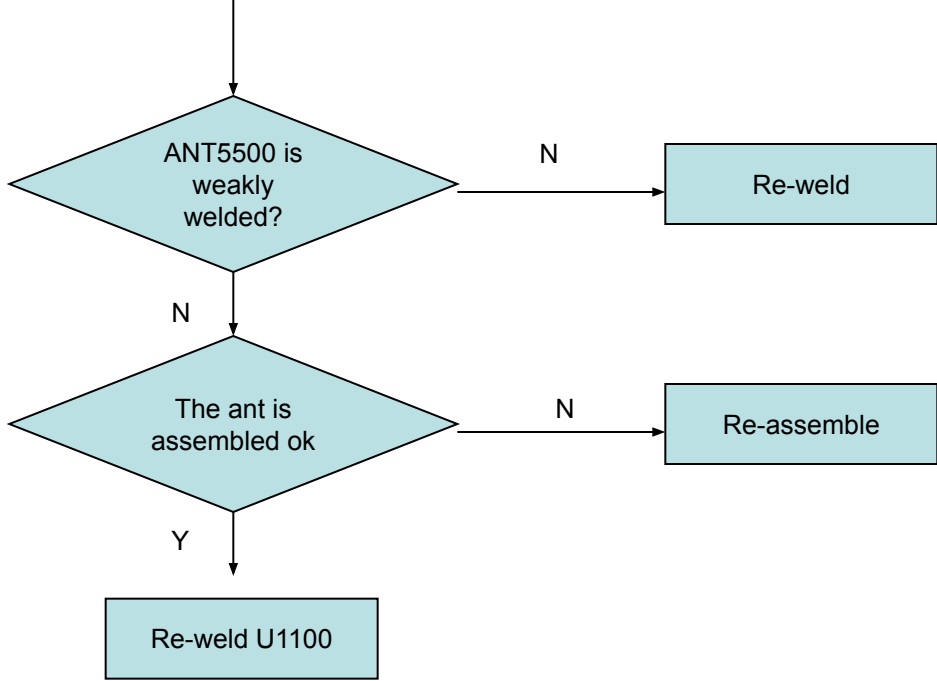

## 4.17 TP inefficacy

