

Input and output signals

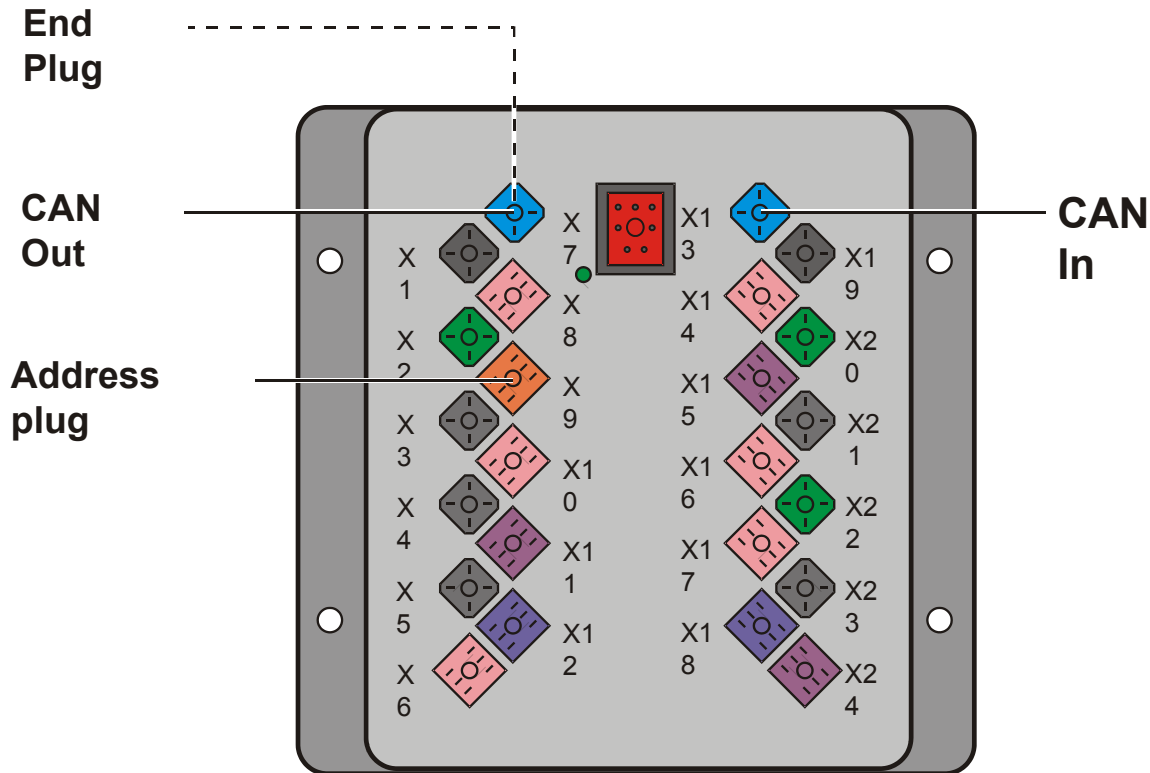

Input and output signals

Connections I/O-Module



Digital In: X15, X11, X24

Digital Out: X2, X20, X22

Analogue In: X6, X8, X10, X14, X16, X17

PWM Out: X1, X3, X4, X5, X19, X21,

Encoder (Pulse sensor in): X12, X18

Input and output signals

Digital input signal on I/O modules (DIN)

- Digital inputs
 - X11
 - X15
 - X24

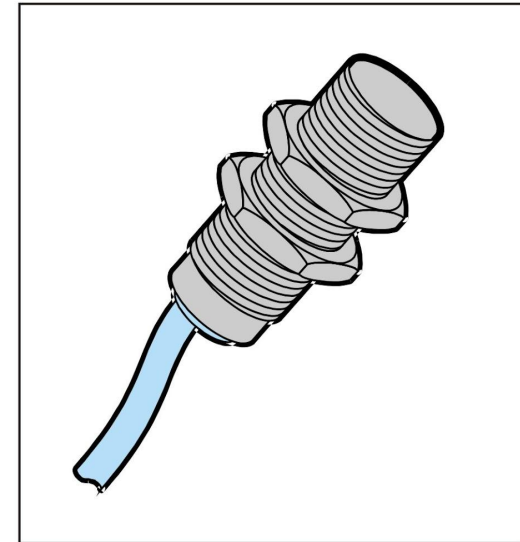
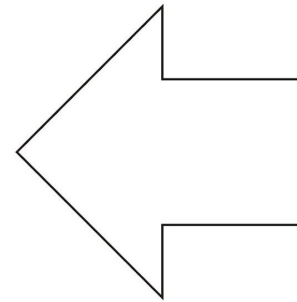
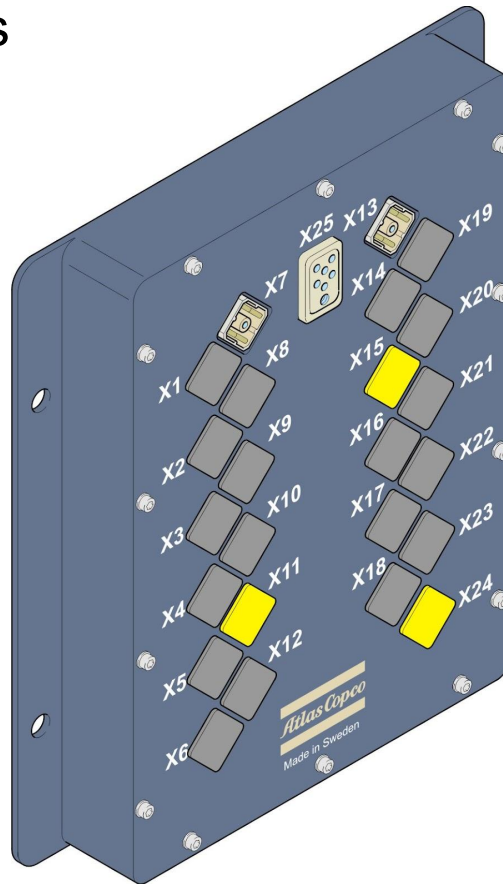

Input and output signals

Digital output signal on I/O modules (DOUT)

- Digital outputs
 - X11
 - X15
 - X24

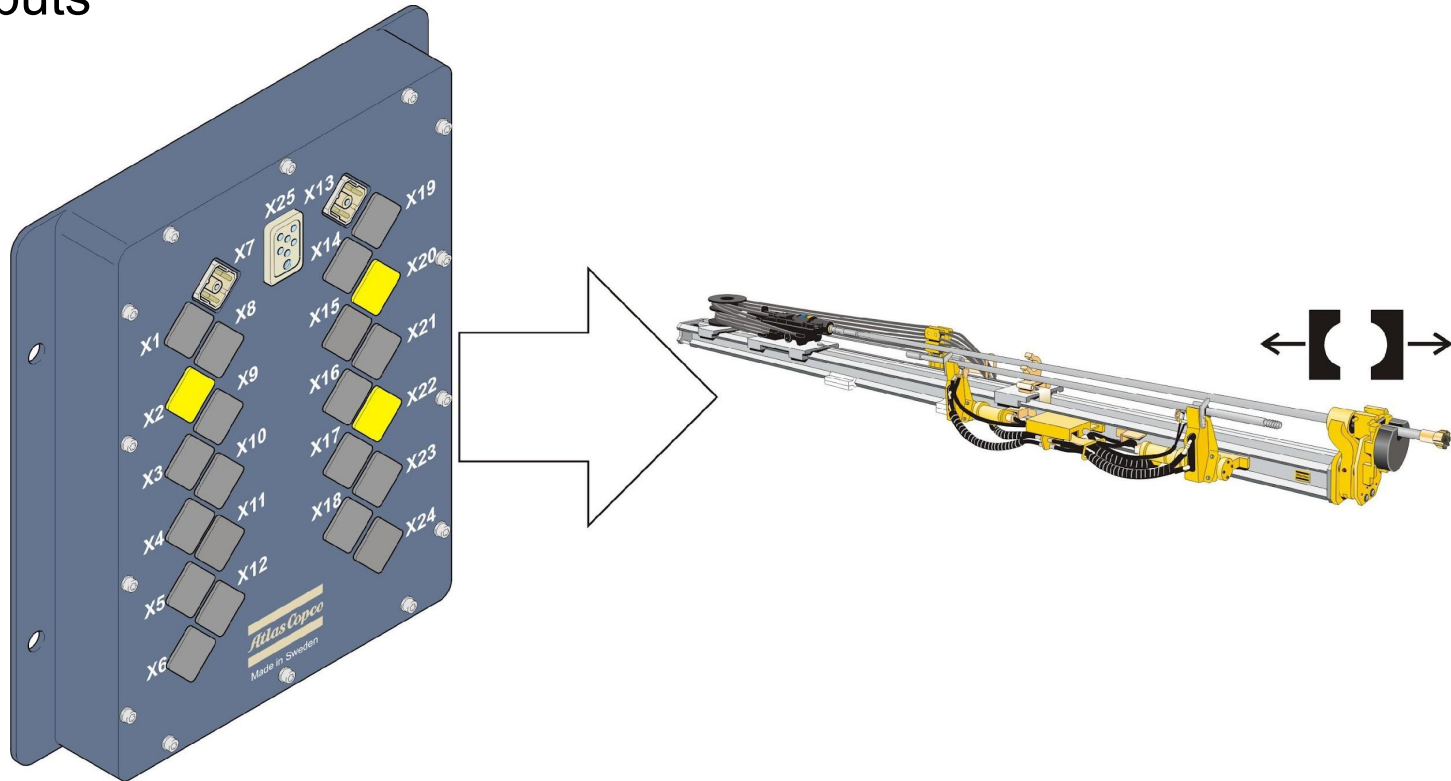

Input and output signals

Analogue input signal on I/O modules (AIN)

- Analogue inputs
 - X6
 - X8
 - X10
 - X14
 - X16
 - X17

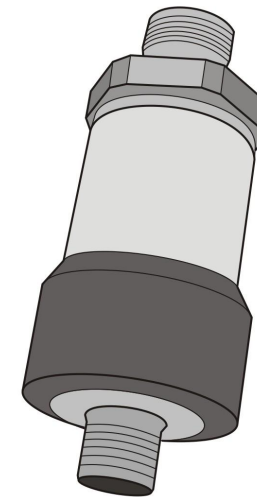
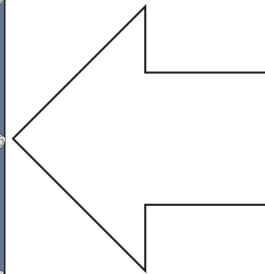
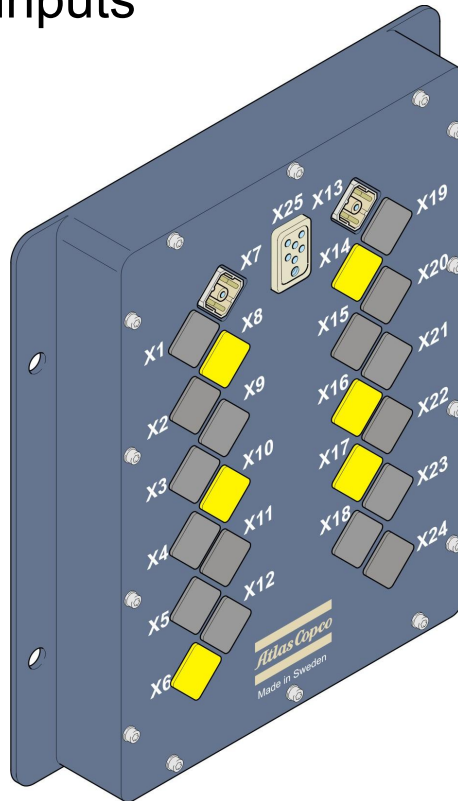

Input and output signals

PWM output signal on I/O modules (PWM)

- PWM outputs

- X1
- X3
- X4
- X5
- X19
- X21
- X23

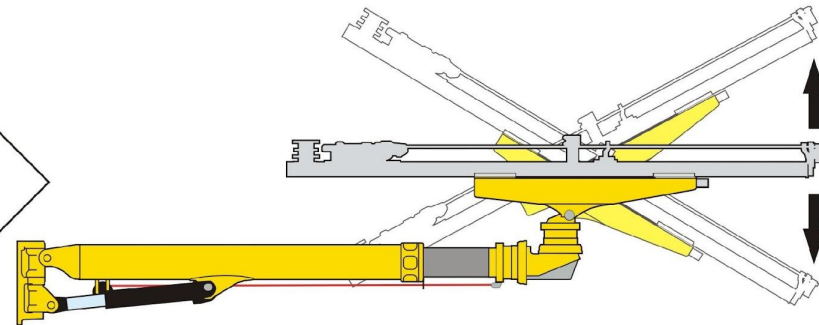
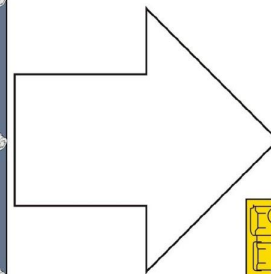
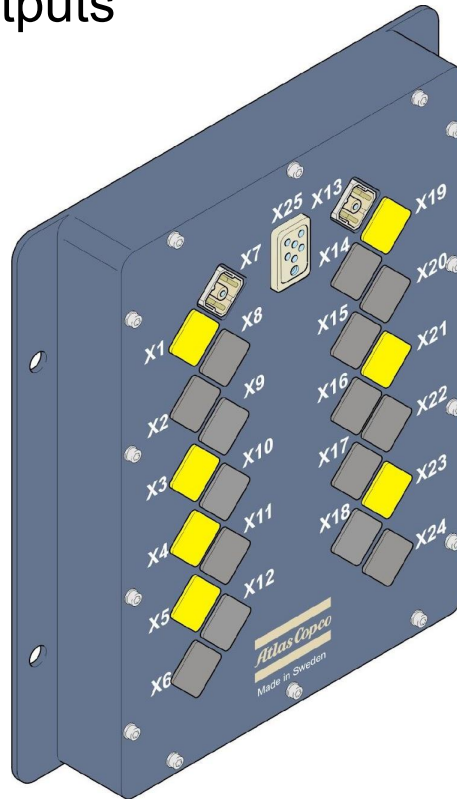

Input and output signals

Encoder input signal on I/O modules (DIG-ENC)

- Encoder inputs
 - X12
 - X18

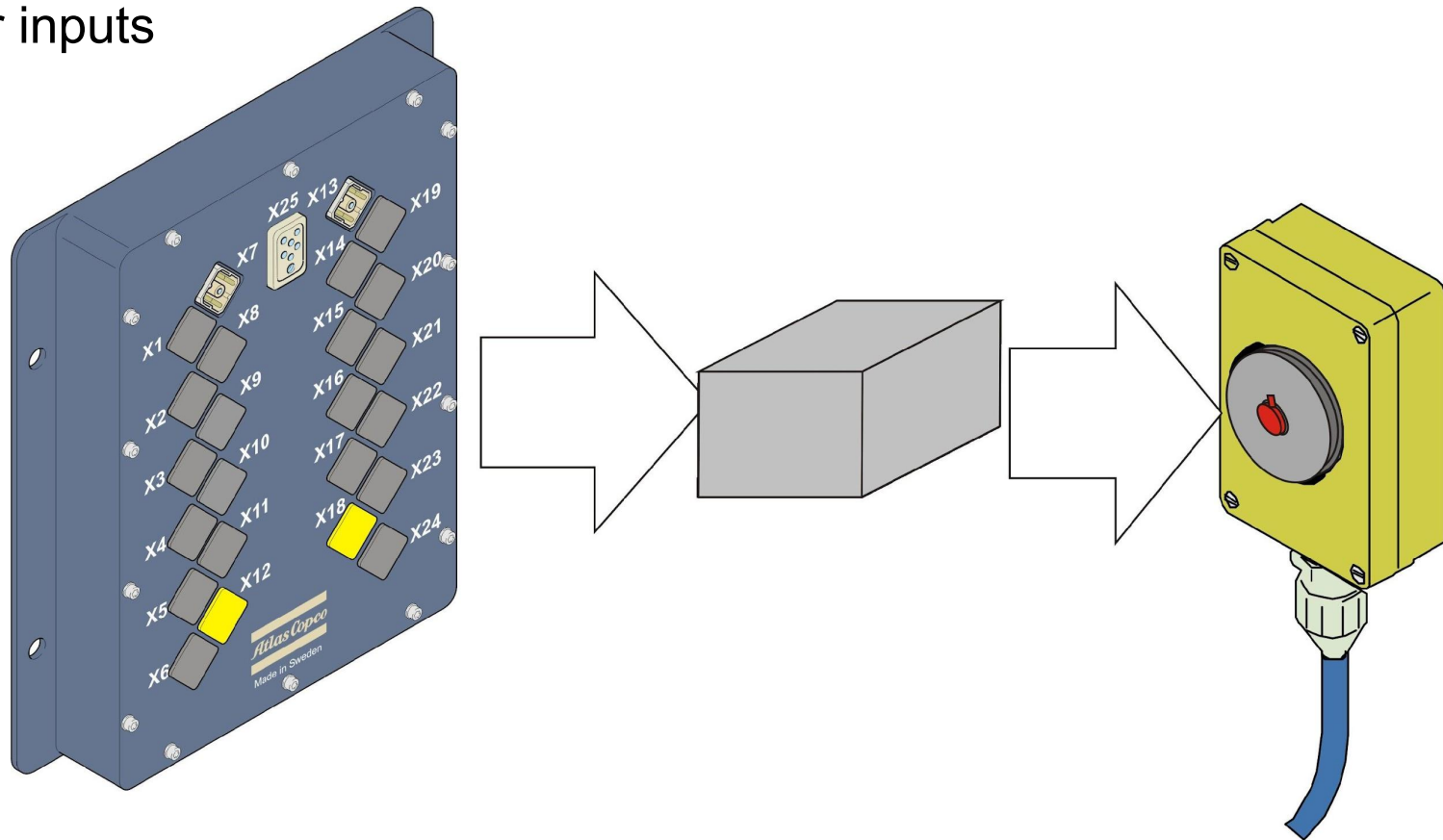

Input and output signals

Connections on resolver module

- Resolver inputs
 - X6
 - X7
 - X8
 - X9



Input and output signals

Encoder input signal on resolver modules (DIG-ENC)

- Encoder inputs
- X10

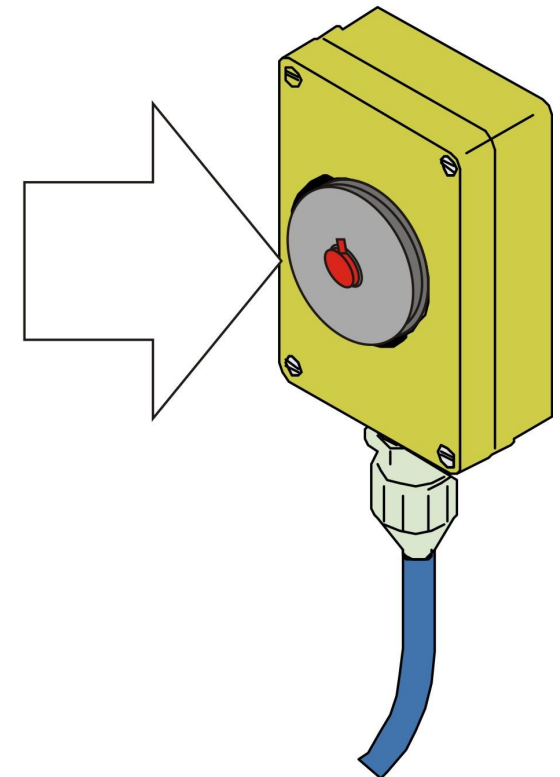
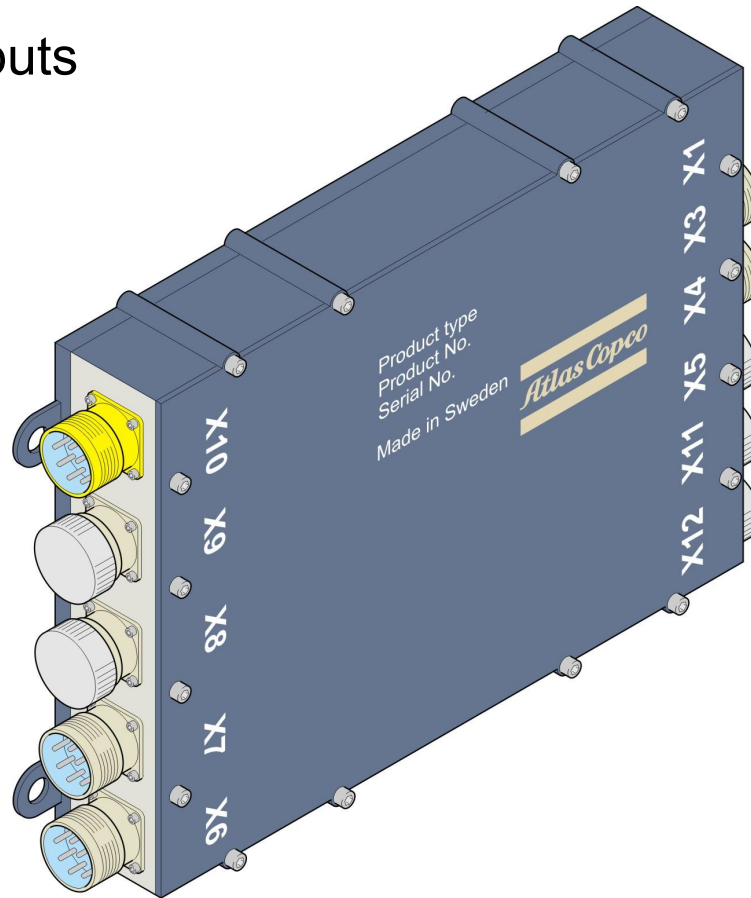

Input and output signals

Resolver input signal on resolver module (RES)

- Resolver inputs
 - X9
 - X8
 - X7
 - X6

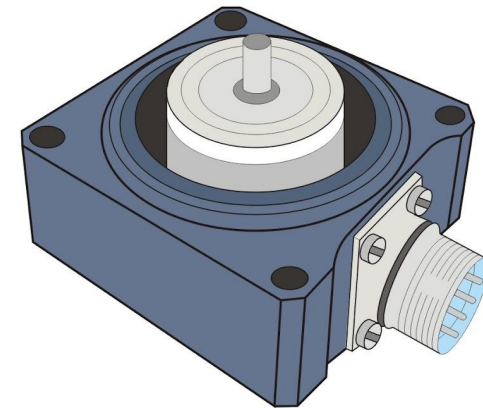
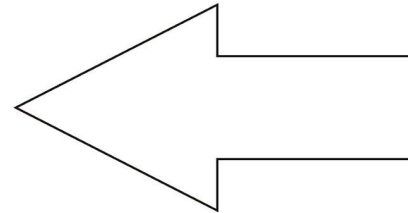
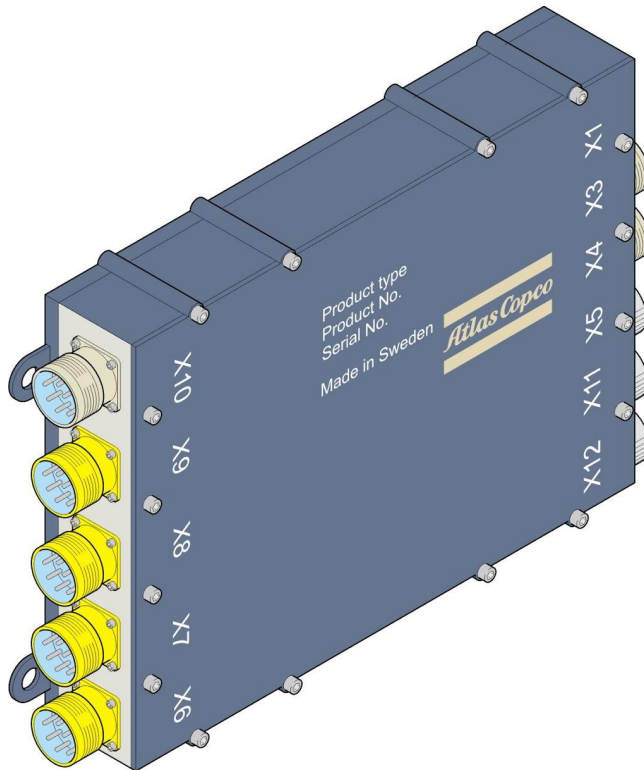

Input and output signals

Analogue input signal on resolver module (RES)

- Analogue inputs
 - X11
 - X12

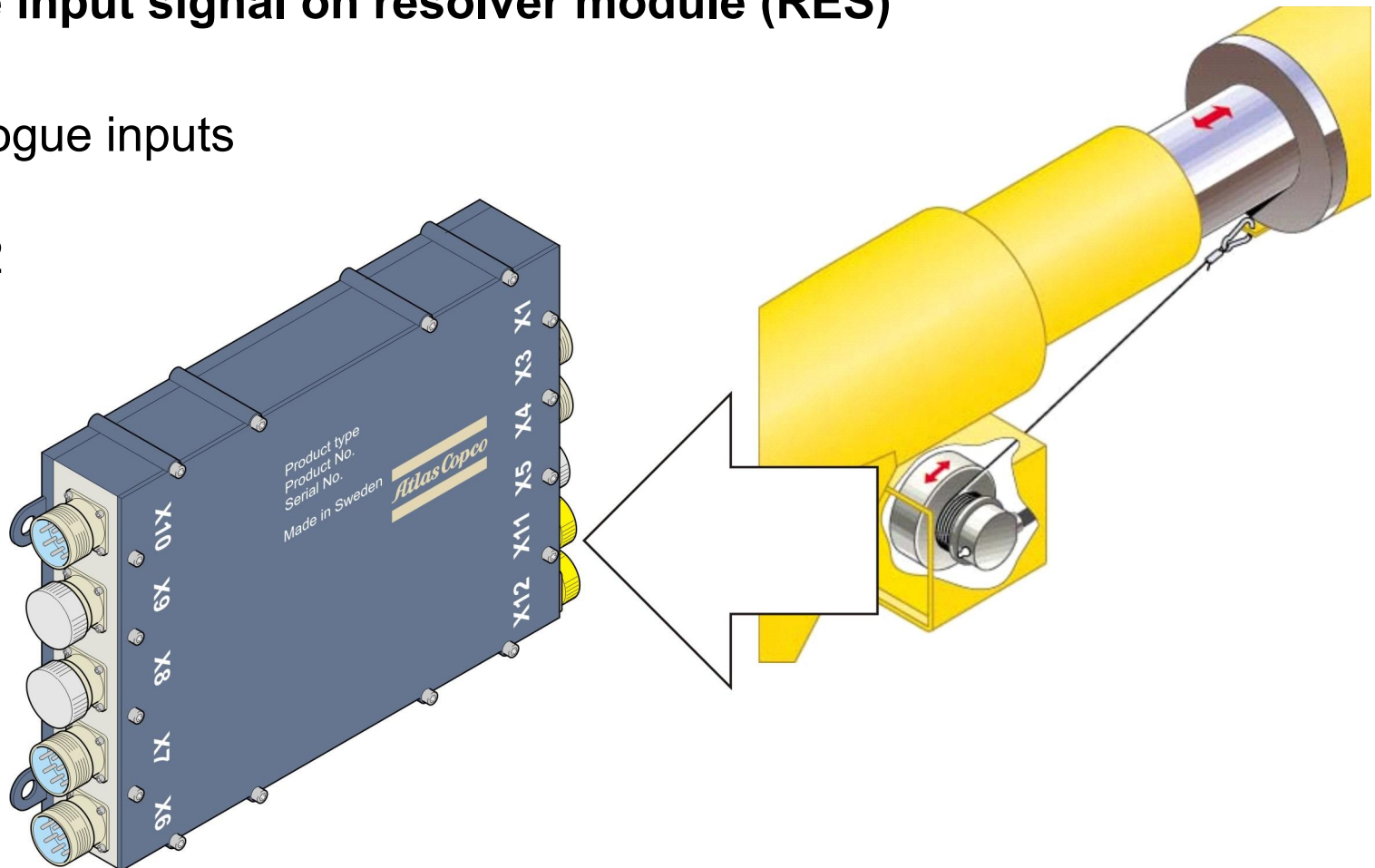

**We are committed to your
superior productivity through
interaction and innovation.**



Atlas Copco

