

Principal of geometry and Some Applications of Crystal Structure in Materials

Karimat El-Sayed

Physics Departement, Faculty of Science, Ain Shams University

What is...

Materials Science: investigation of the relationships that exist between the structure and properties of materials.

Materials Engineering: designing materials that have specific properties on the basis of structure/property relationships.

Main Idea:

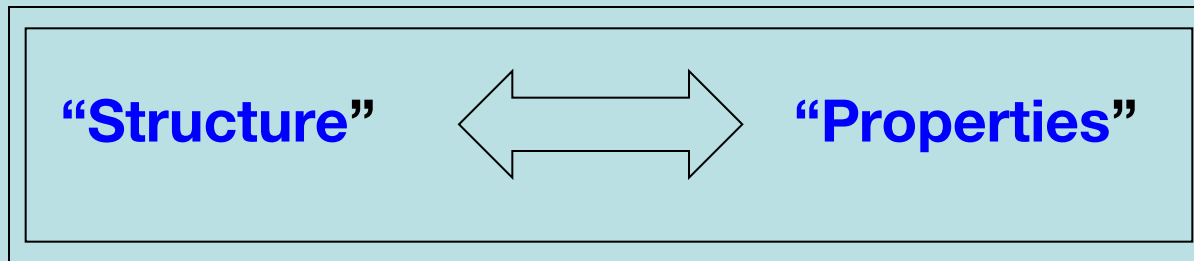

-Mechanical
-Electrical
-Thermal
-Magnetic
-Optical

Primarily concerned with study of:

- Metals/Alloys
- Ceramics/Glasses
- *Polymers**
- Biological Materials
- Composites

} "Condensed Phases"

title



Cube

Dodecahedron



Icosahedron



20 faces and 12 vertices



Octahedron

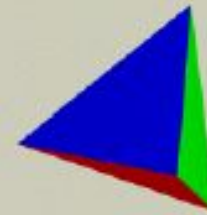

Tetrahedron

What Do We Mean by 'Structure'?

Many levels of structure:

Macroscale

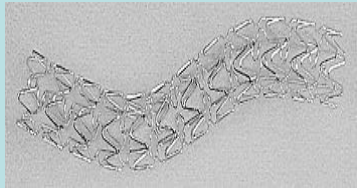

Microscale

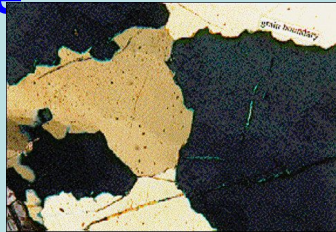

Nanoscale

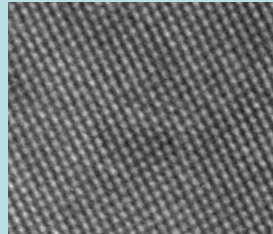

Atomic (Å)

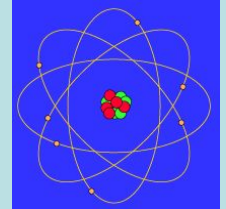
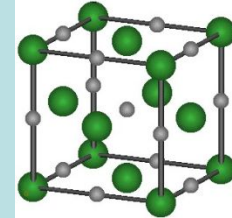

Broad range of length scales...

Most physical properties of a material are directly related to the types and arrangements of bonds in the material.

Descriptions of material structure begin at the atomic level.

ELECTRO MAGNETIC SPECTRUM

THE ELECTROMAGNETIC SPECTRUM

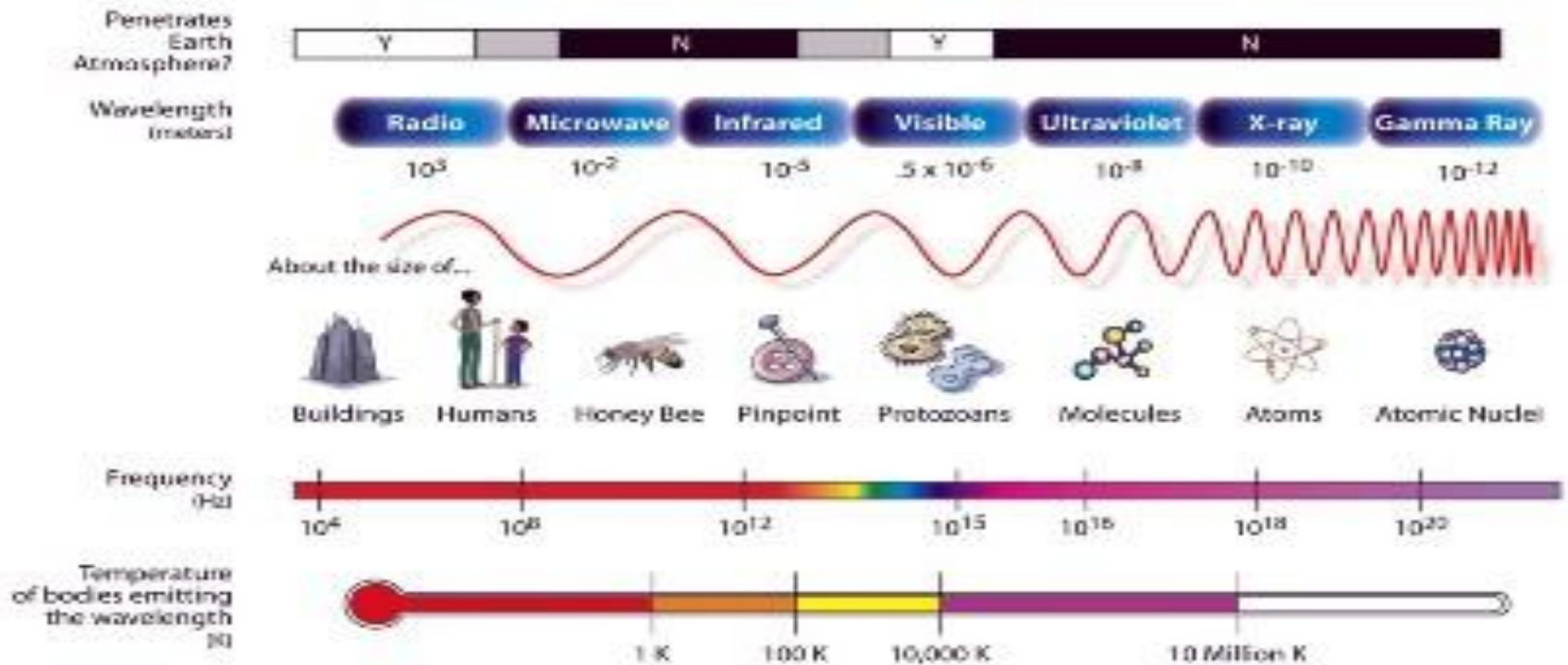

Optical Microscope and x-Ray Diffraction Image

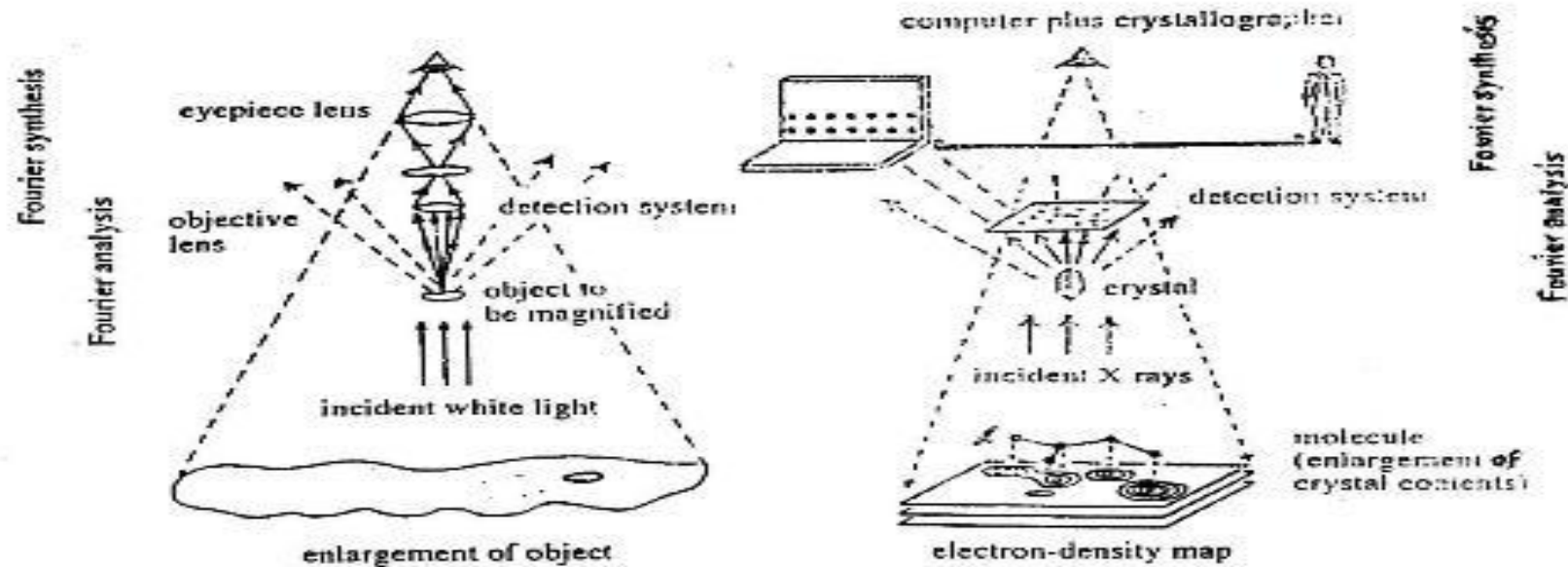
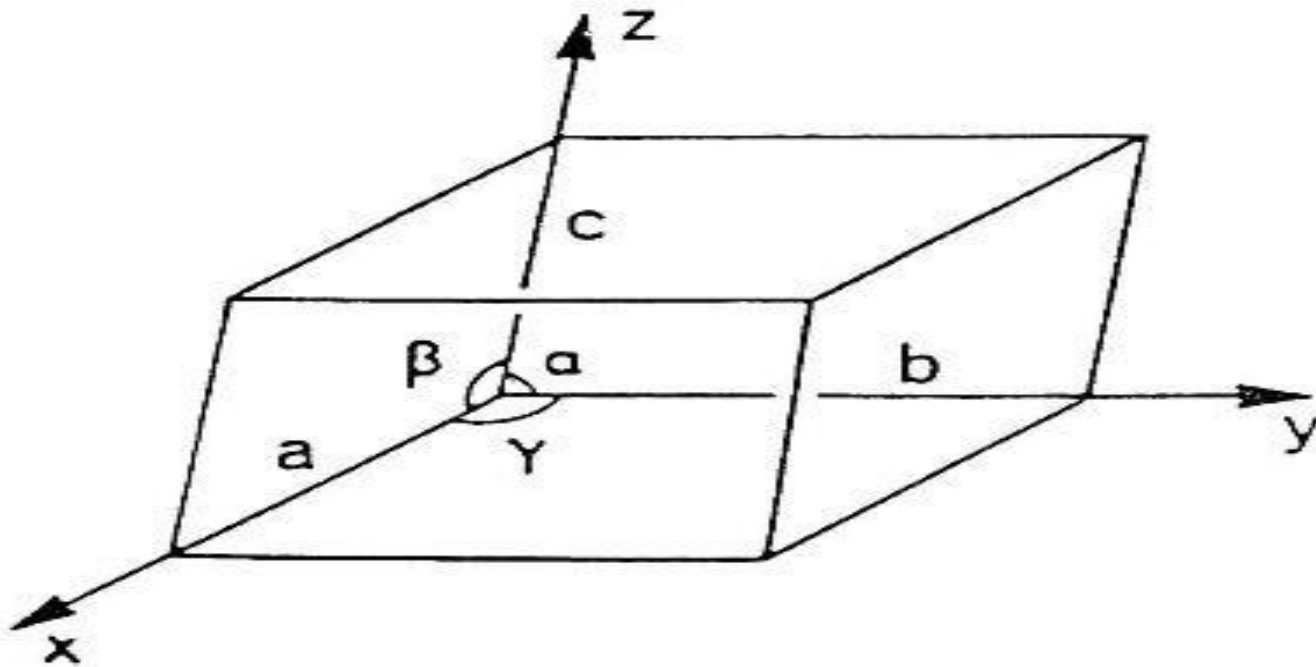

Figure 4: A comparison of the action of a microscope and the analysis of a crystal structure by X-ray diffraction. The first stage, a Fourier analysis, is analogous for both. The second stage, a Fourier synthesis, is carried out by a lens in the microscope, and by a crystallographer and computer in the X-ray diffraction analysis.

UNIT CELL

SLIDE 3 A unit cell showing axial lengths and interaxial angles. The axes are chosen in a right-handed system.



SLIDE 8 Indexing crystal faces.

Crystal faces are described in terms of Miller indices
These depend on which unit cell has been chosen

In this example the 213 plane hits the unit cell at $a/2$, b , $c/3$

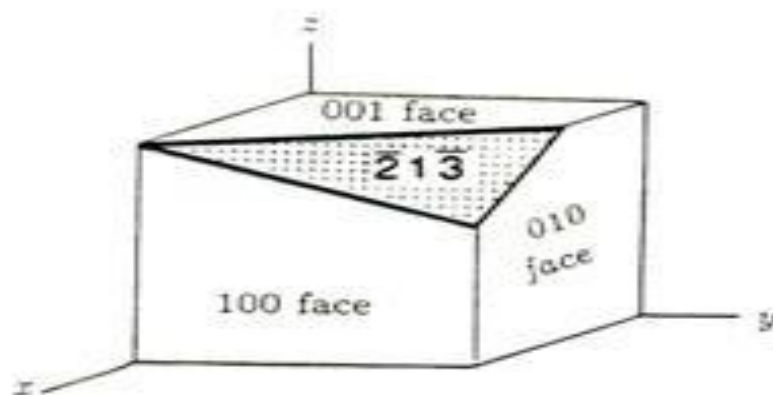
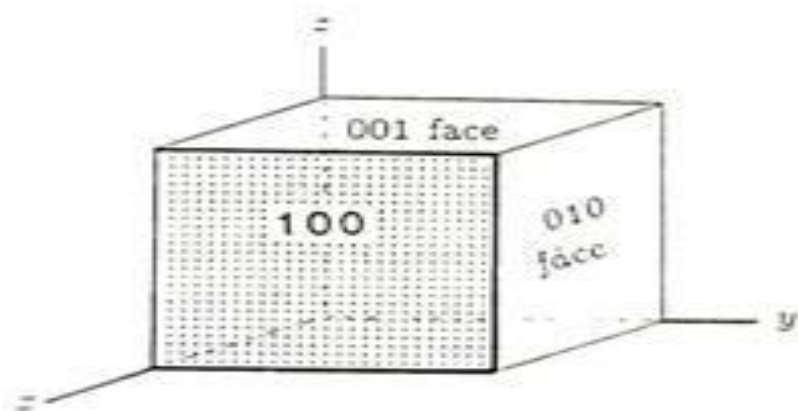
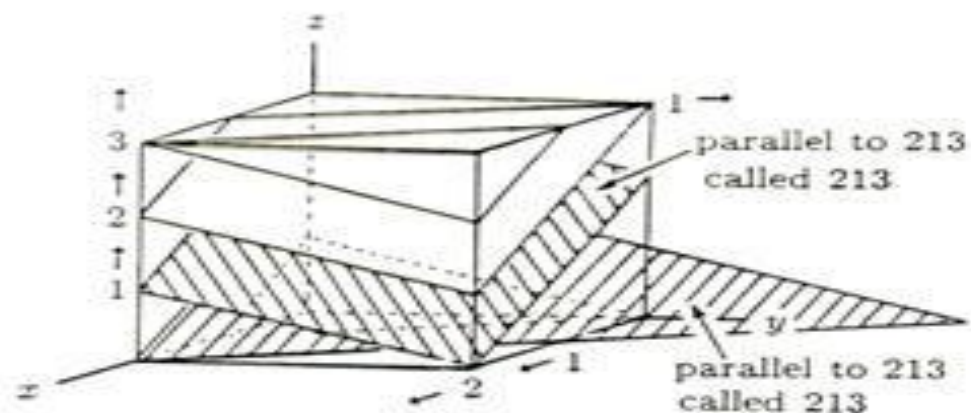
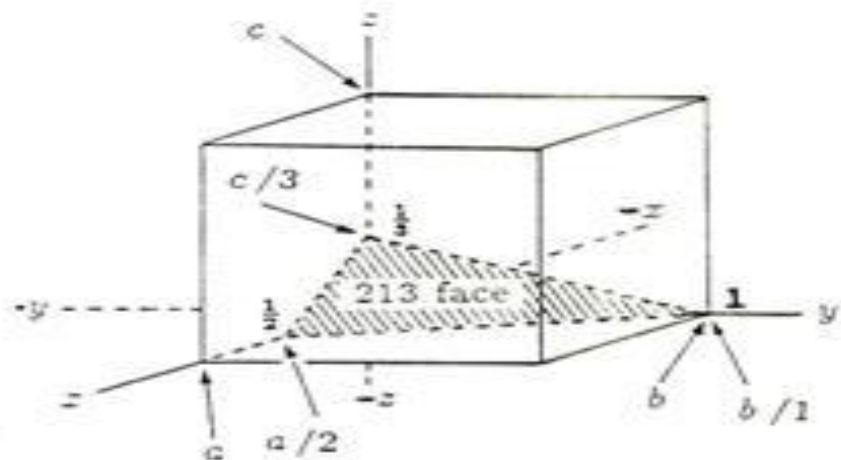

Title the 111 plane

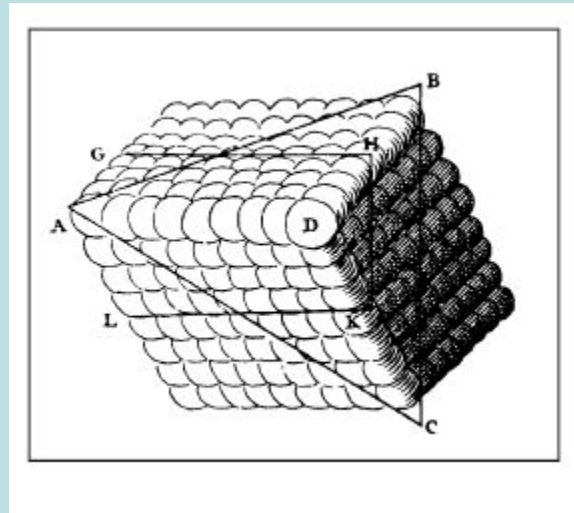

SLIDE 17 The reciprocal lattice

This is a lattice useful for understanding diffraction patterns.

The point hkl is $1/d_{hkl}$ from the origin in a direction perpendicular to the hkl planes.

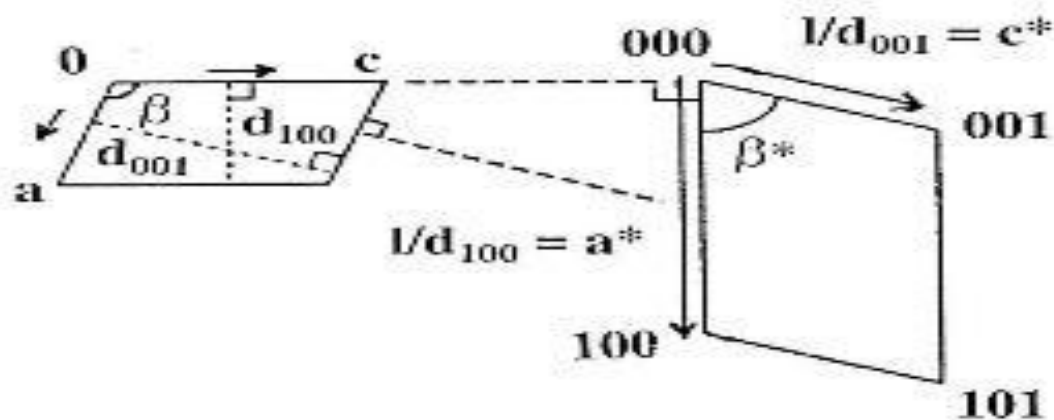
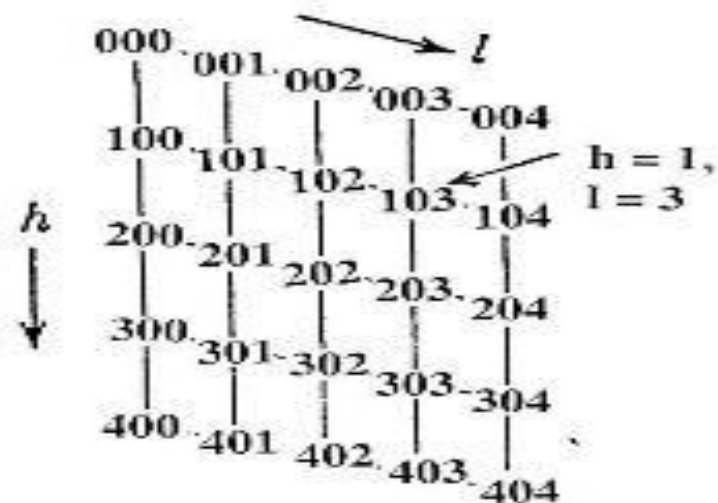
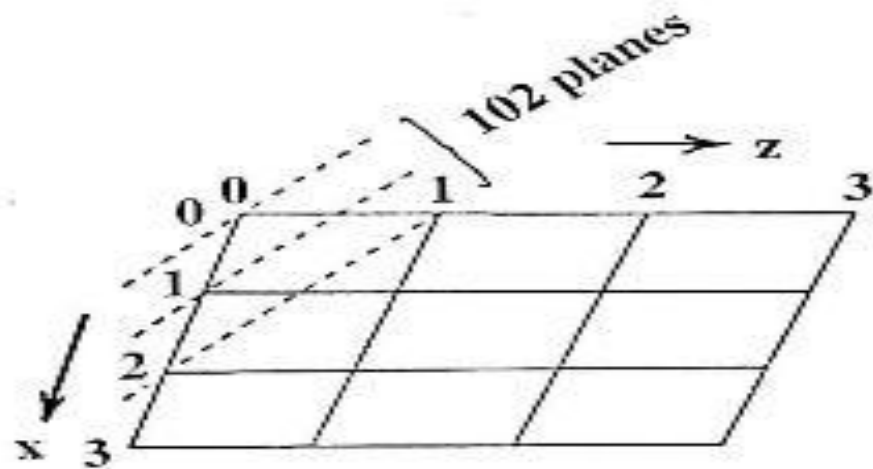

EXAMPLES OF INDEXED DIFFRACTION PATTERNS

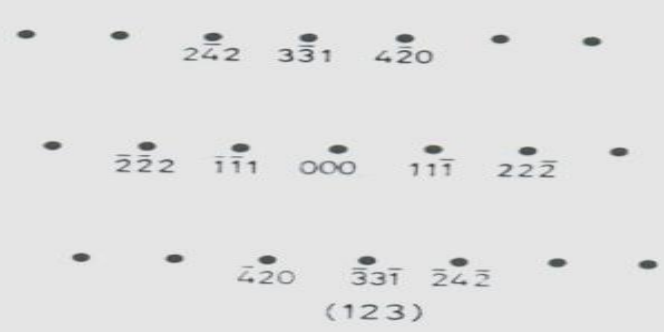
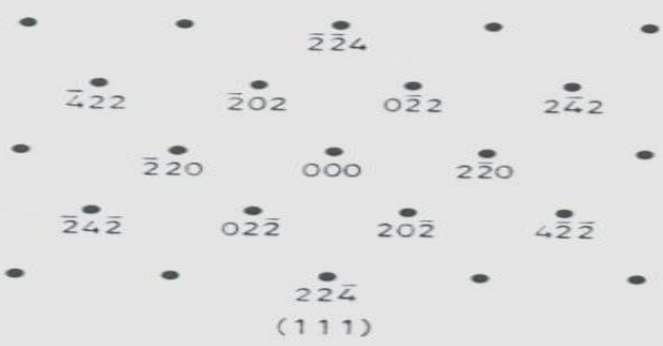
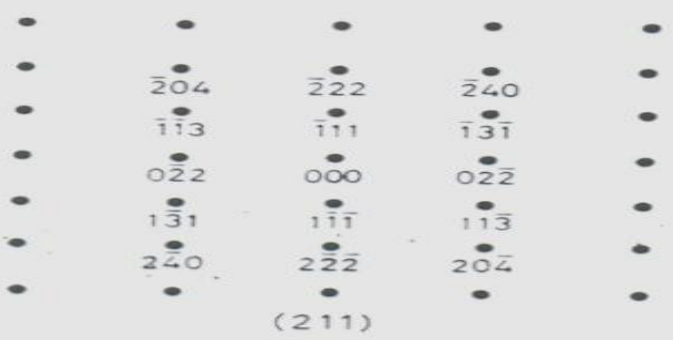
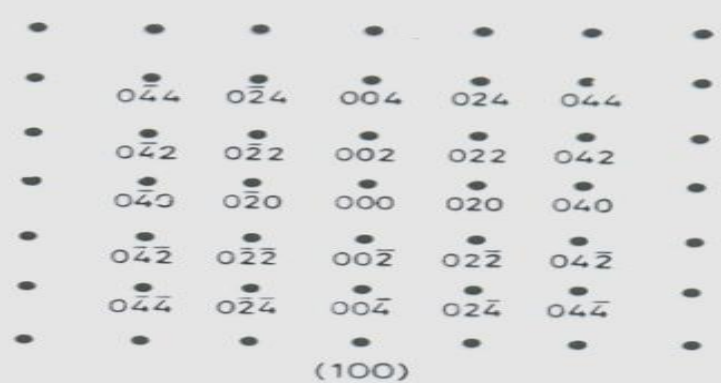
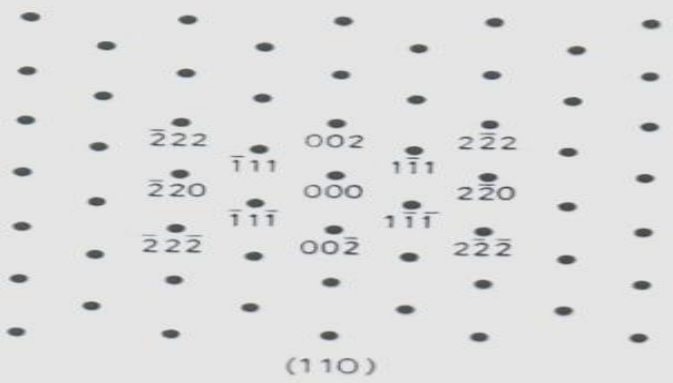

SLIDE 5 The symmetry of a cube.

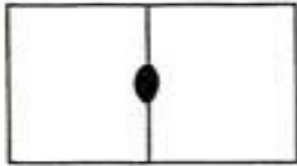

twofold axis

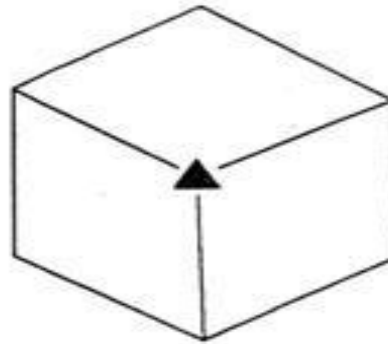

threefold axis



fourfold axis

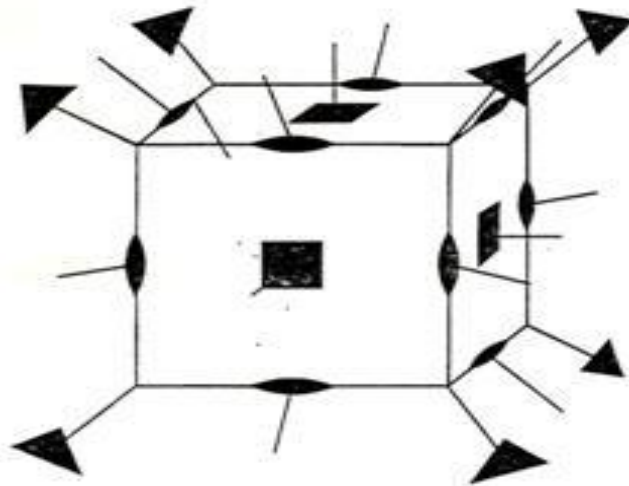

twofold axis



threefold axis



fourfold axis

Mirror



THREE FOLD AXIS

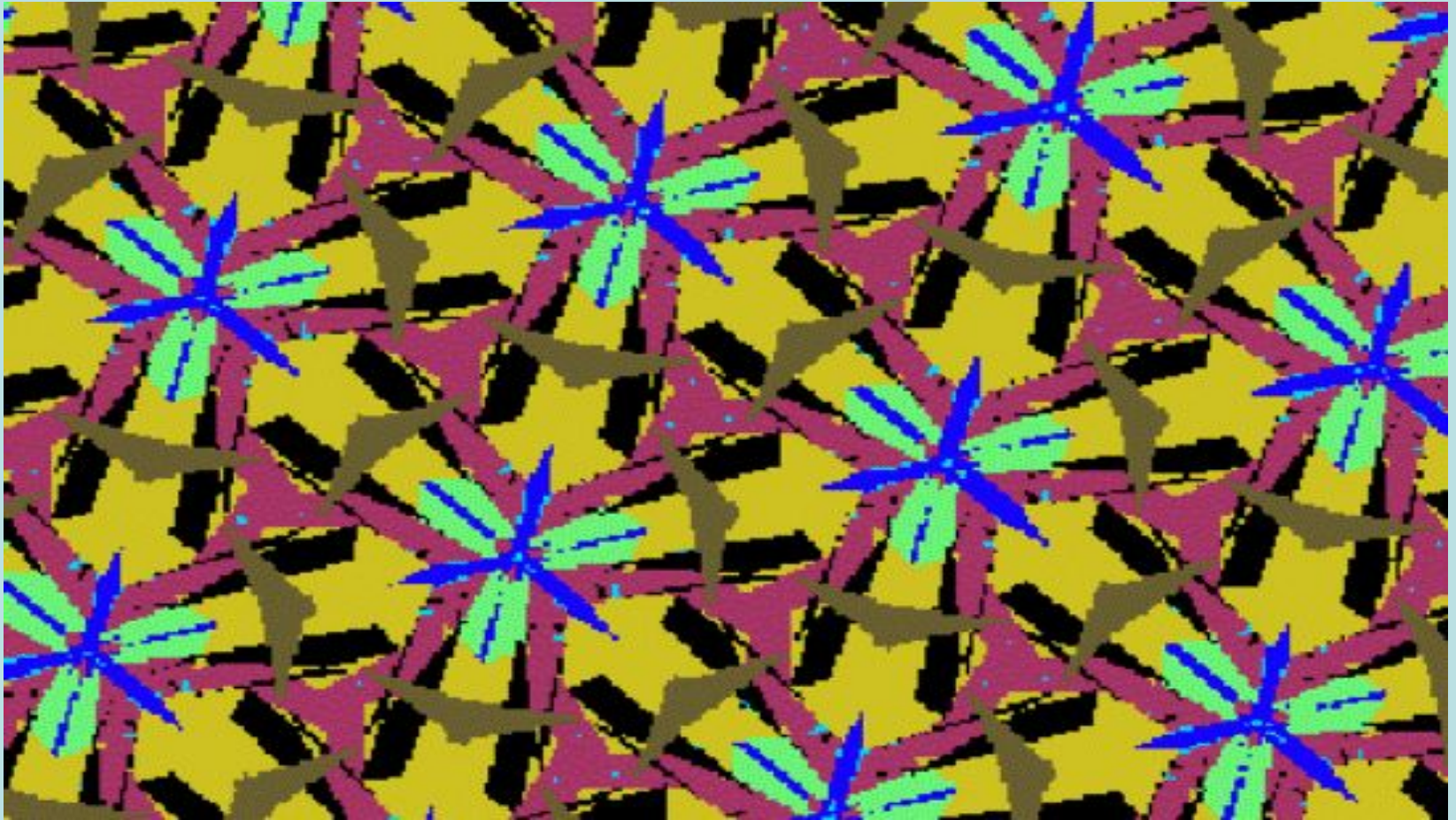

TETRAGONAL

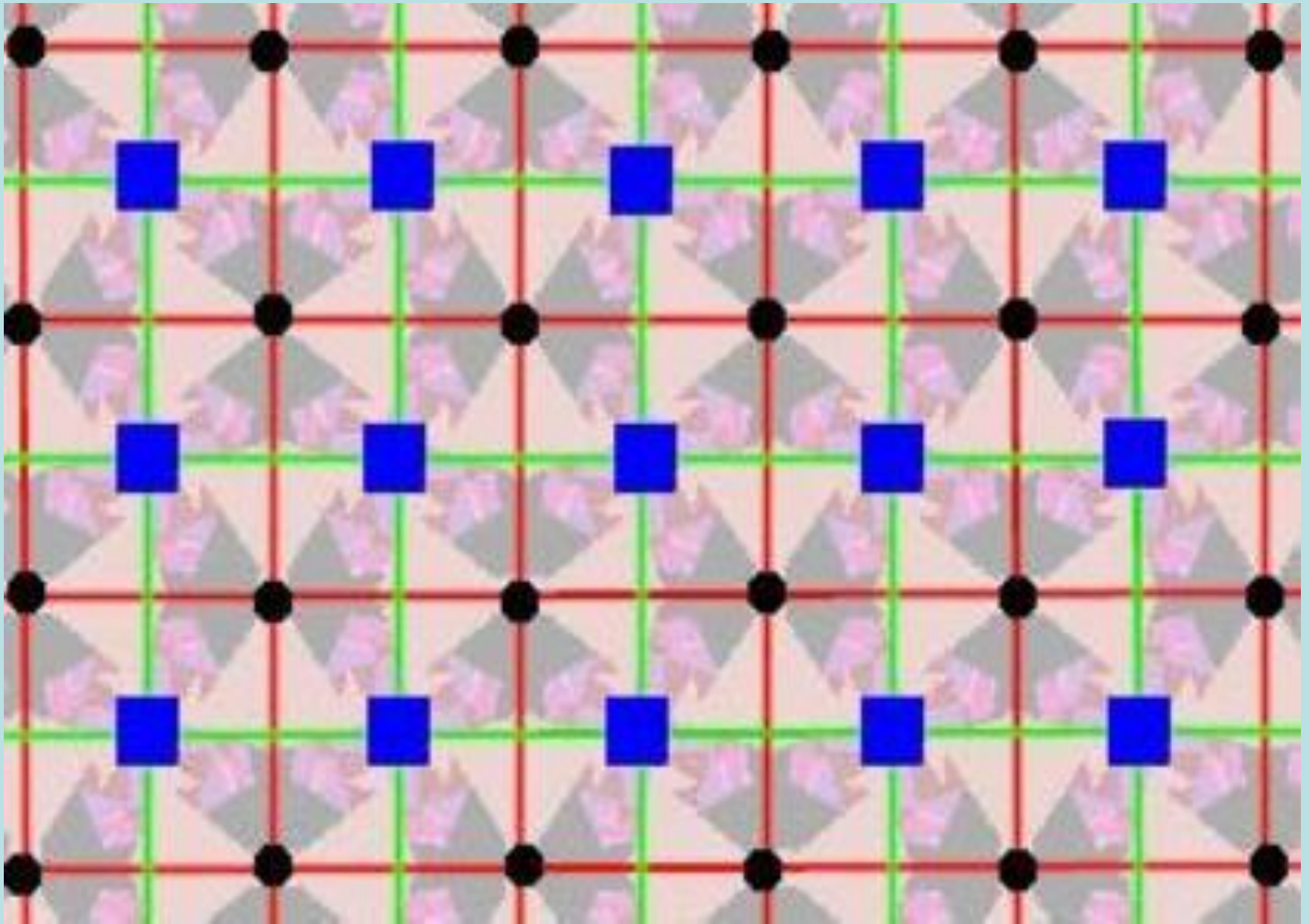

TETRAGONAL

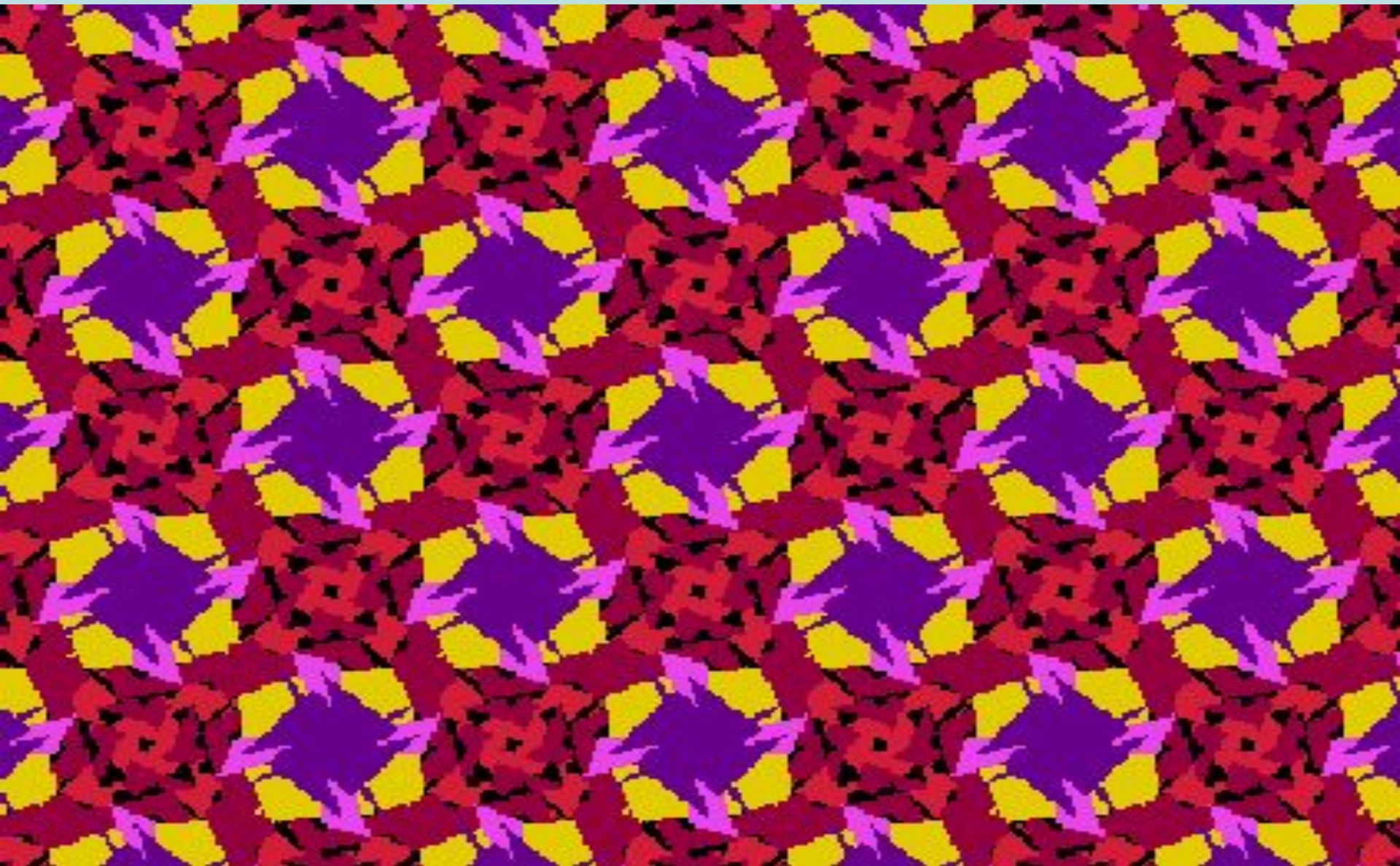

DIFFERENT FORM OF HEXAGONAL

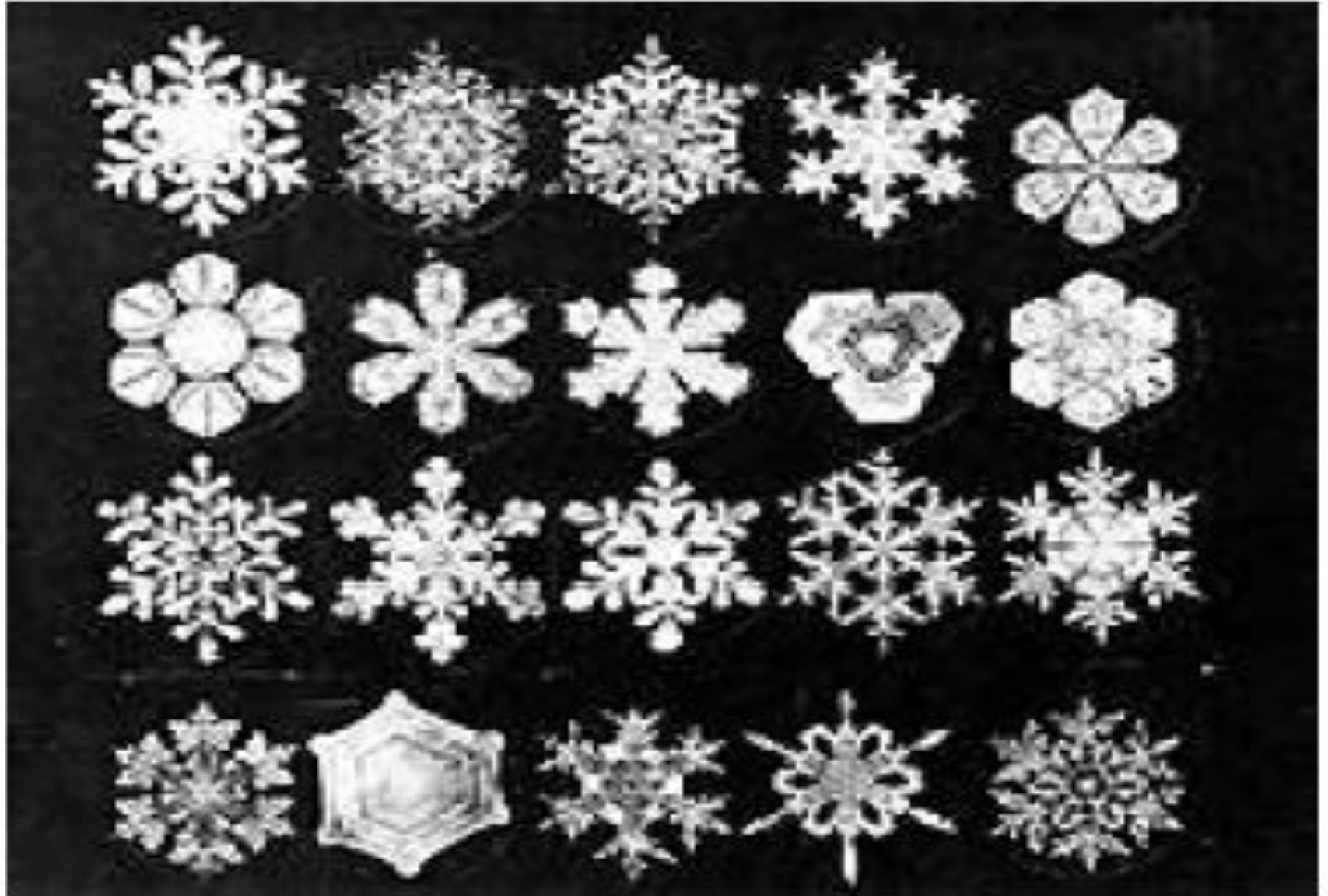

STRUCTURE SHOWING THE SIX FOLD SYMMETRY

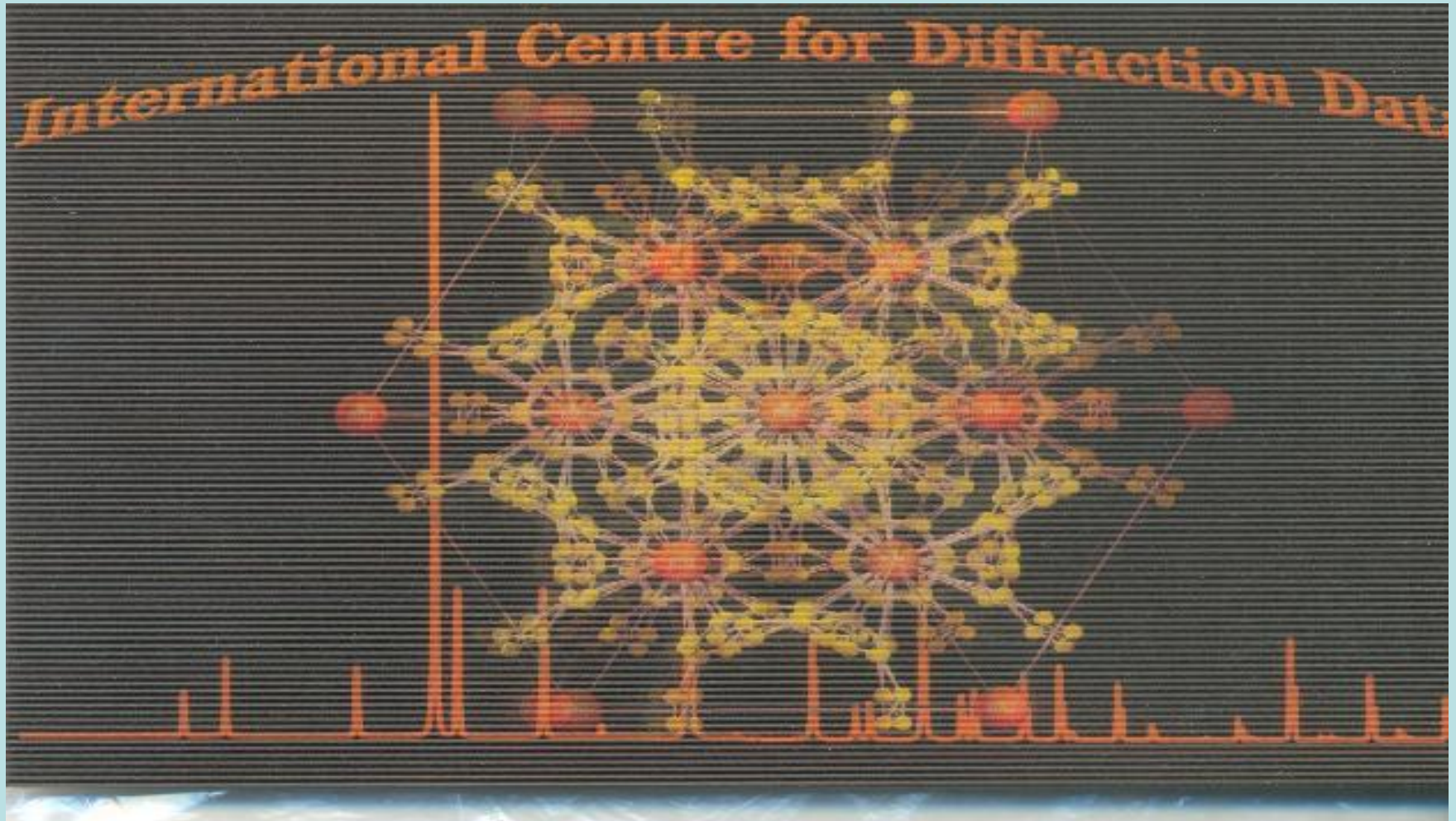

Three The Arrangement of Atoms in Dimensions

Atomic arrangements in crystalline solids can be described with respect to a ***network of lines*** in three dimensions.

The intersections of the lines are called “***lattice sites***” (or lattice points). Each lattice site has the same environment in the same direction.

A particular arrangement of atoms in a crystal structure can be described by specifying the atom positions in a repeating "*unit cell*".

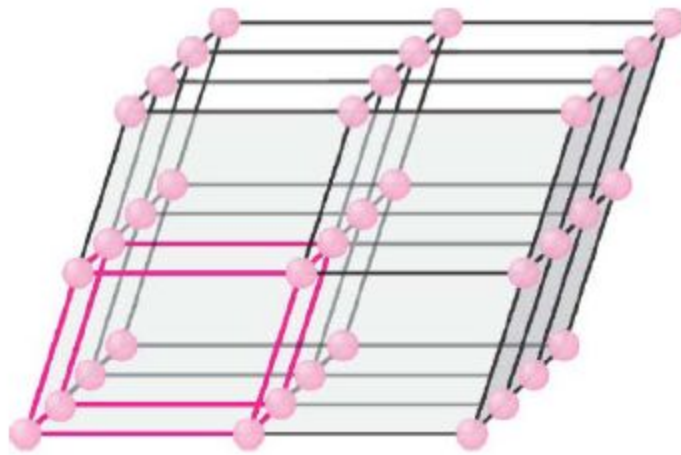

(a)

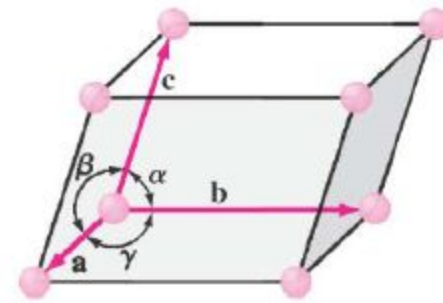

(b)

14 Bravais Lattices

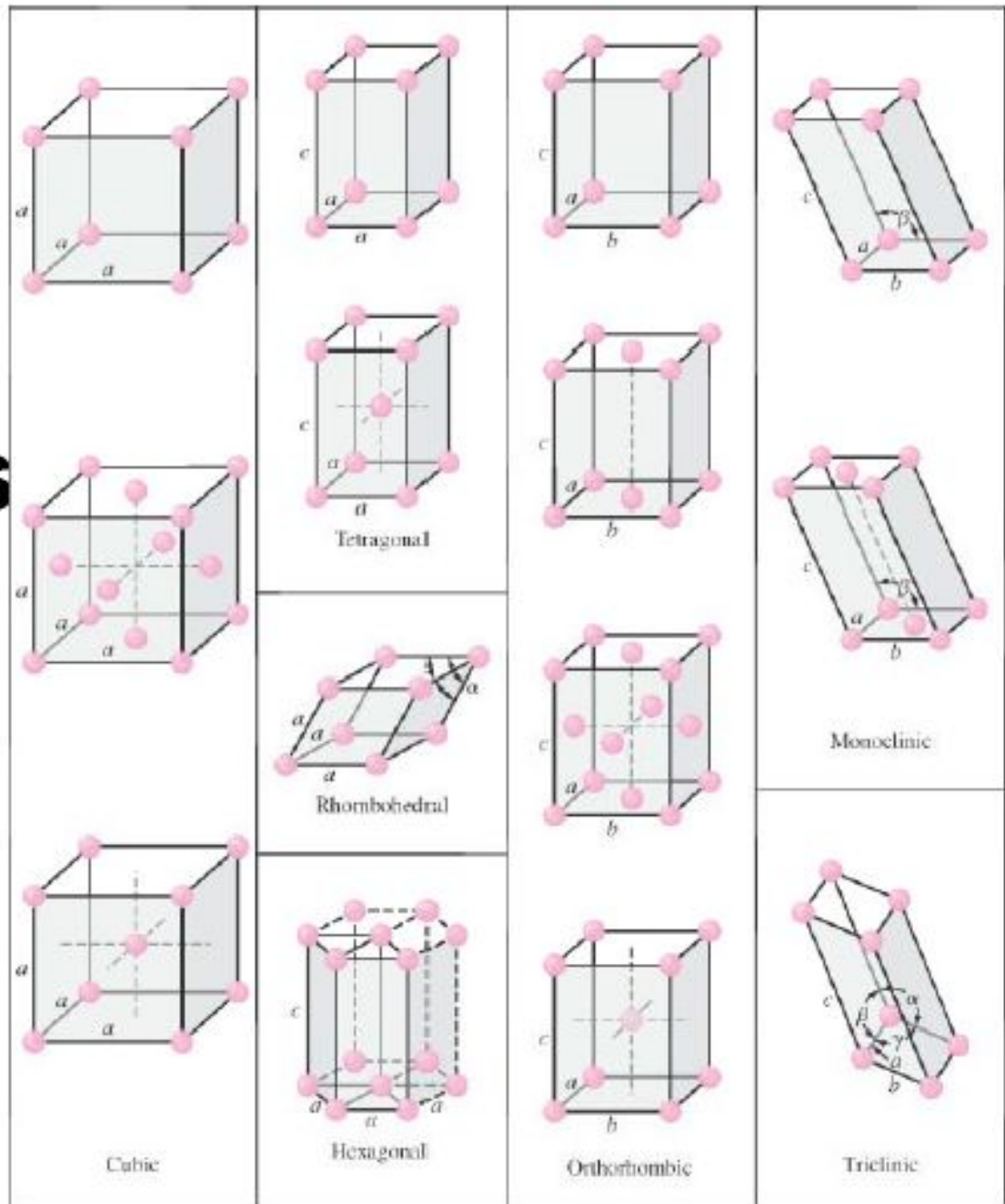

Principal Metal Crystal Structures

There are three principle crystal structures for metals:

- (a) Body-centered cubic (BCC)
- (b) Face-centered cubic (FCC)

Really important for
This course!!

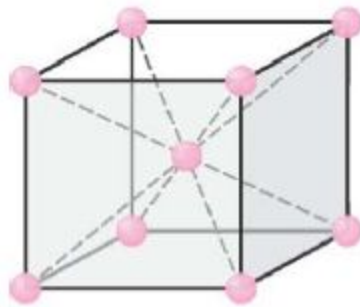

(a)

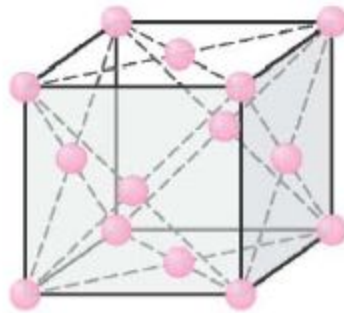

(b)

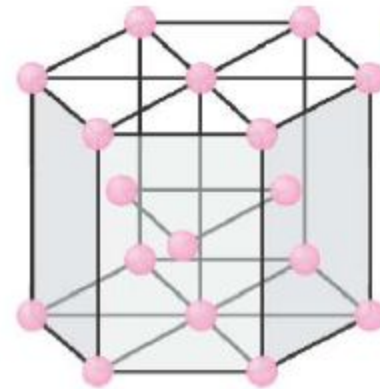

(c)

Body-centered cubic (BCC)

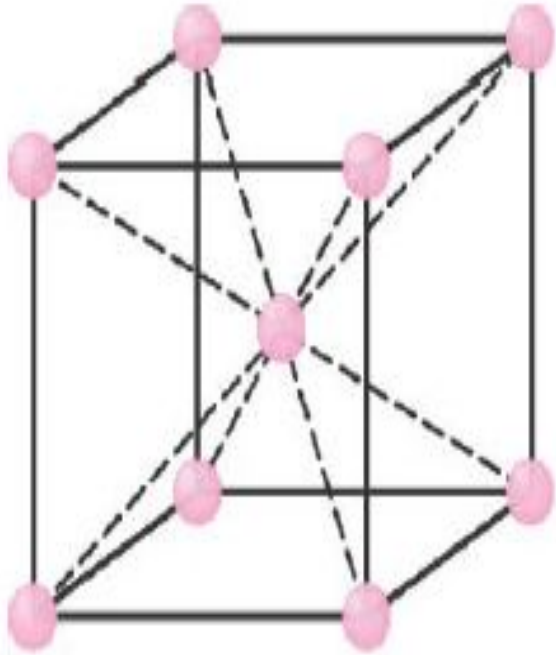

(a)



(b)

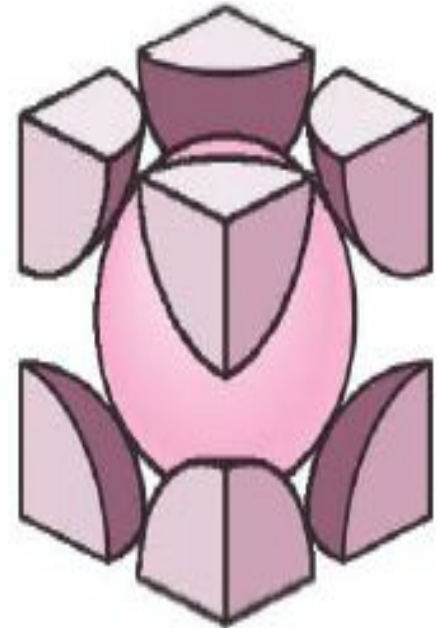

(c)

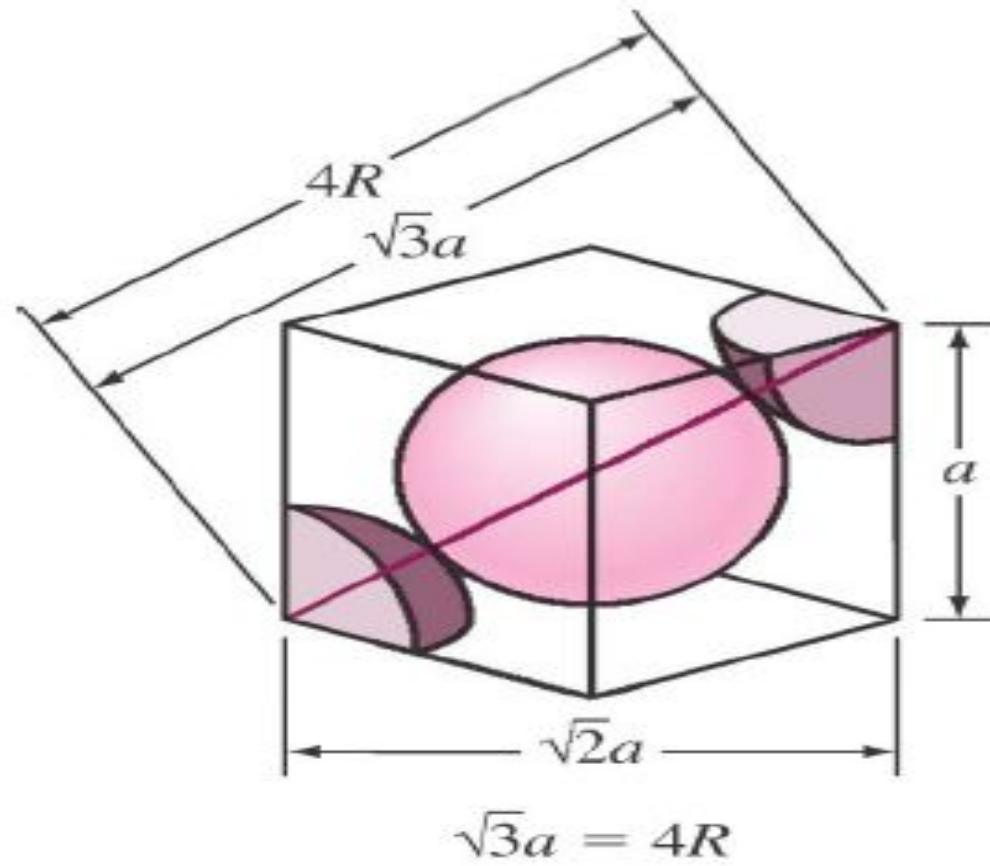

FCC

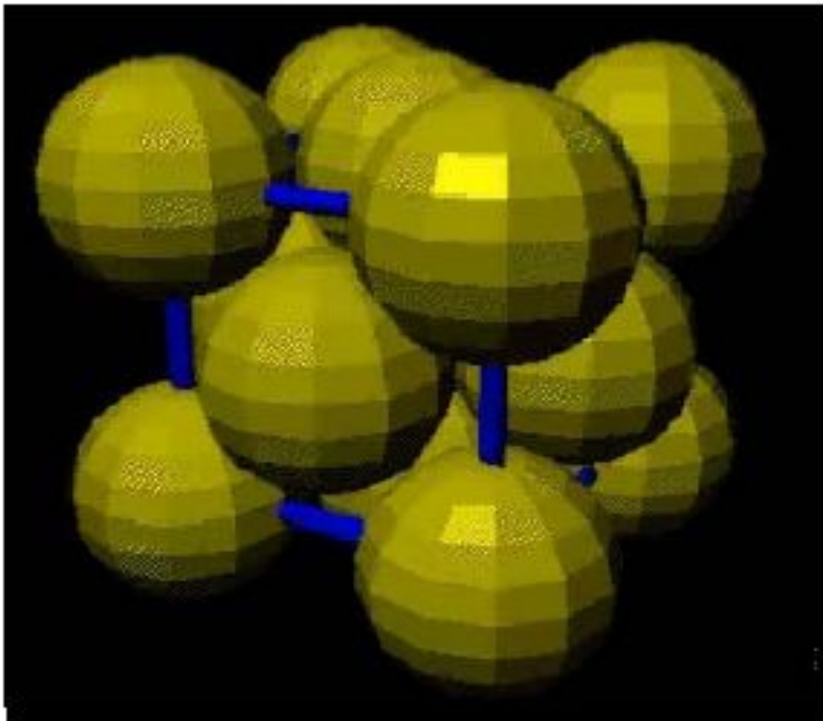

Geometry of the FCC Structure

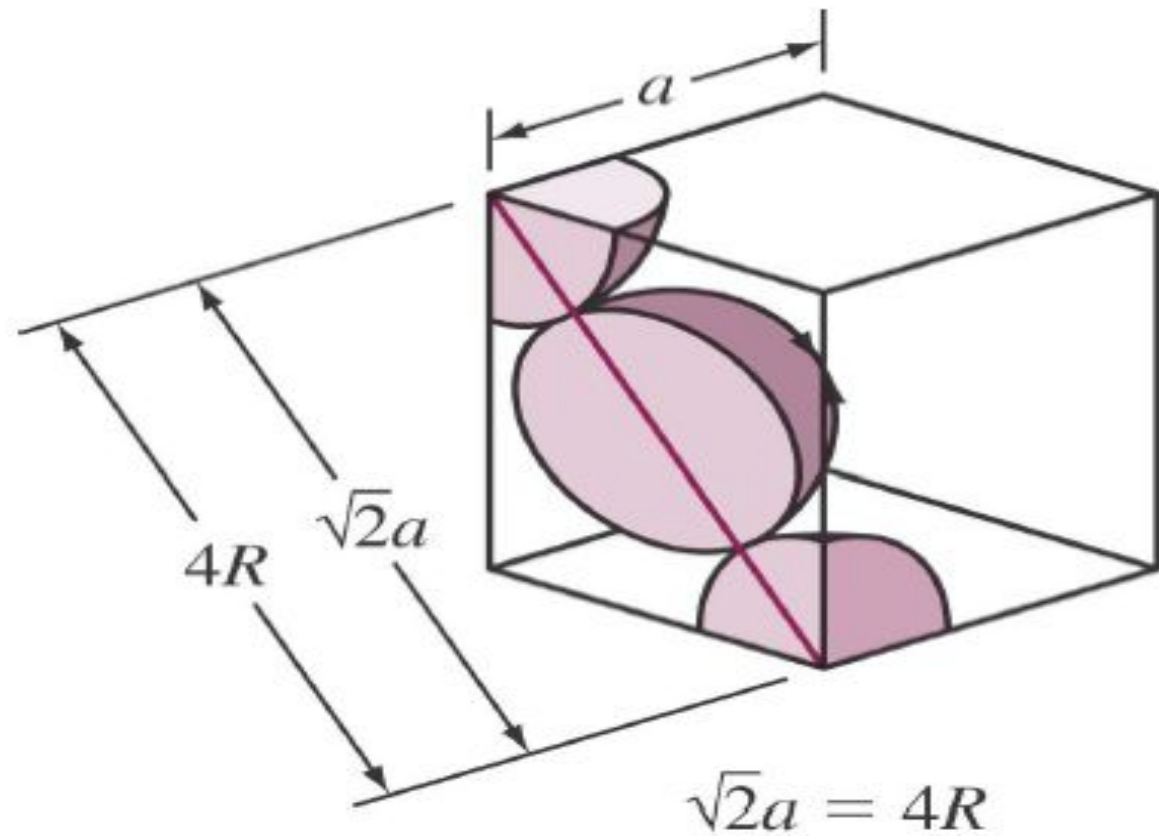

Hexagonal close-packed (HCP)

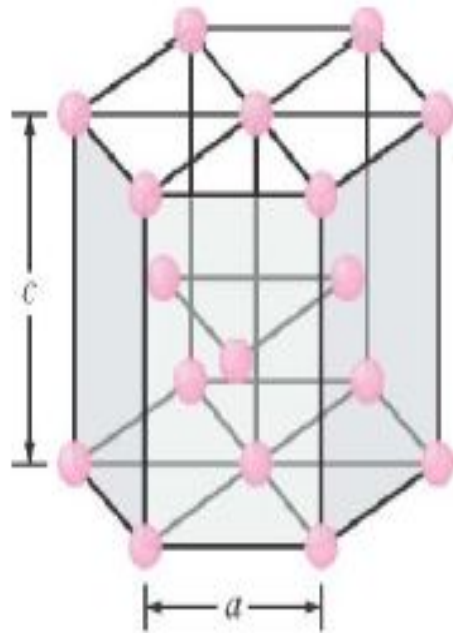

(a)



(b)



(c)

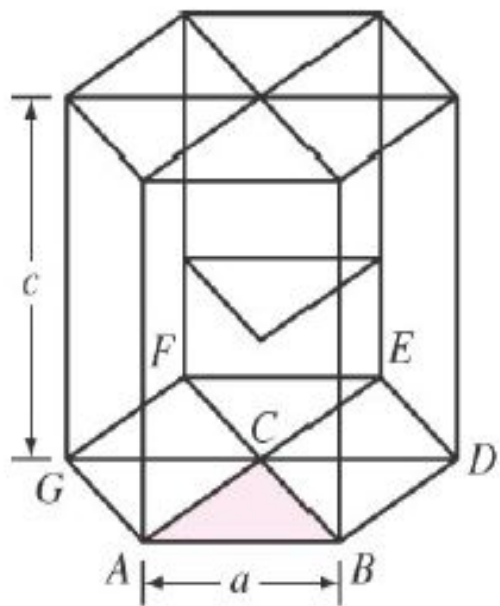

(a)

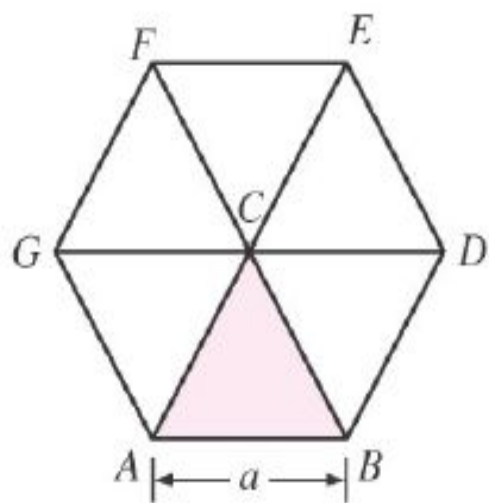

(b)

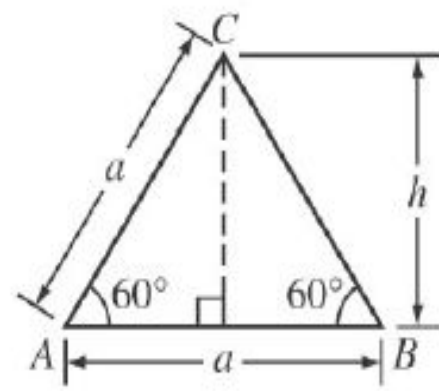

(c)

Relationships

Simple cubic & BCC

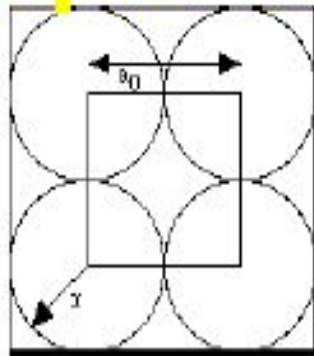

$$a = 2r$$

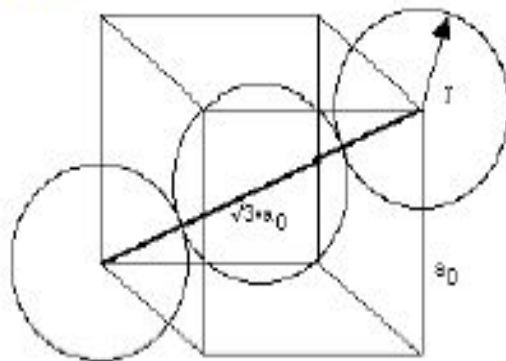

$$\sqrt{3} \cdot a = 4 \cdot r$$

FCC

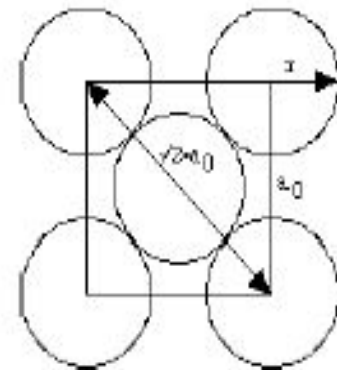

$$\sqrt{2} \cdot a = 4 \cdot r$$

INTERSTITIAL SPACES

4

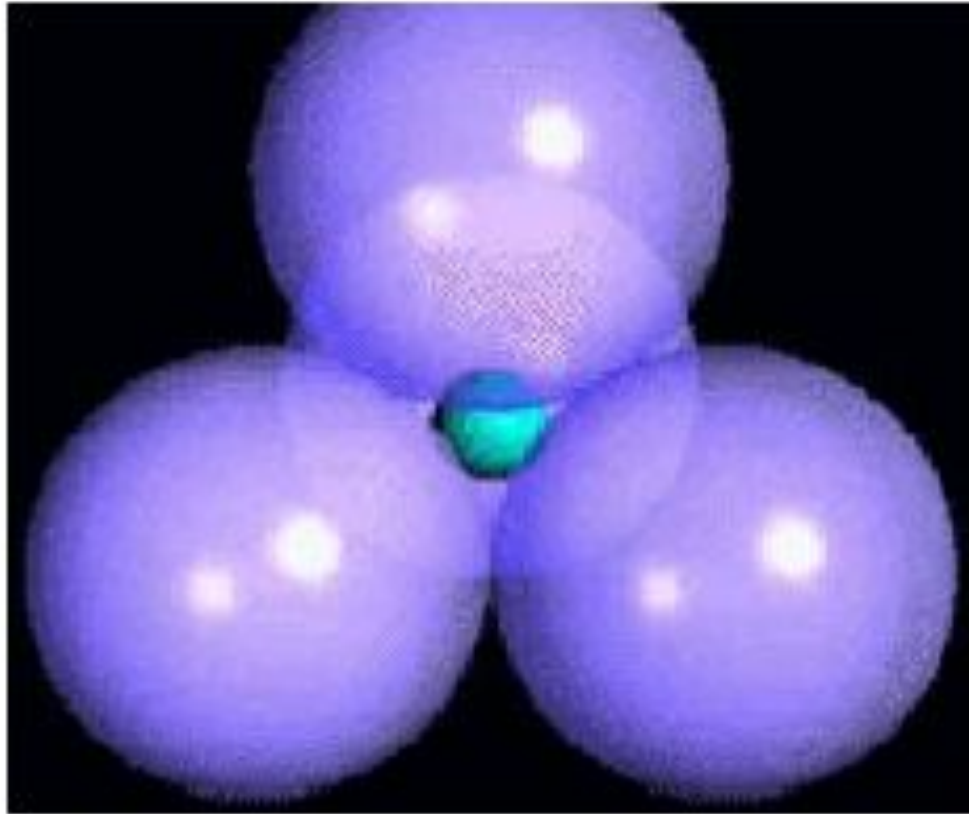

6

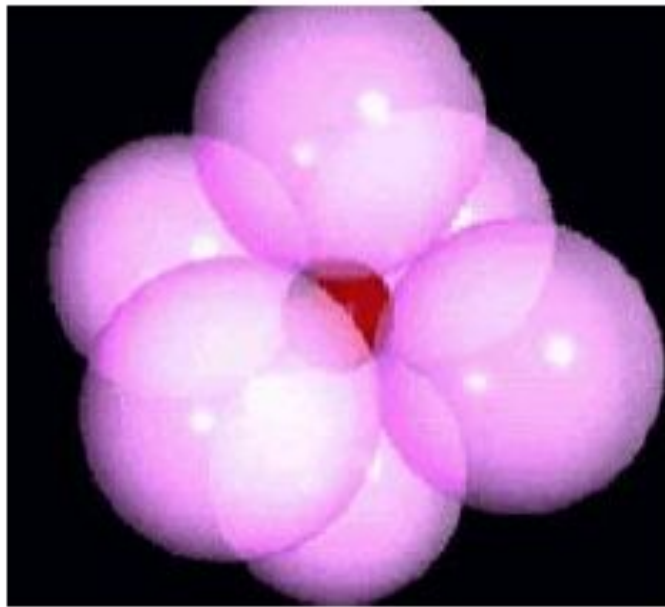

The C₆₀ or 'Buckball' belongs to a very small set of known molecules with icosahedral symmetry

