

HW Repair Guide SM-G7102 (Galaxy Grand 2)

1. All functionality, features, specifications and other product information provided in this document including, but not limited to, the benefits, design, pricing, components, performance, availability, and capabilities of the product are subject to change without notice or obligation. Samsung reserves the right to make changes to this document and the product described herein, at anytime, without obligation on Samsung to provide notification of such change.
2. In data of our company, important management / technical information is included, and if it is leaked, loss can happen in various aspect such as closing a technology gap, increasing ability to respond. Therefore, it is strictly prohibited from information leak or forwarding this material, and if leak of management / technical information due to disobeying the law happens, it can be severely punished in accordance with information protection rule of our company.

1. Introduction of GRAND2 3G

2. Service Guide

- RF calibration
- IMEI writing
- Boot Recovery

3. Repair Guide

- Assembly & Disassembly
- Electronic Components
- SMD parts
- Trouble Shooting



Samsung
GALAXY GRAND 2

4. Q&A

- **Specification**

Item	Specification
AP	One chip solution
CP	MSM8226 A7 Cortex Quad Core @ 1.2GHz
OS	Android 4.3 (Jelly Bean MR2)
Memory	8GB (eMMC) + 1.5GB (LPDDR2, POP)
Display	5.25" HD (TFT)
Camera	8M AF + LED Flash, 1.9M FF
Sensor	Proximity, Light, Accelerometer, Hall Sensor
FM Radio	O
Connectivity	BT4.0, WiFi a/b/g/n
GPS	A-GPS + GLONASS
Battery	2600mA
Speed	HSPA+ 21Mbps

- **Features**

Optimal Wide View

- **Satisfying Viewing Experience**
- **Maximize Every Inch**

1. Optimized for Media playing

- ✓ 16:9 HD display
- ✓ Perfect Ratio for Movie

2. Big Screen Experience

- ✓ Larger Viewing Area
- ✓ Clearer

3. Easy Multi Tasking

- ✓ Multi Window & Easy Sharing

Smart Service for Smart Life

- **Entertaining and Fun**
- **Refined Usability**

1. Premium Experience

- ✓ S View Cover
- ✓ Perfect Ratio for Movie

2. Fun

- ✓ Sound & Shot
- ✓ Group Play
- ✓ S Translator
- ✓ Story Album

Introduction of GRAND2 3G (3/3)



Galaxy Grand	Category	Galaxy Grand2
5.01" TFT WVGA (800 x 480)	Lager and High Resolution Display	5.25" TFT HD (1280 x 720)
8M w/LED	Camera	8M w/LED, BIS, Zero Shutter Lag
Broadcom Capri ARM Coretex-A9 Dual 1.2GHz	Application Processor	Qualcomm MSM8226 ARM Coretex-A7 Quad 1.2GHz
2100mAh	Battery	2600mAh
GFF	Slim TSP	Slim GFF
1GB DDR2 8GB eMMC	Memory	1.5GB DDR2 8GB eMMC
2G EDGE Rx Quad 3G HSPA+ 21Mbps Triple (1,2,8)	Network	2G EDGE Rx Quad 3G HSPA+ 21Mbps Quad(1,2,5,8)

★ For GRAND2(SM-G7102), new IF cable should be used for IMEI writing and Calibration.
(Detailed information : Refer SVC Bulletin (12-37) New IF Cable Guide.)

1. Run Baroserver program.

- Extract “BaroServer_Ver_1.0.6.zip” and Run “setup.exe”
- Click Next to install the program. Run BaroServer Launcher at the desktop.
- Enter ‘Assistant Server IP’, same as ‘Host Server IP’.
- Check SVC Only (5555) option and input password.
- Click ‘START’ button and check if “Running” message appears.

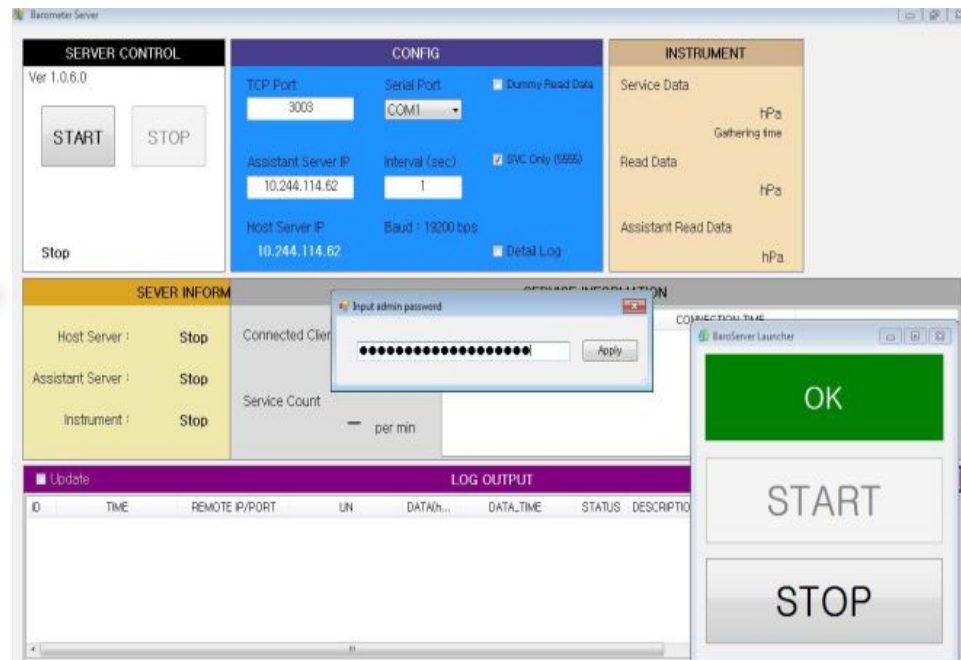
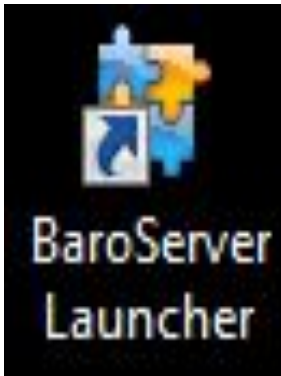

2. Run Calibration program

Category	Filename	Remark
Launcher	DASEUL_Launcher_v3.0.20.exe	
Runtime file	DASEUL_CAL_ALL_Runtime_3.1.93.0_r00061.CAB or later version	Folder Name : SM-G7102 (under Launcher folder)
Model File	SM-G7102_COMMON(CSC)_IMEI_Ver_3.1.92.0.CAB or later version	Folder Name : SM-G7102 (under Launcher folder)

IMEI Writing (1/4)

★ For GRAND2 3G(SM-G7102), new IF cable should be used for IMEI writing and Calibration. (Detailed information : Refer SVC Bulletin (12-37) New IF Cable Guide.)

1) Run Daseul Program for IMEI Writing

Category	Filename
Launcher	DASEUL_SVC_Launcher_v3.0.20.exe
Runtime File	DASEUL_IMEI_ALL_Runtime_3.1.93.0_r00074.CAB or later version
Model File	SM-G7102_COMMON(CSC)_IMEI_Ver_3.1.92.0.CAB or later version

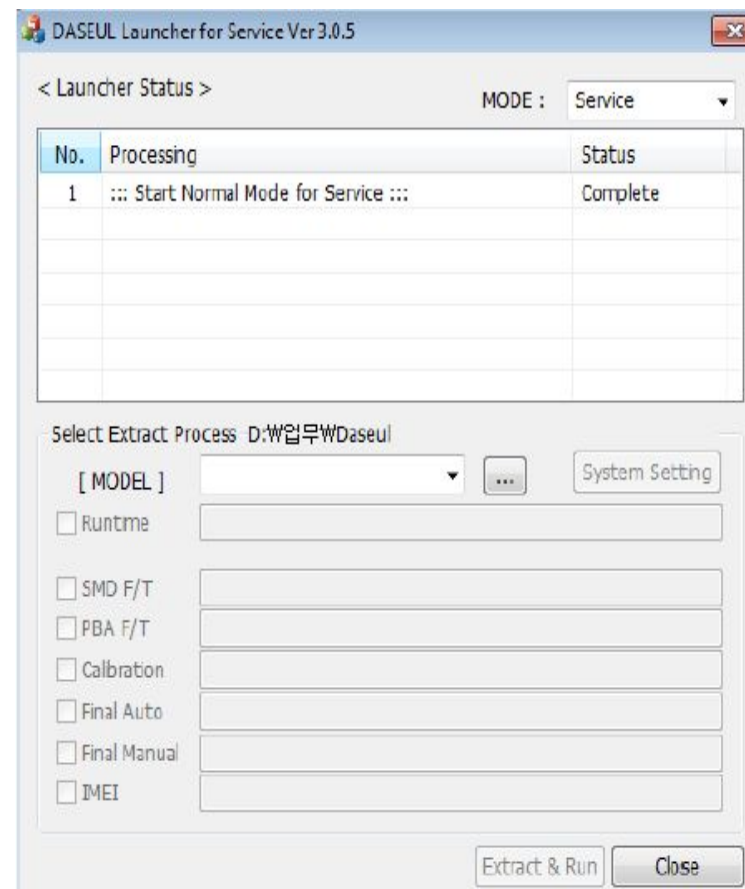

IMEI Writing (2/4)

2) Select MODE as 'Service', Model folder as 'SM-G7102', check IMEI option and click System Setting button.

3) Check 'IMEI Write' and 'IMEI Check' option, and click 'IMEI SVC & Repair Option' to check 'SVC' option.

The image shows two screenshots from the DASEUL software interface. The left screenshot is the 'DASEUL Launcher for Service Ver 3.0.5' window. It features a 'MODE' dropdown menu set to 'Service' (1), a 'MODEL' dropdown menu set to 'SM-G7102' (2), and a 'System Setting' button (3). The 'IMEI' checkbox is checked (4). The right screenshot is the 'Set System Configuration' dialog box. It shows a list of test processes on the left, with 'IMEI Write' and 'IMEI Check' checked. A modal dialog 'IMEI SVC & Repair Option' is open, with the 'SVC' checkbox checked. At the bottom of the main dialog, the 'IMEI SVC & Repair Option' button is highlighted.

IMEI Writing (3/4)

- 4) Click 'Hardware Config' option.
- 5) Click 'Port Setting' in the phone option, and select correct port for IMEI writing.
- 6) Click Save and OK to enter IMEI writing program.

The screenshot displays the 'Set System Configuration' software interface. The main window is titled 'Set System Configuration' and contains several sections: 'Test Process', 'Test Condition', 'System Config.', and 'Operation Condition'. The 'Hardware Config' button is highlighted with a red box. A secondary window titled 'Set IO BUS Configuration' is open, showing 'Phone IO Bus Setting' with a table of port configurations and a 'SAVE' button highlighted with a red box.

Set System Configuration - System Config. Section:

- Language: English
- Line Name: LINE(temp)
- Line Type: Block Cell
- # of Phone: 1
- Start Number of Jig: [Empty]
- IP Address: 10.244.114.62
- SKD Mode:

Set IO BUS Configuration - Phone IO Bus Setting Section:

No.	Port #1
1	34

Common Settings:

- BaudRate: 115200
- Data Bit: 8
- Parity: No
- Stop Bit: 1

Buttons: Model Information, Hardware Config, Port Setting, SAVE, Cancel, OK, RUN SeeLog, IMEI SVC&Repair Option, Process Order.

IMEI Writing (4/4)

- 7) Enter IMEI number and click 'Apply' button.
- 8) Click 'Model Info' button and input 'SKU_CODE' and 'BUYER', then click Save.
- ❌ SKU_CODE can be found in HHPsvc > ESN/IMEI Review
- 9) Click 'Start' button and Input 'User ID' and 'Password'.
- 10) Click 'Login' button and connect the phone to Anyway JIG.

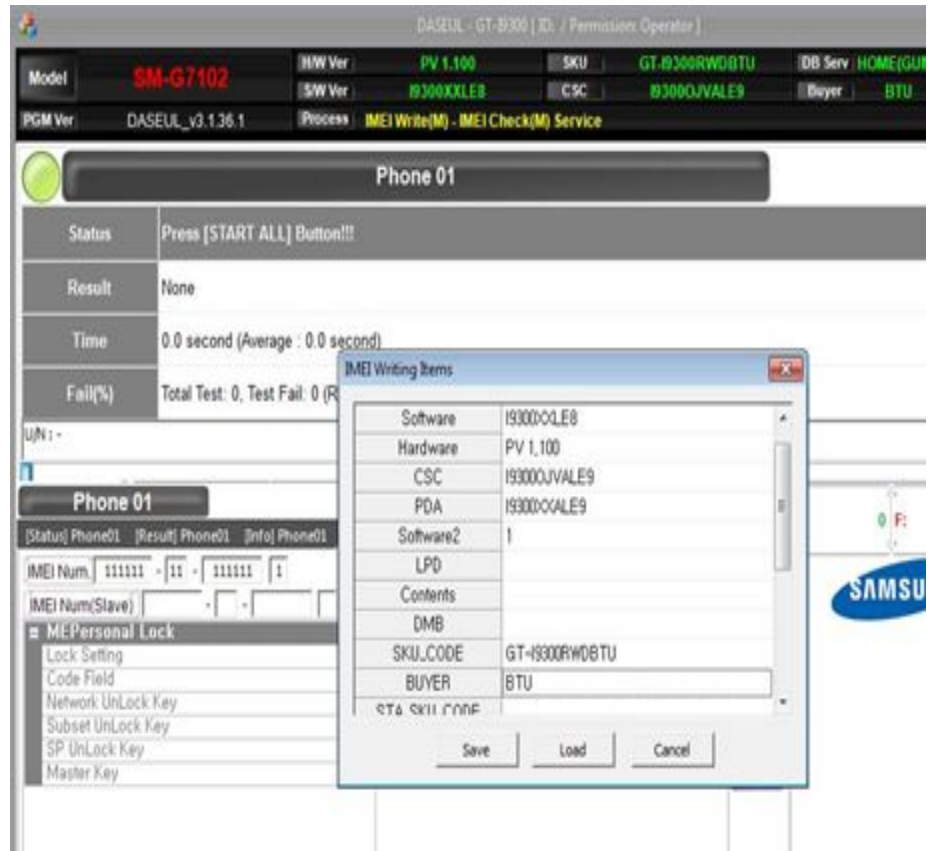
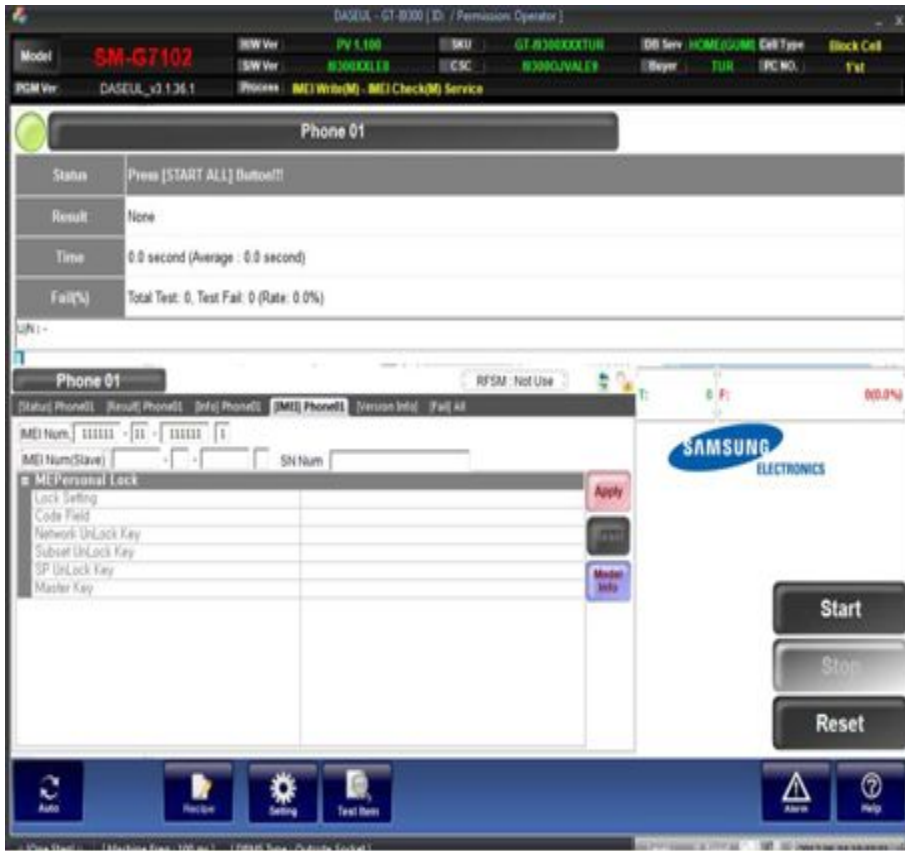

Emergency download mode & Odin T-Flash mode



Brief Process

- 1) Preparing SD card, using working GRAND2 3G (Samsung Method)
- 2) Inserting the SD Card to "eDL mode" phone for recovering.
- 3) Downloading the boot loader file to the defective phone, and Flash Full S/W (Pit, BL,AP, CP, CSC)

Pre-requisite

- 1) 1 Working GRAND2 3G phone (Consisting of T Flash Enabled Binary)
- 2) External SD card (Memory Size should be 8GB or bigger)
- 3) [SD card size should be more than the PIT file, Else the repartitioning of PIT file will fail]
- 4) Odin3 v3.07.exe and Odin3.ini
- 5) Latest PIT and Boot loader file

EDL mode verification

- Device not booting up
- Confirming a device is in Emergency Download mode (eDL mode).
 - 1) Attach the faulty device to Windows PC
 - 2) Go to Device Manager
 - 3) You should be able to see below item in Ports.



Boot Recovery (3/6)

- Insert External SD Card to normal phone to copy Boot loader to SD card
- Go to download mode (Vol Dn + Home Key + Power, Vol Up)
- Run Odin3 v3.07.exe with options enabled as shown
- Click on start button to download the binary into SD Card.

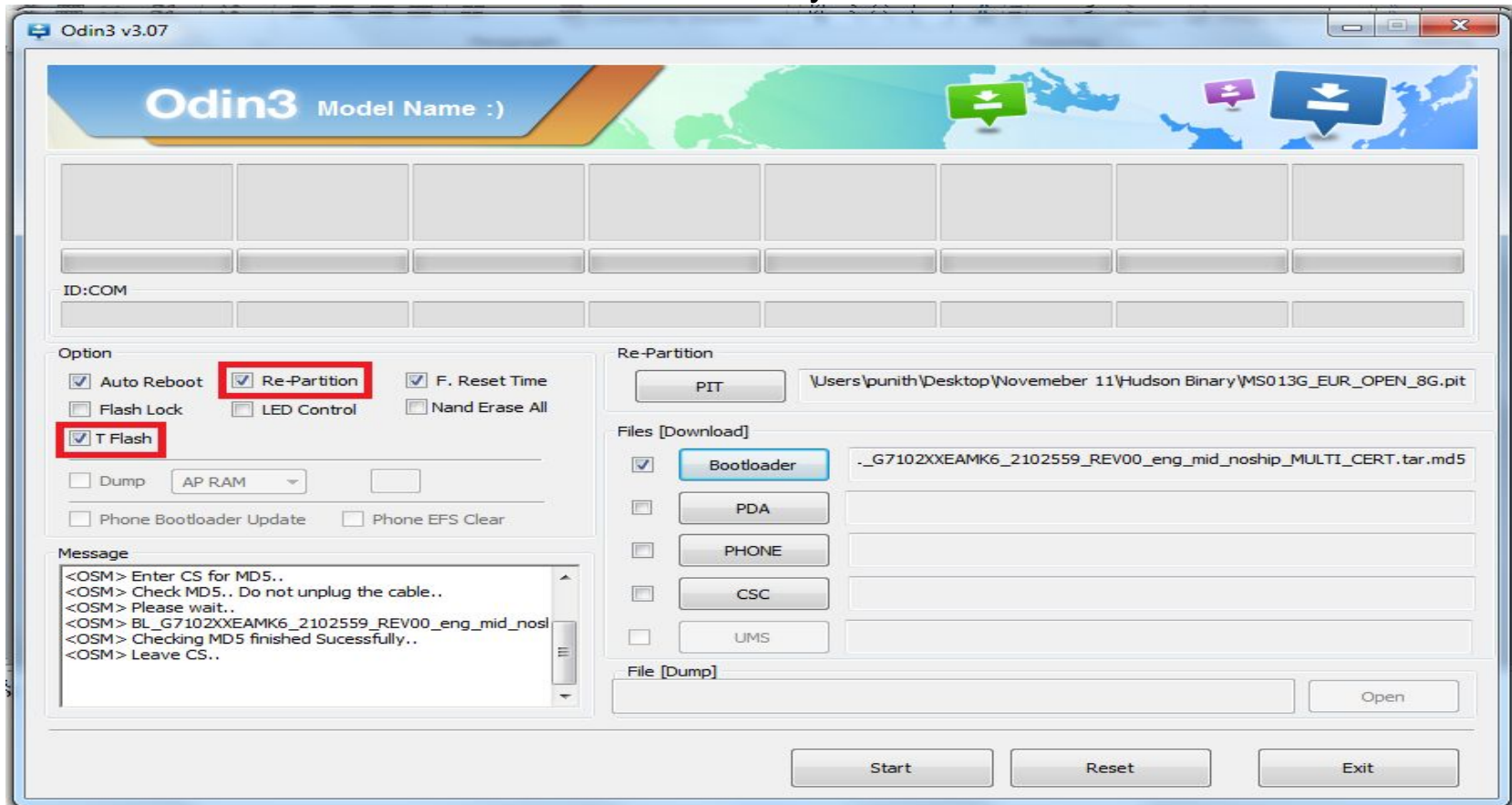

Boot Recovery (4/6)

- Use the SD card to recover a device going to eDL mode.
- Plug in the SD Card on to the device which is in eDL mode.
- Remove the Battery and put it back.
- make it to download mode with Volume Down + Power key and press Home key

※ Download Mode : Volume Down key + Home key + Power Key and press Volume Up key.

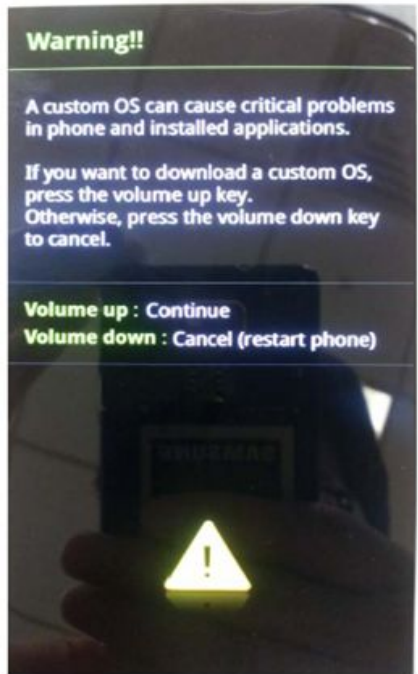

Volume Up
→

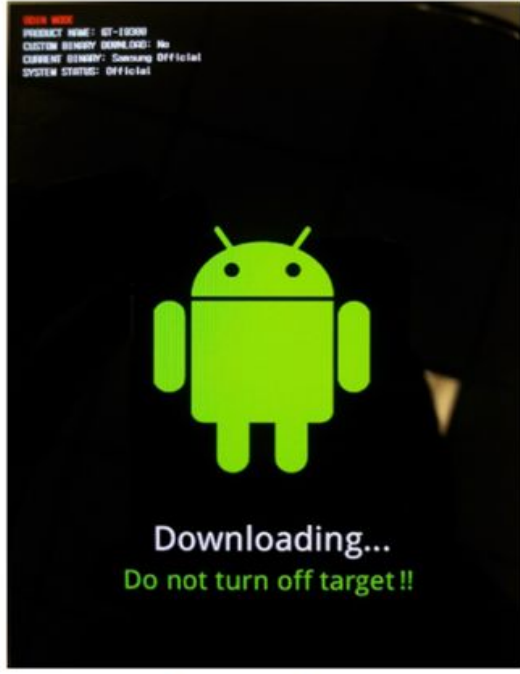

< Volume Down key + Home key + Power Key >

< Download Mode >

- Flash the Latest Pit and Boot loader on to the device (as shown below)

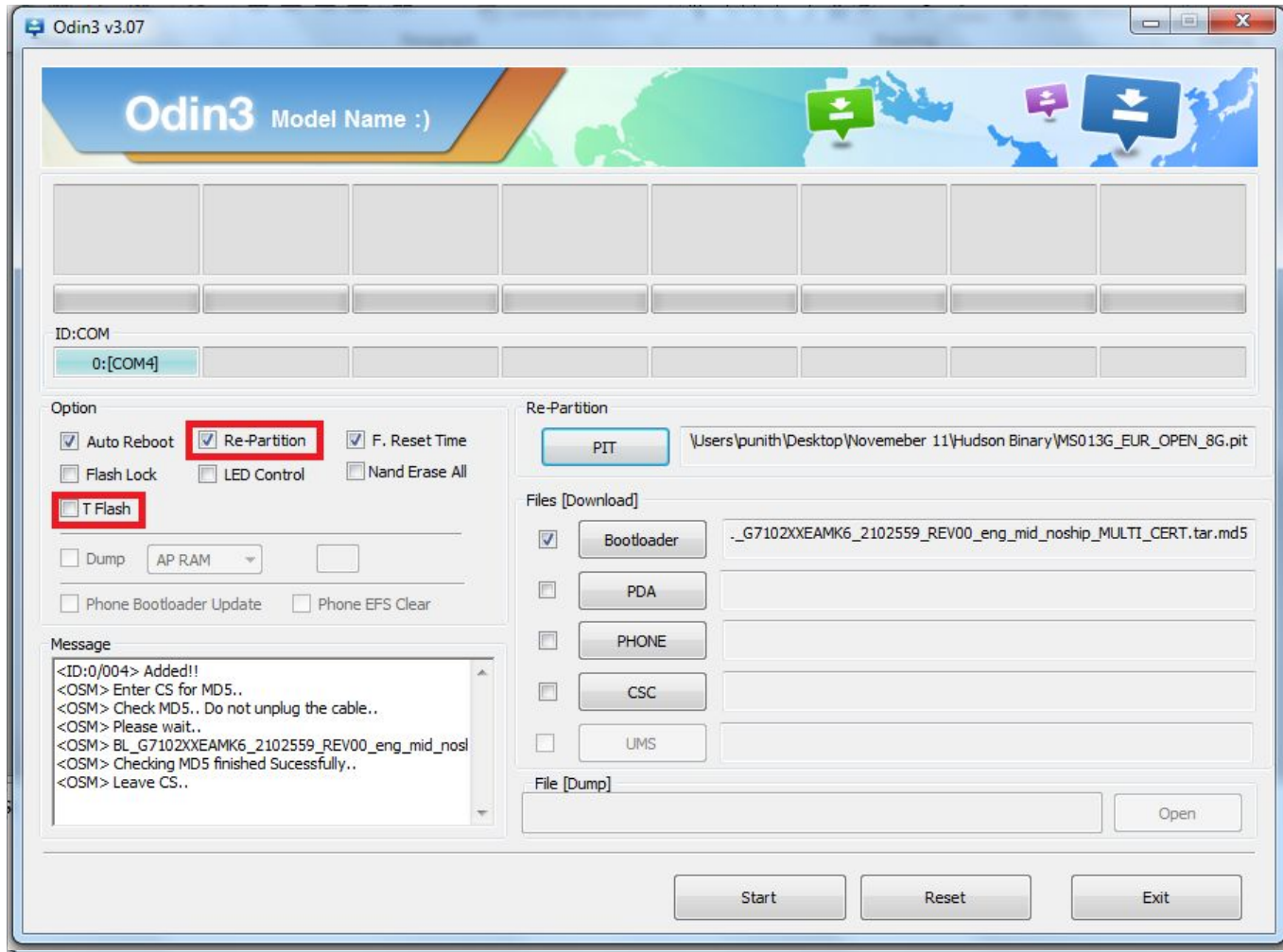

- Now remove the SD Card from Faulty device.
- Go to download mode (Vol Dn + Home + Power Key, Vol Up)
- Select all the binaries (Pit, BL, AP, CP, CSC) in Odin.
- Click on Start button to download

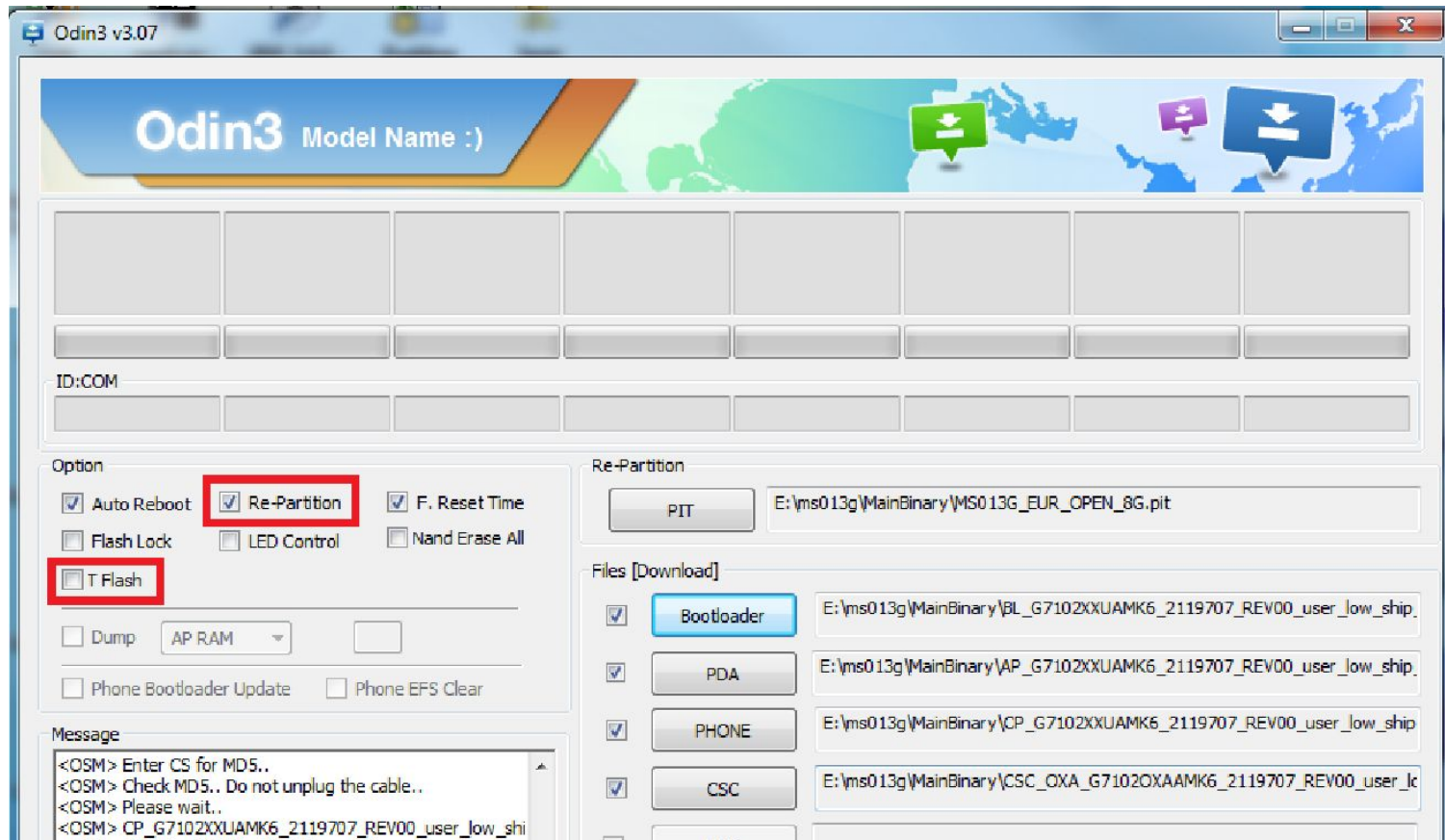

Disassembly & Assembly Instruction



Disassemble Instruction

1) Disassemble LCD connector protect cover.

※ Caution

1) Be careful of scratch and molding damage.

2) Separate the LCD connector.

※ Caution

1) Be careful of scratch and molding damage.

2) Be careful of damage to the FPCB.



Disassemble Instruction

- 3) Displace the temperature chamber for 10 minute
Detach the TSP/LCD Assay using Vaccum jig



AIR pressure
5~7 kgf/cm



※ Caution

- 1) Before disassembling, Use heating chamber.
- 2) Be careful of scratch and molding damage.

Disassemble Instruction

4) Unscrew the 10 points.



⚠ Caution

1) Be careful of scratch and molding damage.

Disassemble Instruction

5) Detach the PBA/Sheildcan Assay.

❌ Caution

- 1) Be careful of damage to the EARJACK Module.
- 2) Be careful of damage to the CAMERA.



Disassemble Instruction

6) Disassemble the RCV, Sensor, SPK from PBA.
Unscrew the 2 points.

❌ Caution

- 1) Be careful of damage to RCV.
- 2) It pushes this part at disassembly, and lift it



Disassemble Instruction

7) Separate the VGA, MEGA Camera from PBA Array.

✘ Caution

1) Be careful of damage to the TSP FPCB.

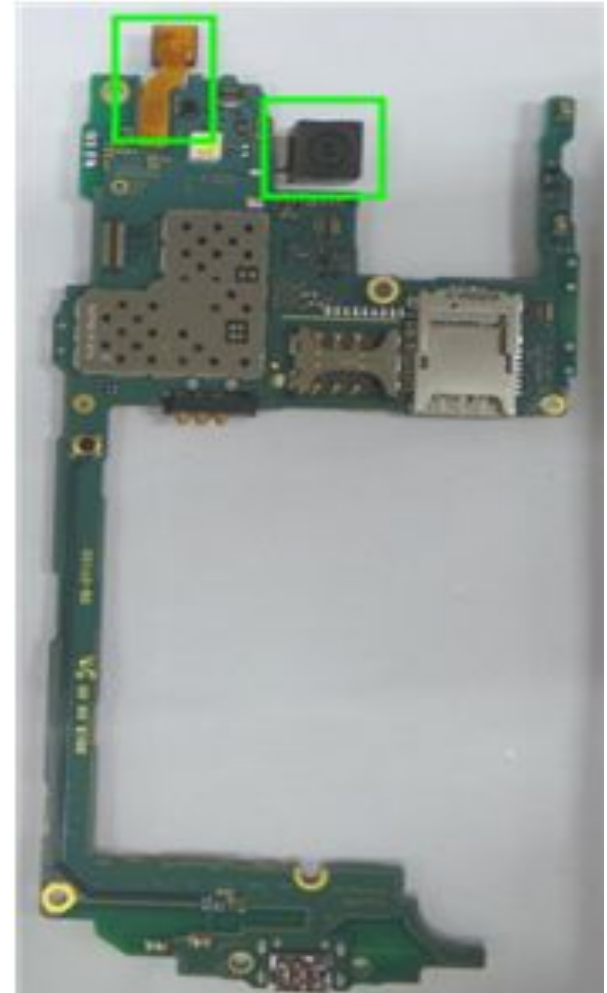

Disassemble Instruction

8) Separate the Top dummy, Bottom dummy & Speaker from hook.

❌ Caution

- 1) Be careful of scratch and molding damage.
- 2) Be careful of damage to the TSP & LCD.



Assemble Instruction

1) Assemble the Top dummy, Speaker on shield can.

❌ Caution

1) Be careful of damage to the part.



Assemble Instruction

2) Assemble the PBA on Shieldcan.
Screw the 2 points..

❌ Caution

1) Be careful of damage to the part.



Assemble Instruction

- 3) Assemble PBA assy to the Rear
Assemble Bottom dummy on the Rear

❌ Caution

- 1) Be careful of damage to PBA



Assemble Instruction

- 4) Remove the TSP tape
(in case of replacing the new TSP module)

❌ Caution

- 1) Be careful of damage to each module.
- 5) Attach the TSP tape
(in case of replacing the new TSP module)



Assemble Instruction

- 6) Screw the 10 points of the Rear.
 $1.2 \pm 0.1 \text{ Kgf/cm}^2$.

⚠ Caution

- 1) Be careful of scratch and molding damage.



Assemble Instruction

- 7) Attach the LCD assy to the Rear Assy.
- 8) Assemble LCD connector.

❌ Caution

- 1) Be careful of scratch and molding damage.



Assemble Instruction

9) Assemble LCD connector protect cover.

✘ Caution

1) Be careful of scratch and molding damage.



Assemble Instruction

10) Press the set using pressure jig.

❌ Caution

- 1) - Pressure : 5~6 kgf/cm²
- Press time : 9.7 sec .



Electronic Components



Electronic Components (1/2)

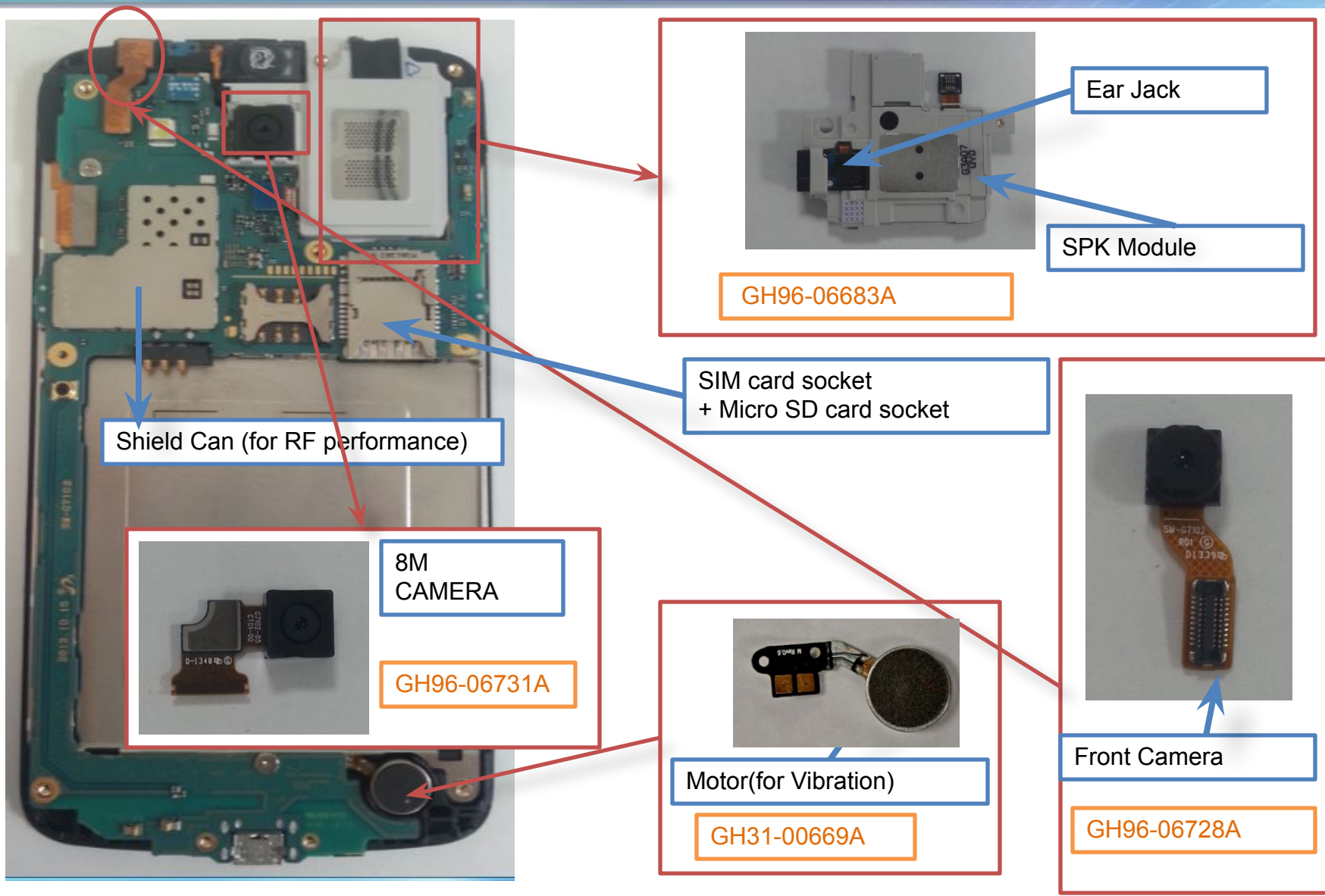

Electronic Components (2/2)

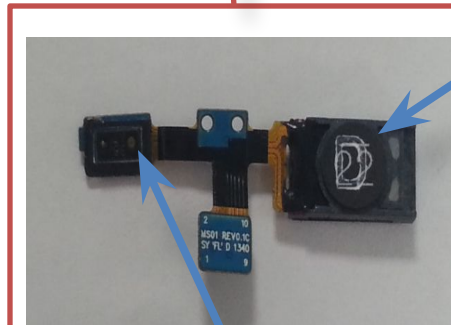
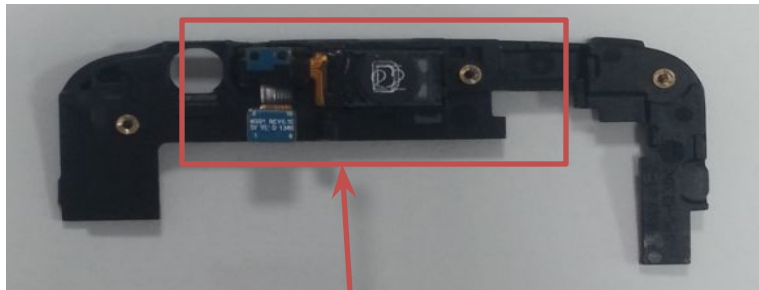

Receiver

Proximity Sensor

GH59-013770A



SMD parts (TOP side)

U502	1205-004833	AUDIO CODEC
TAC500,501,502	3404-001487	Tact key
U201	1205-004825	BT/WIFI/FM Module
OSC200	2801-005323	Oscillator - 48Mhz
U205	1209-002151	Accelerometer Sensor
U202	1009-001058	HALL IC
OSC400	2801-005300	Oscillator - 19.2Mhz
U401	1203-008057	PMIC
ANT500, ANT501	3712-001490	Motor contact
ANT502, ANT503	3712-001490	Home key contact
IFC400	3722-003708	Interface Connector(Micro USB)

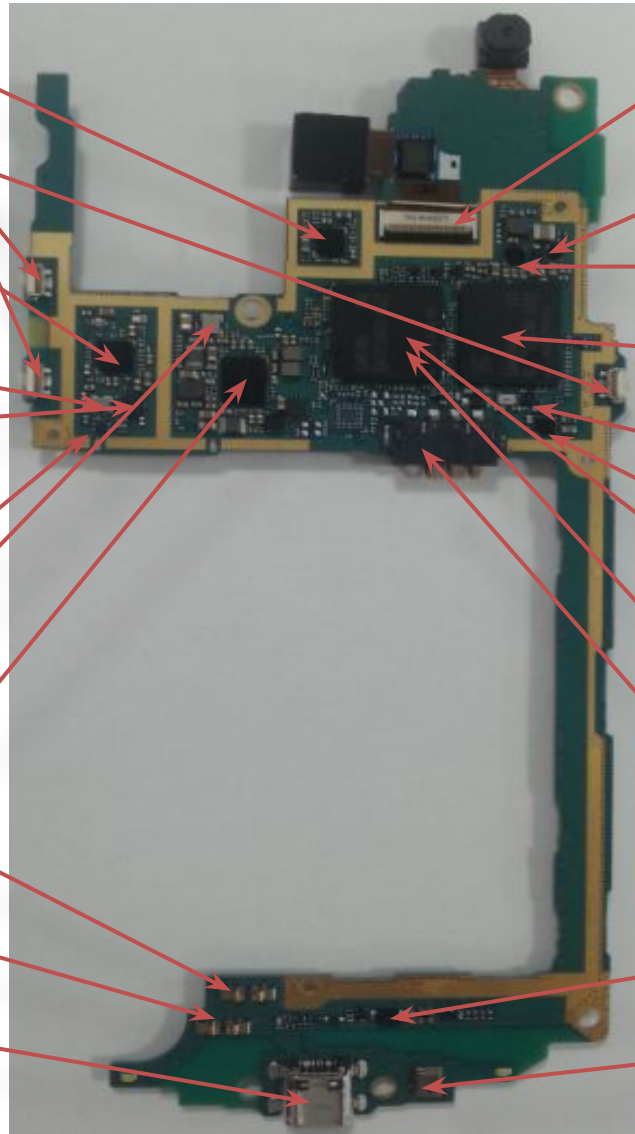

HDC602	3708-003167	Connector(8M CAM)
U608	1203-008056	Backlight Driver IC
U601	1203-007869	Panel power supplier
UME300	1107-002283	eMMC
U402	1205-004513	Load Switch
U404	1001-001822	uUSB Switch IC
UCP300	1205-004931	AP
UCP300UP	1105-002540	LPDDR2(POP)
BTC400	3711-008587	Battery Contact
U602	1203-004776	Motor LDO
MIC500	3003-001188	Mems mic.

SMD parts (Bottom side)

HDC601 3711-007467
Connector(1.9M CAM)

HDC600 3711-007883
LCD Connector

U102 1205-004829
2G/3G Transceiver

U101 1201-003701
Band1/Band 8 PA

U106 1201-003699
2G PA/TX Module

U101 1201-003702
Band2/Band 5 PA

RFS100 3705-001731
RF Switch

ANT101 3712-001490
Main ANT connector

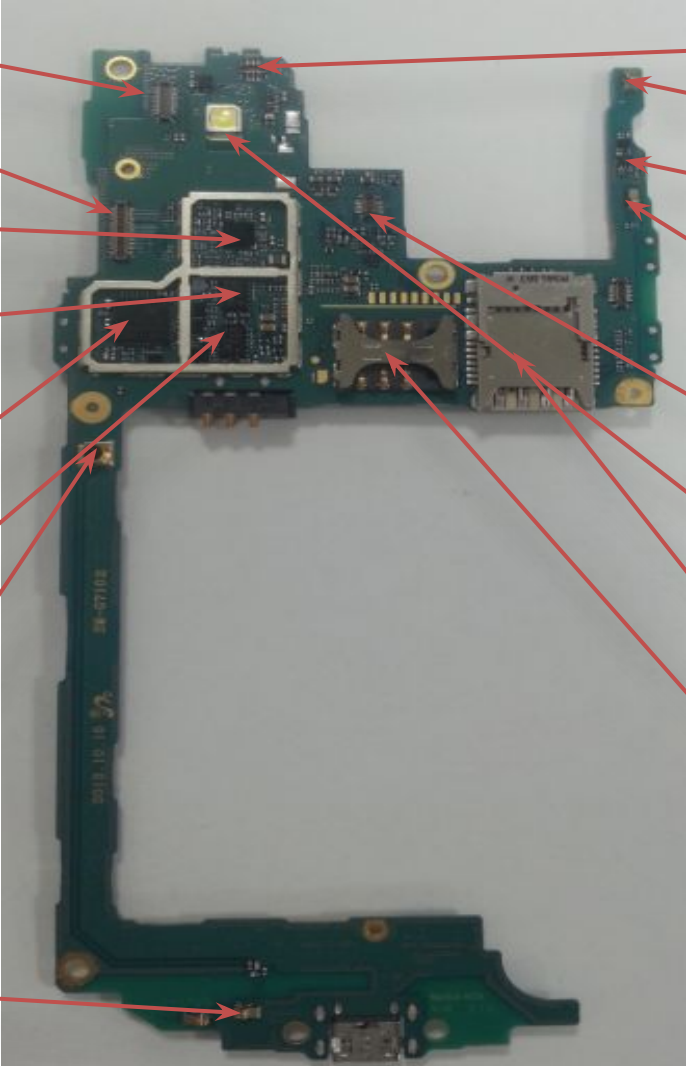

HDC500 3711-007478
Receiver/Proxy sensor connector

Ant200 3712-001490
Ant. Contact (for GPS)

U200 1201-003631
GPS LNA(Low Noise Amp.)

Ant200 3712-001473
Ant. Contact (for BT/WIFI)

HDC501 3711-007478
SPK & Earjack connector

LED600 0601-003364
Flash LED

SIM601 3709-001829
Sim1+Micro SDcard socket

SIM600 3709-001799
Sim2 card socket

Troubleshooting



Power problem

Step	Check point	Result value	Defect point
1	Confirm the defect symptom	-	-
2	Check the power with a new battery	Solved	Battery
		Not solved	Go to the next step
3	Check the PBA current with a power supply (power supply voltage : 3.8 ~ 4.0V)	High current (over than 1A)	Circuit short
		Low current	S/W download
		Normal current	Display or Power key
		No current (almost 0mA)	Go to the next step
4	Check the V_{batt} (+point) of battery contact	C425 = 3.8V (same as power supply voltage)	Go to the next step
		If not the correct value	PMIC (U401)
5	Check the voltage of following chips (C561,C558,C556,C559,TP(AP_PS_HOLD))	C484,C485 = 1.15V C466 = 1.3V C467 = 2.1V R420 (MSM_PS_HOLD) > 1.8V	Go to the next step
		If not the correct value	PMIC (U401)
6	Check the frequency of OSC400	19.2MHz	Main chip (UCP300)
		If not the correct value	X-tal (OSC400)

Power problem

Step 4,5,6

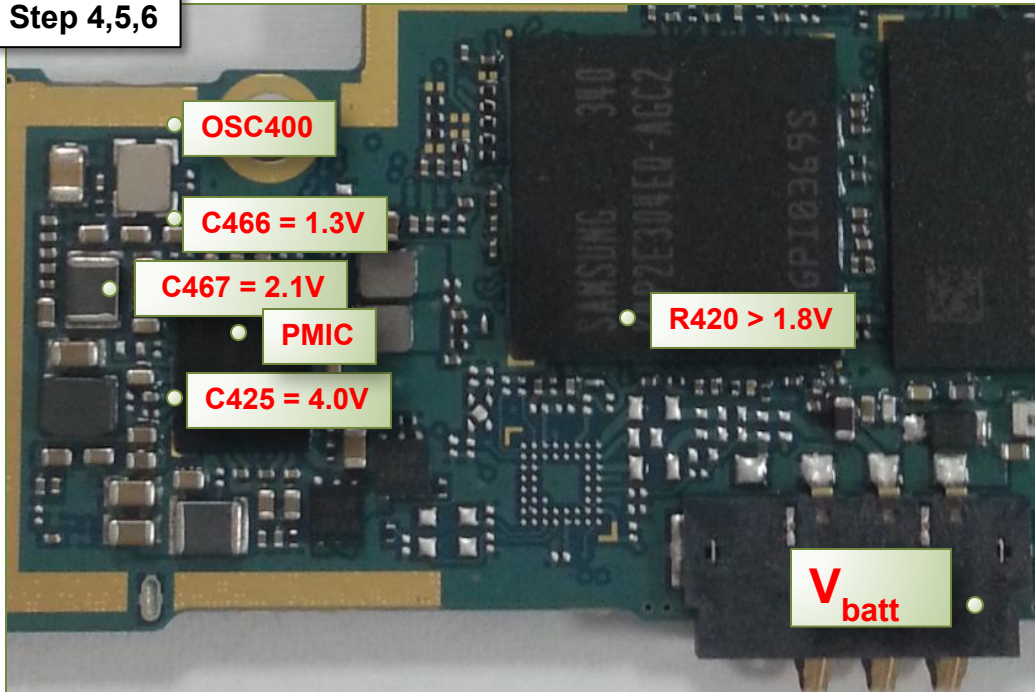

Step5

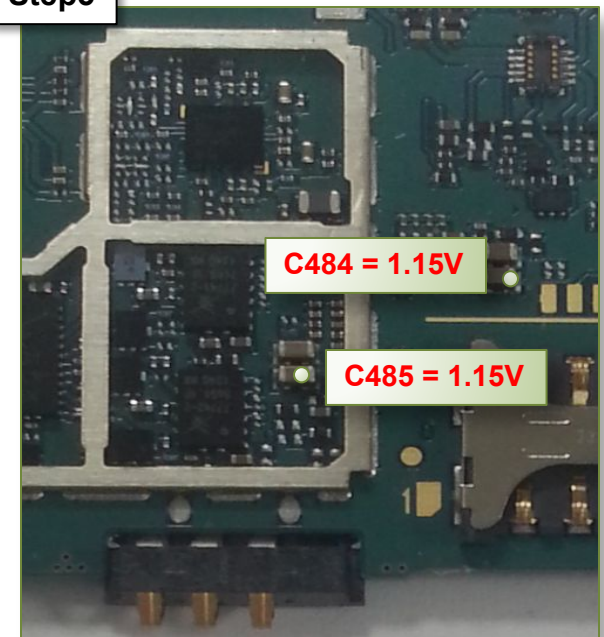

Step	Check point	Result value	Defect point
1	Confirm the defect symptom (Make a call, check the debug screen *#0011#)	-	-
2	Check the settings (airplane mode, Mobile networks)	Abnormal	Settings
		Normal	Go to the next step
3	Check the status main ANT	Broken, dust, corrosion No insert	Main ant
		Normal	Go to the next step
4	Power on with a power supply (power supply voltage : 3.8V)	-	-
5	Check the status(crack, missing, Corrosion..etc) of RF components. ANT101 (ANT contact) U106 (Tx module, PAM) U101 (B1,B8 PAM) F102,F104 (B1,B8 DUF) U104 (B2,B5 PAM) U610,F105 (B2,B5 DUF) F101(Saw Filter) U102 (Transceiver)	Abnormal status (compared with a good PBA)	RF components.
		Normal status (compared with a good PBA)	CP(Call Processor) (UCP300)

Step2

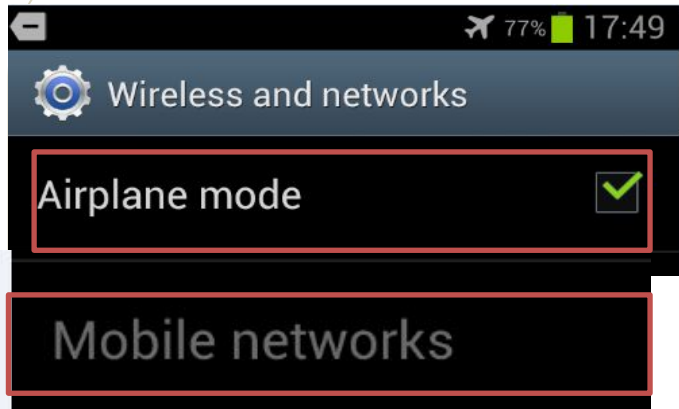

CHECK SETTINGS

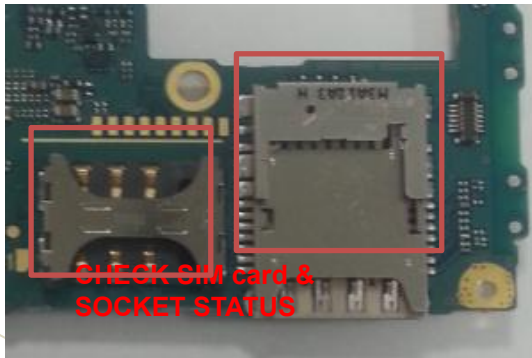

CHECK SIM card & SOCKET STATUS

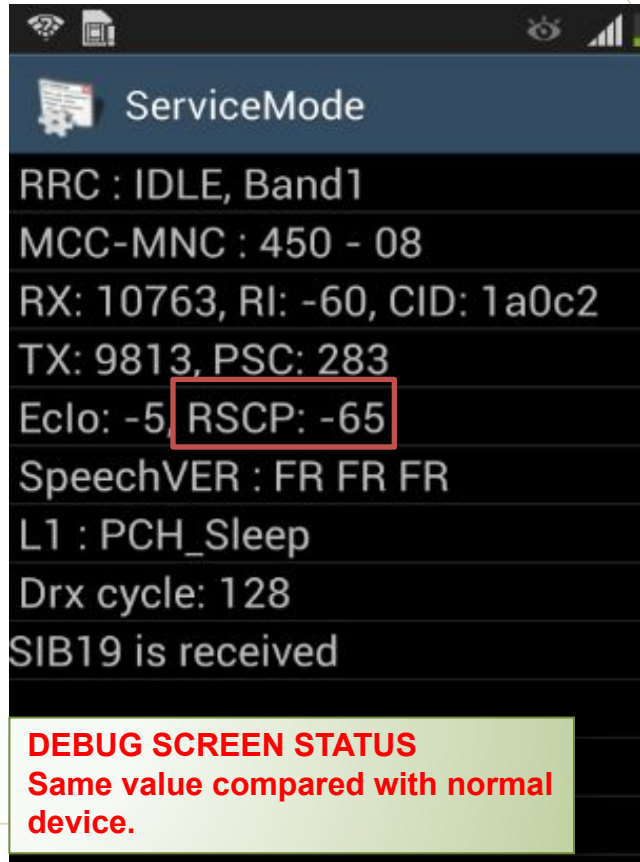

DEBUG SCREEN STATUS
Same value compared with normal device.

Step3

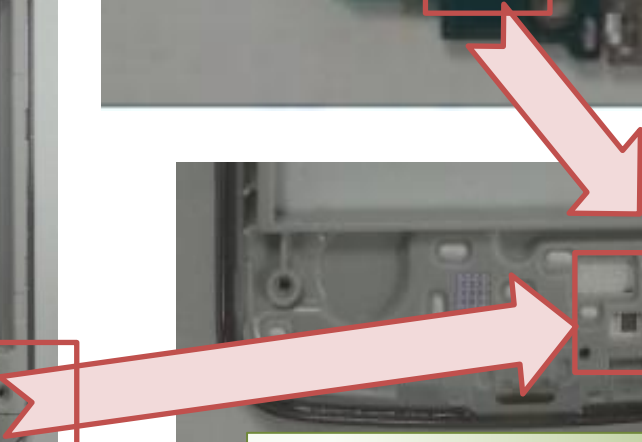
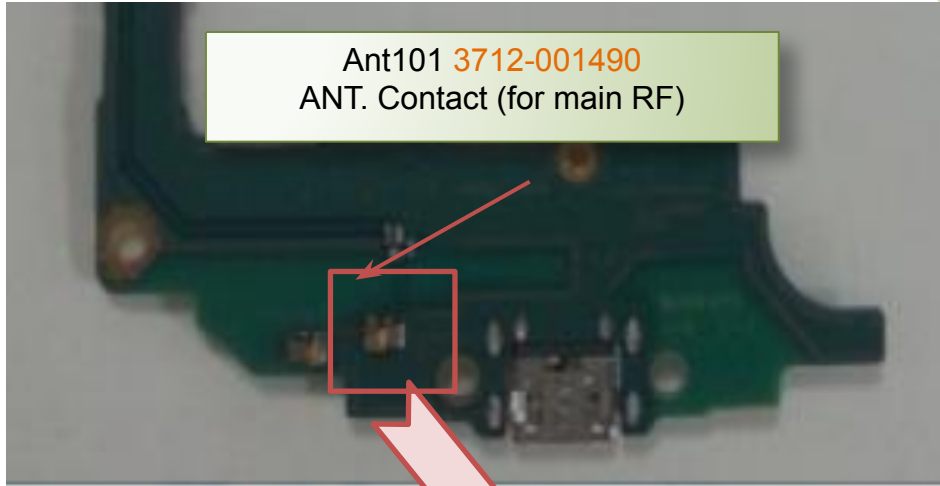

Step5

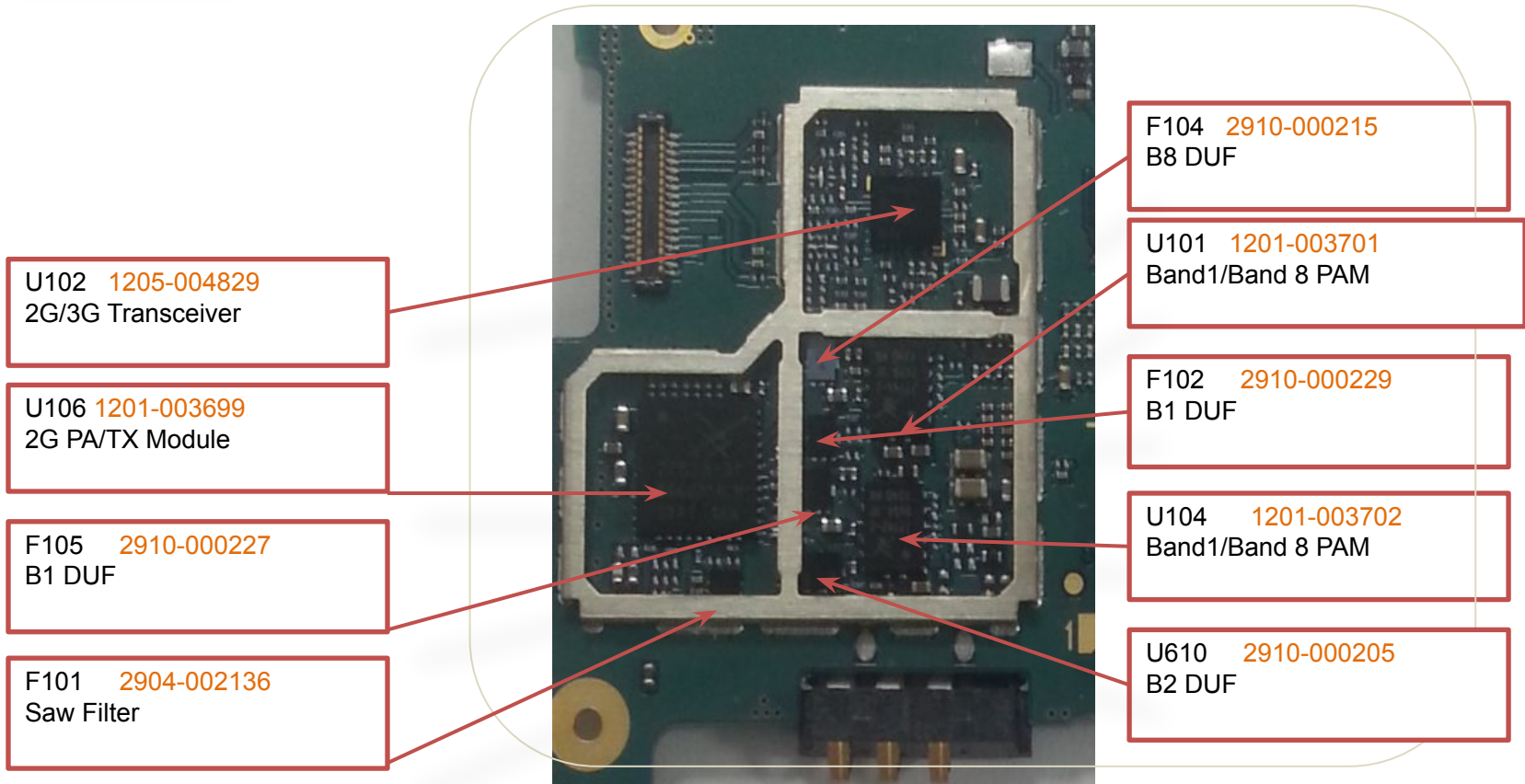

Step	Check point	Result value	Defect point
1	Confirm the defect symptom (Check the turned on BT/WIFI & connected device)	Turned on	Go to the next step
		Turned off	Turn on
2	Check the BT/WIFI Ant. & Ant contact. (Rear cover Ant. & ANT201)	Broken, dust, corrosion	Ant & ANT201
		Normal	Go to the next step
3	Power on with a power supply (power supply voltage : 3.8V)	-	-
4	Check the voltage of C201,C200,C222 Notice. It should be measured when the BT/WIFI path is activated on	C201 = 1.3V C200 = 3.0V C222 = 1.8V	Go to the next step
		If not the correct value	PMIC (U401)
5	Check the clock of C203 Notice. It should be measured when the BT/WIFI is activated on	C203 = 48MHz (Same signal compared with a good PBA)	Go to the next step
		If not the correct value	OSC200
6	Check the status(crack, missing, Corrosion..etc) of RF components. C238, L212, ,C237 (ANT Matching) F201,F200,C228 (filter and filter matching) Notice. It should be measured when the BT/WIFI path is activated on	Abnormal status (compared with a good PBA)	RF components.
		If not the correct value	BT/WIFI IC (U201)

Step1



Step

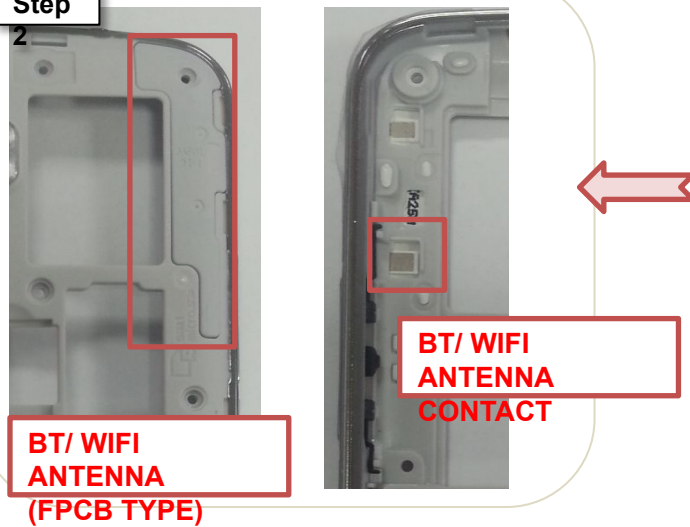

Step4,5

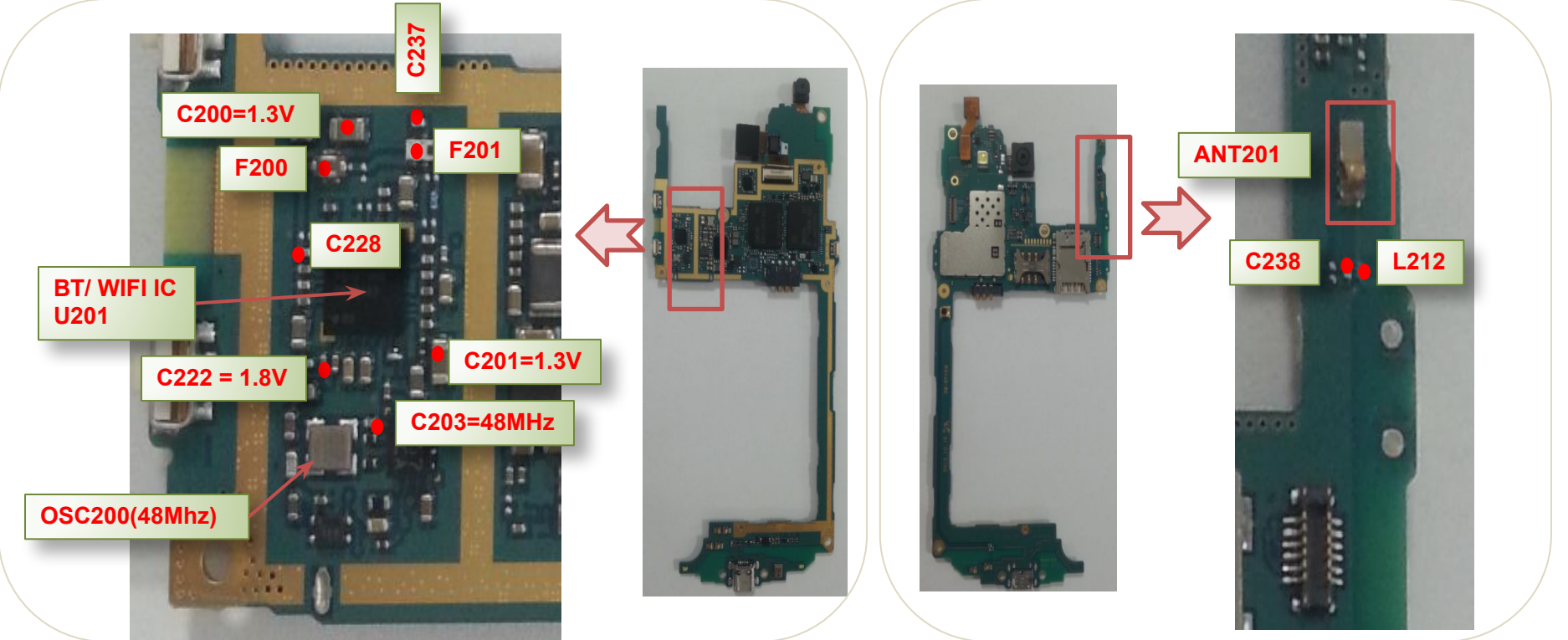

Step	Check point	Result value	Defect point
1	Confirm the defect symptom (Check the turned on GPS function)	Turned on	Go to the next step
		Turned off	Turn on
2	Check the status Antenna and GPS components. - ANT200, C226, C233, L209, F202, C234, L205	Broken, dust, corrosion	ANT200 GPS component
		Normal	Go to the next step
3	Power on with a power supply (power supply voltage : 3.8V)	-	-
4	Check the voltage of C245 Notice. It should be measured when the GPS path is activated on	C245 = 2.75V	Go to the next step
		If not the correct value	PMIC(U401)
5	Check the voltage of C241 Notice. It should be measured when the GPS path is activated on	C241 = 1.8V	Go to the next step
		If not the correct value	AP(UCP300)
6	Check the clock of C156 Notice. It should be measured when the GPS path is activated on	C156 = 19.2Mhz (Same signal compared with a good PBA)	GPS IC(U102) GPS LNA(U200)
		If not the correct value	OSC200

Step1

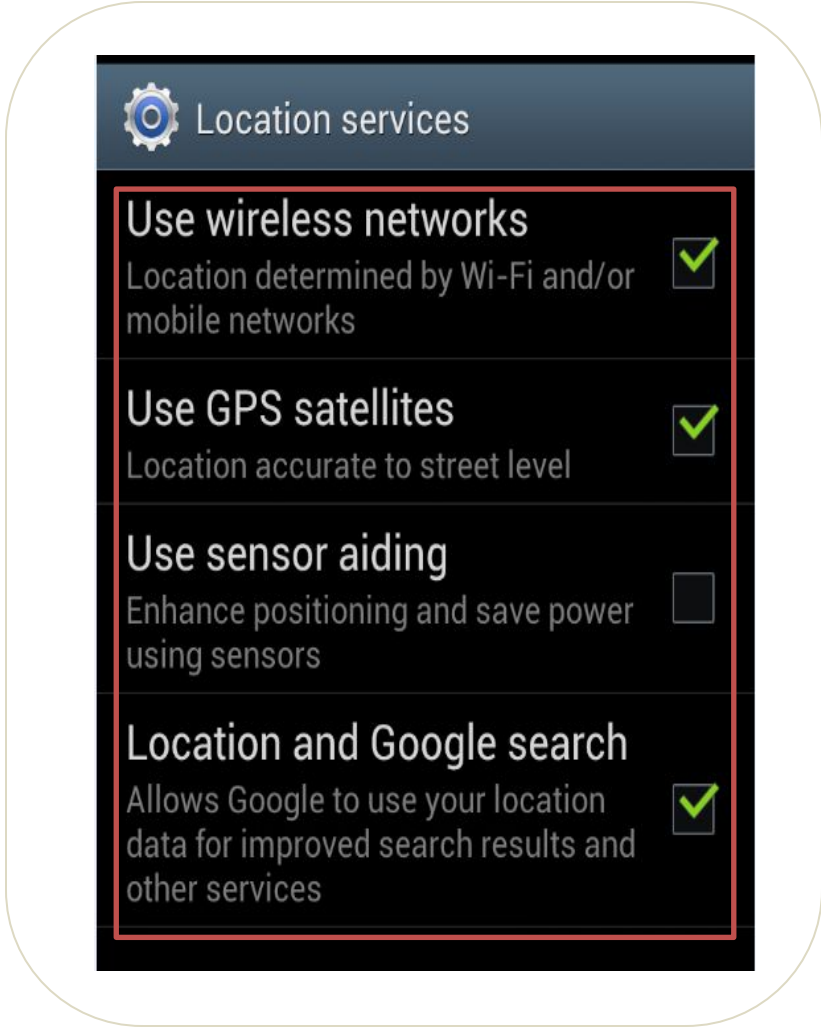

Step2

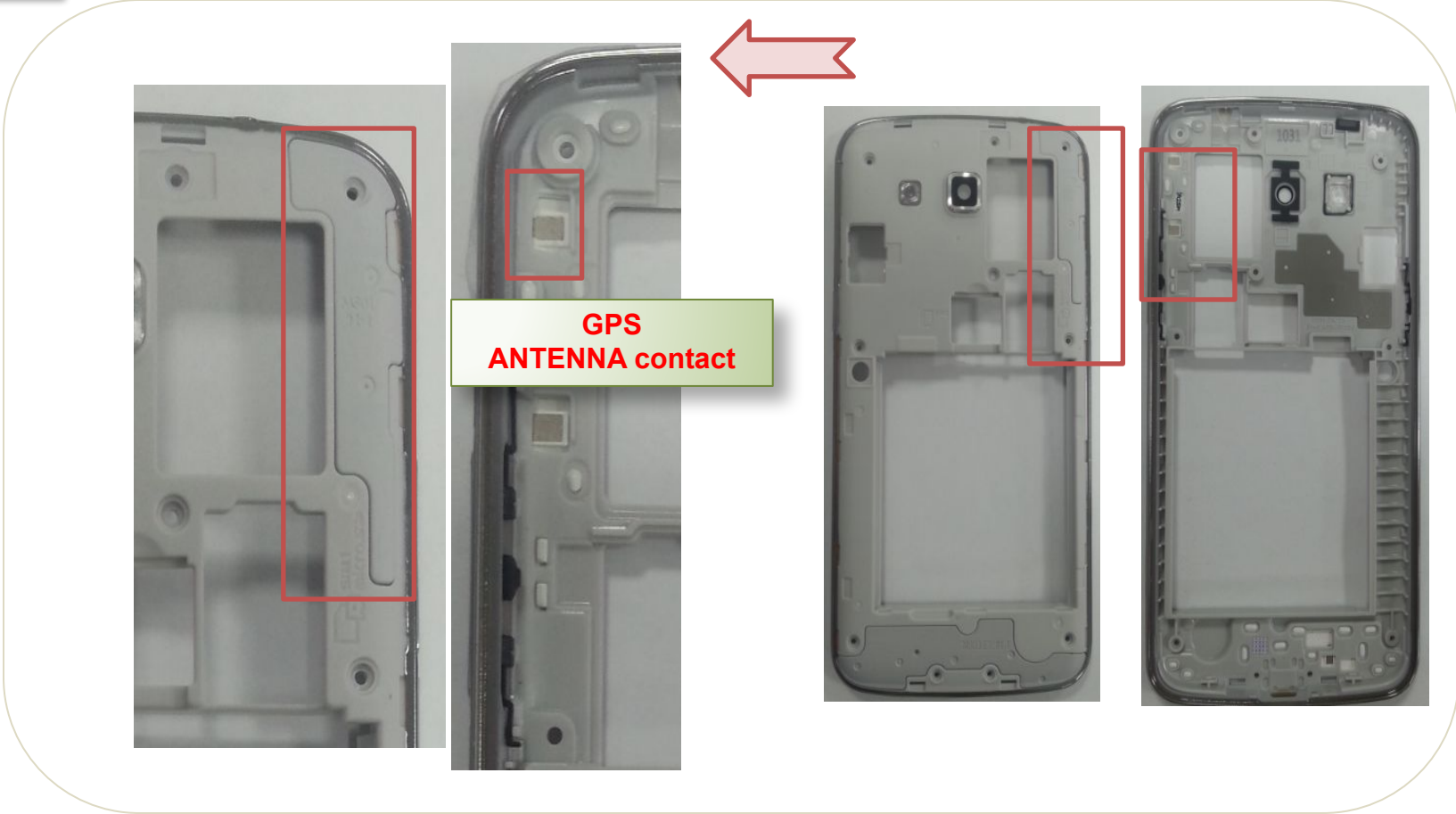

Step4,5

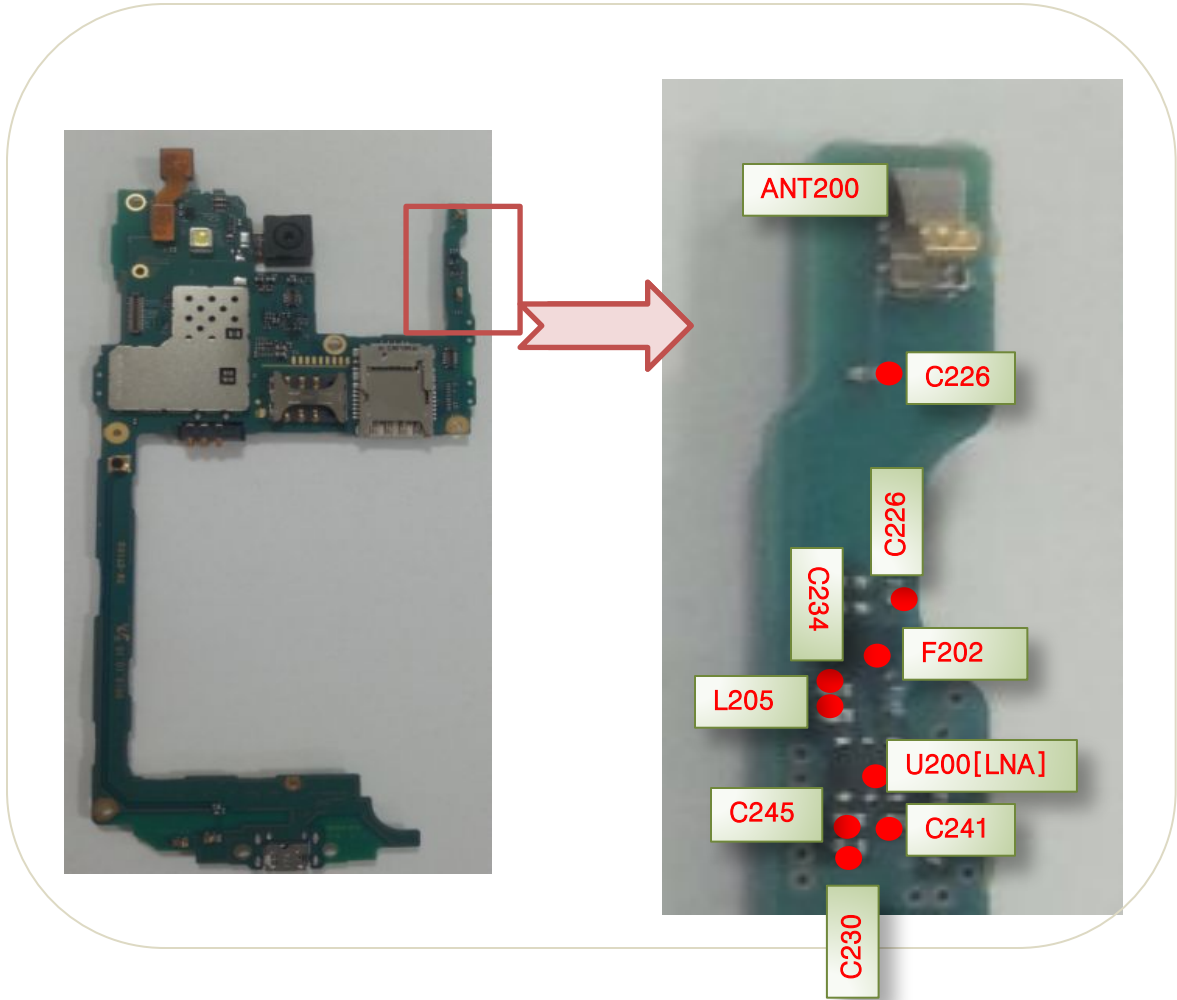

Step4,5,6

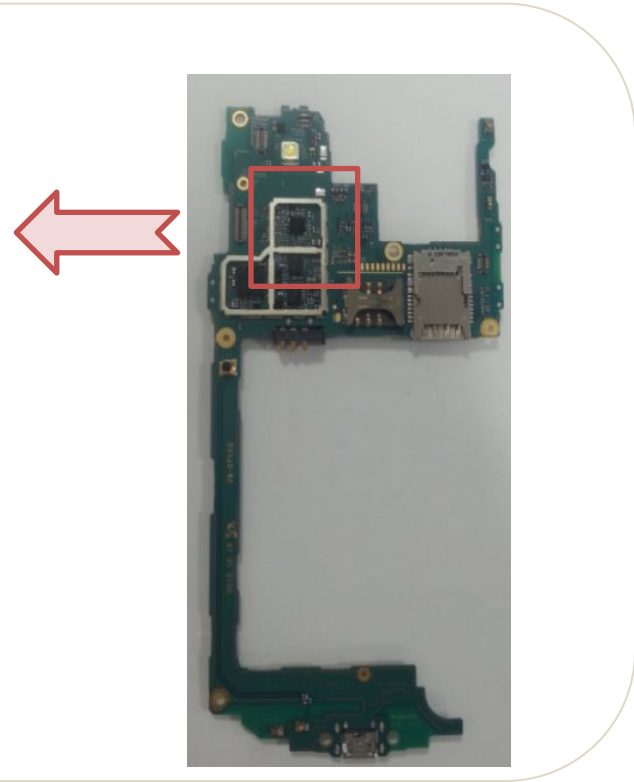
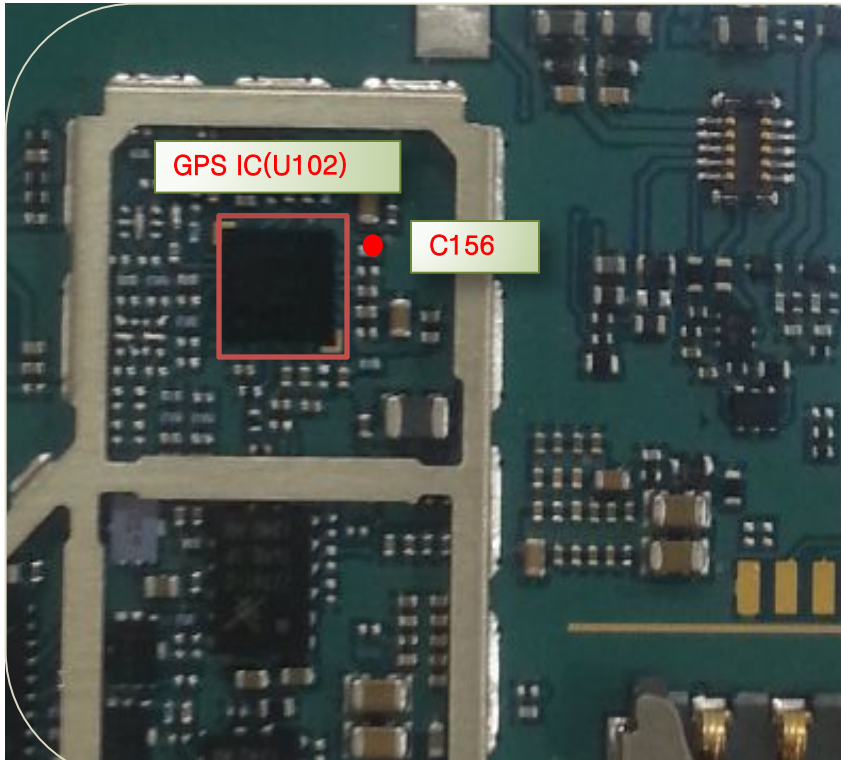

Speaker problem

Step	Check point	Result value	Defect point
1	Confirm the defect symptom	-	-
2	Make a factory reset (*2767*3855#)	Solved	Setting error
		Not solved	Go to the next step
3	Check the speaker connector (HDC501)	Broken, dust, corrosion	Speaker connector
		Normal	Go to the next step
4	Replace the speaker module (GH96-06683A)	Solved	speaker
		Not solved	Go to the next step
5	Connect a LCD, and power on with a power supply (power supply voltage : 3.8V)	-	-
6	Activate the speaker path (*#0*# → Speaker)	-	-
7	Check the signal of speaker contact (C529,C530)	Same signal compared with a good PBA	PBA
	Notice. It should be measured when the speaker path is activated on	No signal	Audio Codec (U502)

Step3 Step4

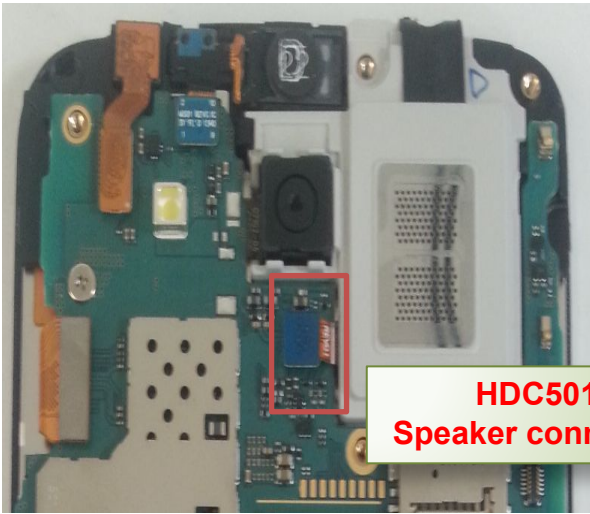

**HDC501
Speaker connector**

Ear Jack

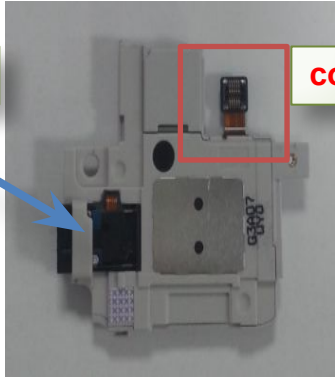

connector

SPK Module

GH96-06683A

Speaker problem

Step7

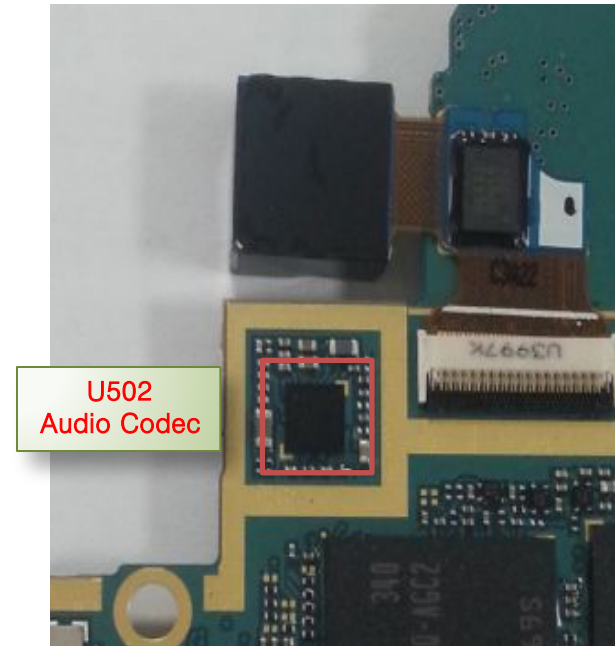
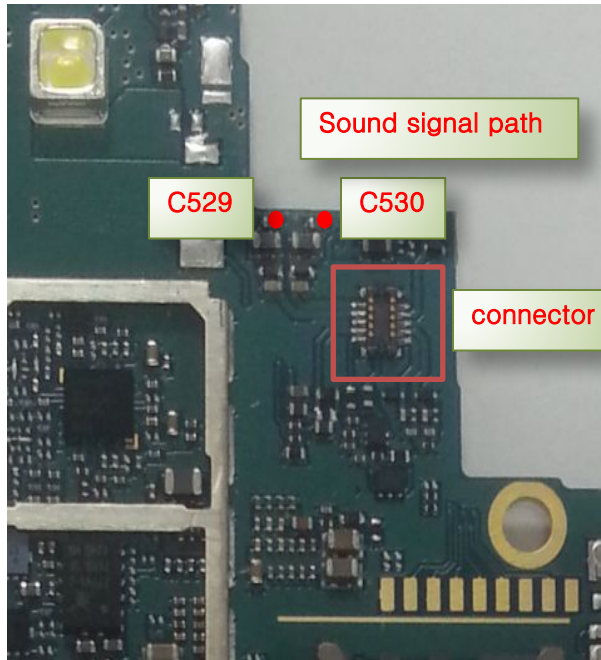

Step	Check point	Result value	Defect point
1	Confirm the defect symptom	-	-
2	Check the LCD connector	Broken, dust, corrosion Insert status	LCD connector (HDC600)
		Normal	Go to the next step
3	Replace the LCD	Solved	LCD
		Not solved	Go to the next step
4	Connect a LCD and display on with a power supply (power supply voltage : 3.8V)	-	-
5	Check the voltage of C606 = 1.8V Notice. It should be measured when the display is activated on	If not the correct value	PMIC(U401)
		C606=1.8V	Go to the next step
6	Check the voltage of C602 > 18V Notice. It should be measured when the display is activated on	If not the correct value	Back light IC(U608)
		C602>18V	Go to the next step
7	Check the voltage of following chips (C607,C605) Notice. It should be measured when the display is activated on	If not the correct value	U601(panel power supplier)
		C607 = 5V C605 = -1.5 ~ -5V	MAIN CHIP

Display problem

Step2,3,5,

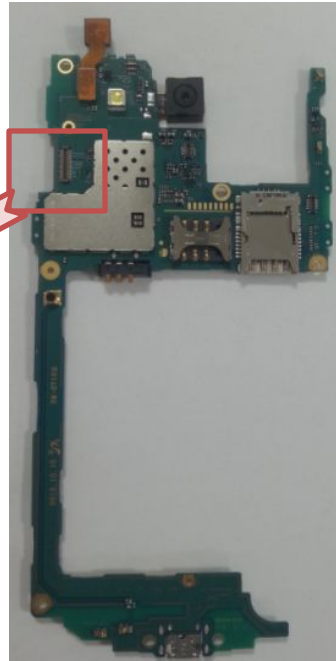
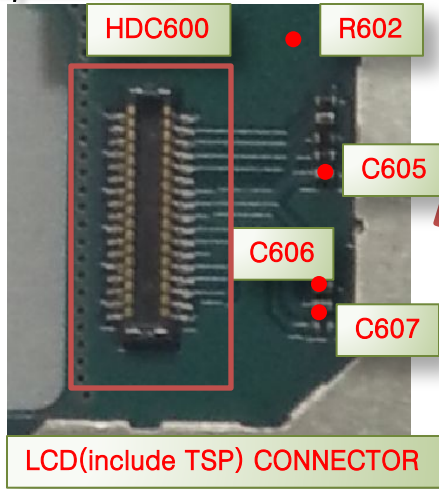

Step6

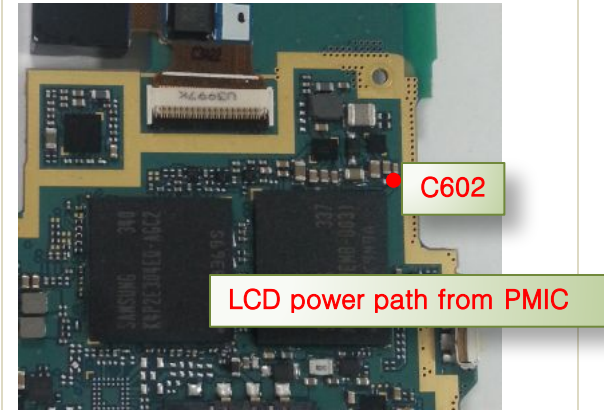

Step6

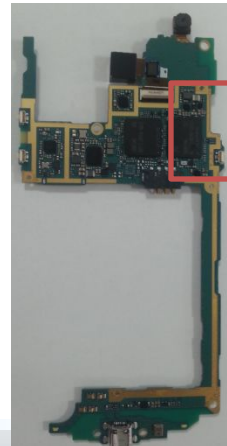

Step	Check point	Result value	Defect point
1	Confirm the defect symptom	-	-
2	Check the LCD connector (HDC600)	Broken, dust, corrosion	LCD connector (HDC600)
		Normal	Go to the next step
3	Check the TSP connector on LCD module.	Broken, dust, corrosion	TSP connector
		Normal	Go to the next step
4	Replace the TSP	Solved	TSP
		Not solved	Go to the next step
5	Connect a LCD and display on with a power supply (power supply voltage : 3.8V)	-	-
6	Check the voltage of following chips (C604,C433) Notice. It should be measured when the display is activated on	If not the correct value	C604-> LDO(U605) C433 -> PMIC(U401)
		C604 = 2.8V C433 = 1.8V	Go to the next step
7	Check the Signal of following chips (R601,R602) Notice. It should be measured when the display is activated on	If not the correct value	R601,R602
		Same signal compared with a good PBA	MAIN CHIP or PBA

Touch problem

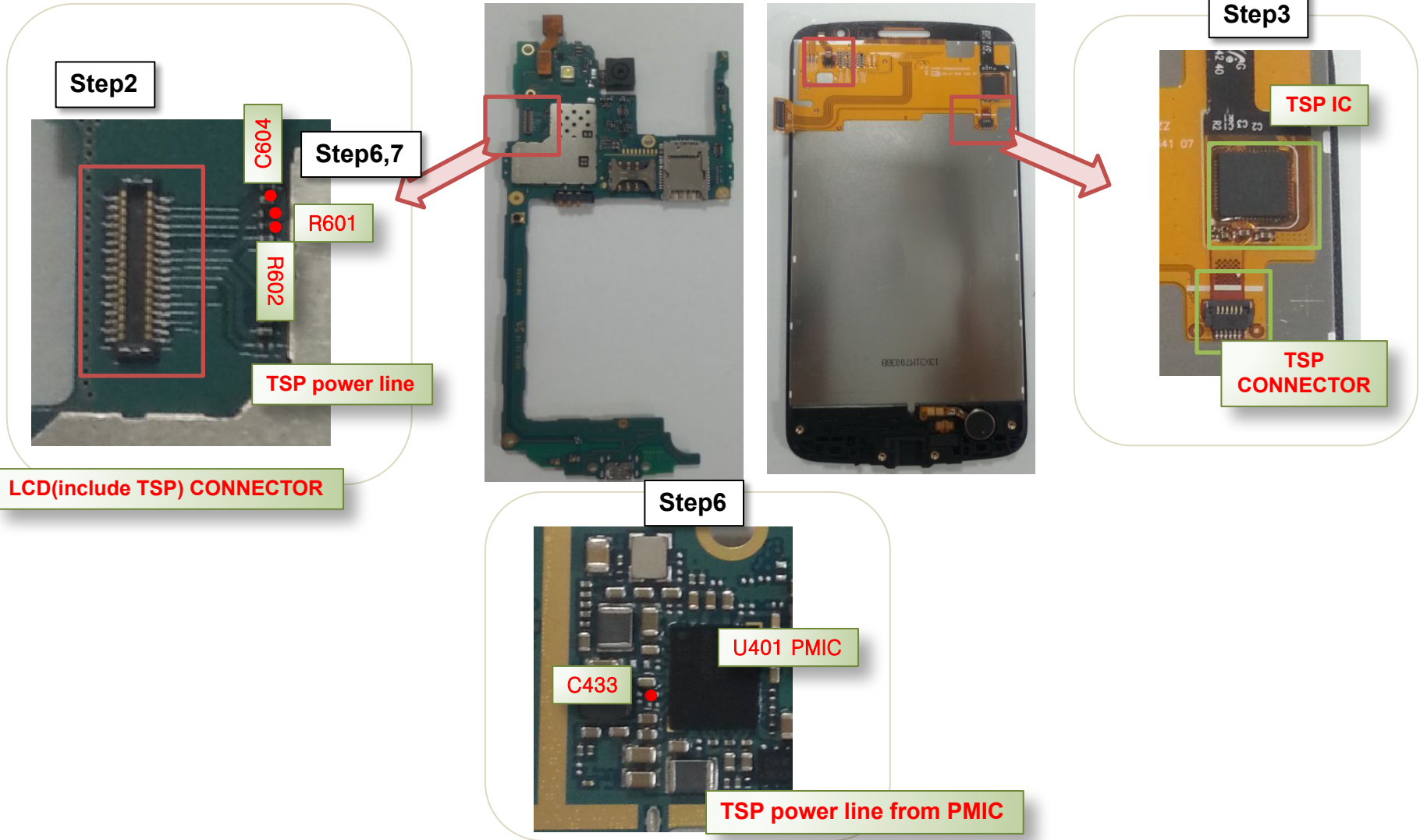

Receiver problem

Step	Check point	Result value	Defect point
1	Confirm the defect symptom (*#0*# → Receiver)	-	-
2	Make a factory reset (*2767*3855#)	Solved	Setting error
		Not solved	Go to the next step
3	Check the receiver connector(HDC601)	Broken, dust, corrosion	connector
		Normal	Go to the next step
4	Replace the receiver module (GH59-13770A)	Solved	Receiver
		Not solved	Go to the next step
5	Connect a LCD, and power on with a power supply (power supply voltage : 3.8V)	-	-
6	Activate the speaker path (*#0*# → Receiver)	-	-
7	Check the signal of C524,C525 Notice. It should be measured when the Receiver path is activated on	Same signal compared with a good PBA	CP (UCP300)
		No signal	Audio codec (U502)

Receiver problem

Step3

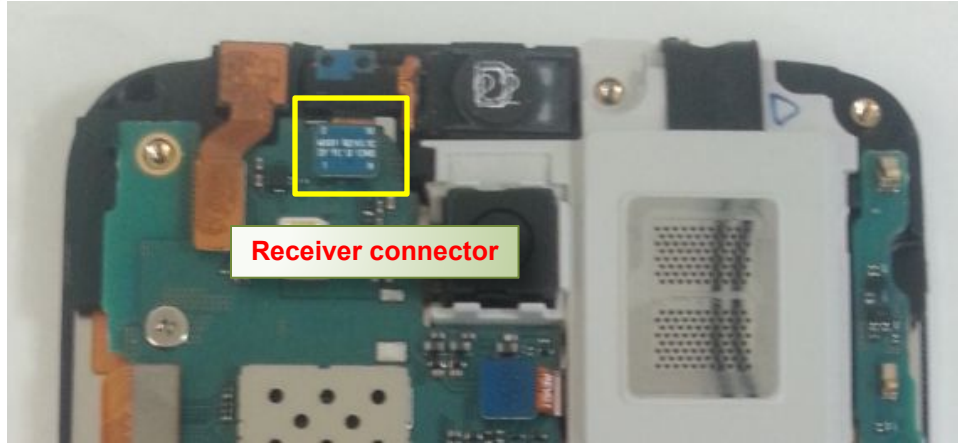

Step7



Step4

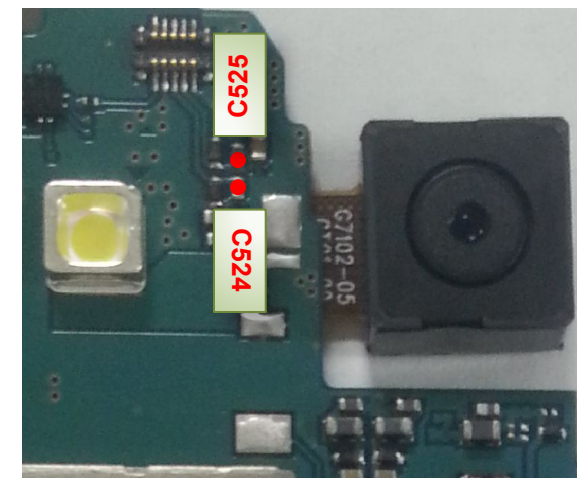
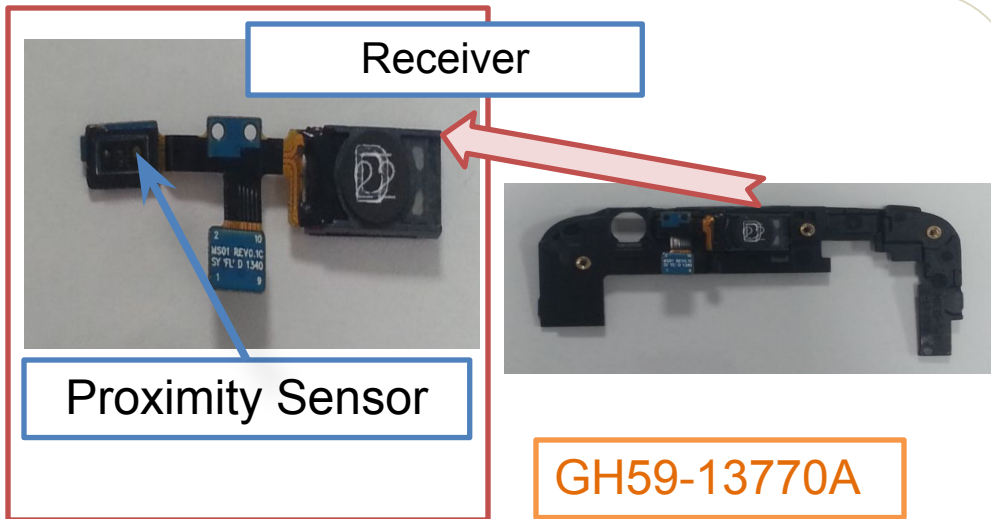

Microphone problem



Step	Check point	Result value	Defect point
1	Confirm the defect symptom	-	-
2	Check the microphone hole	Dust	Clean the hole
		Normal	Go to the next step
3	Check the microphone rubber	Wrong insert	Re-insert
		Normal	Go to the next step
4	Activate the speaker path (*#0283# → Packet Loopback ON)	-	-
5	Check the voltage of C501	1.8V	Go to the next step
	Notice. It should be measured when the microphone path is activated on	If not the correct value	AUDIO CODEC(U502)
6	Check the signal of ZD509,ZD5510	Same signal compared with a good PBA	Microphone
	Notice. It should be measured when the microphone path is activated on	If not the correct value	AUDIO CODEC(U502)

Microphone problem

Step2,3

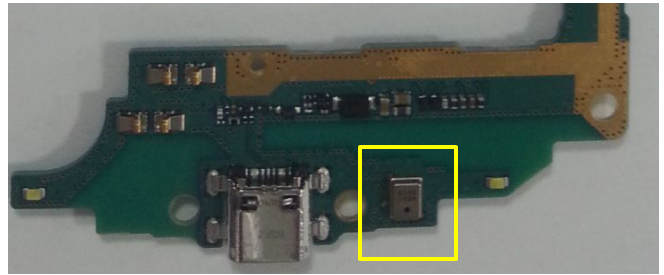

Microphone

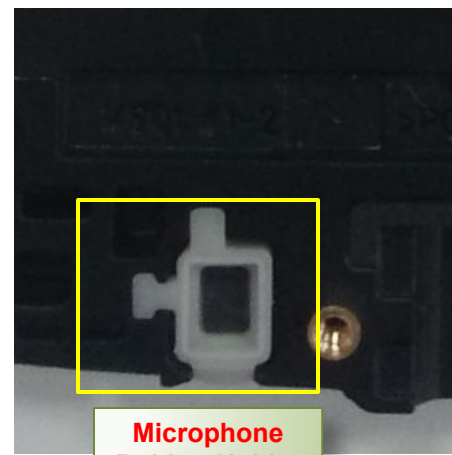

Microphone Rubber Holder

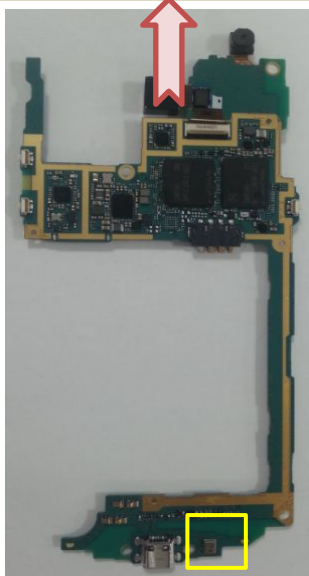

Step6

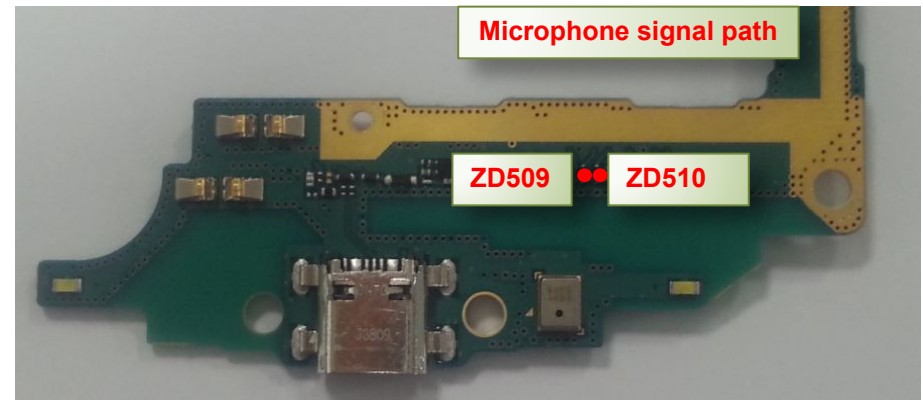

Microphone signal path

ZD509

ZD510

U605 Audio Codec

SIM card detection problem

Step	Check point	Result value	Defect point
1	Confirm the defect symptom	-	-
2	Check the SIM socket & Connector	Broken, dust, corrosion	SIM socket
		Normal	Go to the next step
3	Power on with a power supply (power supply voltage : 3.8V)	-	-
4	Check the signal of R618 for SIM601(UIM1) R629 for SIM600(UIM2) Notice. It should be measured when the phone is started	3V or 3V clock	Go to the next step
		If not the correct value	Call Processor (UCP300)
5	Check the signal of SIM socket pin1 (C636) (C640) Notice. It should be measured when the phone started	3V	SIM socket
		If not the correct value	PMIC (U401)

SIM card detection problem

Step4

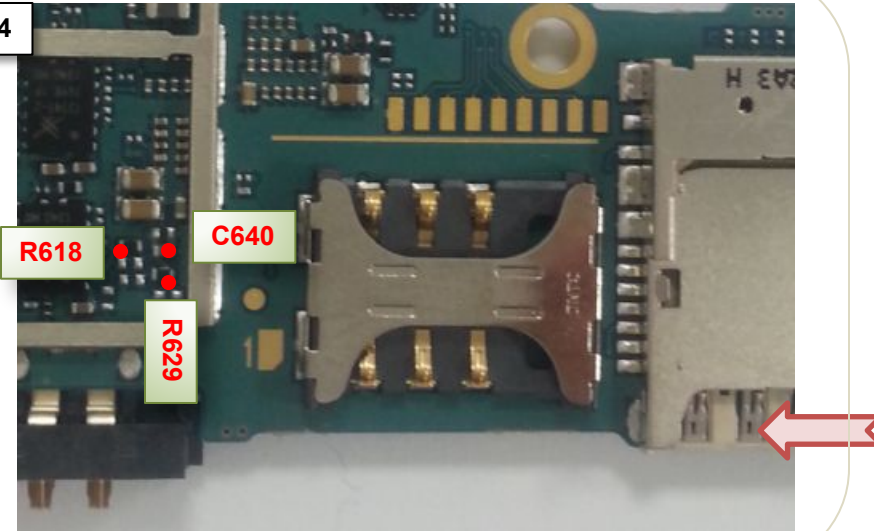

Step 2

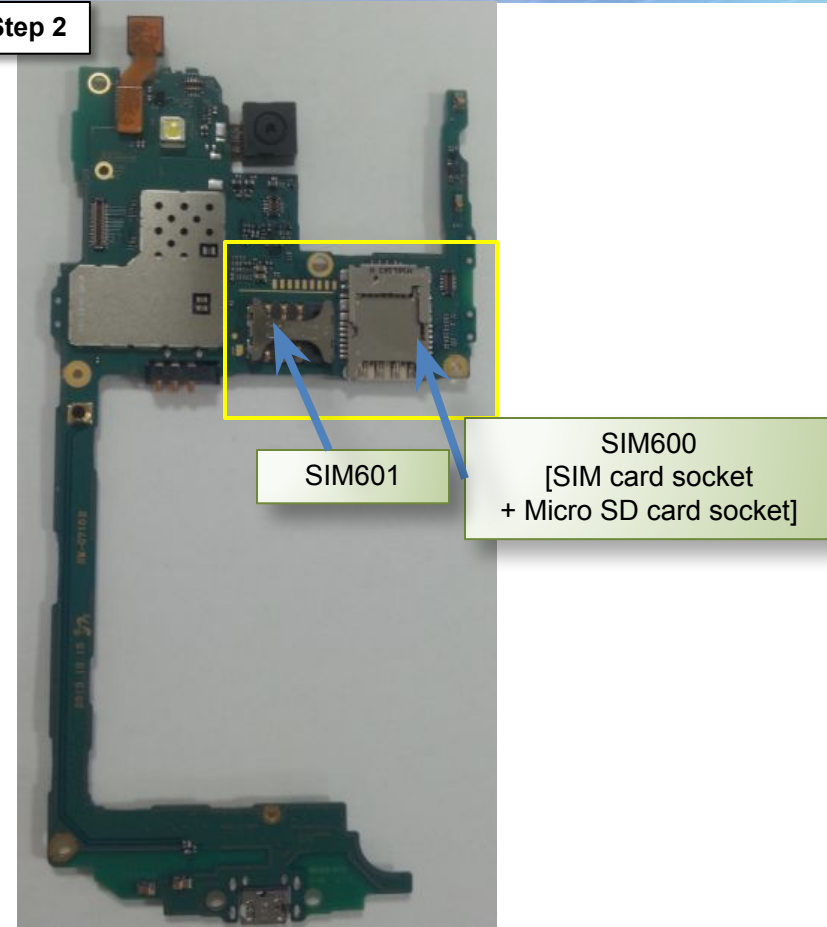

Step5

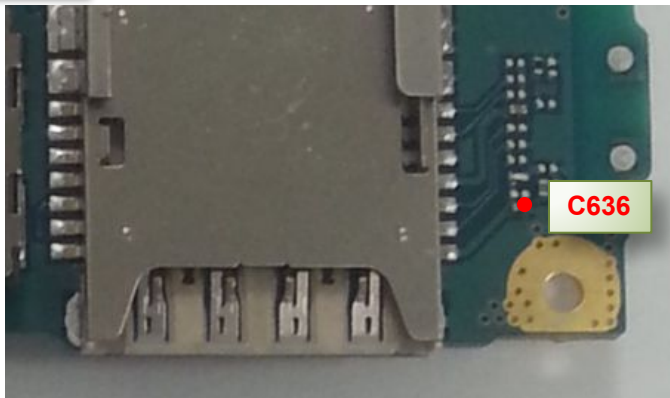

- Question

