

Оригами

(работа с бумагой на уроках
технологии)

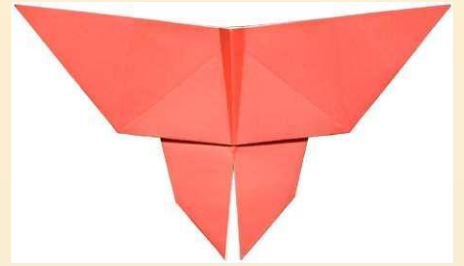

ОРИГАМИ



Оригами - удивительное искусство бумажной пластики, родившееся в Японии.

Бумага - одно из самых великих изобретений человечества - родилась на Востоке, и именно там, на рубеже тысячелетий, появились первые бумажные фигурки.

За свою многовековую историю Оригами прошло путь от храмовых



оряще



у ми



м



Условные обозначения



Линия сгиба
«долиной»,
«на себя»

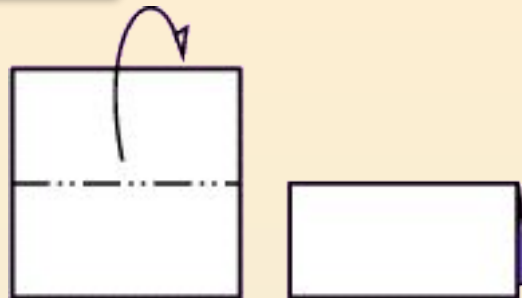
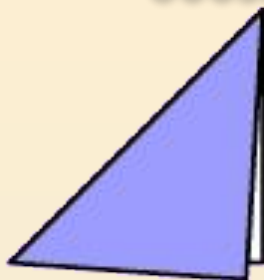

Линия сгиба «от
себя»



Согнуть и
разогнуть



Существующая
линия,
след сгиба

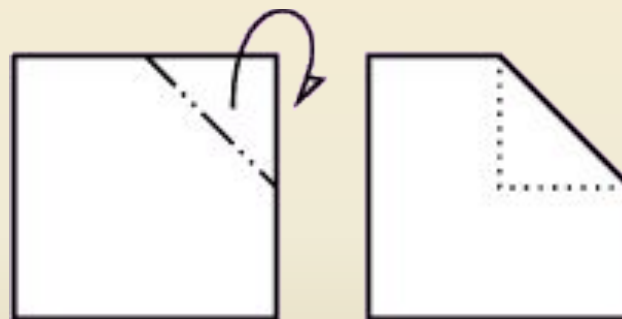

Невидимая, скрытая
линия



Совместить отмеченные точки



Раздвинуть слои бумаги

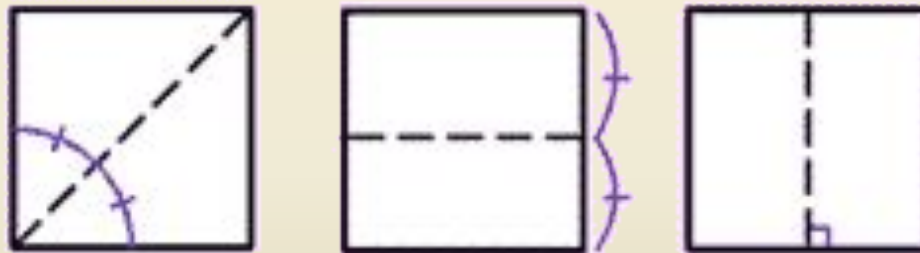

Равные углы, равные отрезки, прямой угол



Повернуть
фигуру



Перевернуть
фигуру



Сгиб
гармошкой

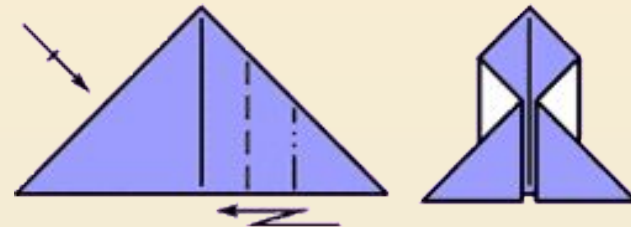

Вытащить, открыть, вывернуть,
развернуть

Нажать,
затолкнуть



Сделать
надрез



Дунуть,
надуть



Лодочк

а



1

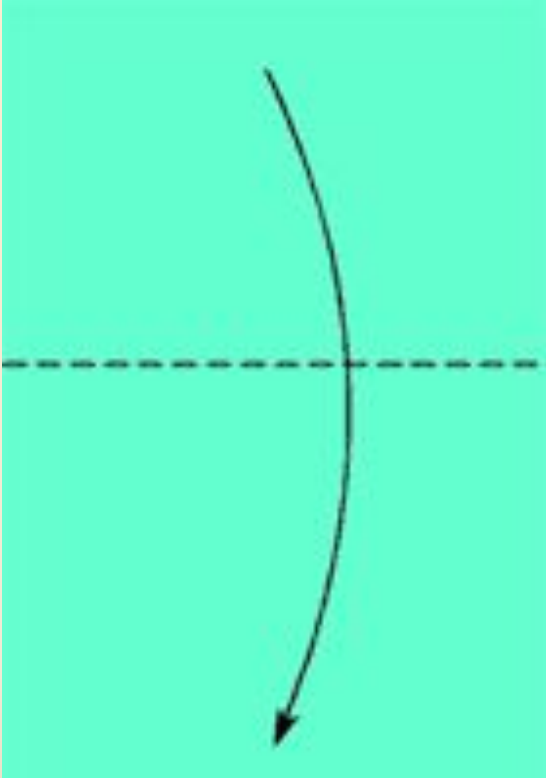

2

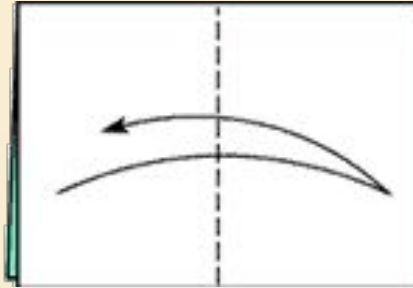

3

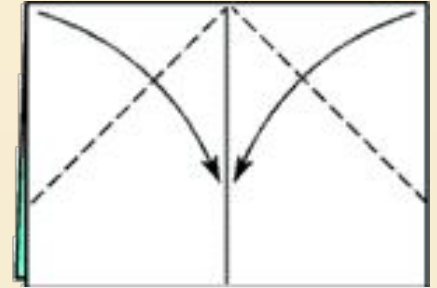

4

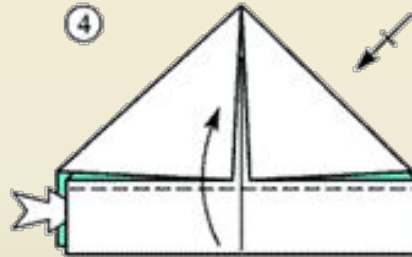

5

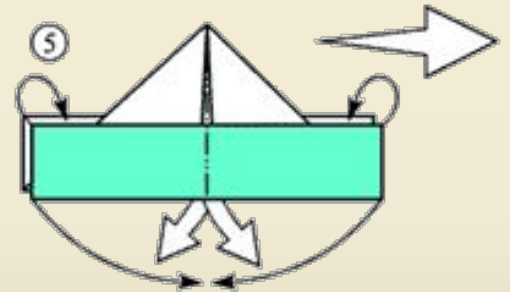

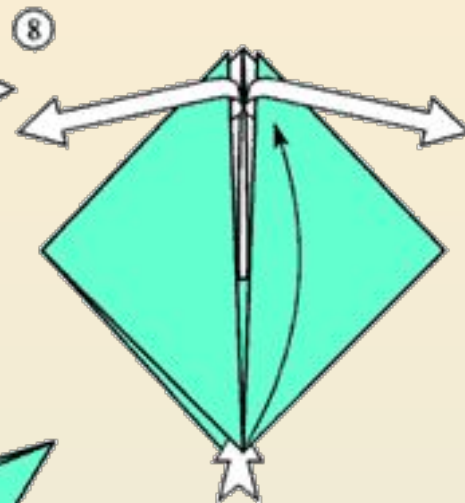
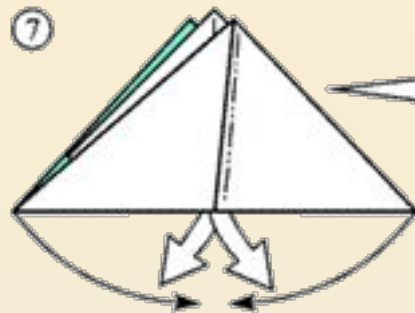
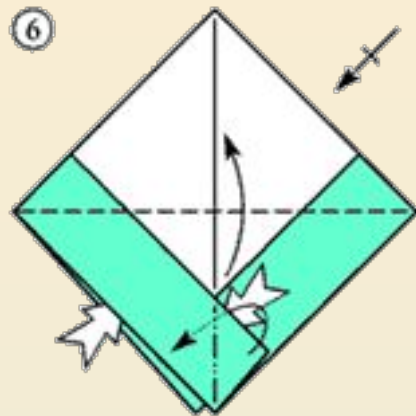

Самол

ёт



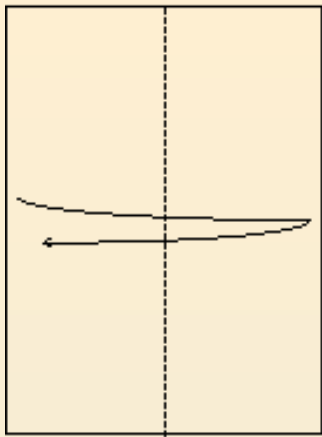

1

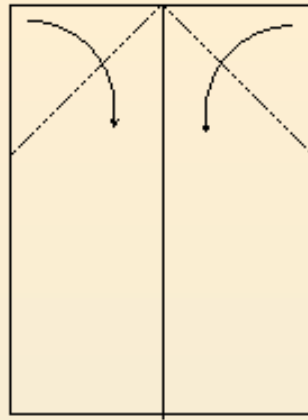

2

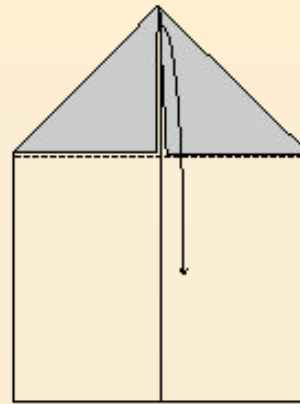

3

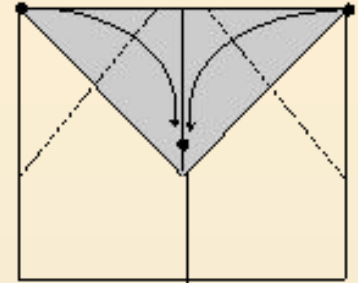

4

1. Наметьте среднюю линию.

2. Сложите углы к средней линии.

3. Сложите верхний угол вниз.

4. Сложите углы, совмещая вершины.

5. Загните уголок вверх, закрепляя два верхних угла.

6. Сложите модель пополам.

7. Расправьте крылья.

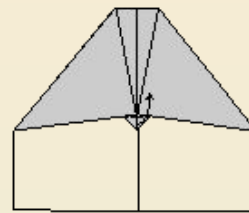

5

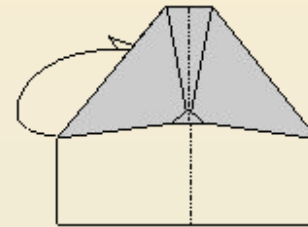

6

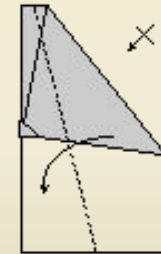

7

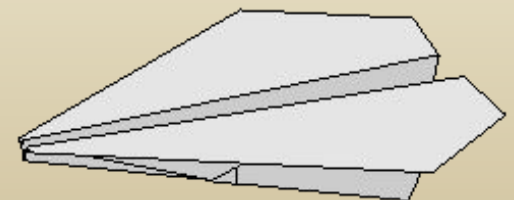



Лягушк

а



①

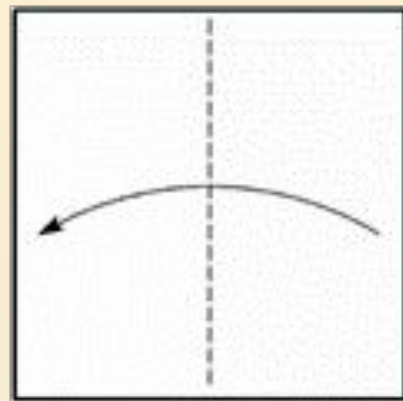

②



③

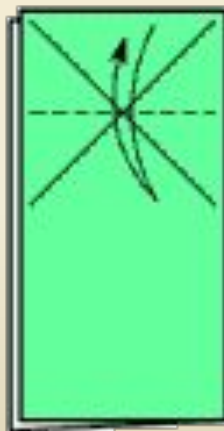

④

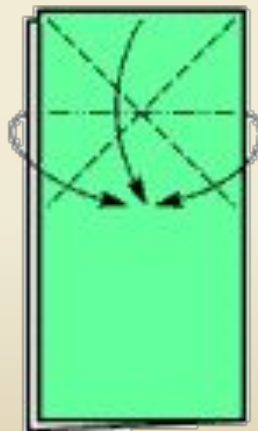

⑤

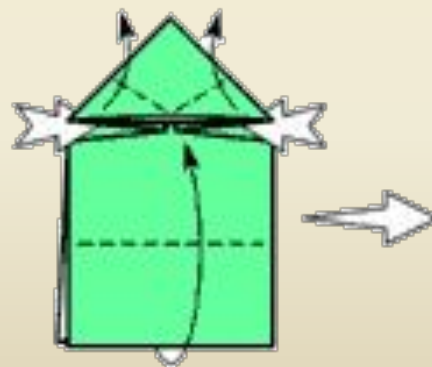

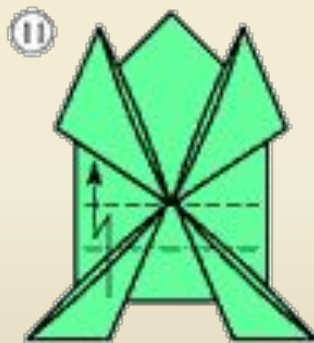
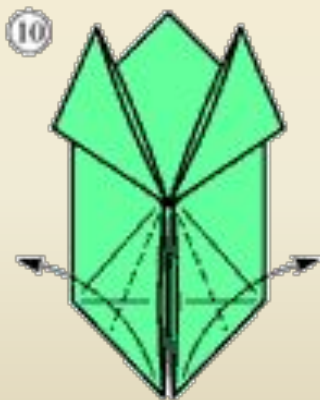
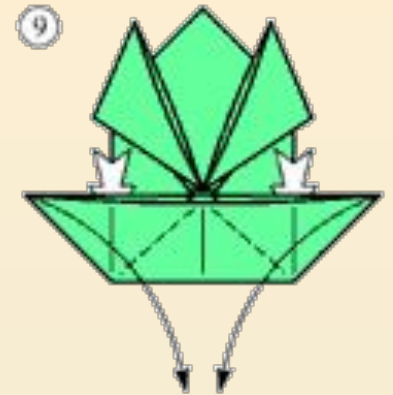
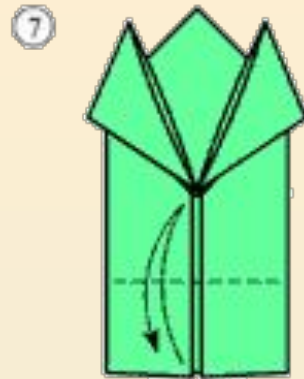
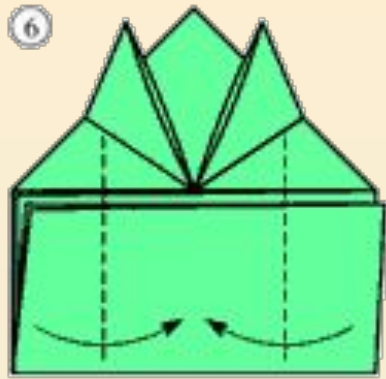



Стака

Н



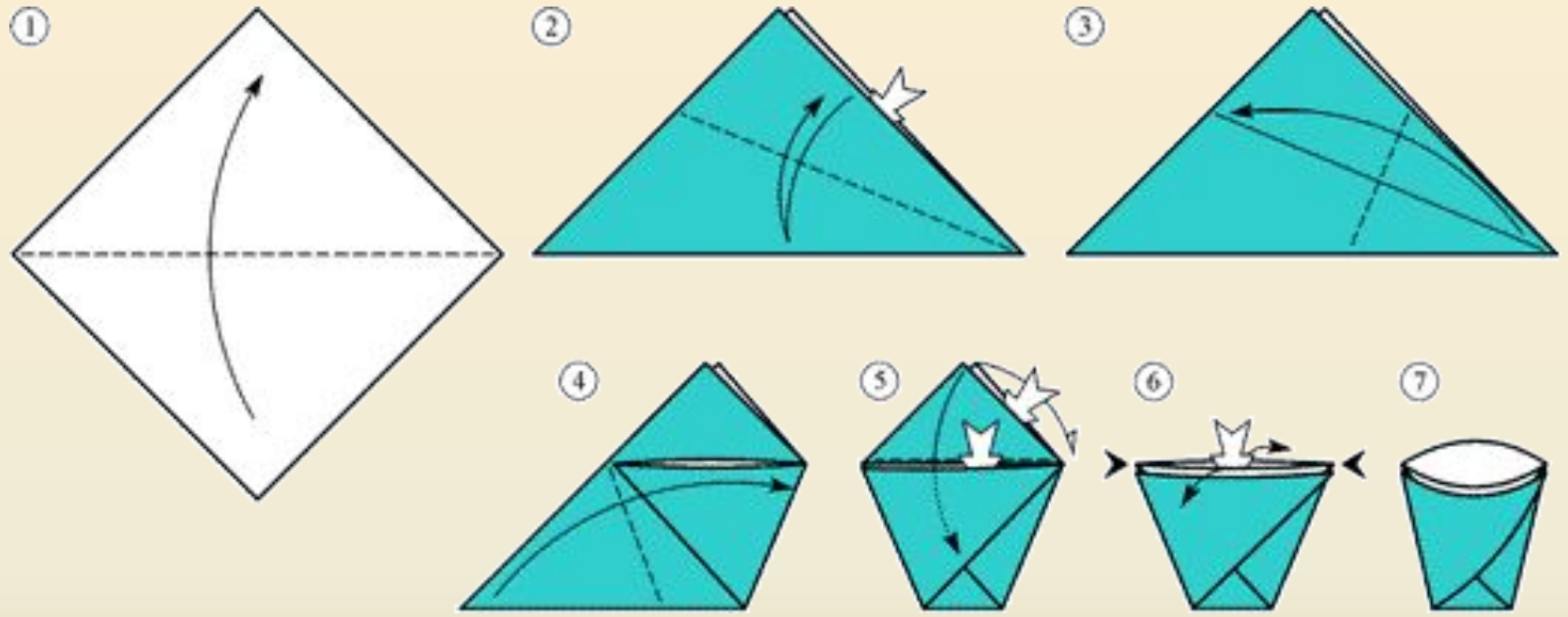

Парохо

Д



①

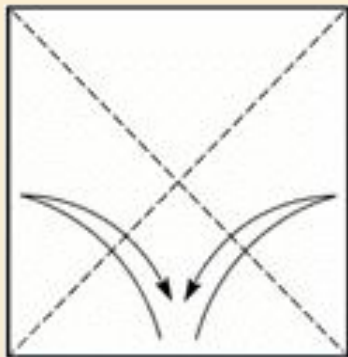

②

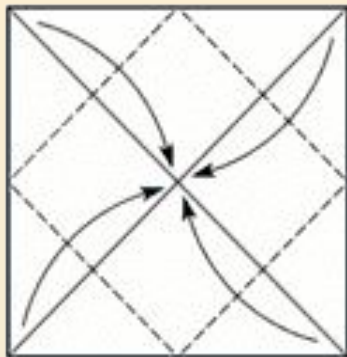

③

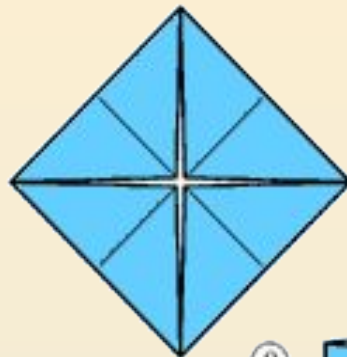

④

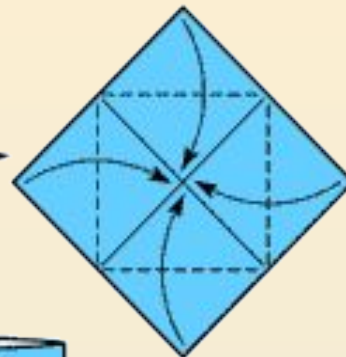

⑤



⑦



⑥



⑧



⑨

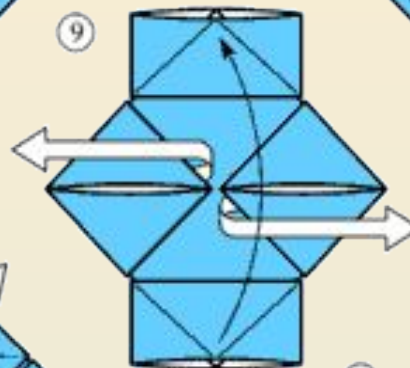

⑩

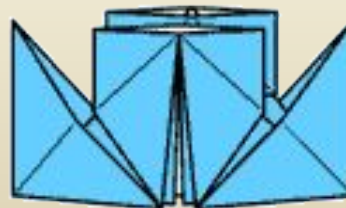



Бабочк

а



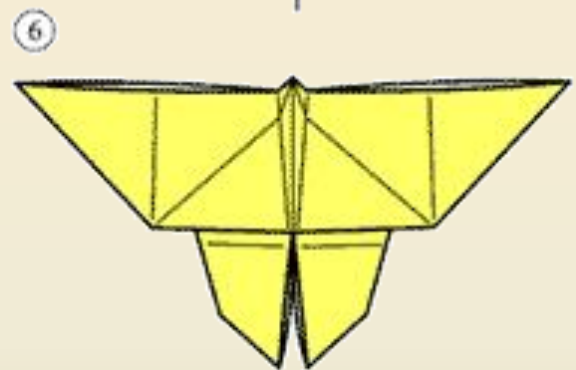
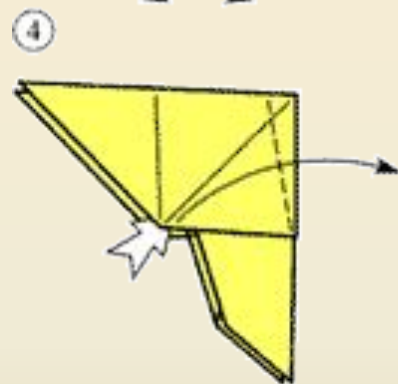
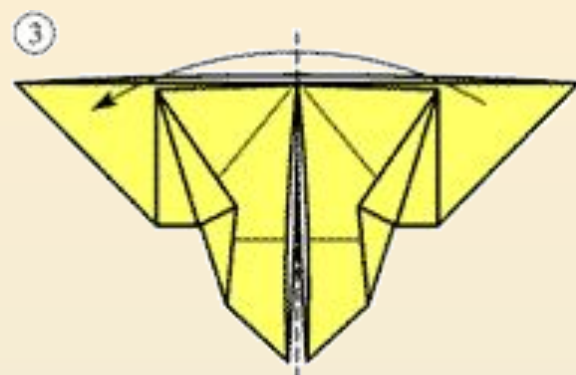
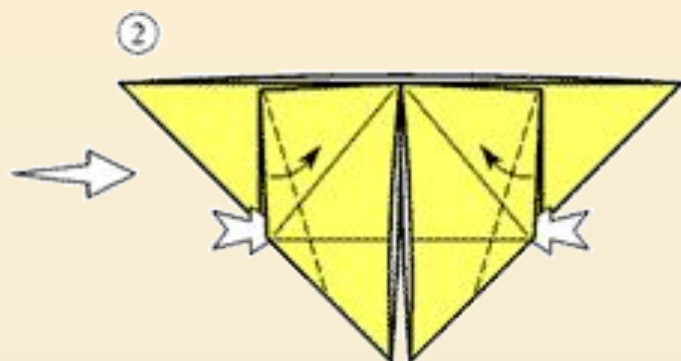
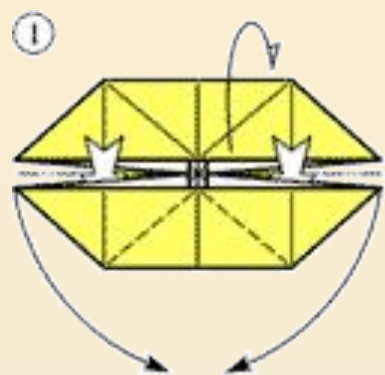

Водяная бомбочка

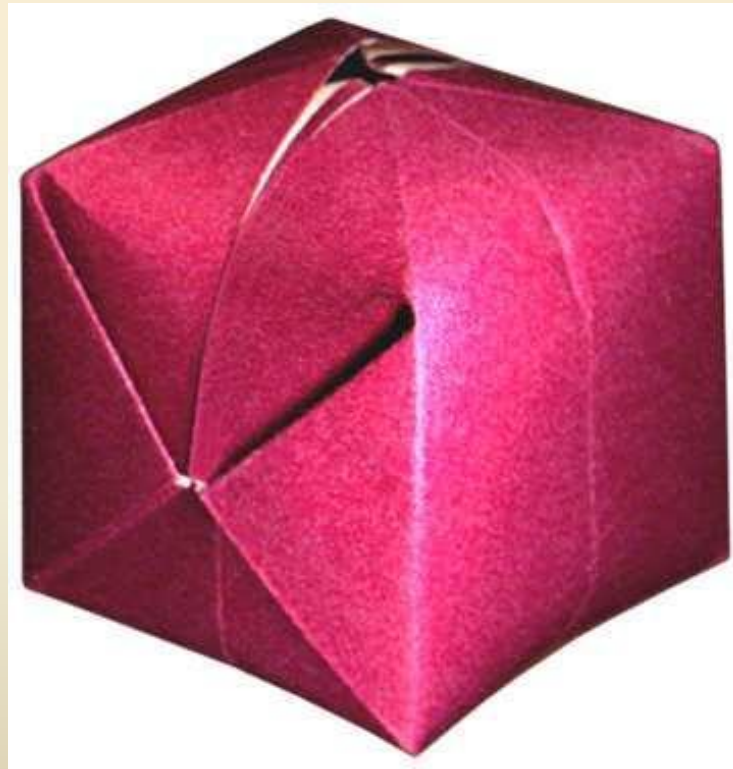

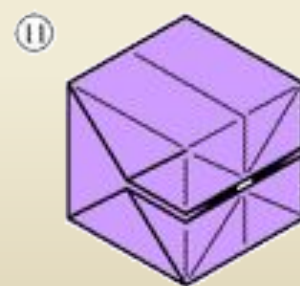
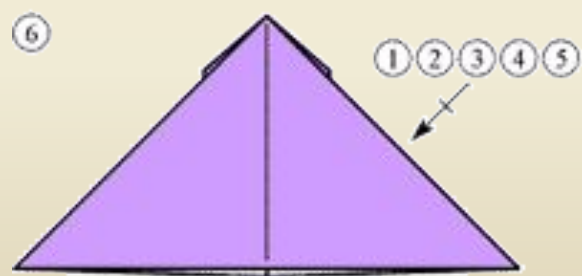
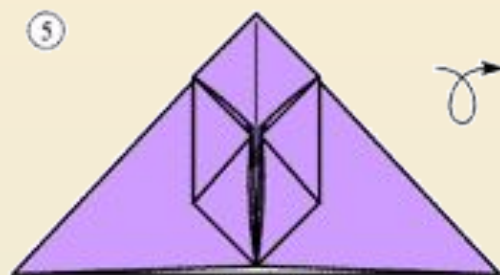
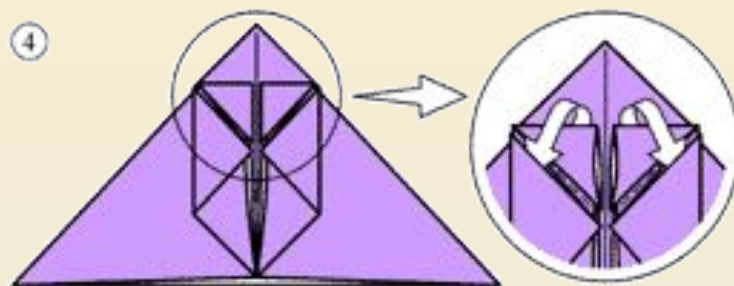
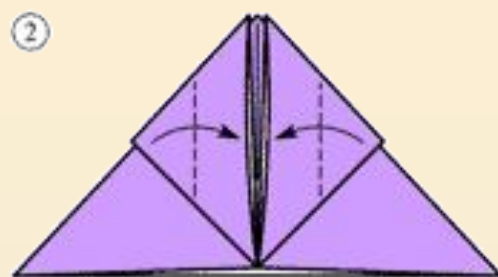
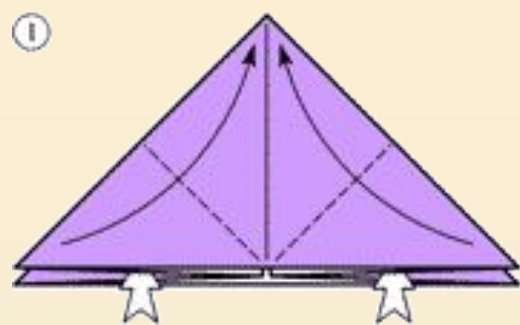

Вертуш

ка

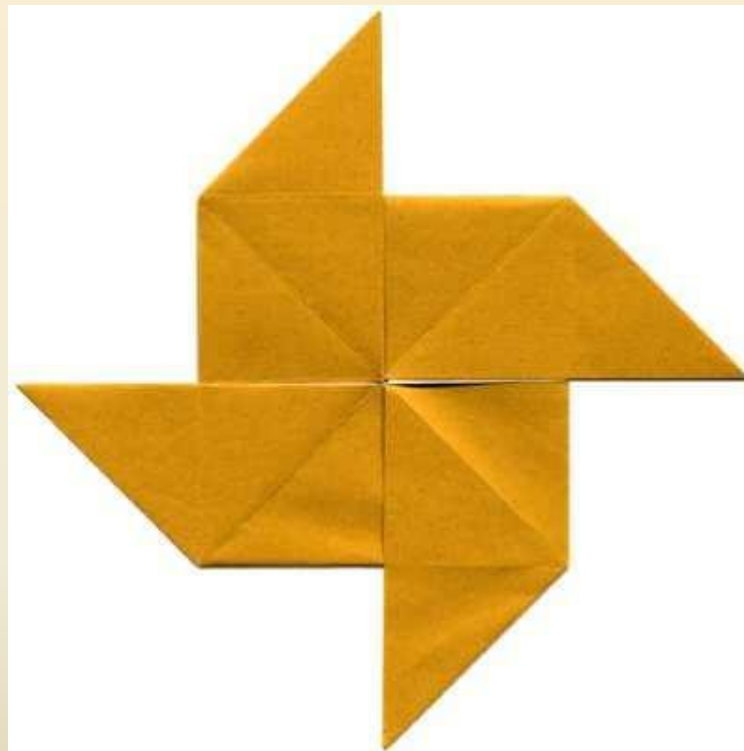

①



②

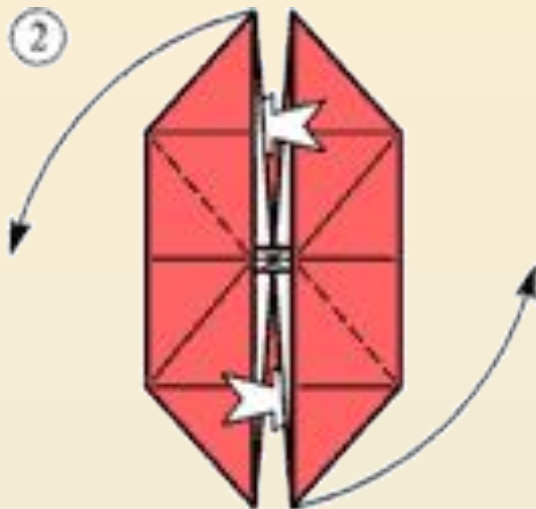

③

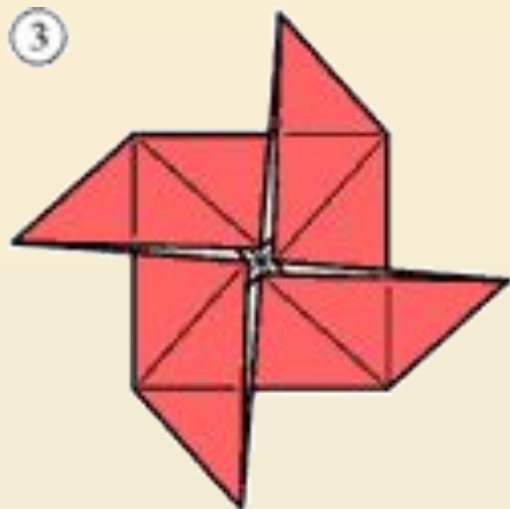

Коробочк

а

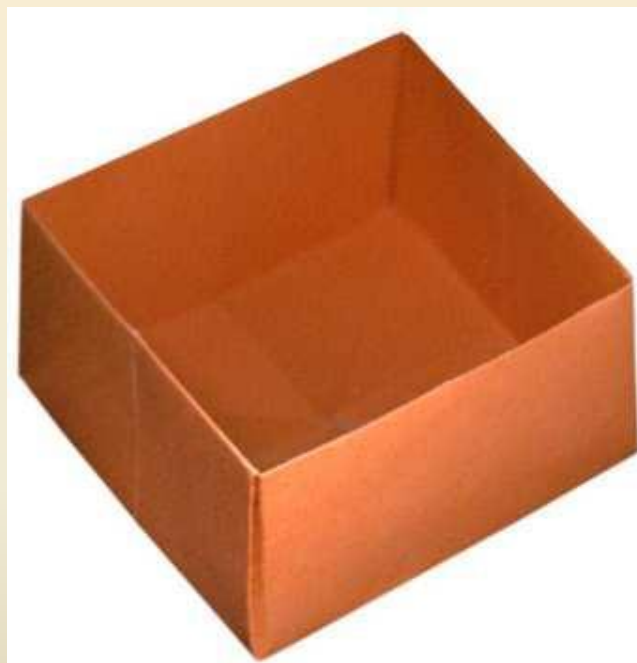

1

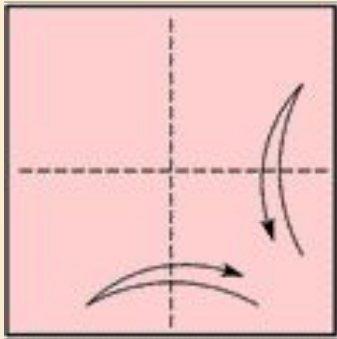

2

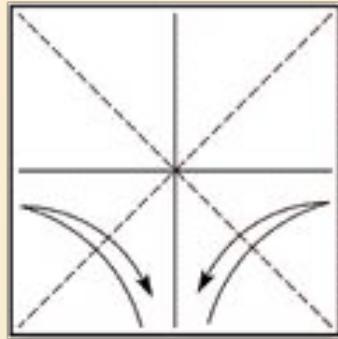

3

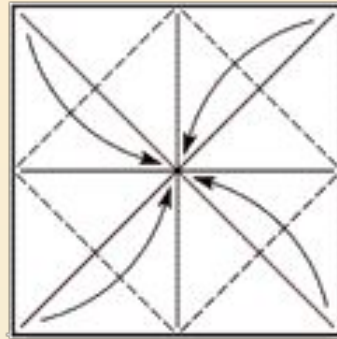

4



4

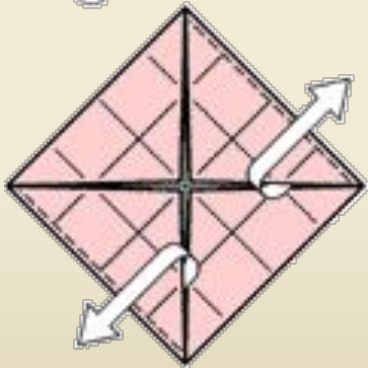

5

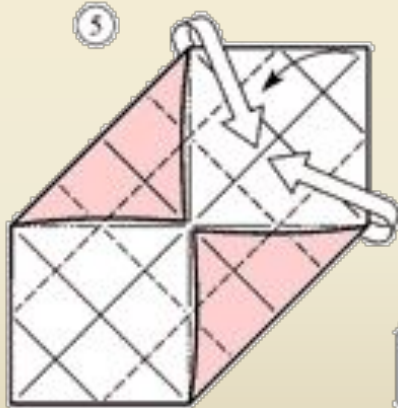

6

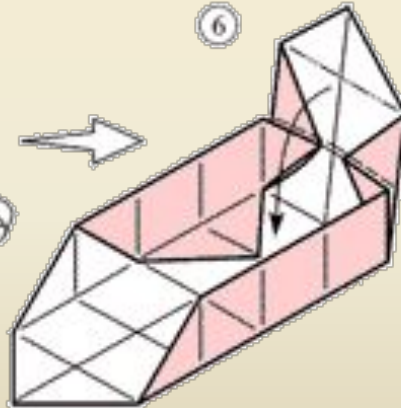

7

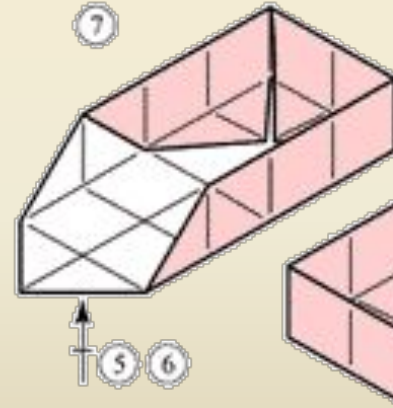

8



Голу

бъ



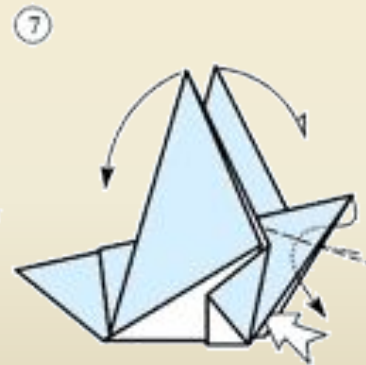
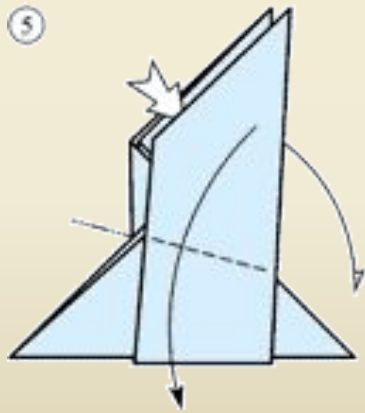
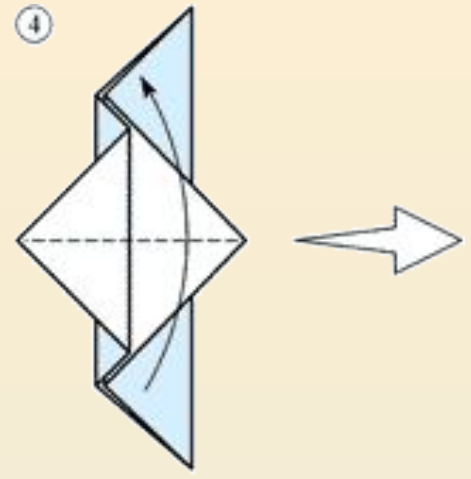
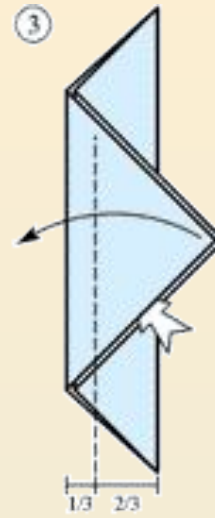
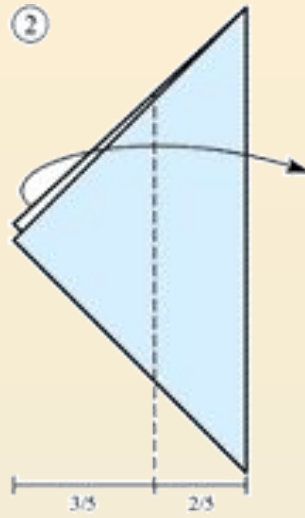
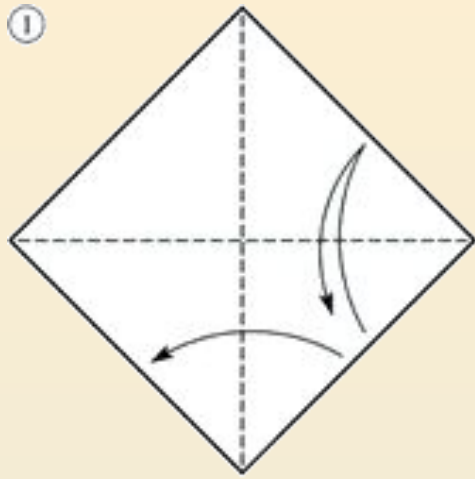

Журавл

ИК



1. Согните квадрат по диагонали и разогните.
2. Согните квадрат по другой диагонали разогните.
3. Согните по направлению от себя и разогните.
4. Согните по направлению от себя и разогните.
5. Переверните на другую сторону.
6. Надавите приподнимая концы.
7. Сложите квадрат.
8. Согните "долиной" поля квадрата так, чтобы указанные линии образовывали равные углы и разогните.

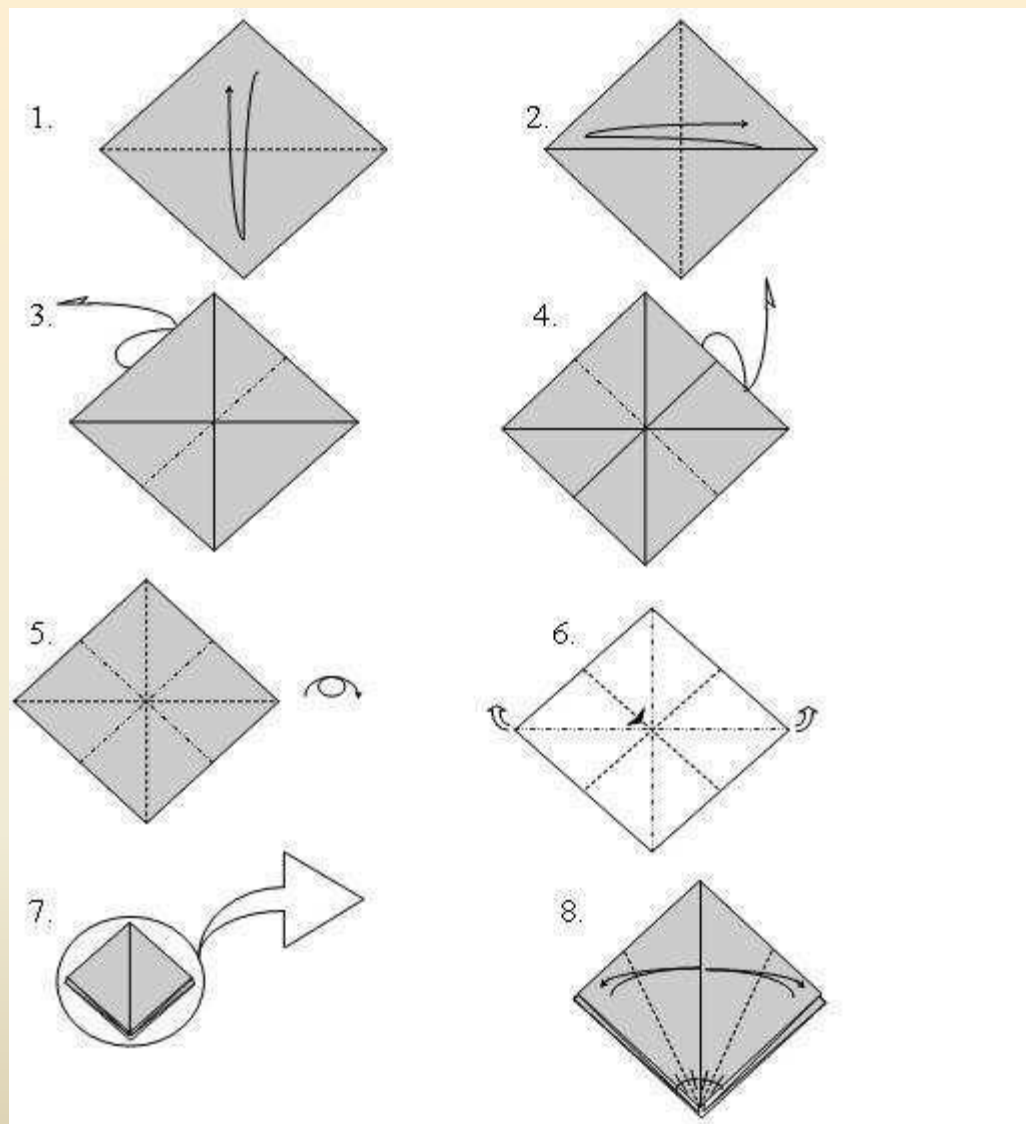

9. Раскройте, приподнимая верхний слой за нижний угол квадрата и одновременно вгибая края.

10. Переверните на другую сторону.

11. Согните "долиной" поля квадрата так, чтобы указанные линии образовывали равные углы и разогните.

12. Раскройте, приподнимая верхний слой

за нижний угол квадрата и одновременно вгибая края.

13. Получилась базовая форма "Птица".

14. Сложите так, чтобы линии сгиба делили

соответствующие углы пополам.

Поверните и повторите с обратной стороны.

15. Согните и разогните, намечая линии.

16. Вогните углы внутрь.

17. Вогните угол внутрь, формируя клюв.

18. Отогните крылья в горизонтальное положение.

19. Слегка потяните за крылья и

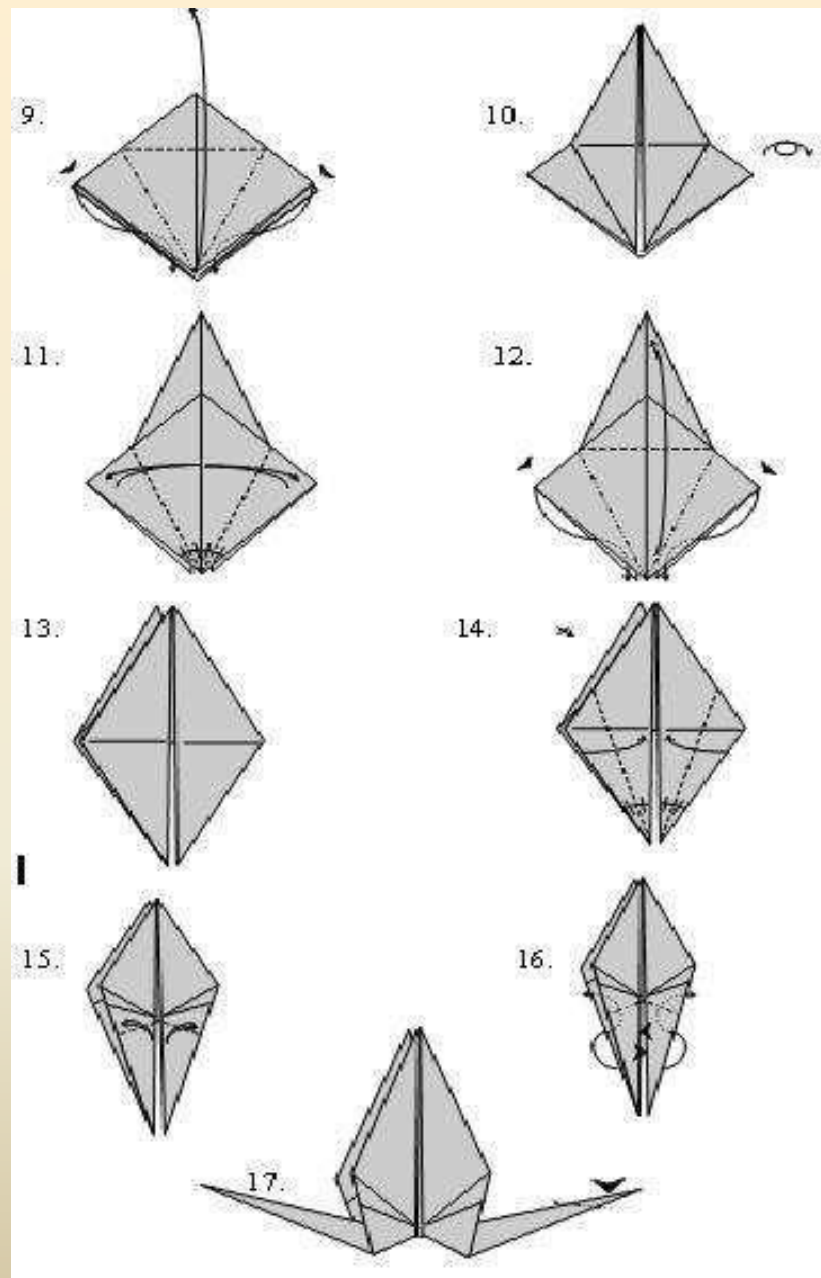

В презентации использованы материалы с сайта
www.origami.ru,
dorigami.narod.ru