

КОМПОЗИЦИЯ ИЗ ОБЪЕМНЫХ ГЕОМЕТРИЧЕСКИХ ФИГУР

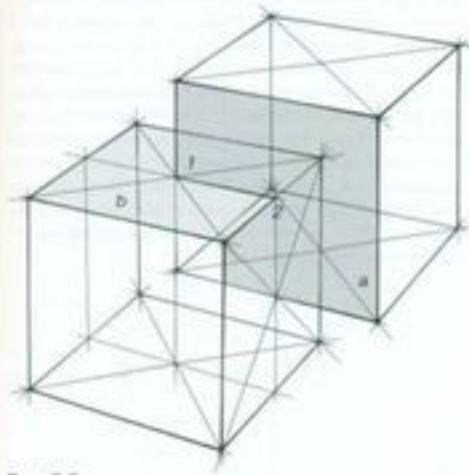

Pvc. 5.5

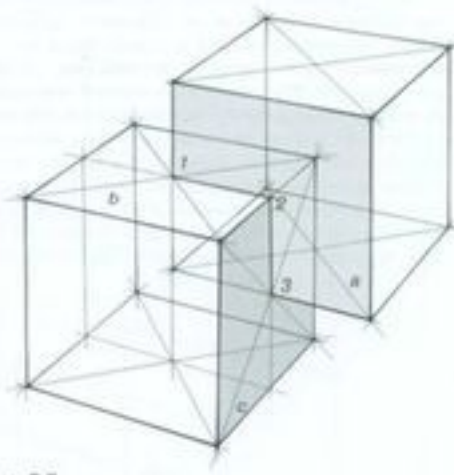

Pvc. 5.6

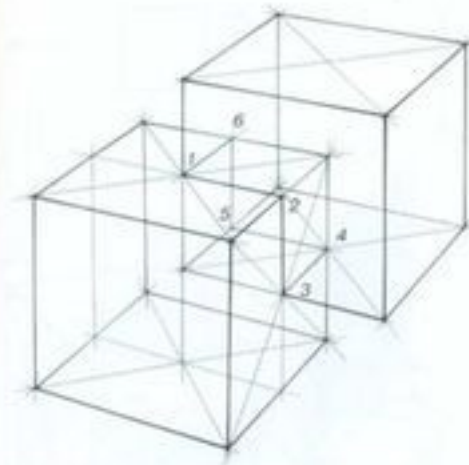

Pvc. 5.7

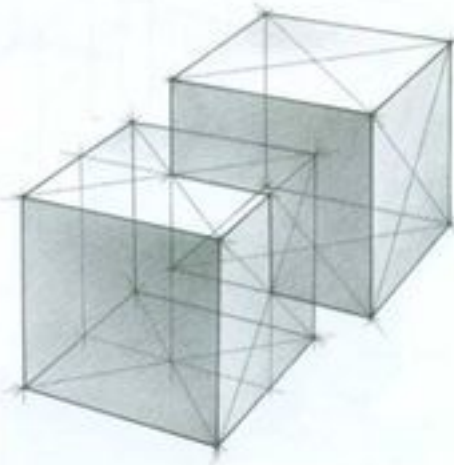

Pvc. 5.8



Рис. 5.206



Рис. 5.207

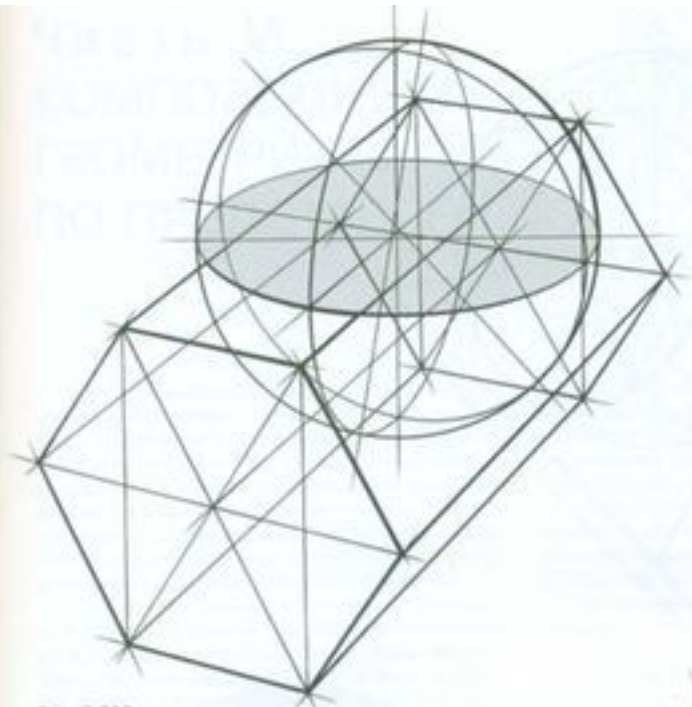

Рис. 5.186

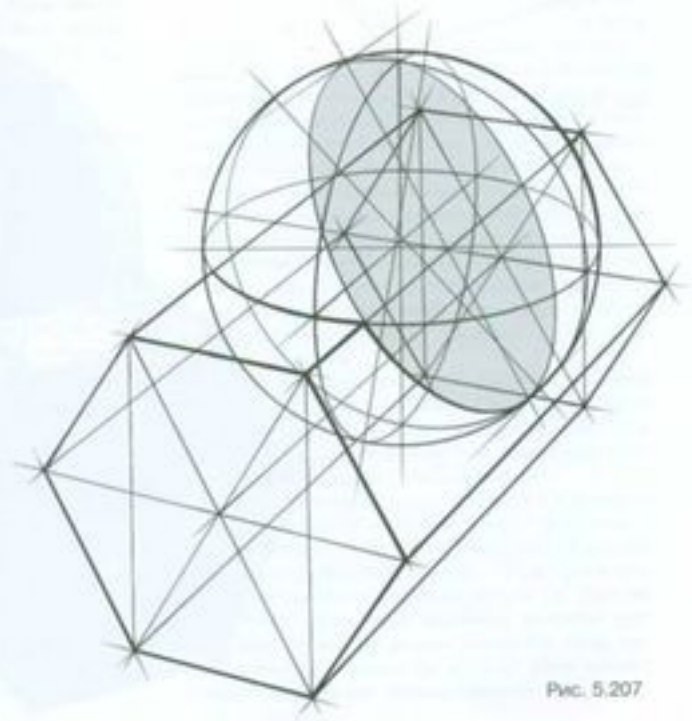

Рис. 5.187

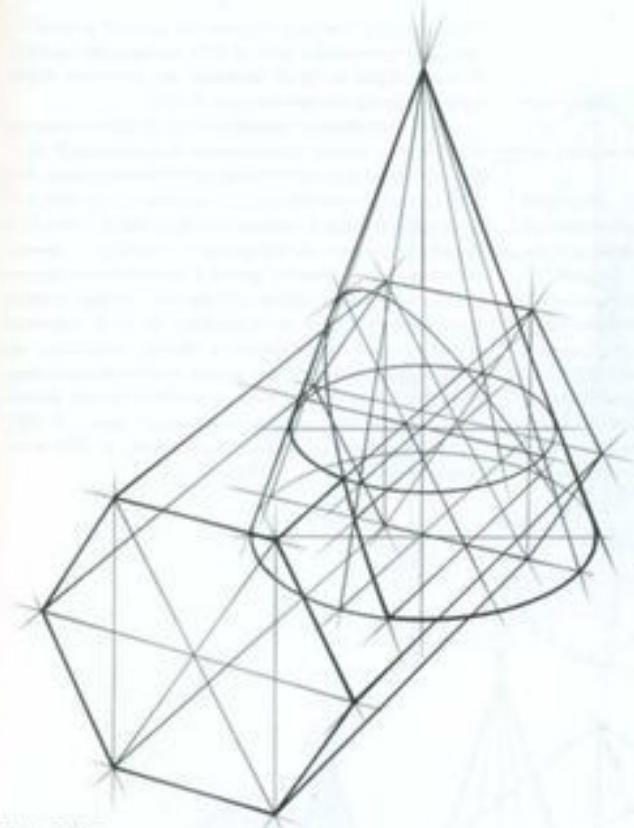

Рис. 5.110

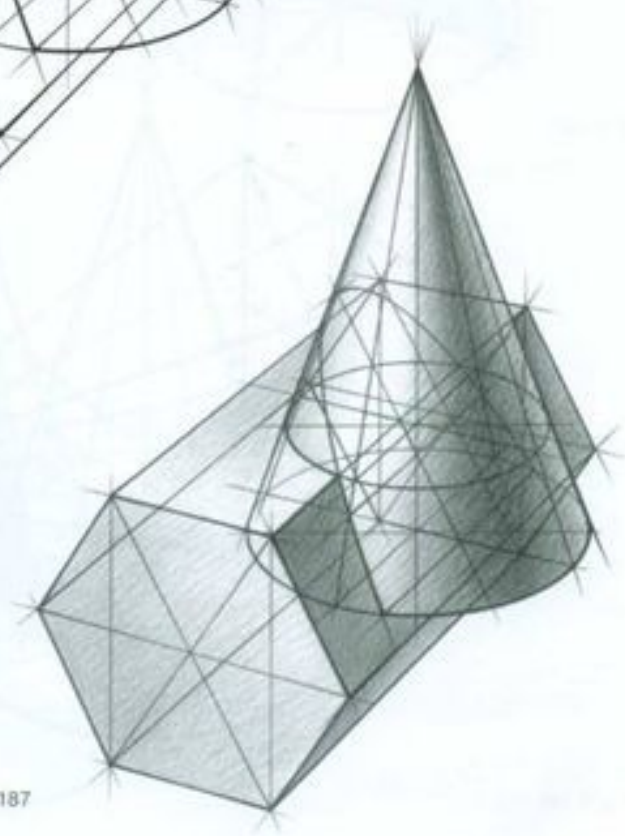

Рис. 5.111



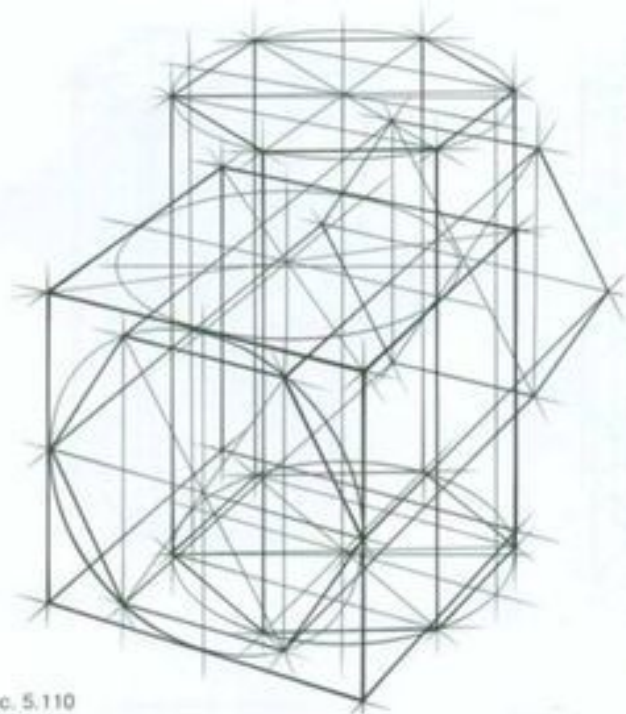

Рис. 5.114

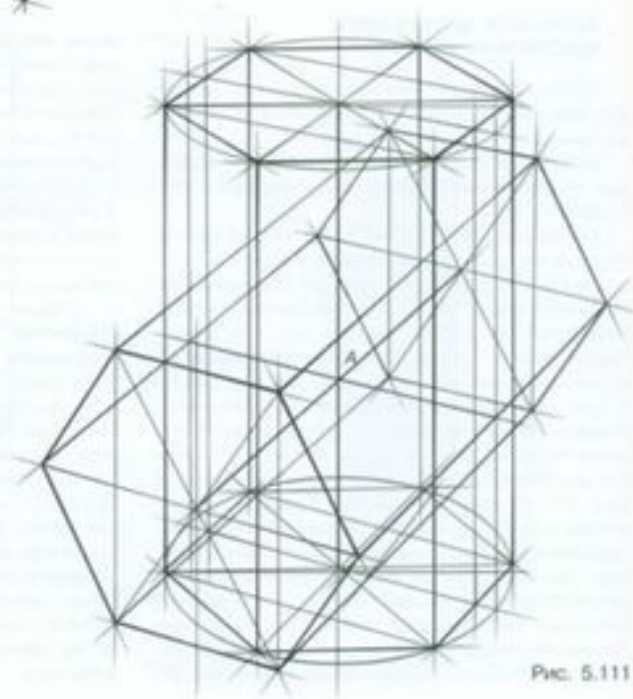
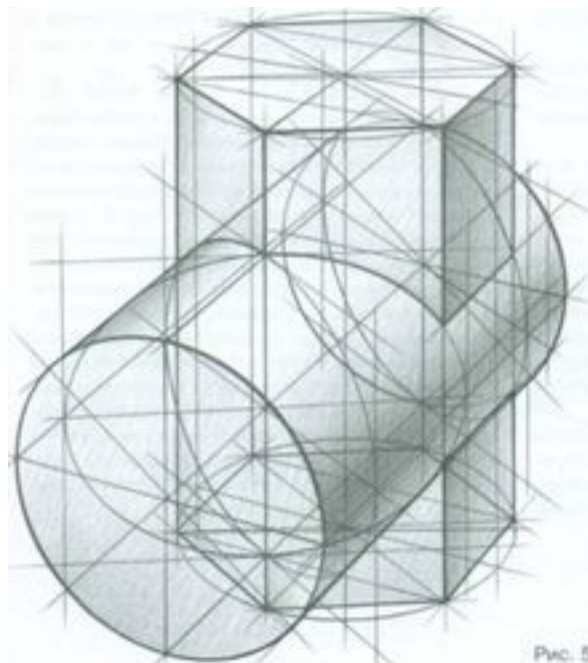
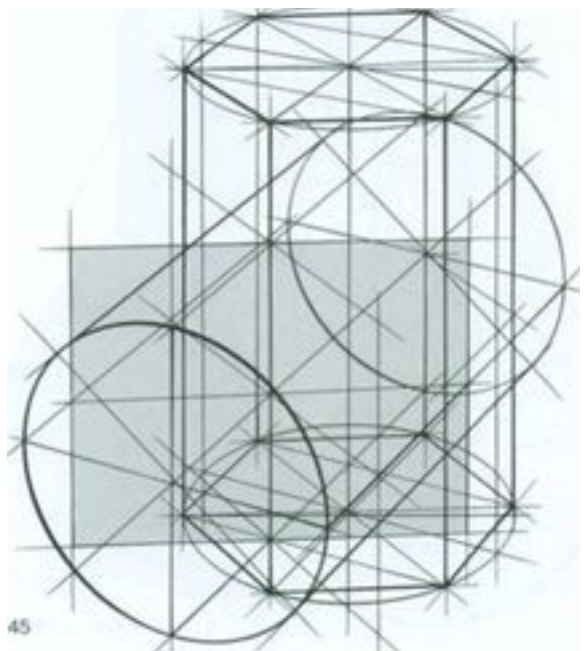
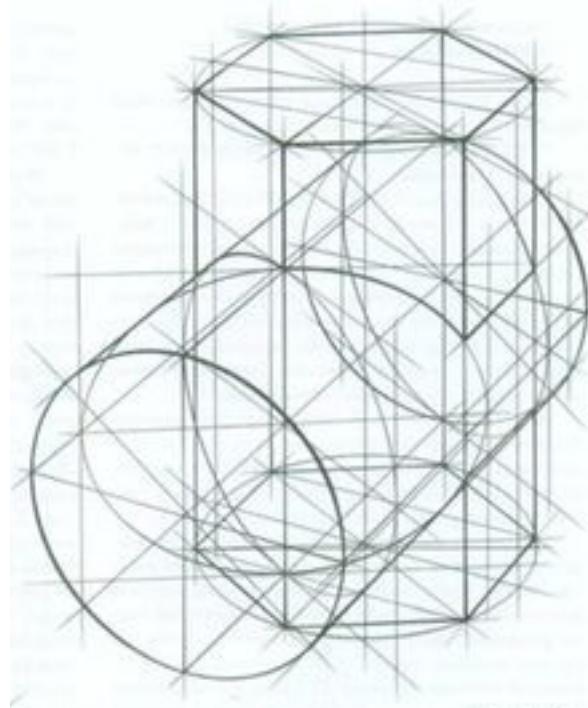
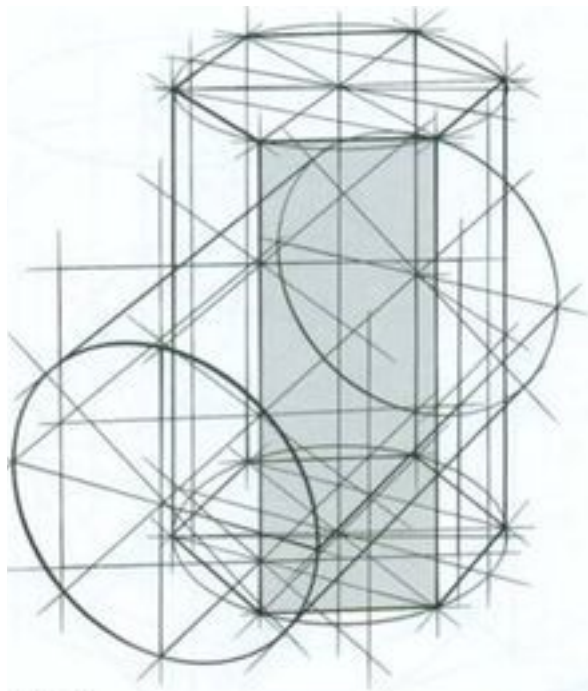

Рис. 5.115



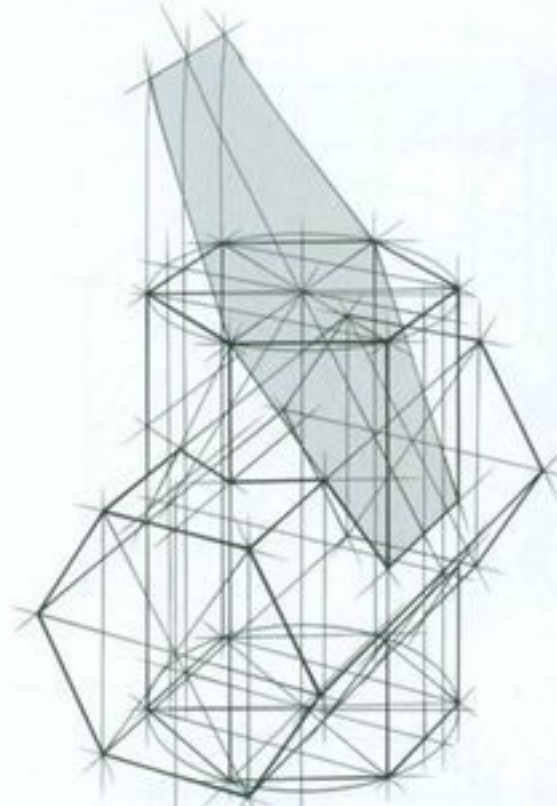



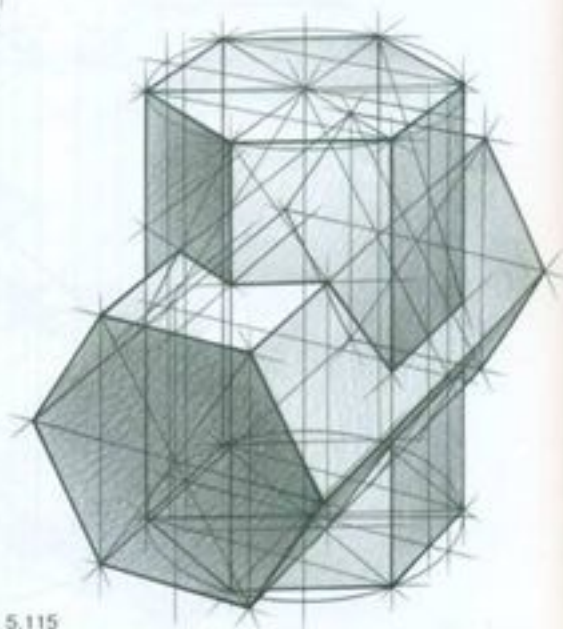
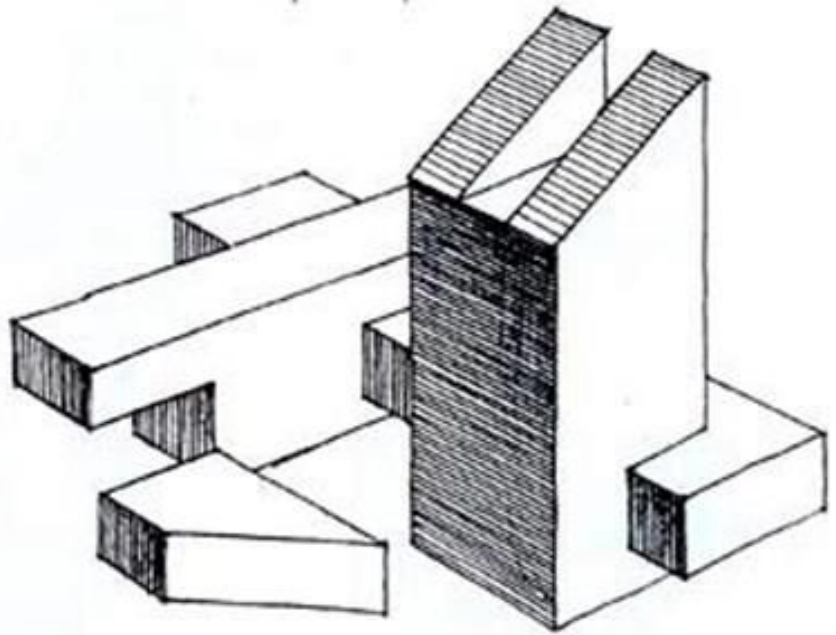
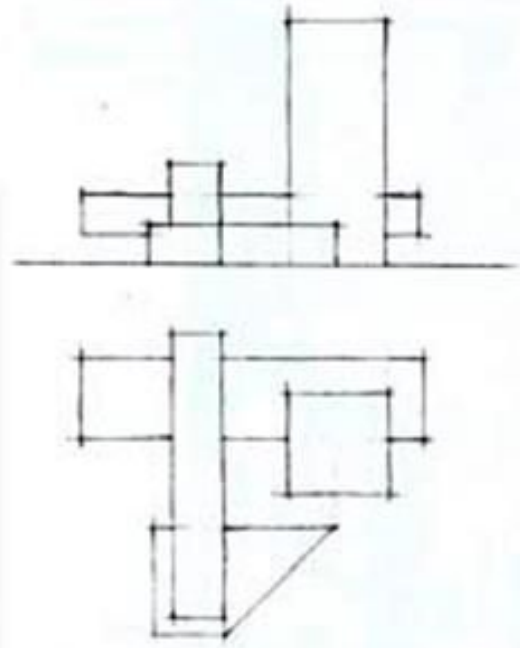
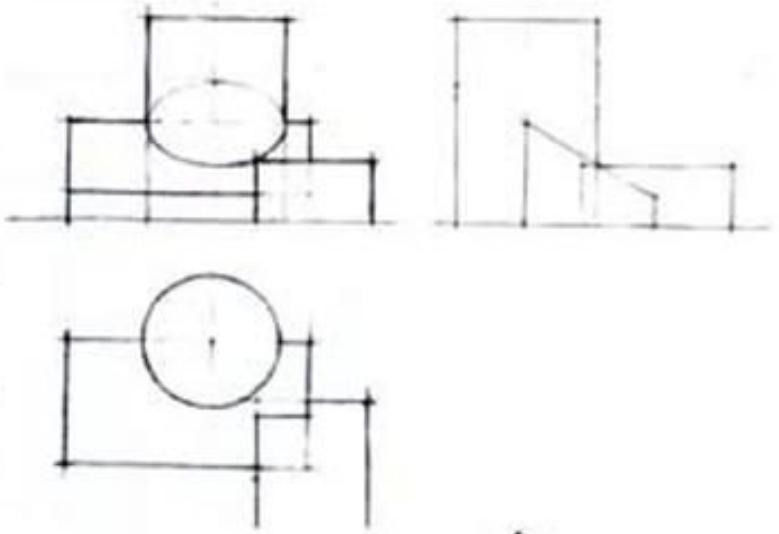
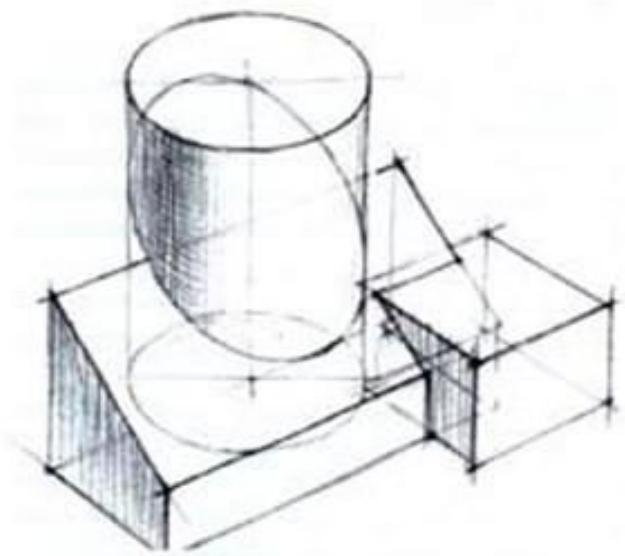
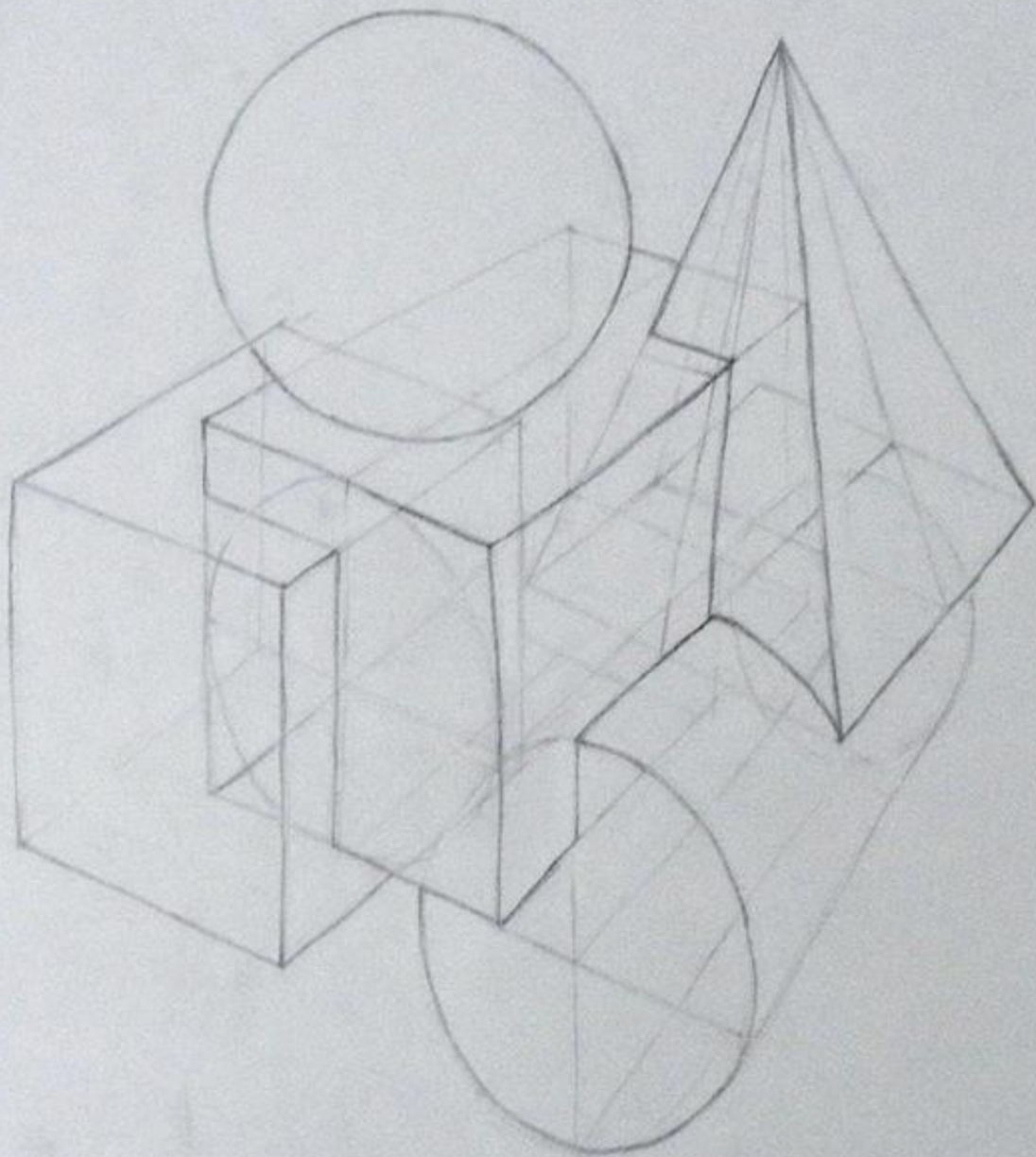
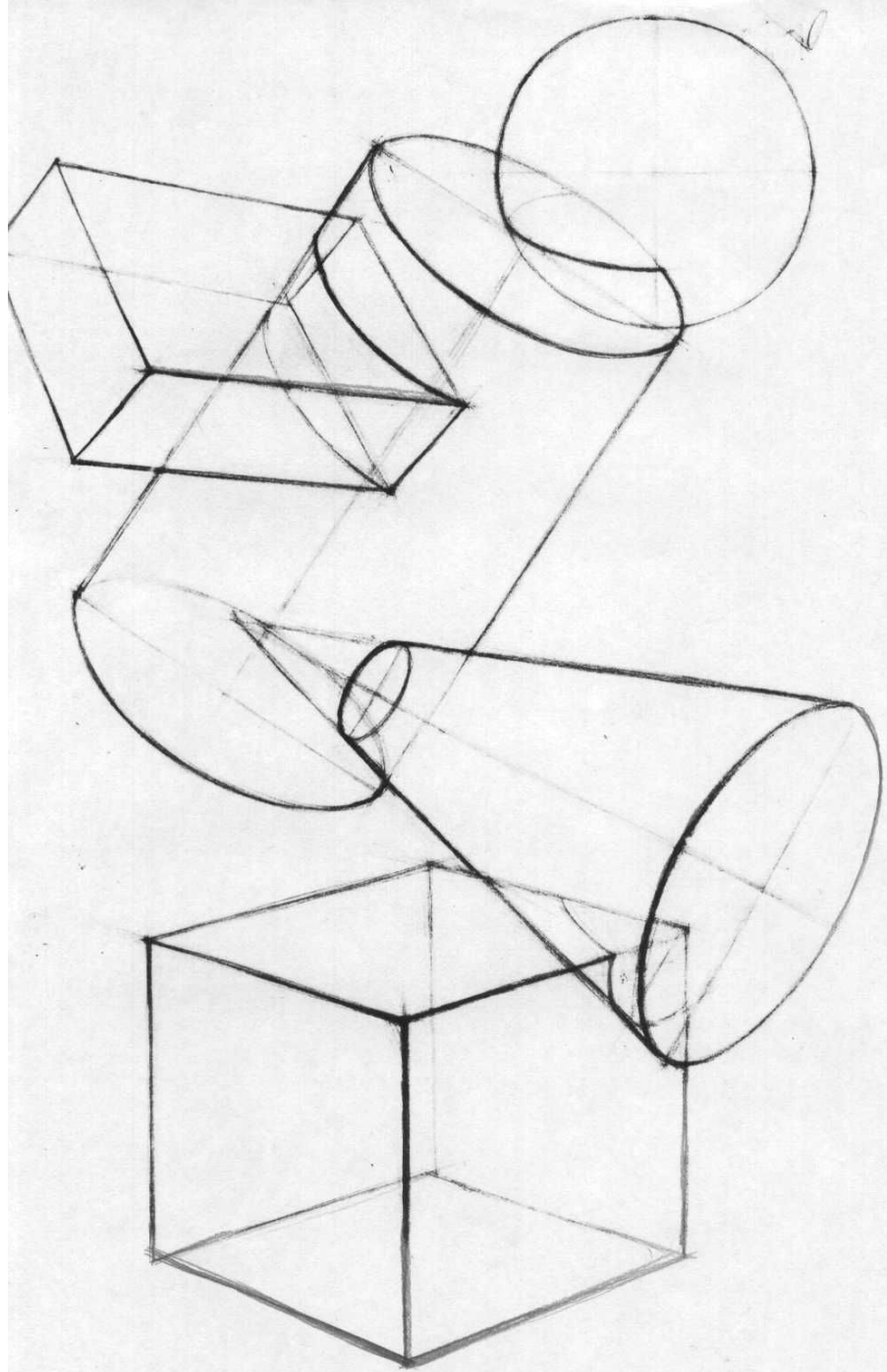
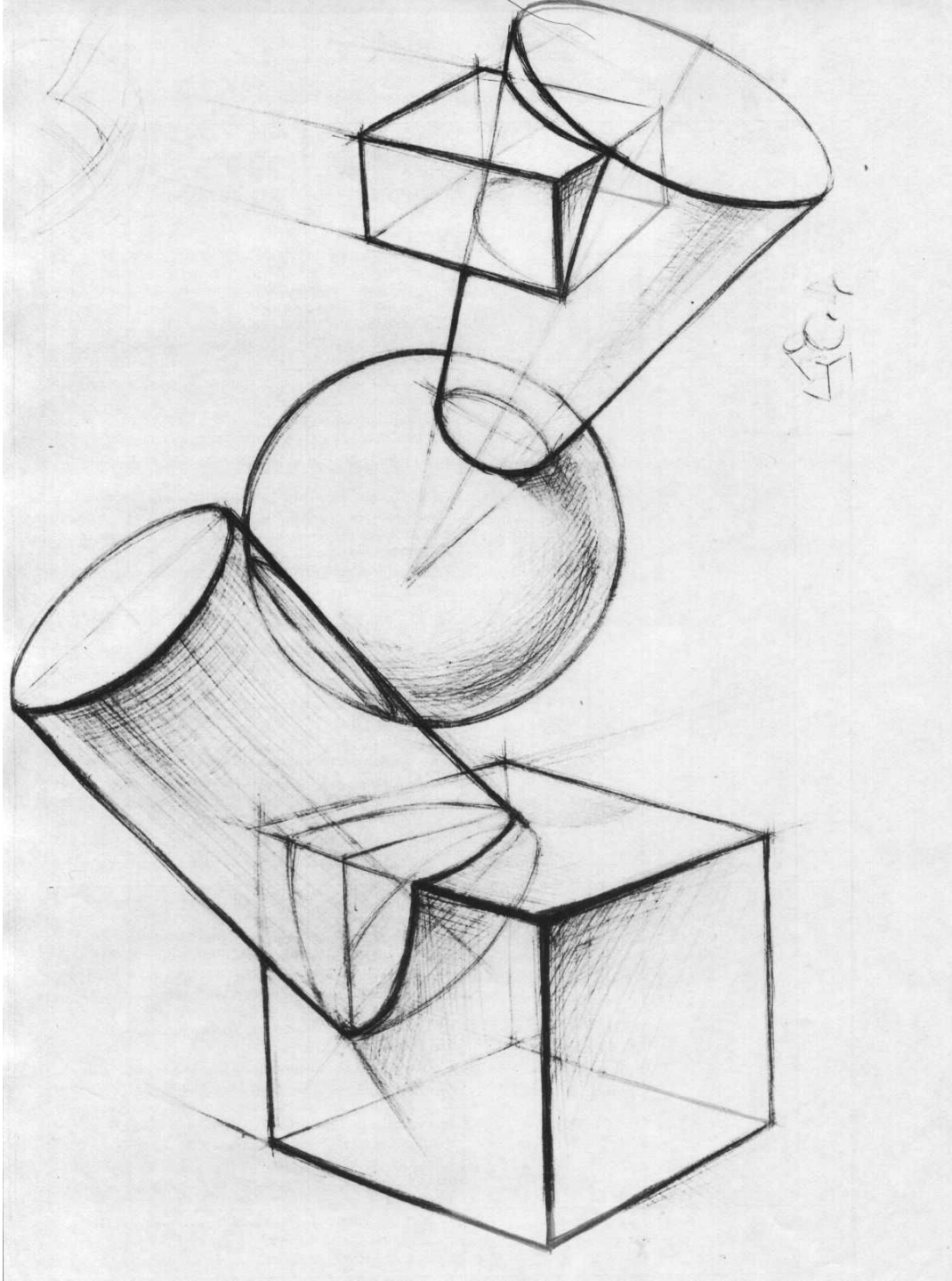

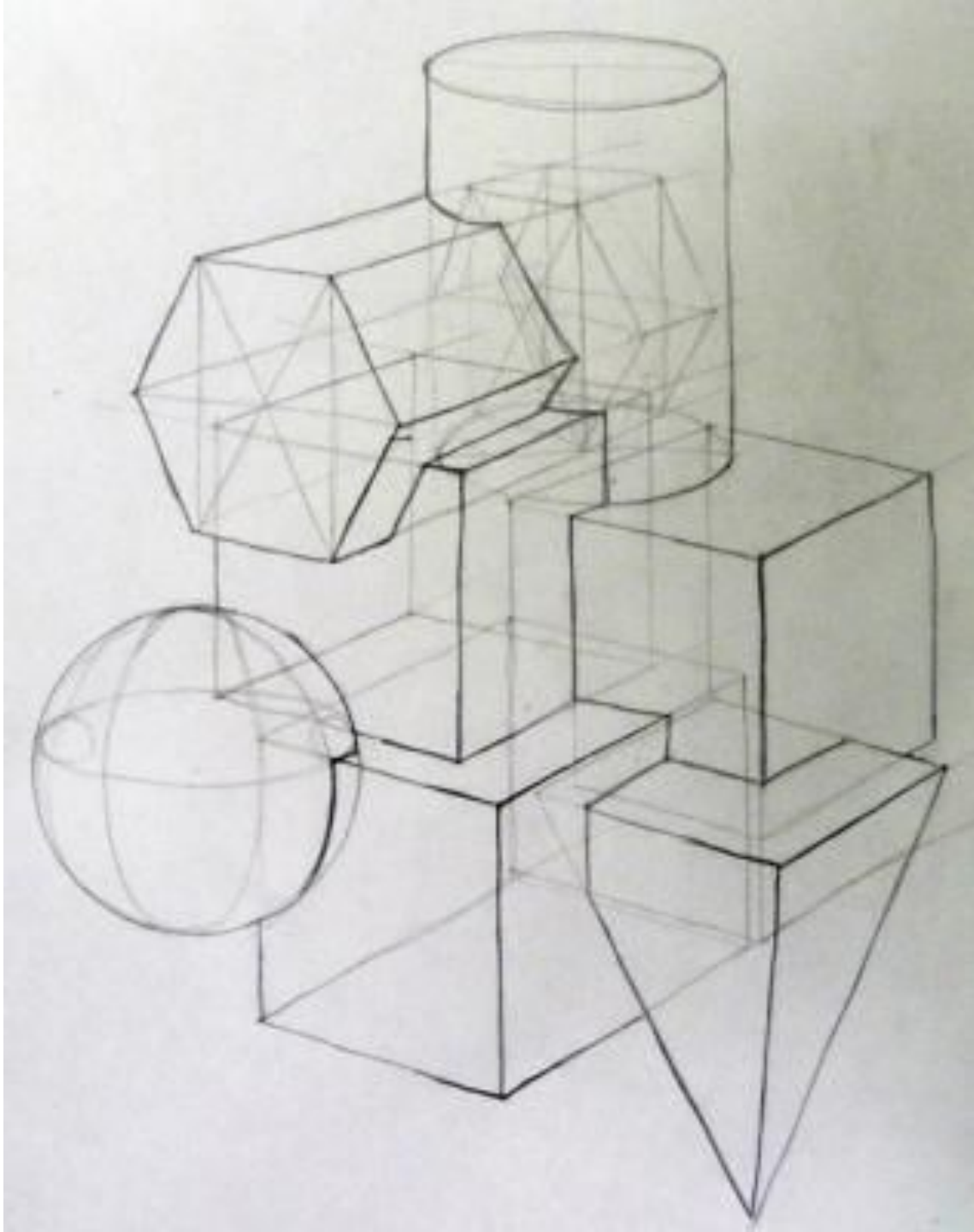

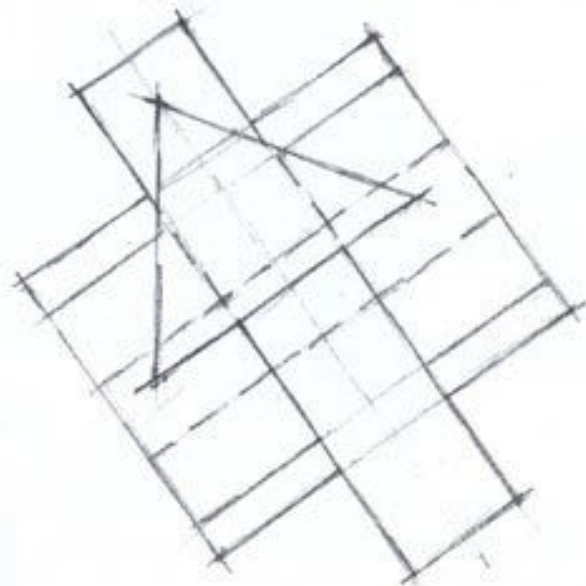
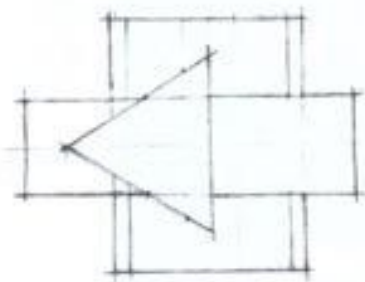
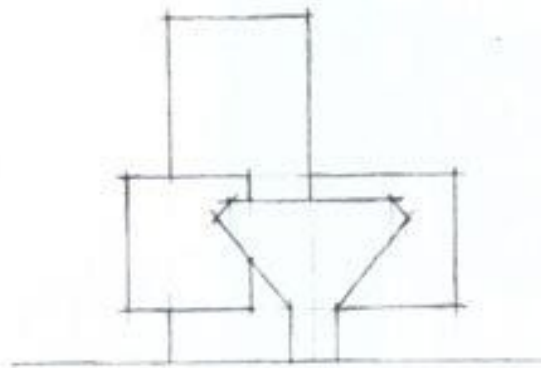
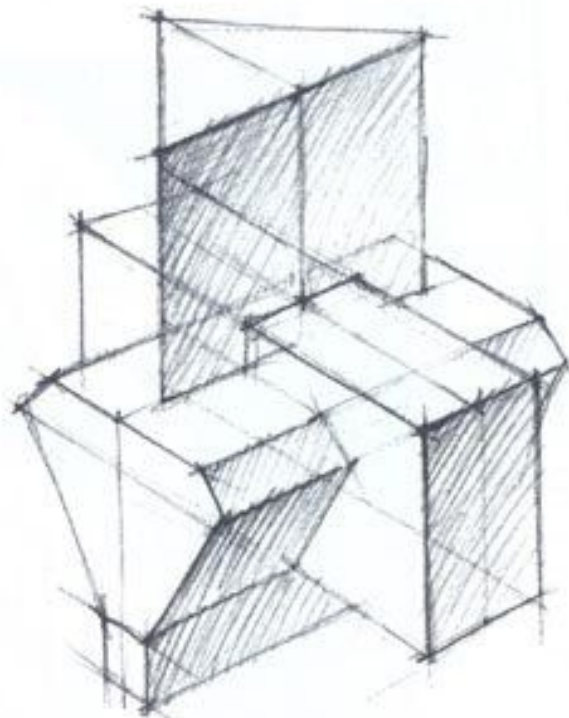
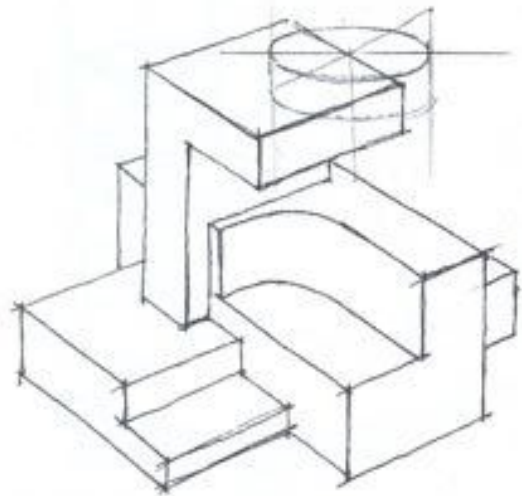

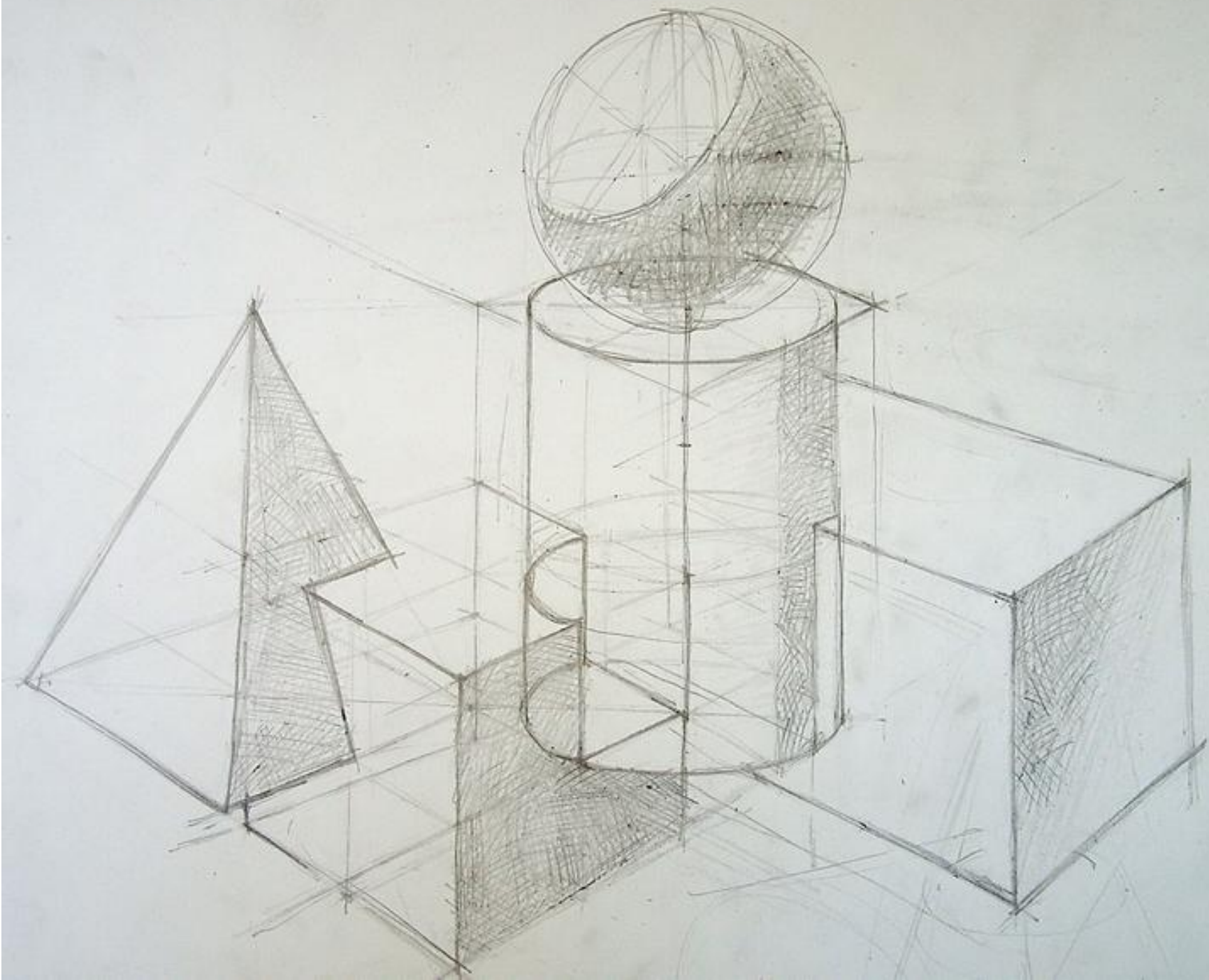

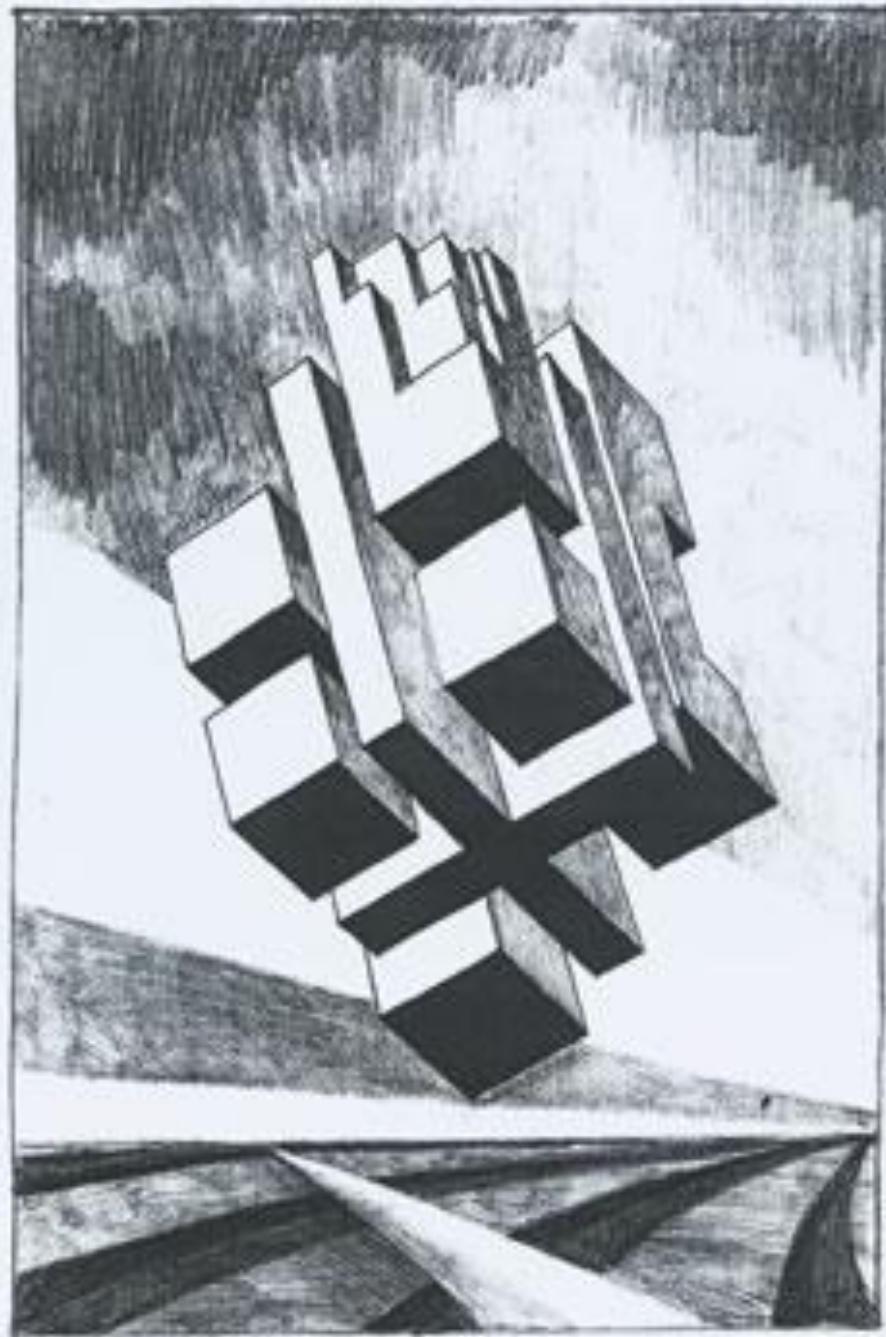

M. G. 19.12.10

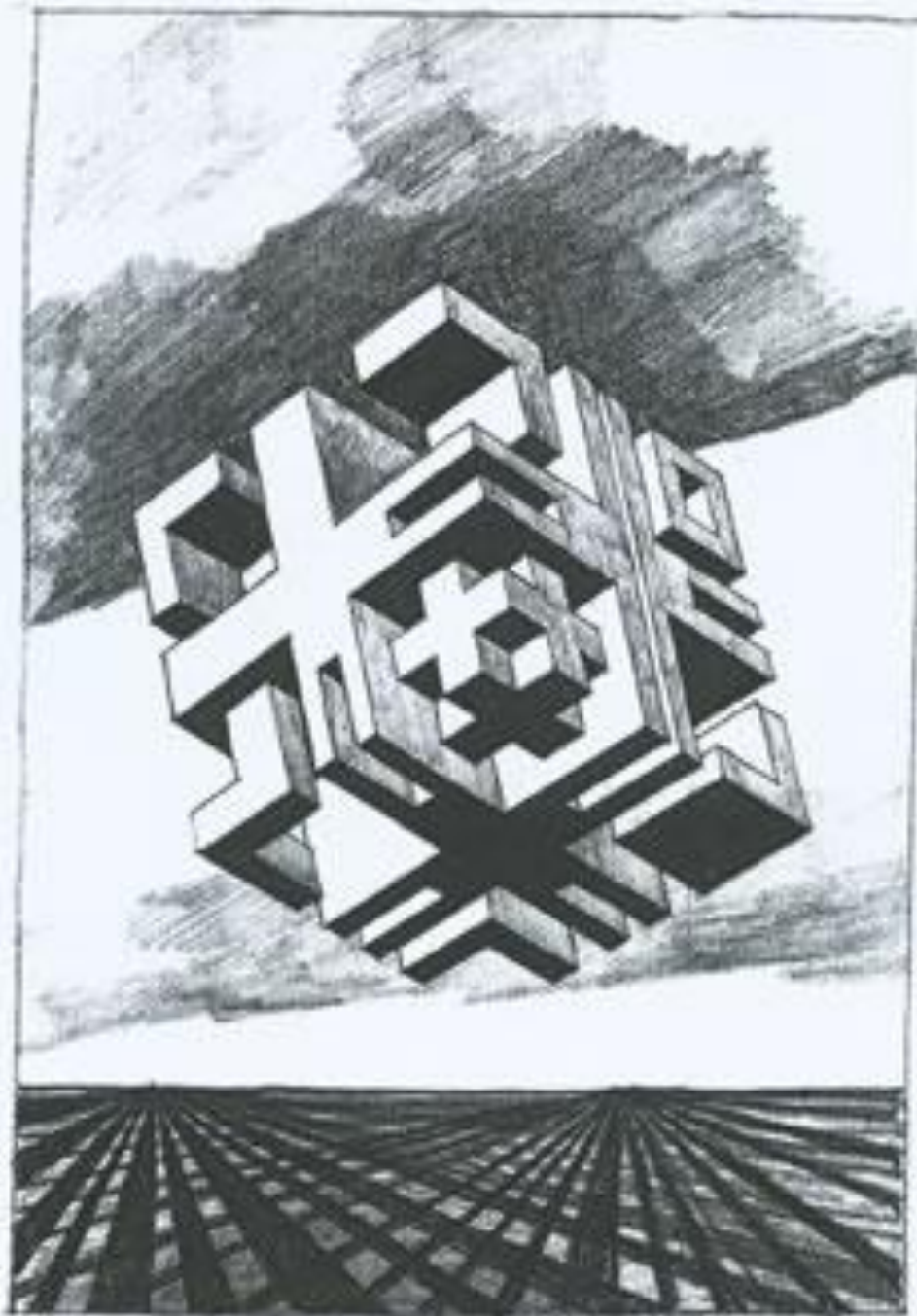

Phenomenon 19.12.70

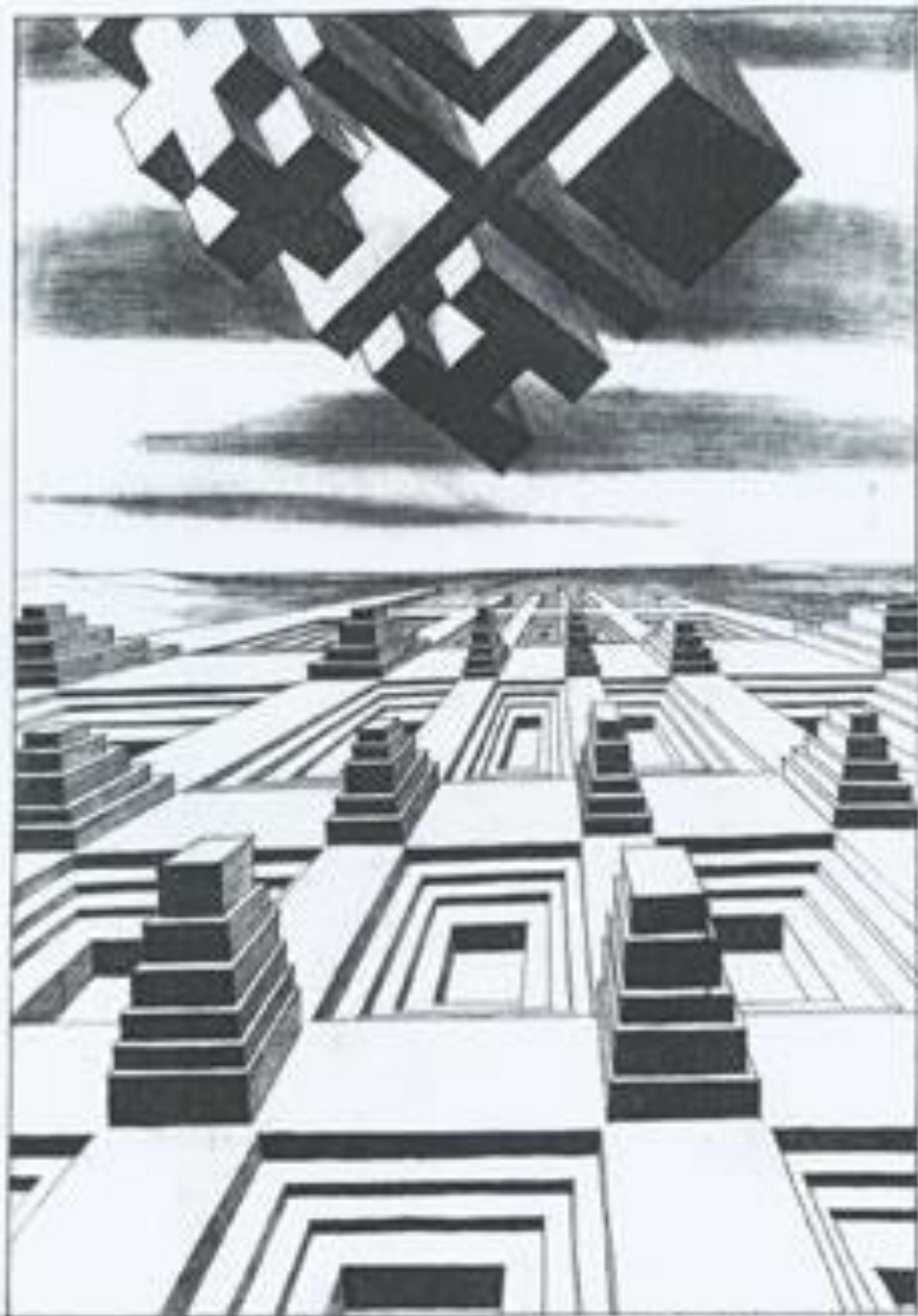

Escher 1927

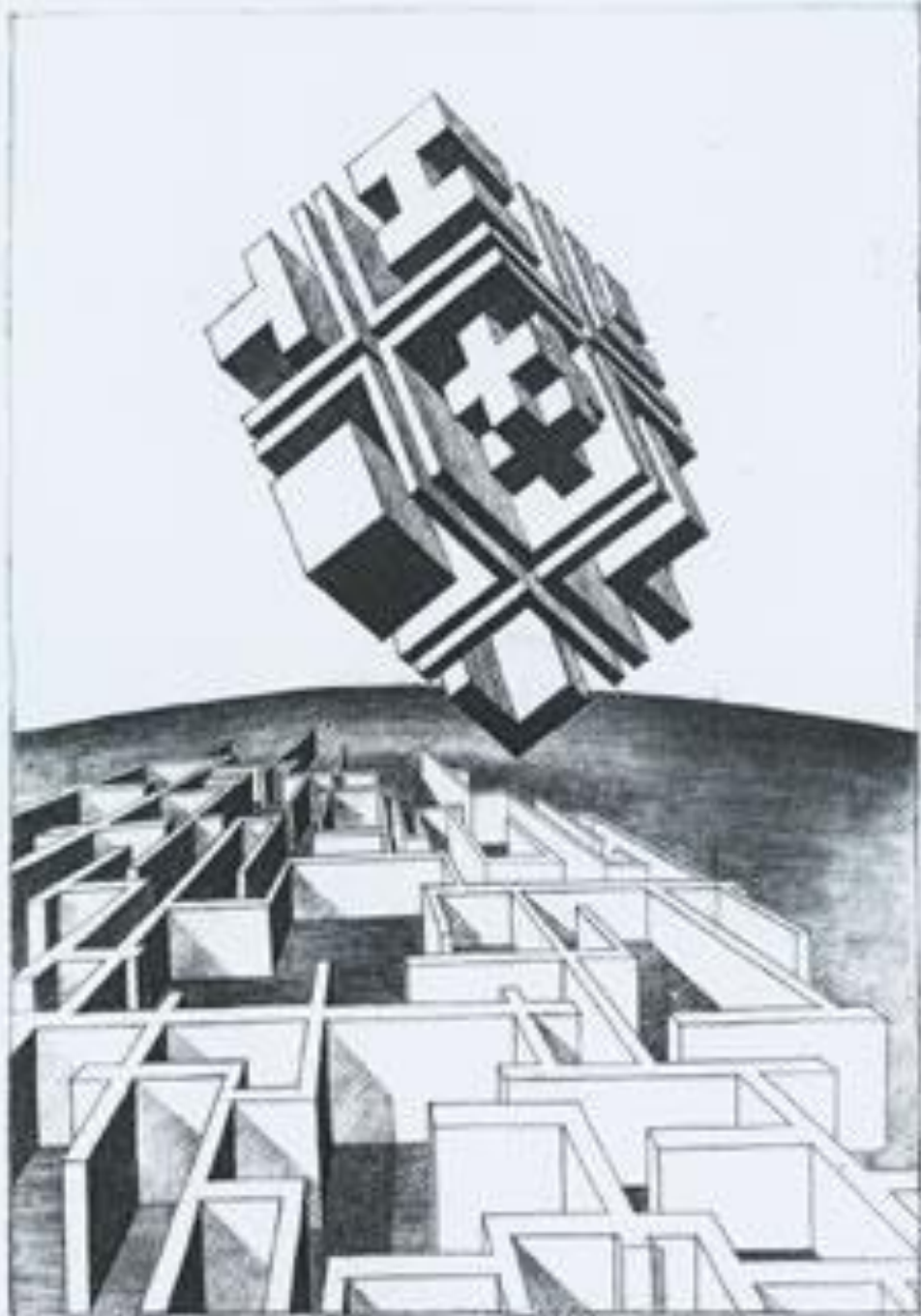

Handwritten signature and date: "Kiefer 1912.00"

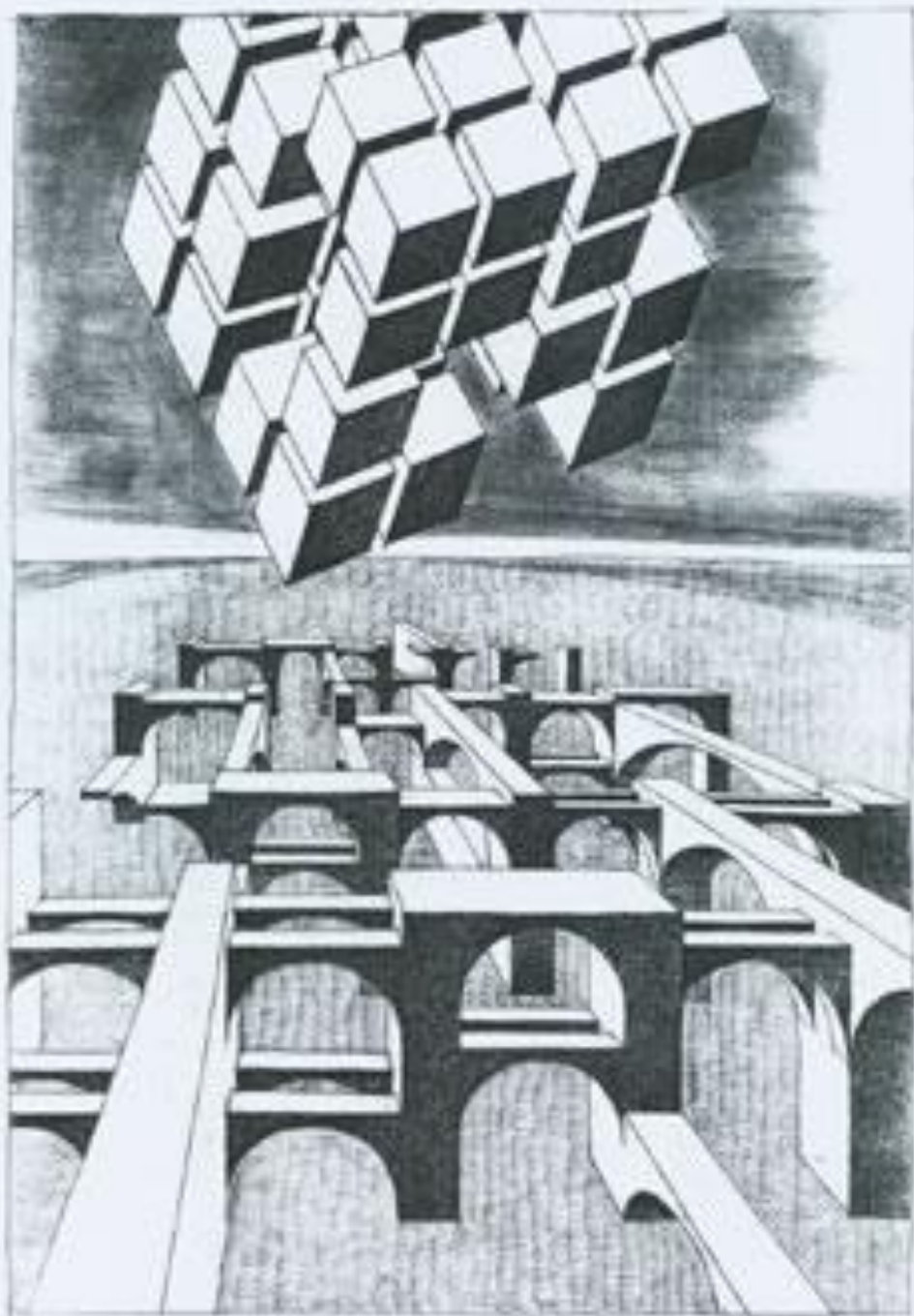

M.C. Escher 1928

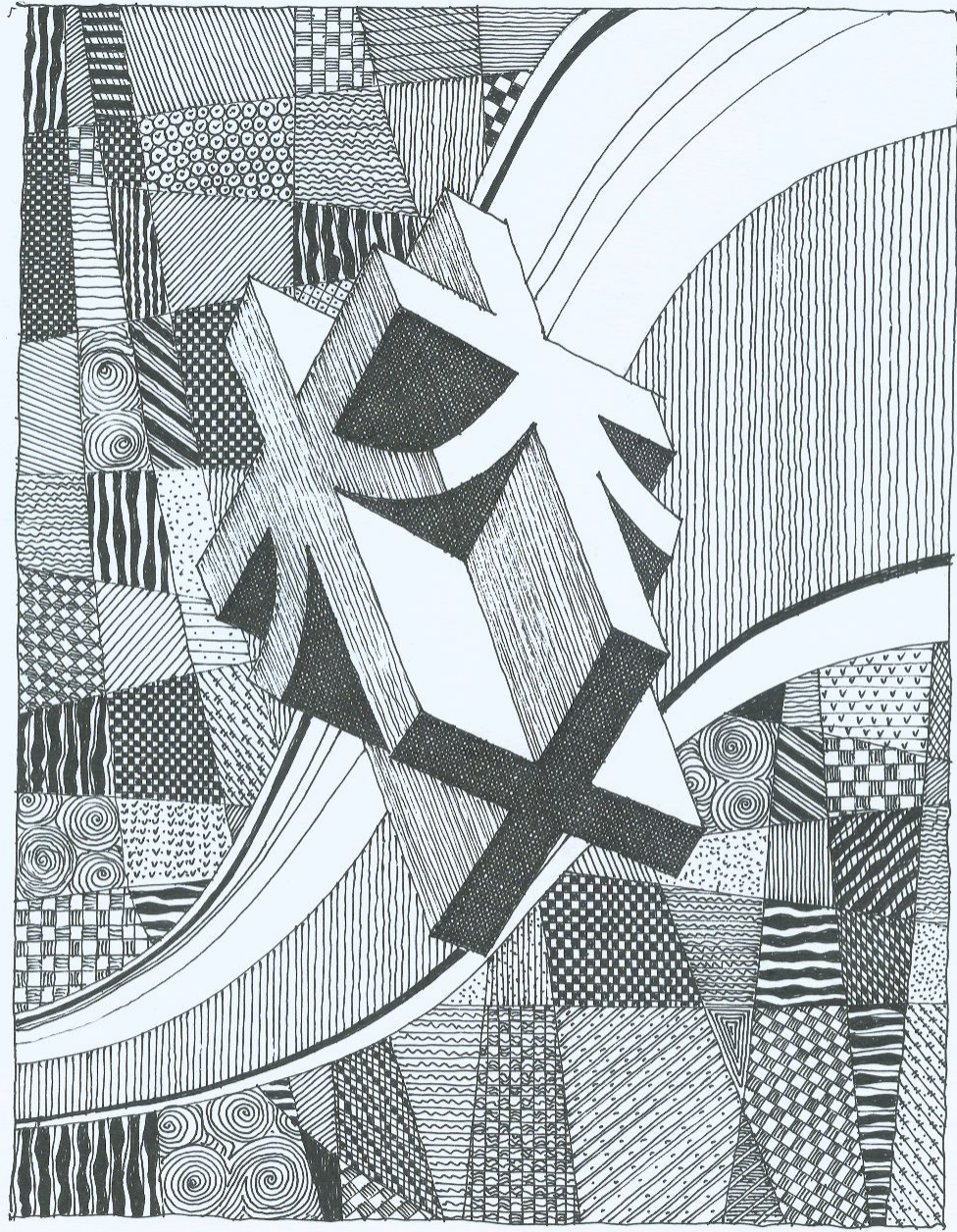

Albera
Albera 22.08.02

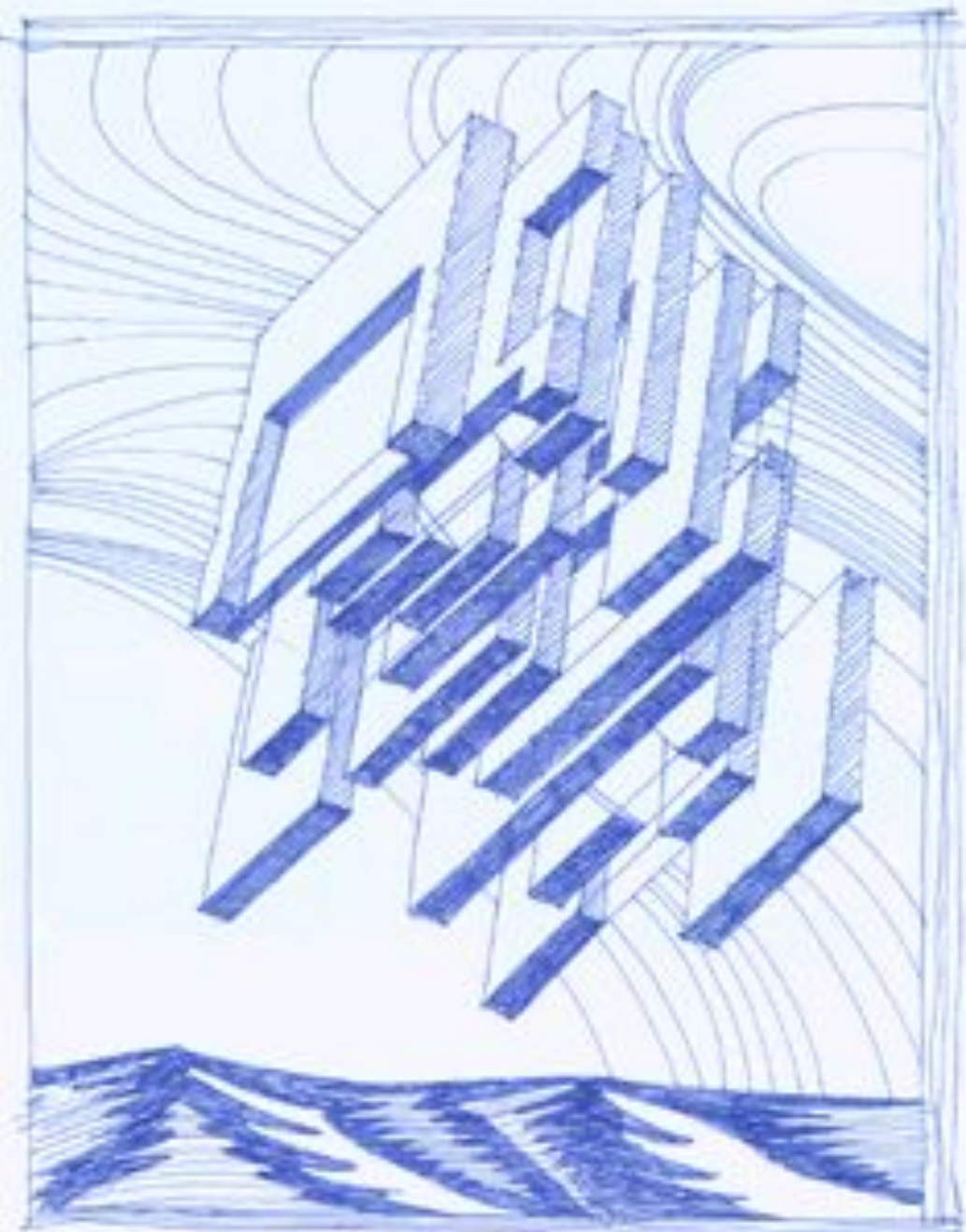

Handwritten signature and date: 19.12.01. 2006

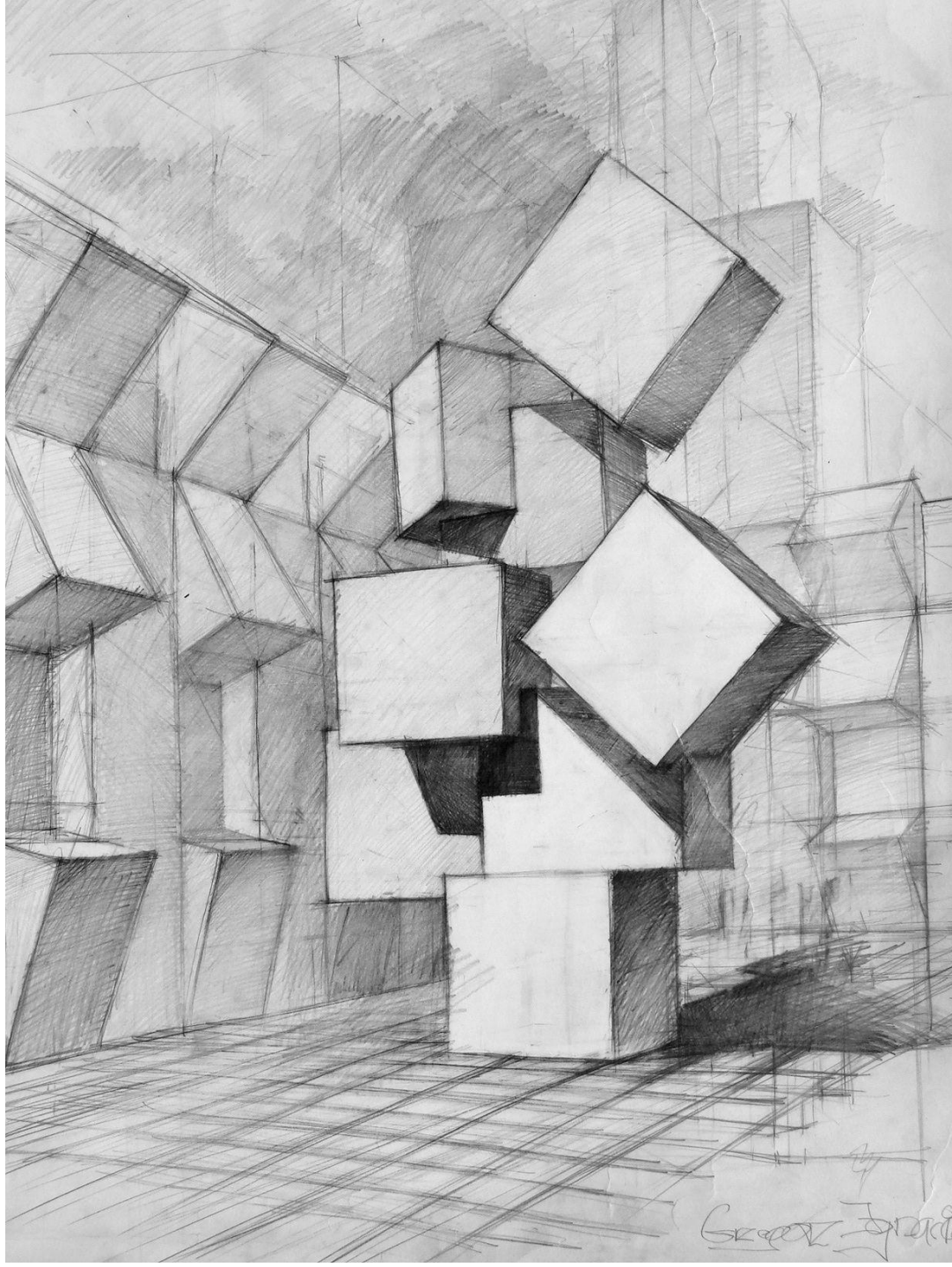

George J. ...

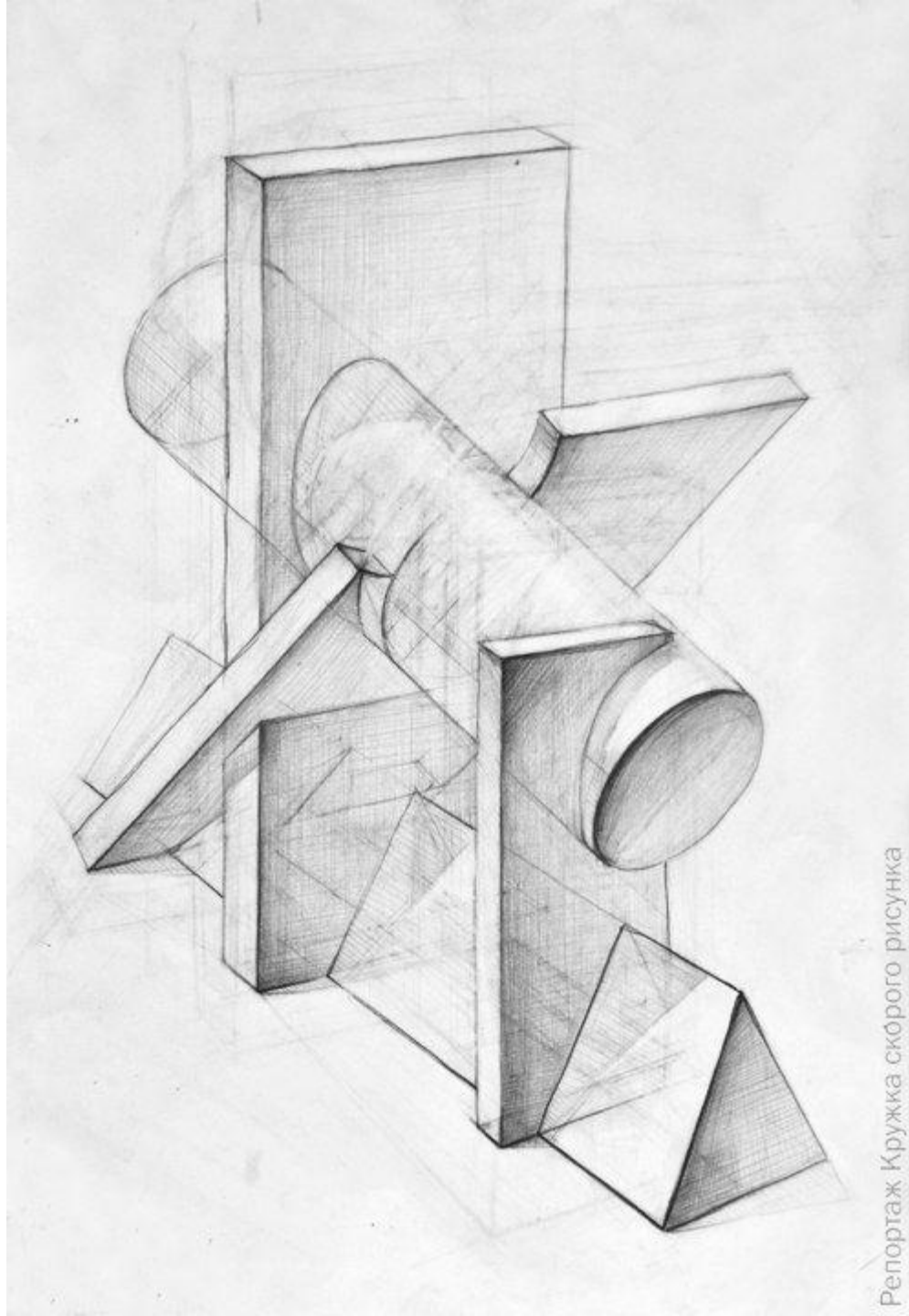

Репортаж Кружка скорого рисунка

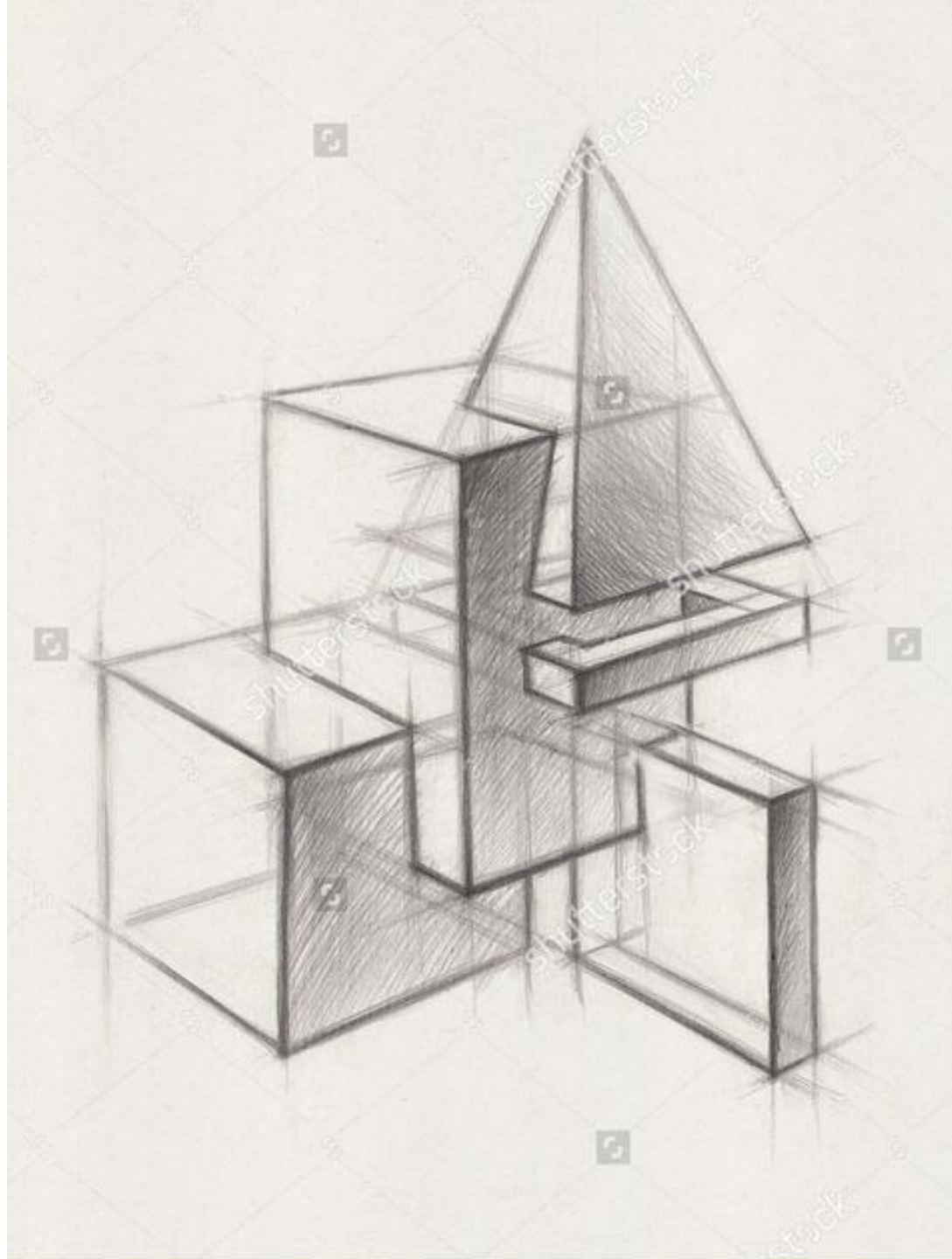

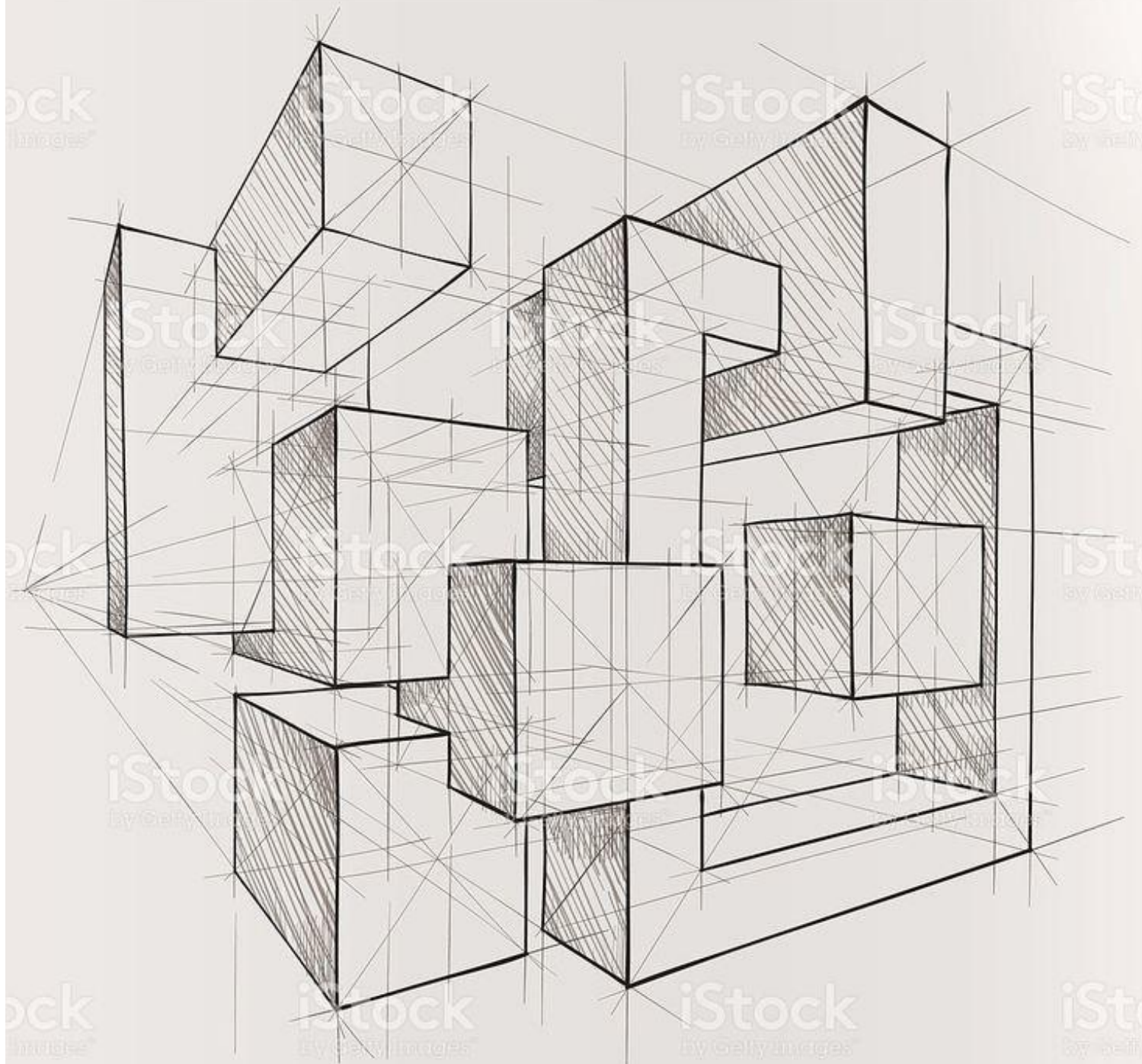

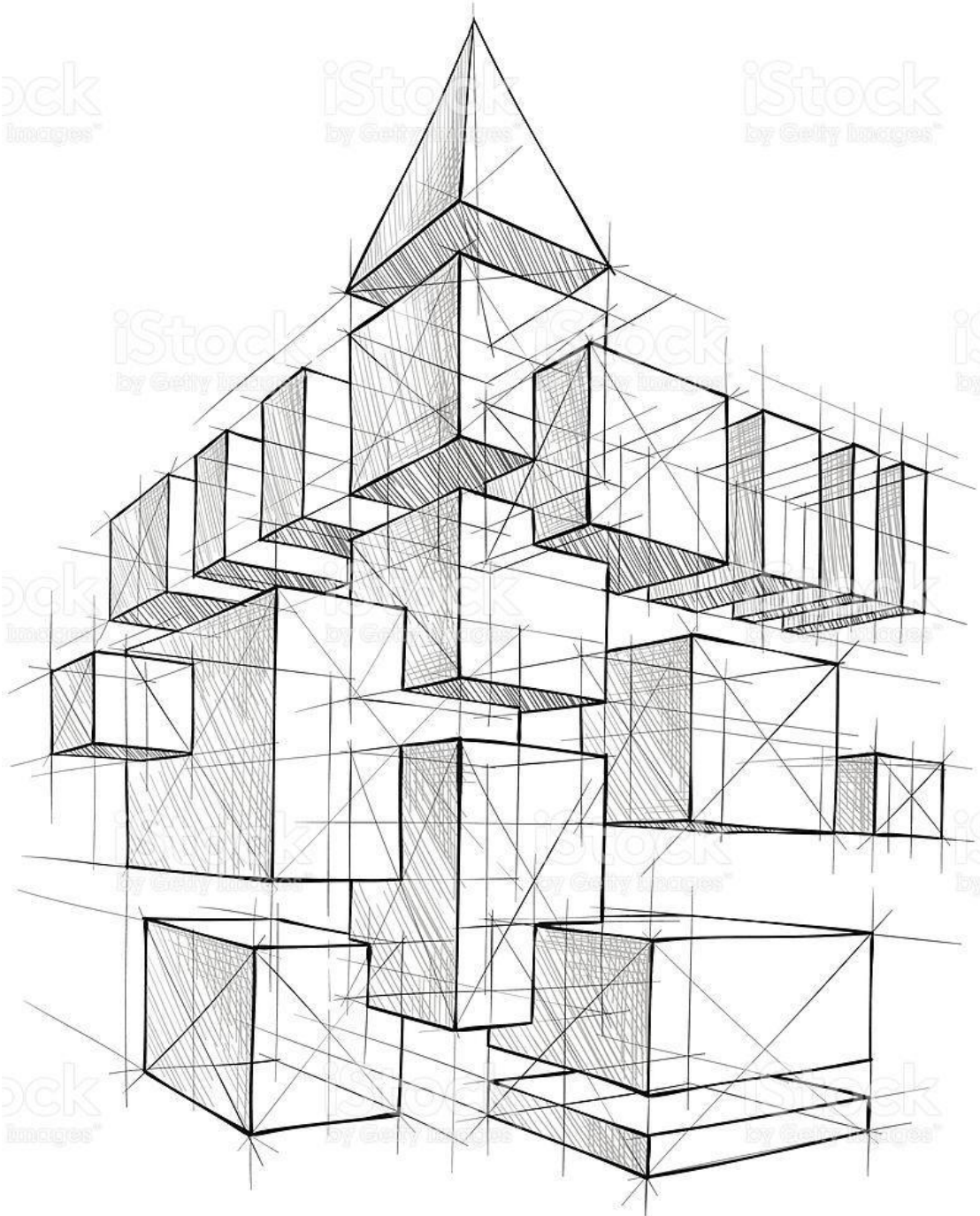

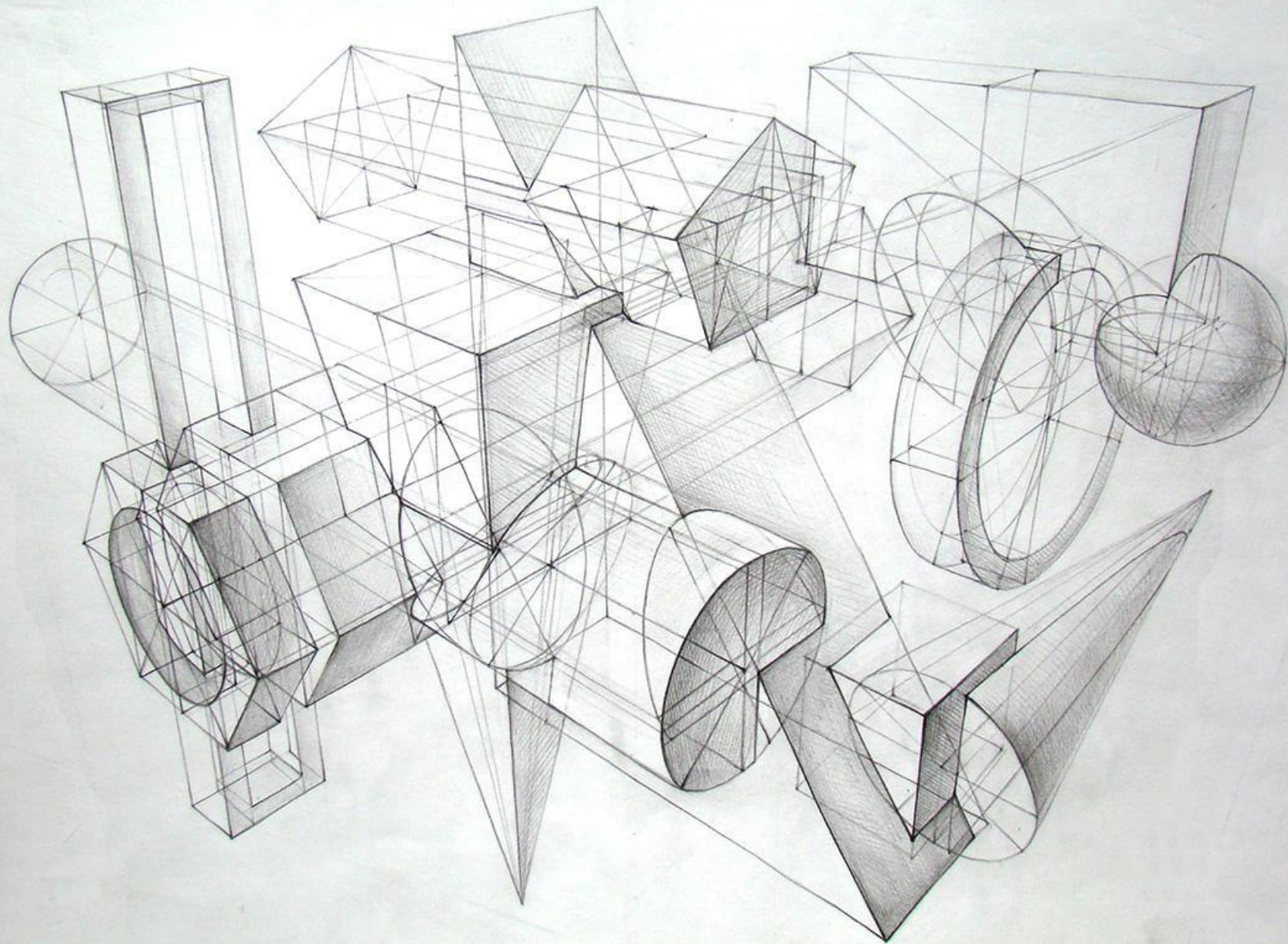

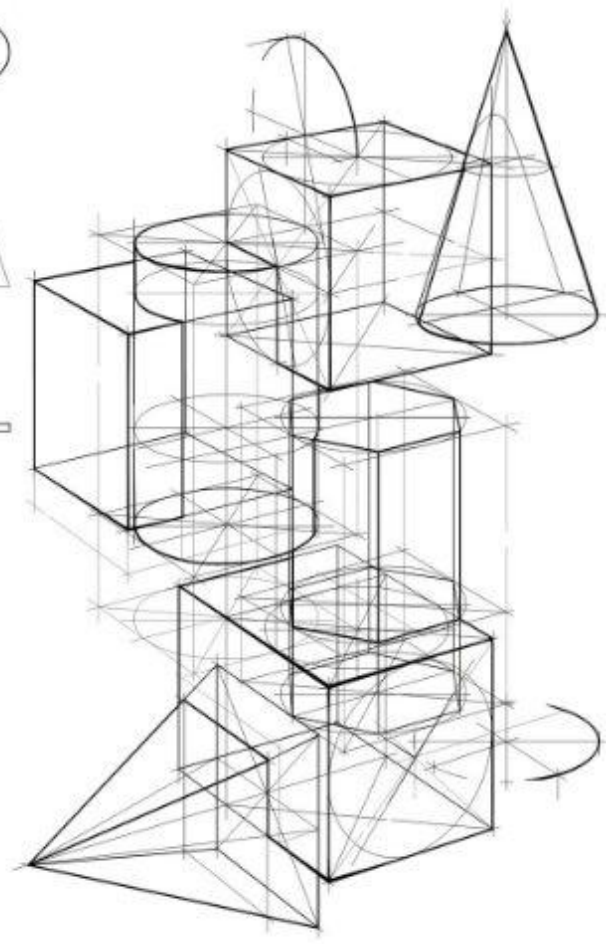
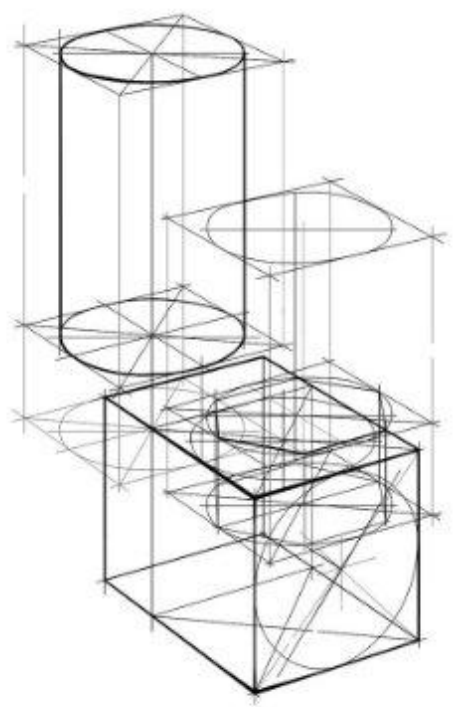
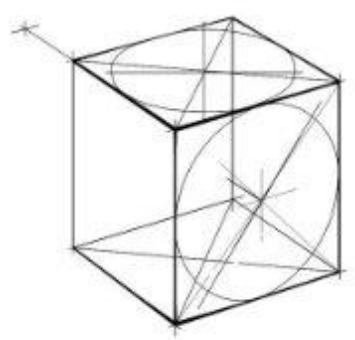
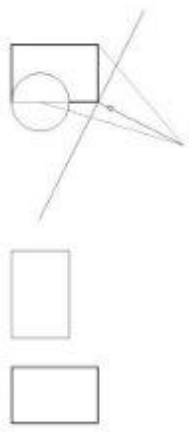

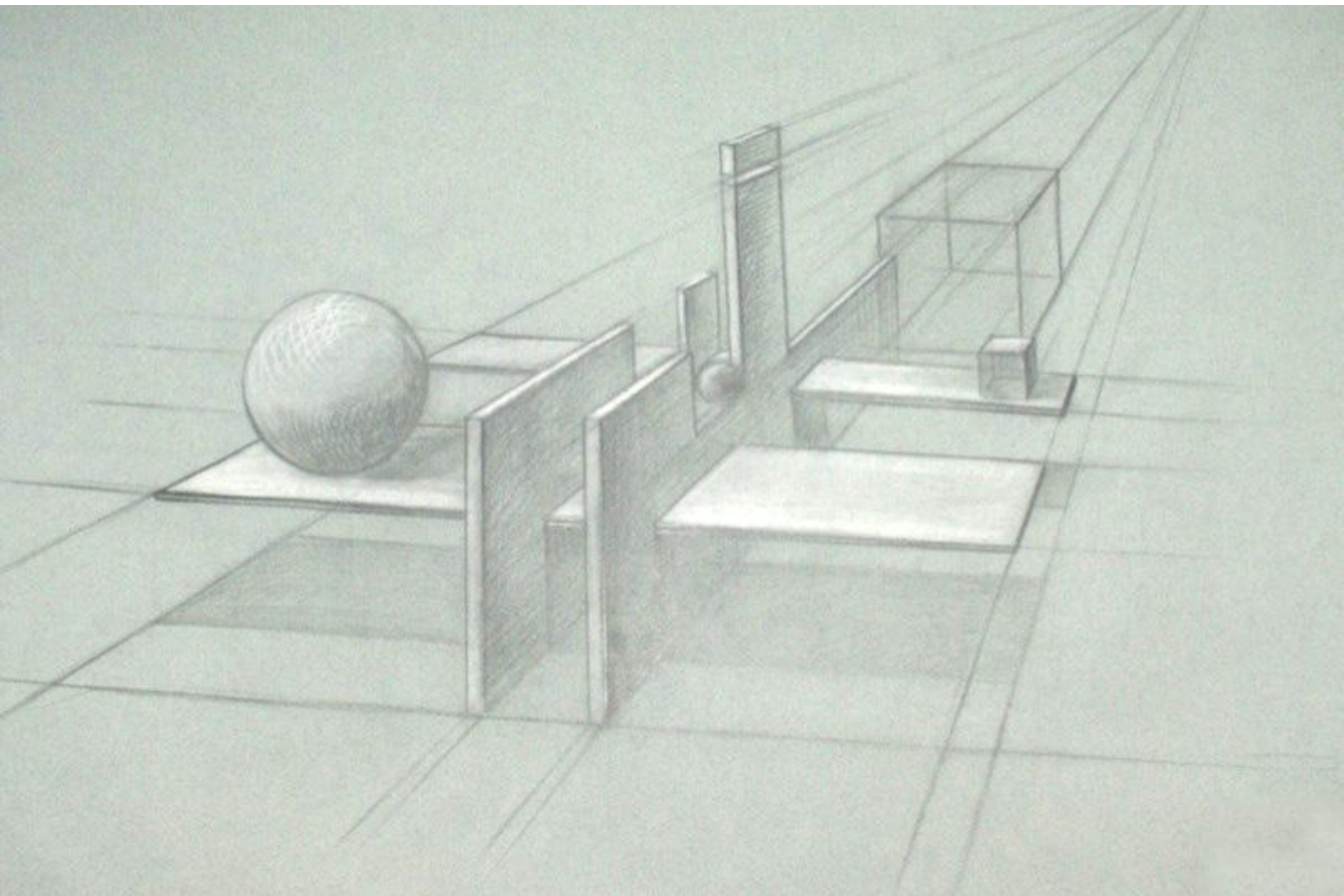

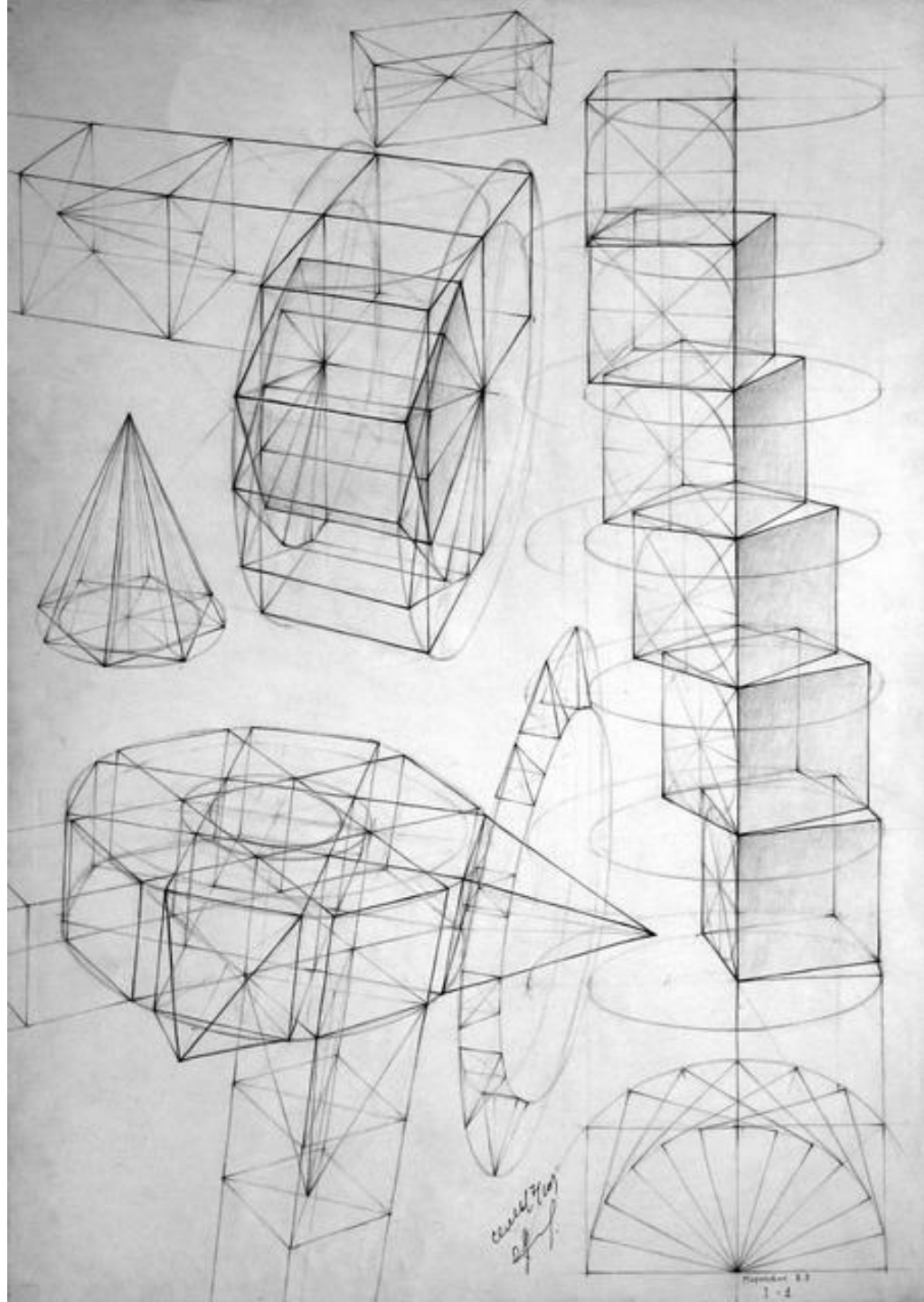

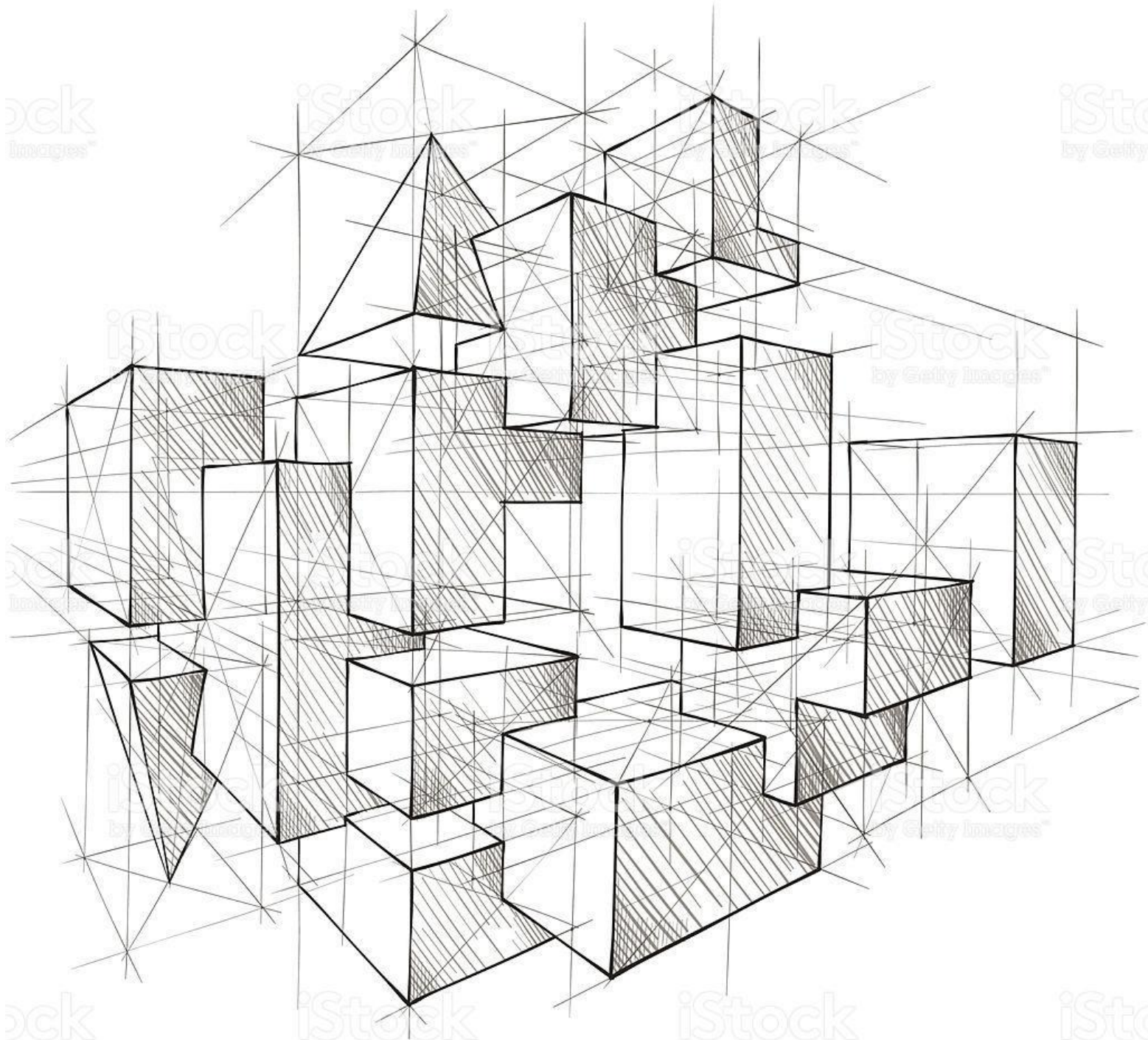

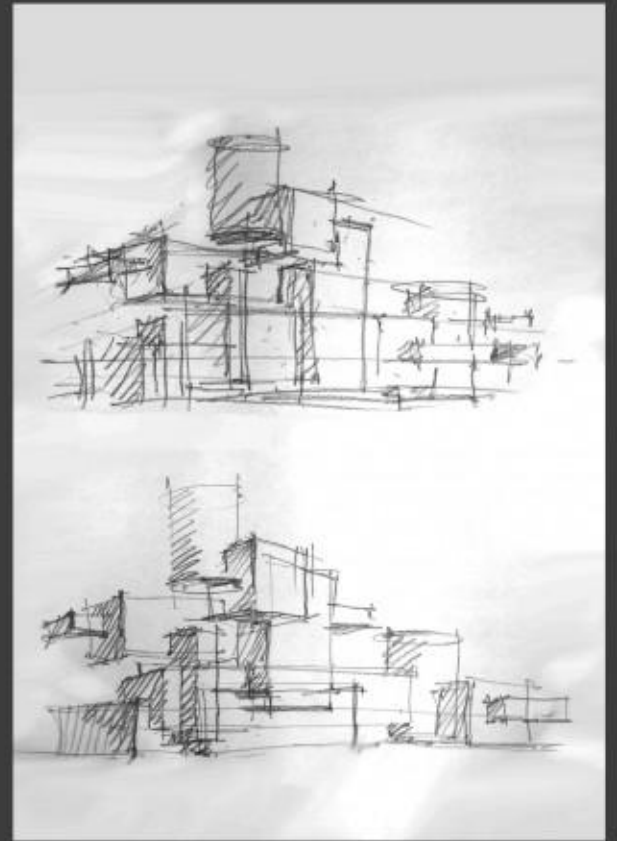
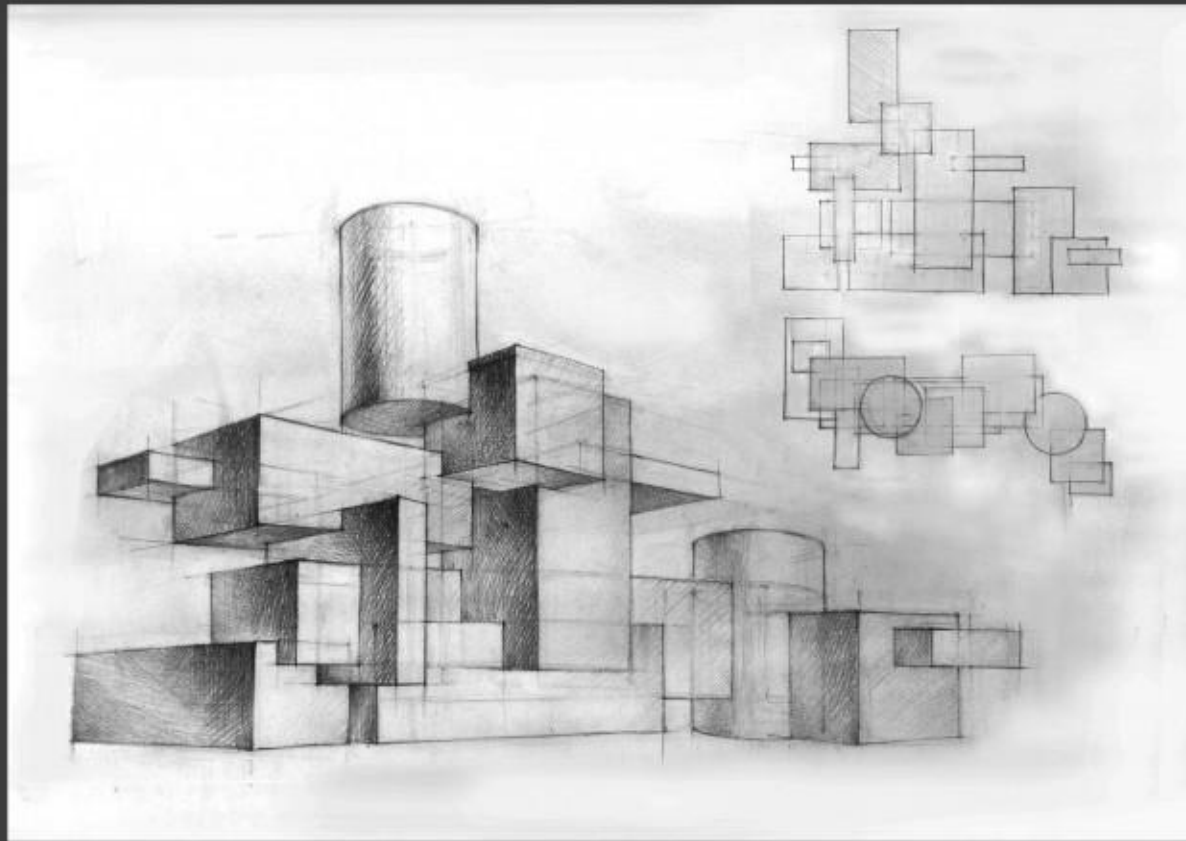

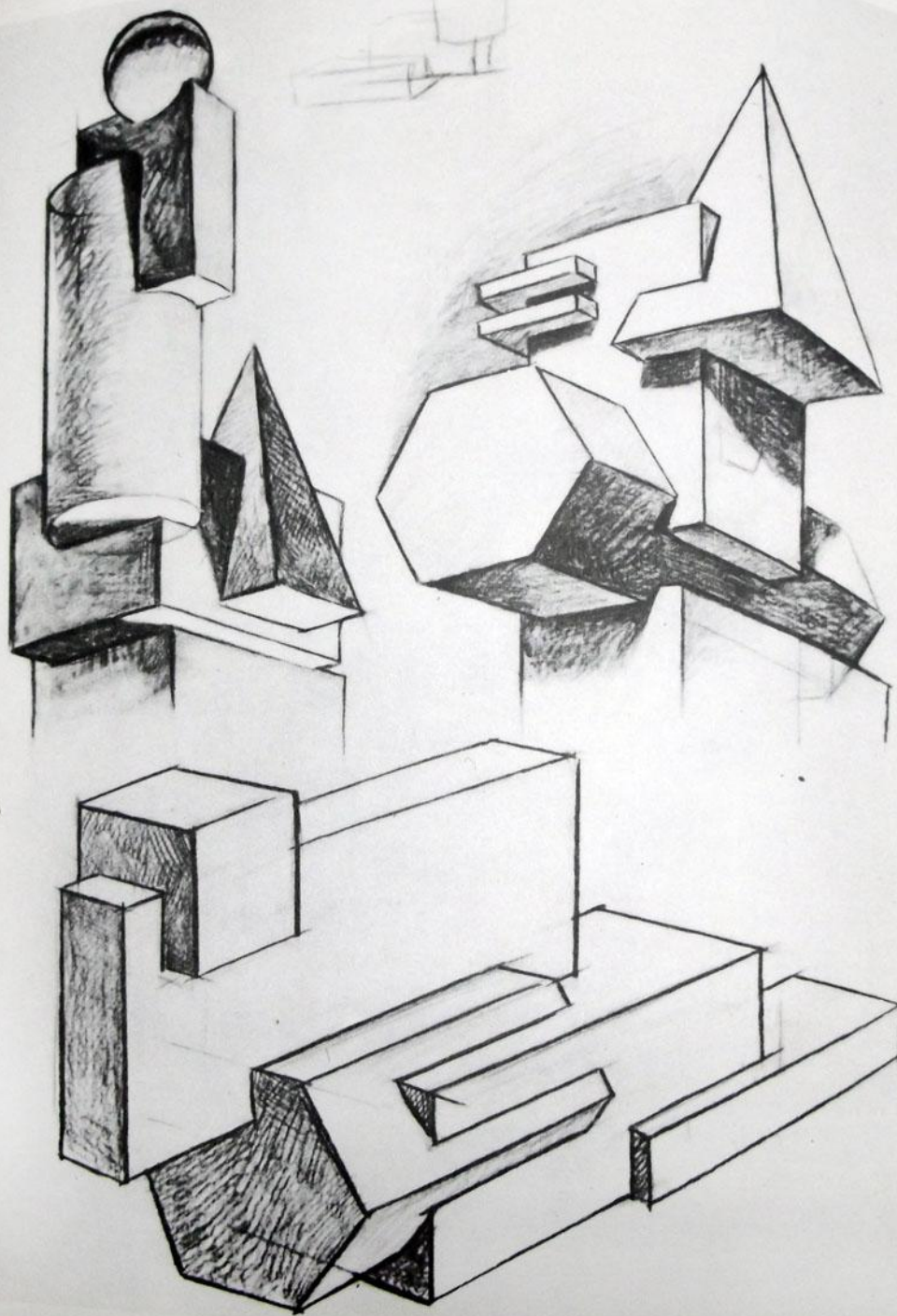

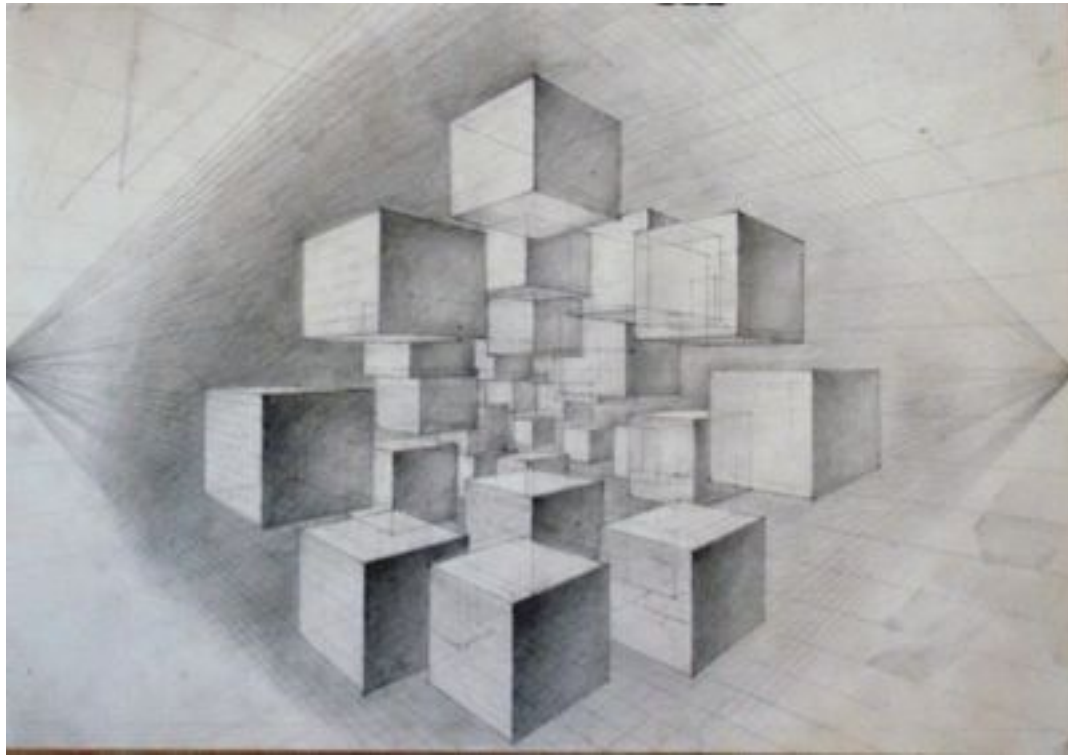

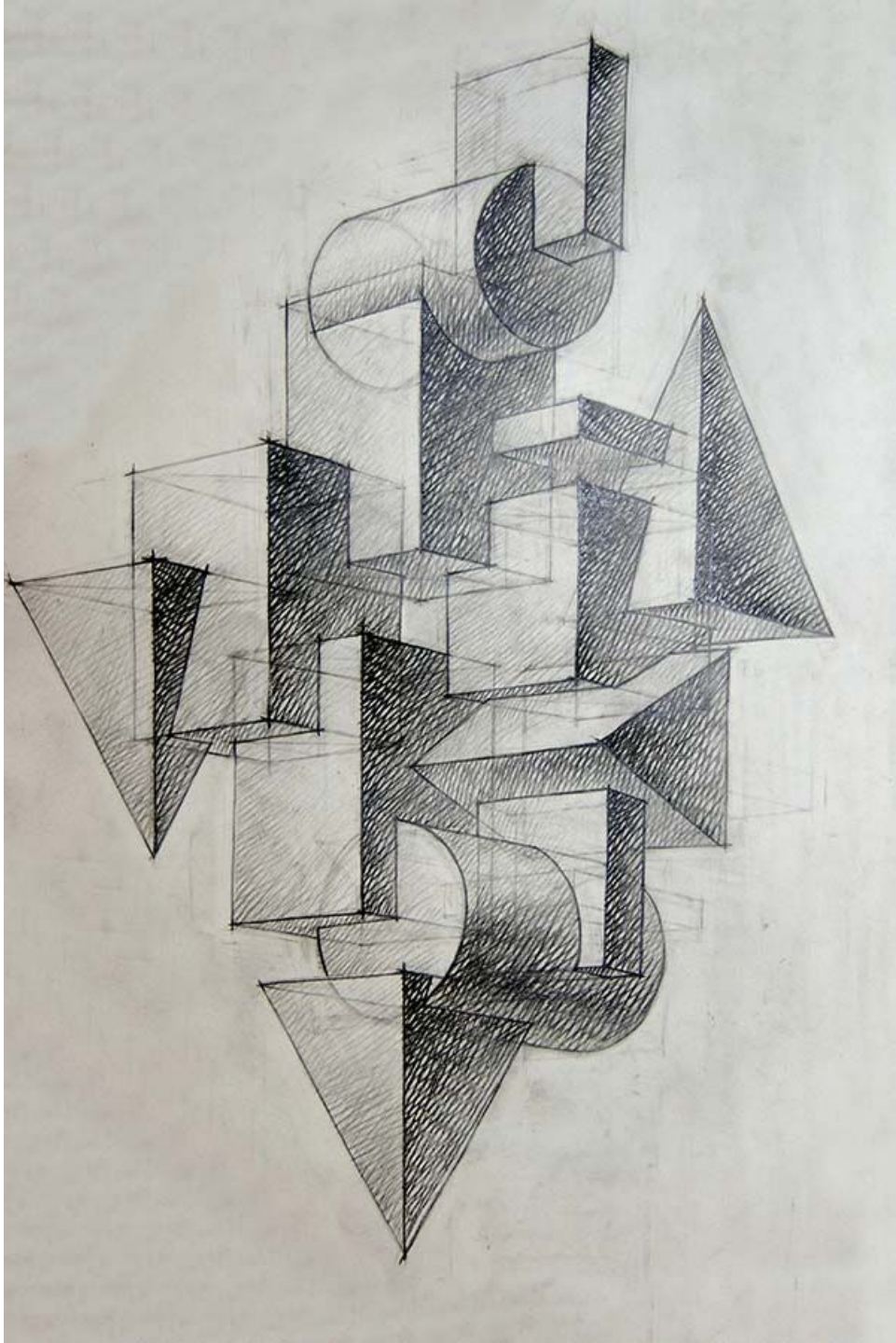

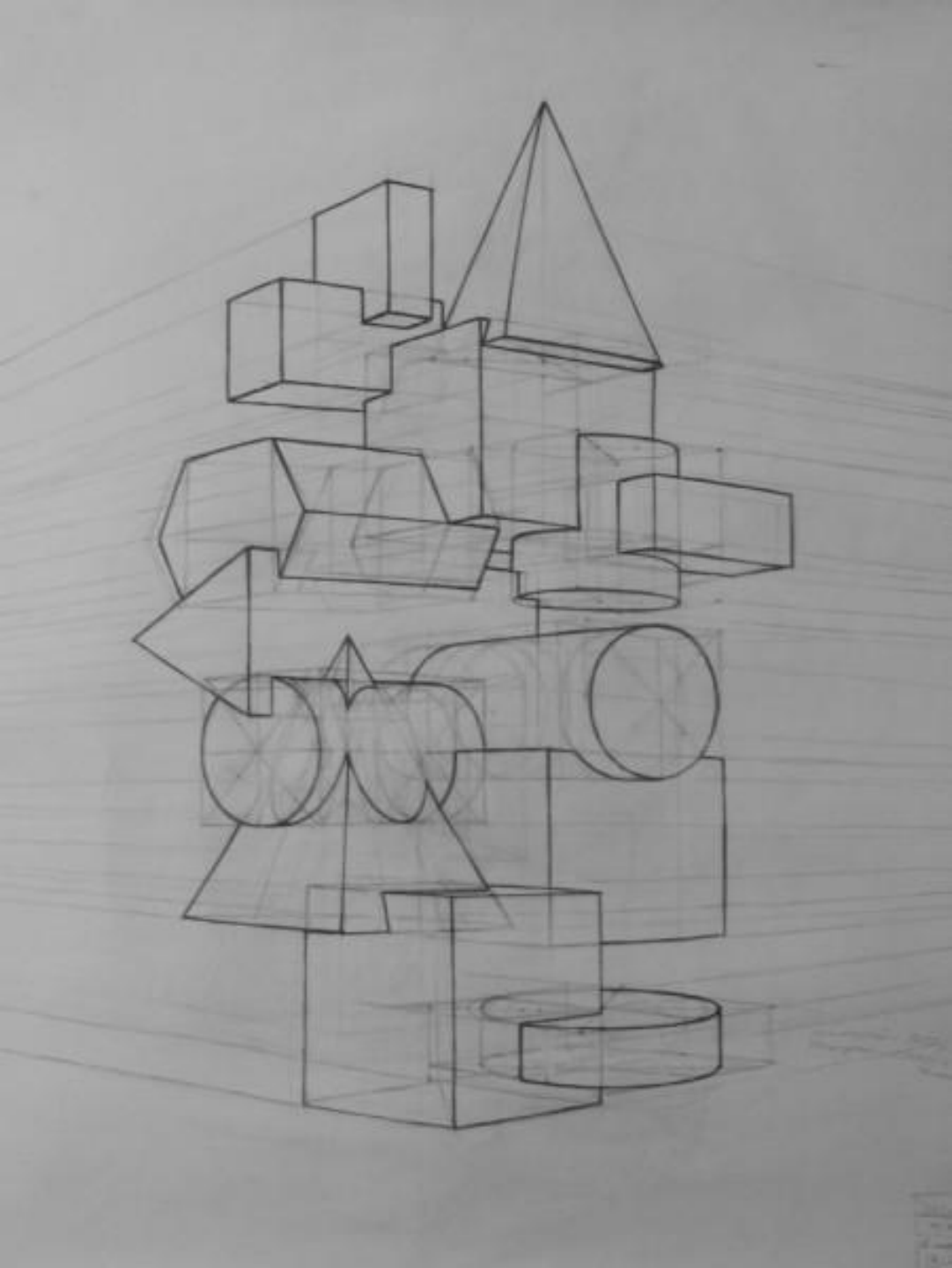

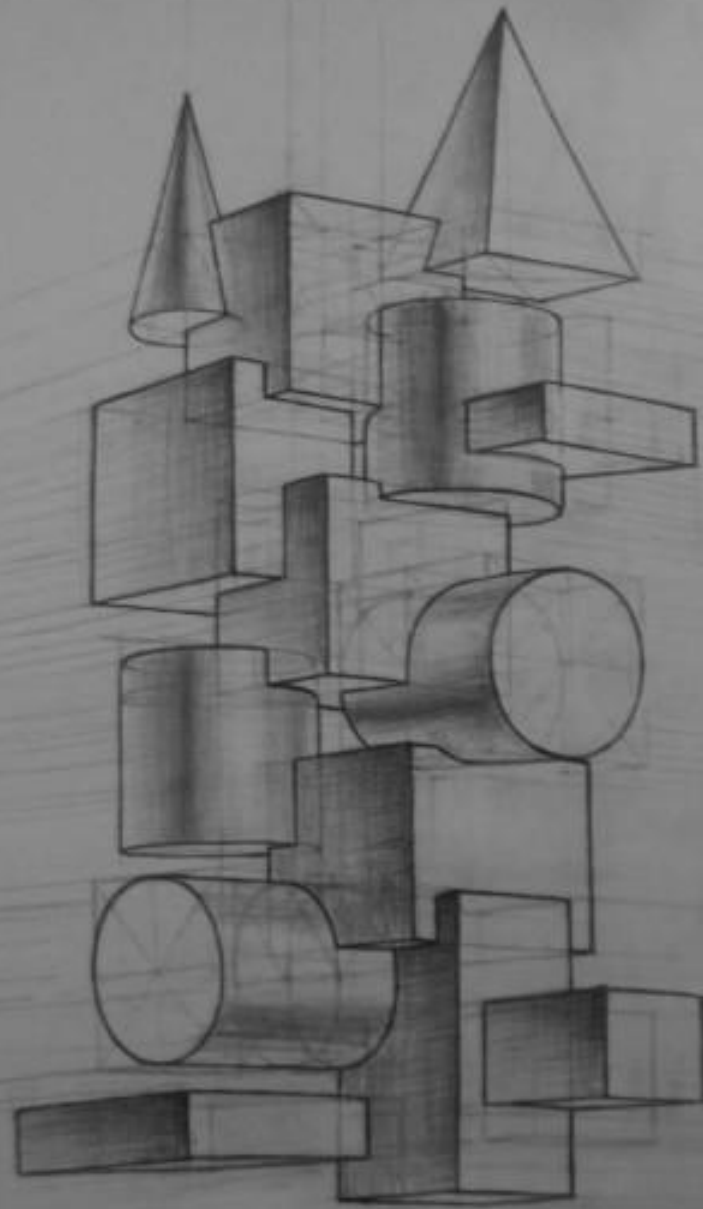

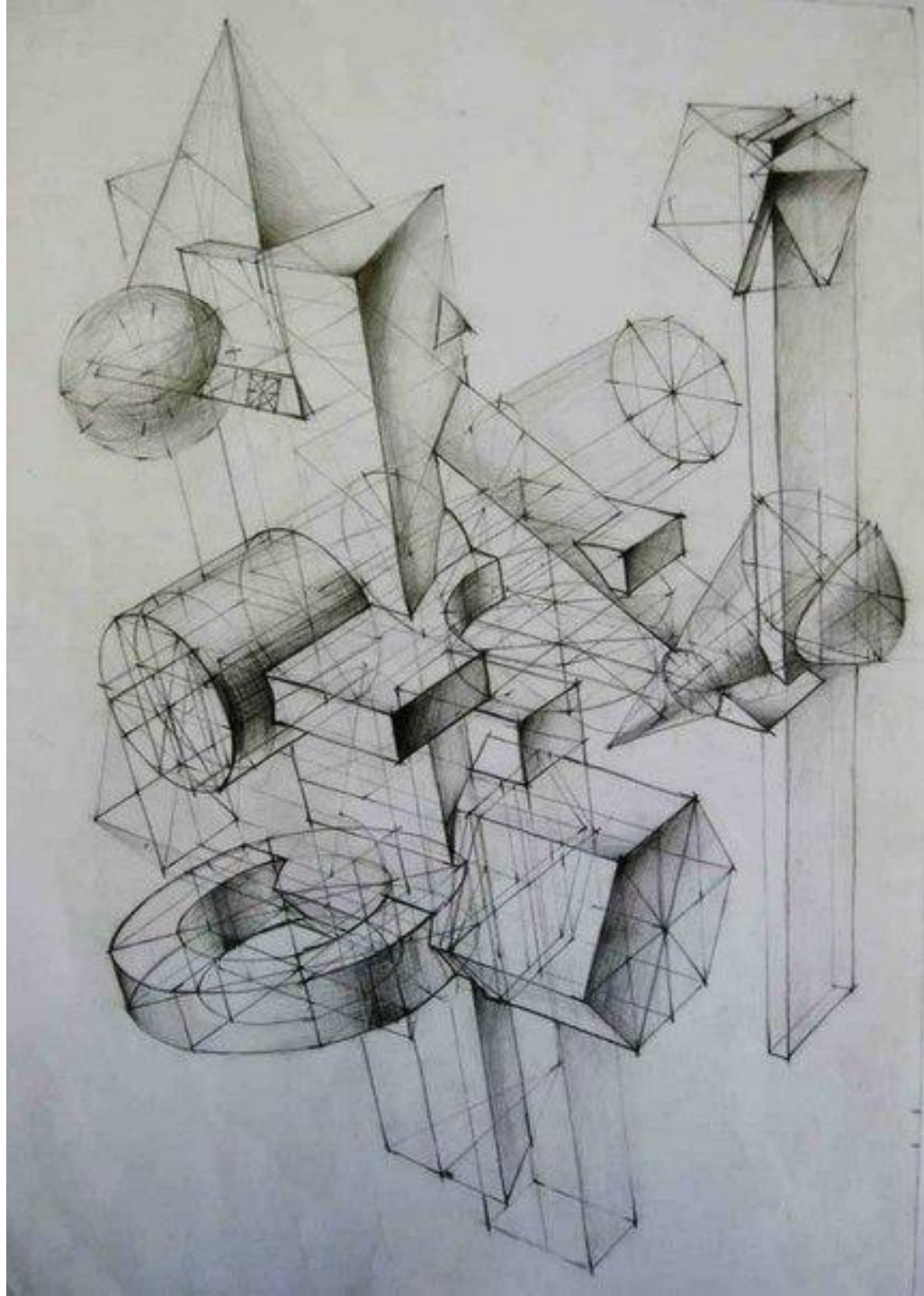

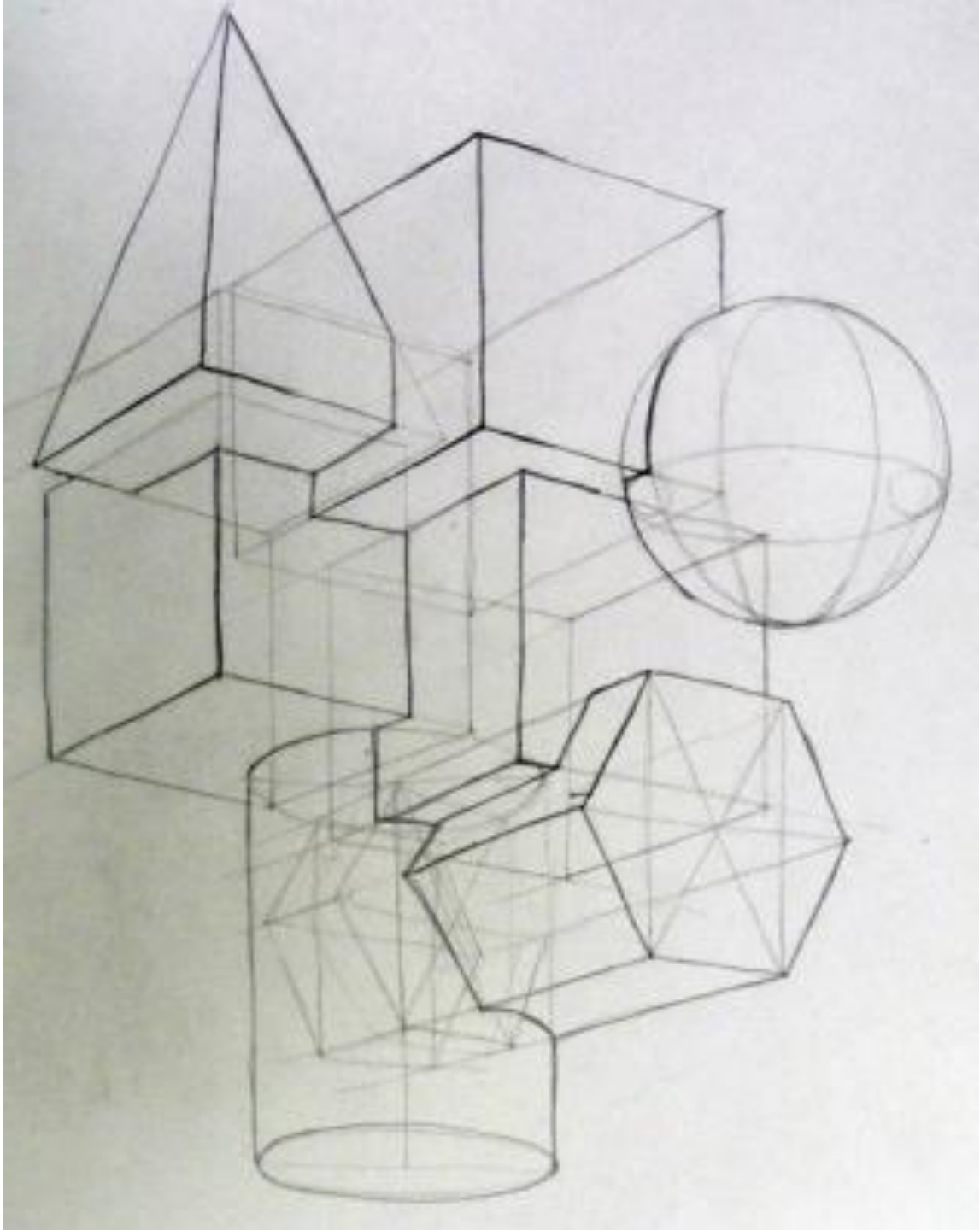

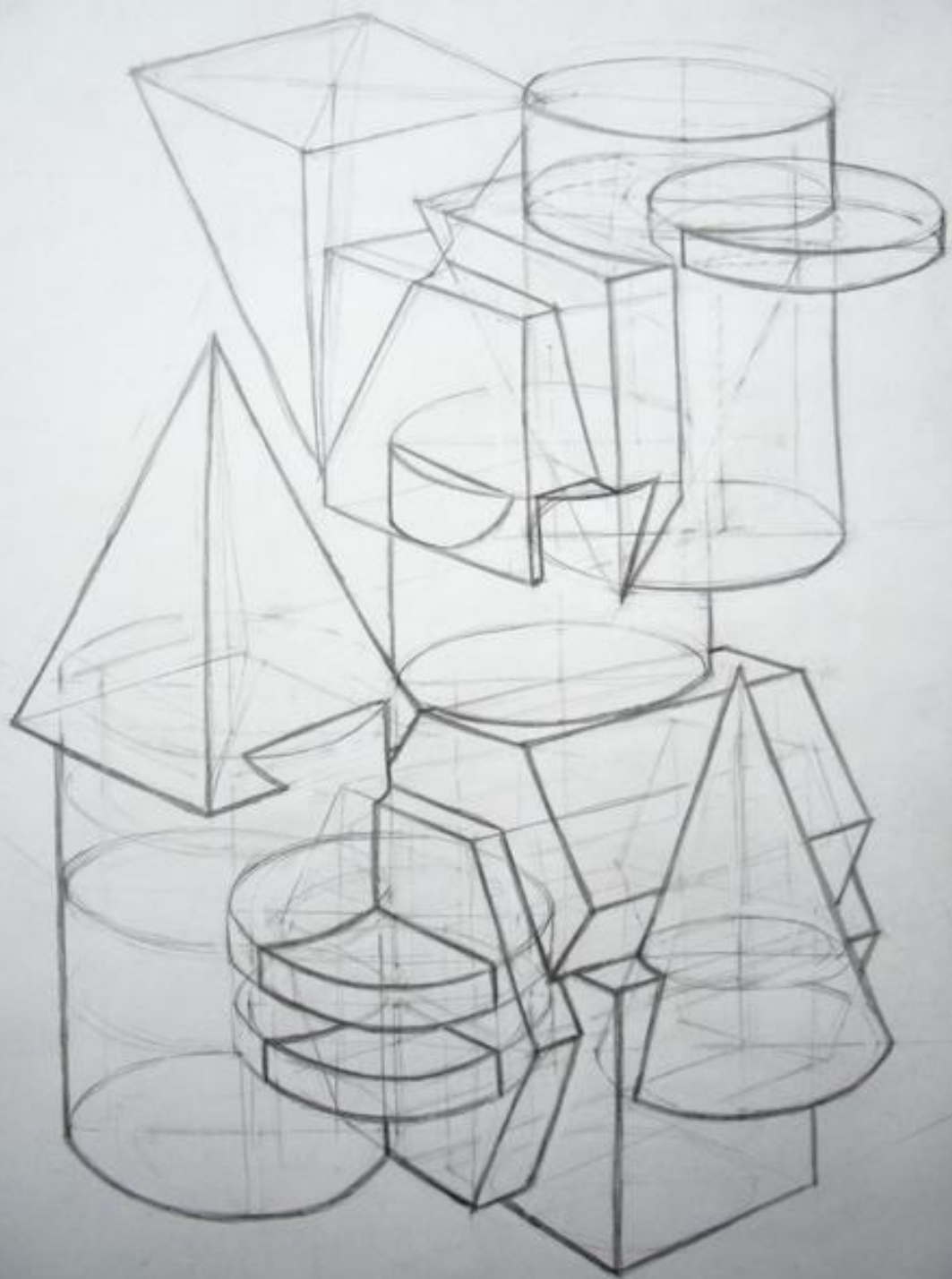

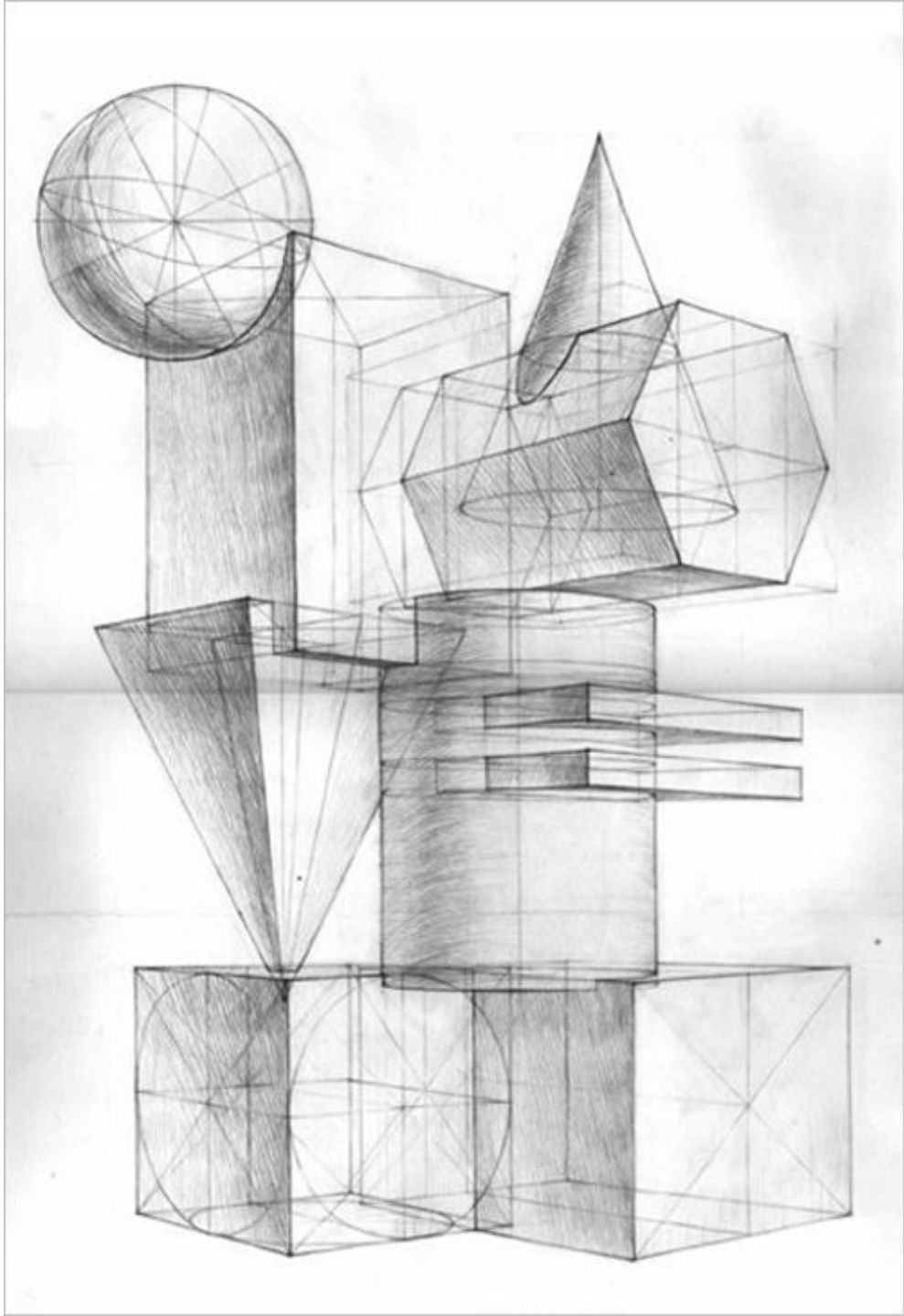

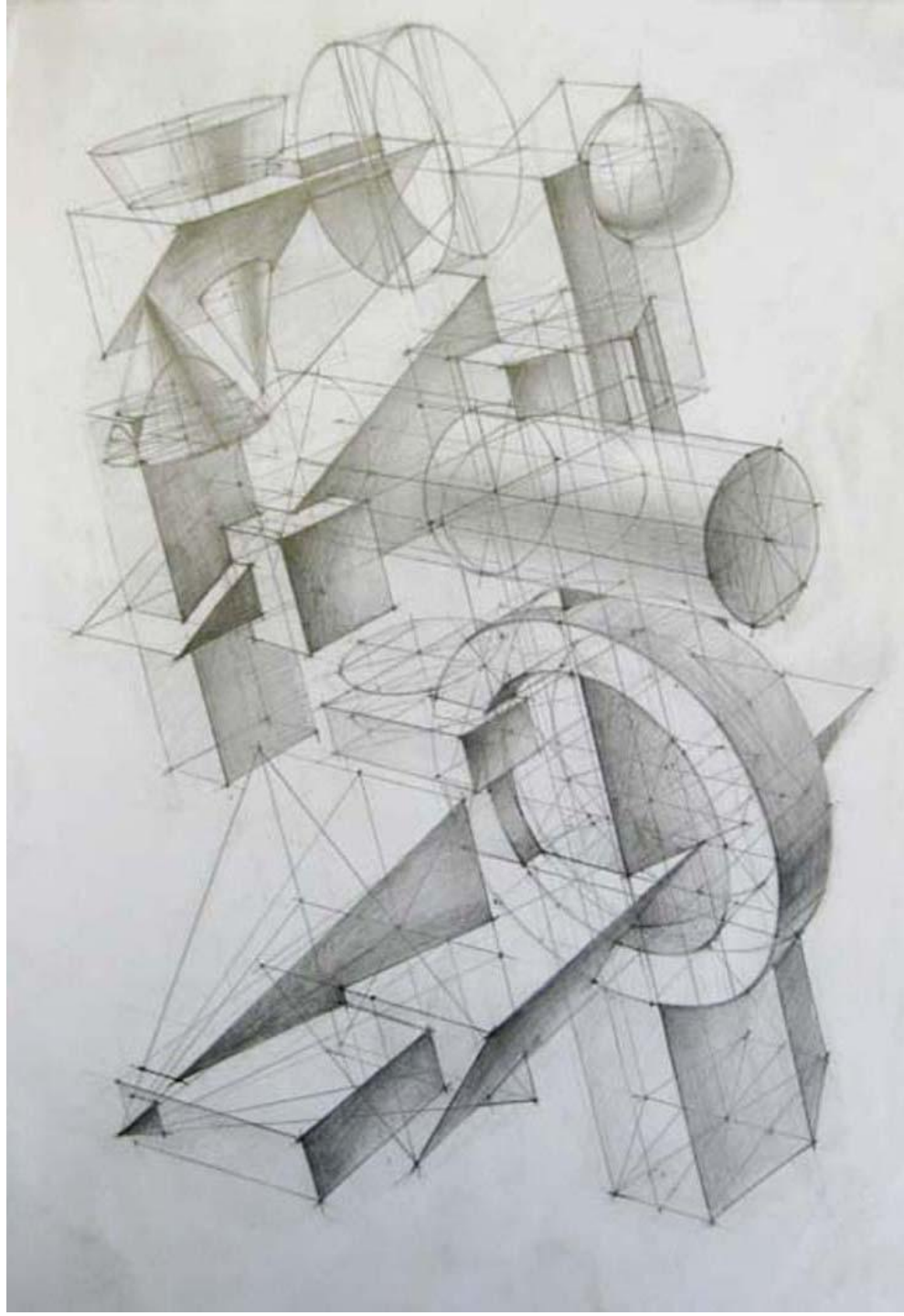

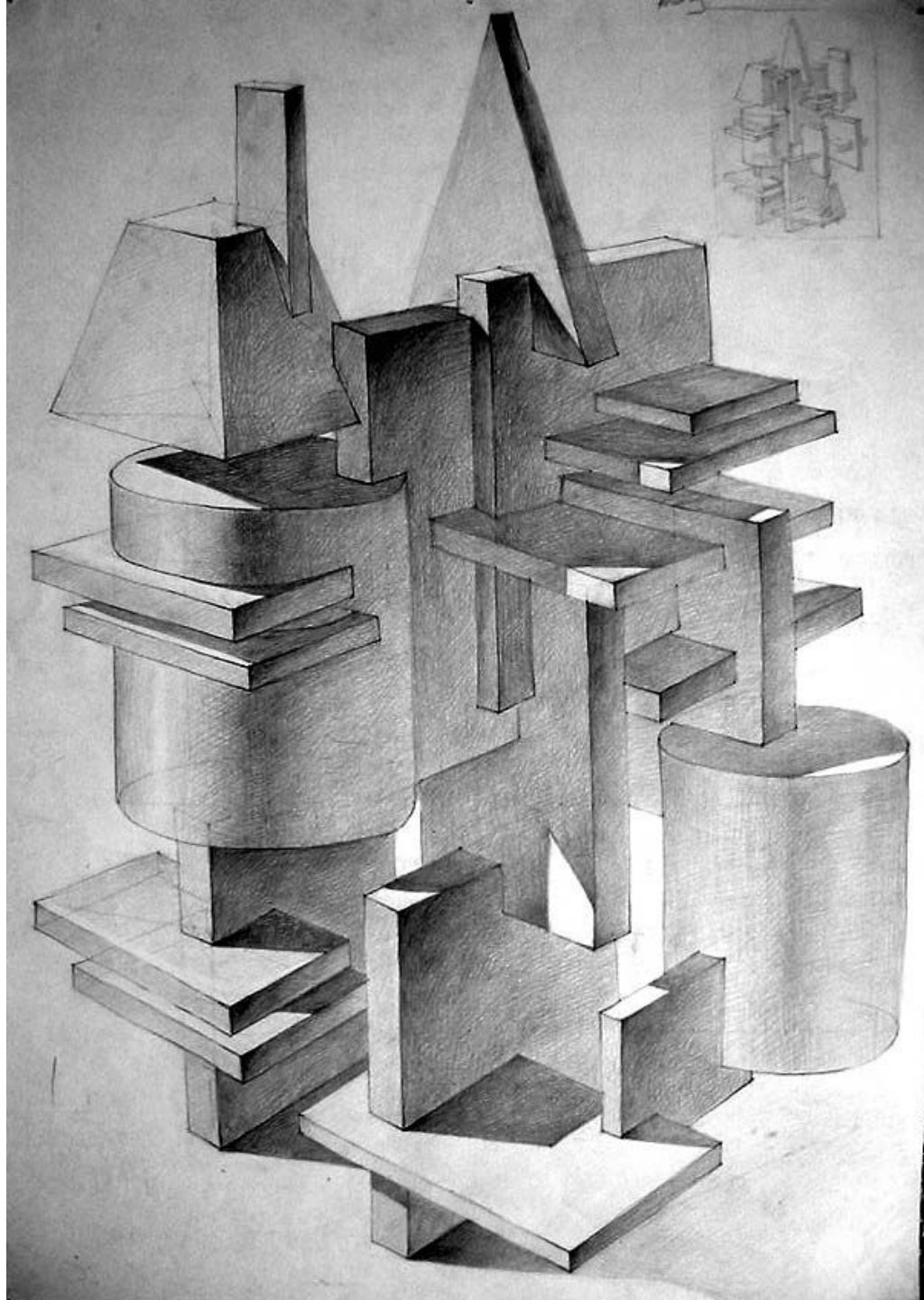

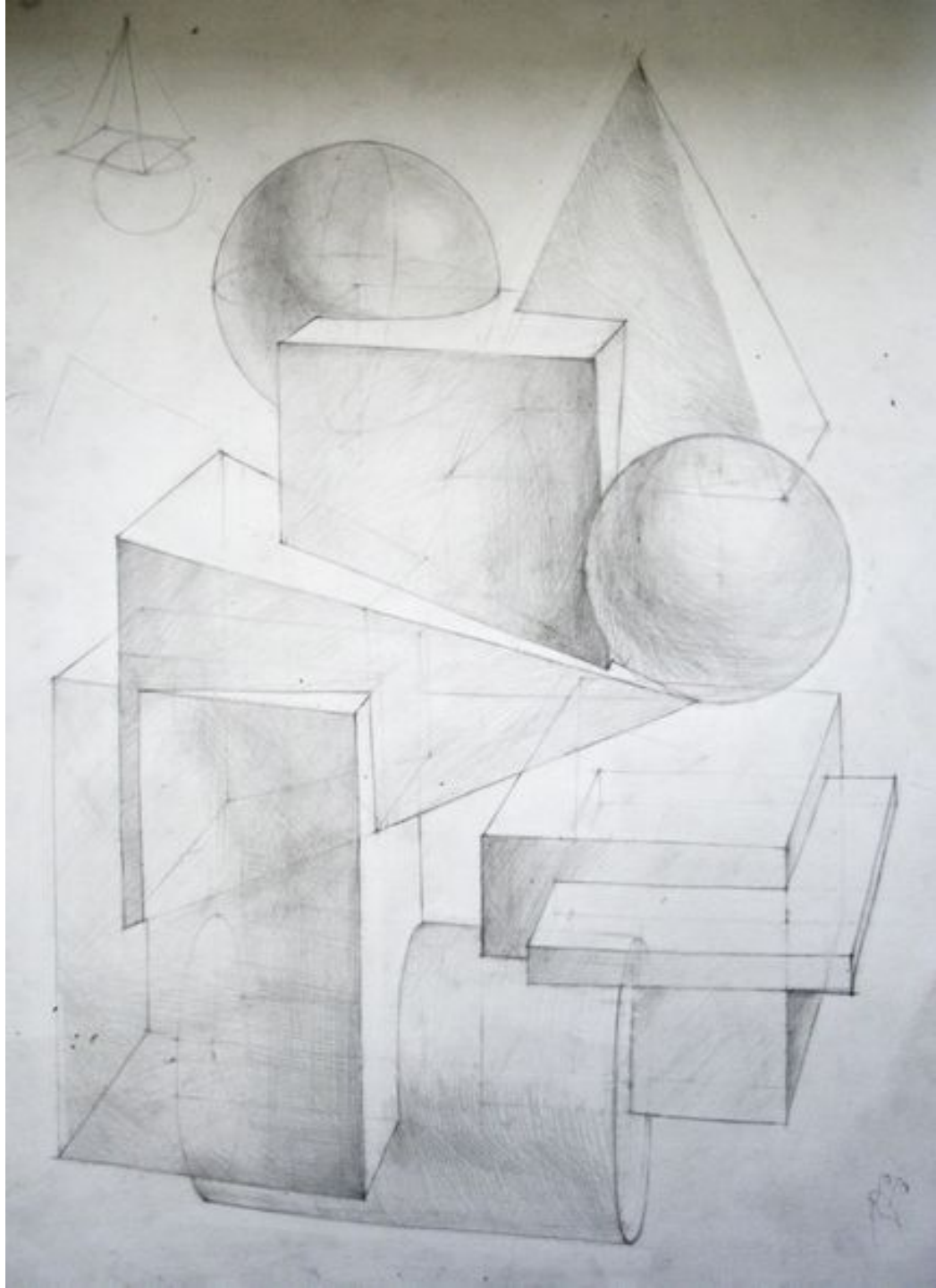

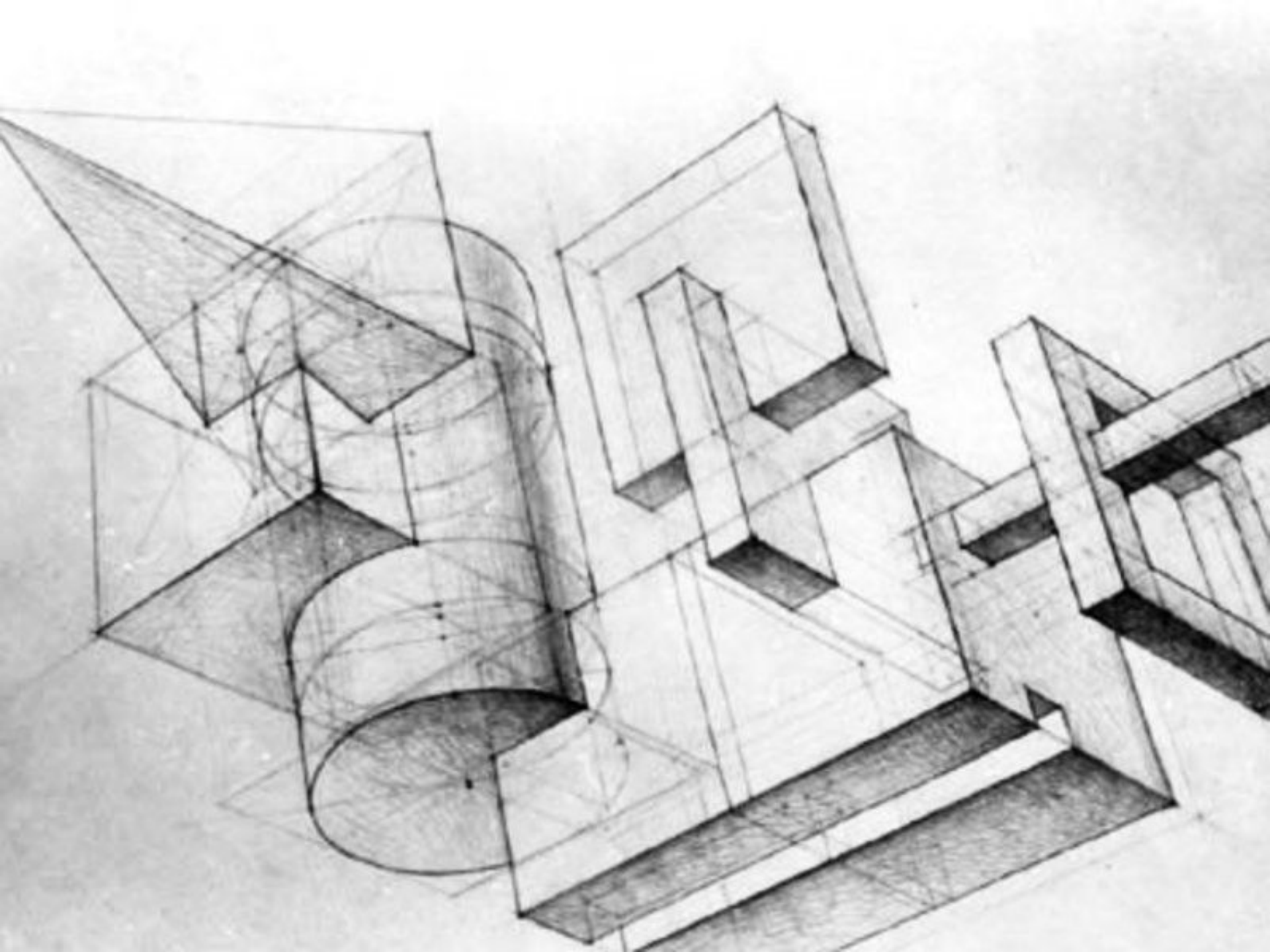

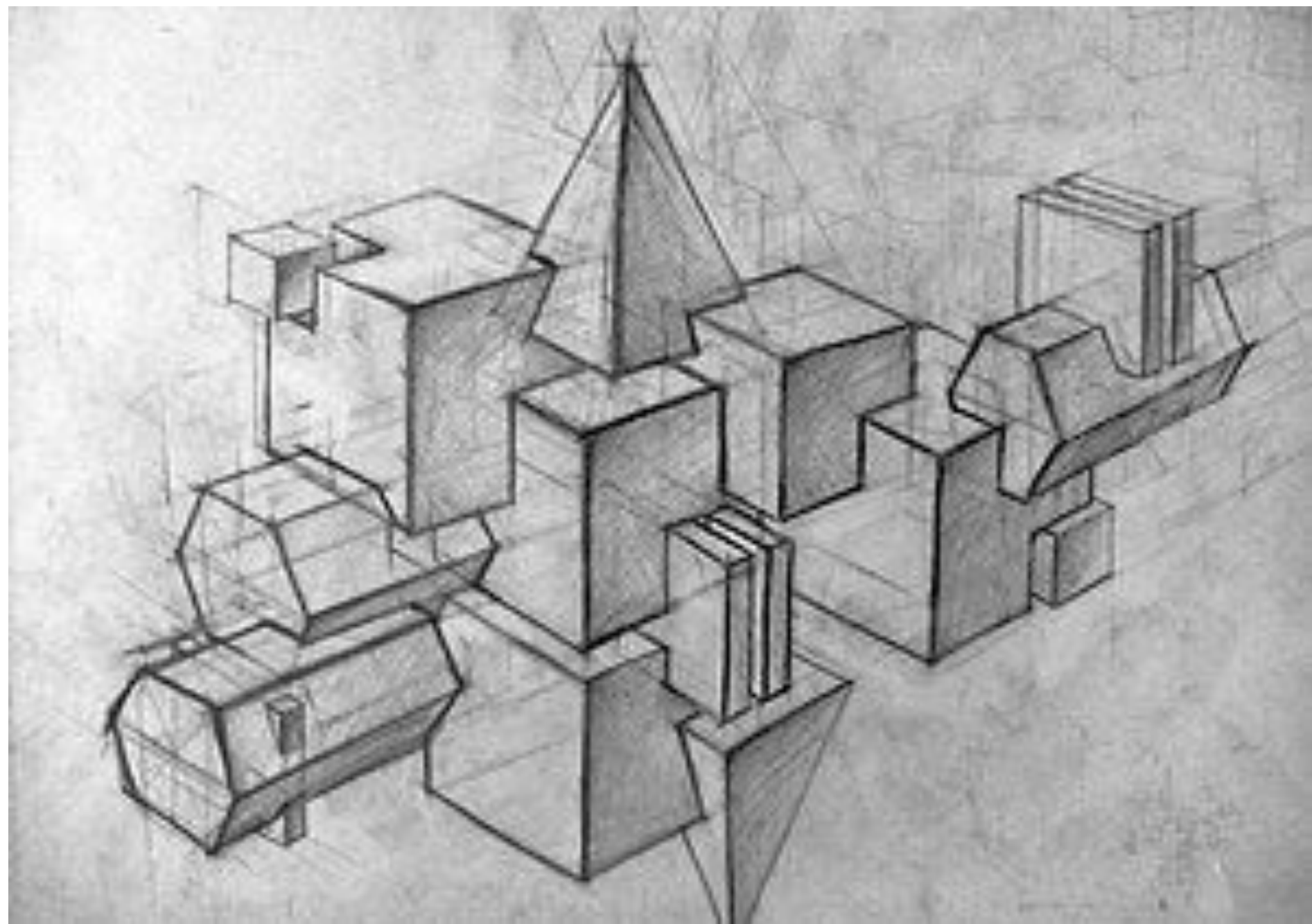

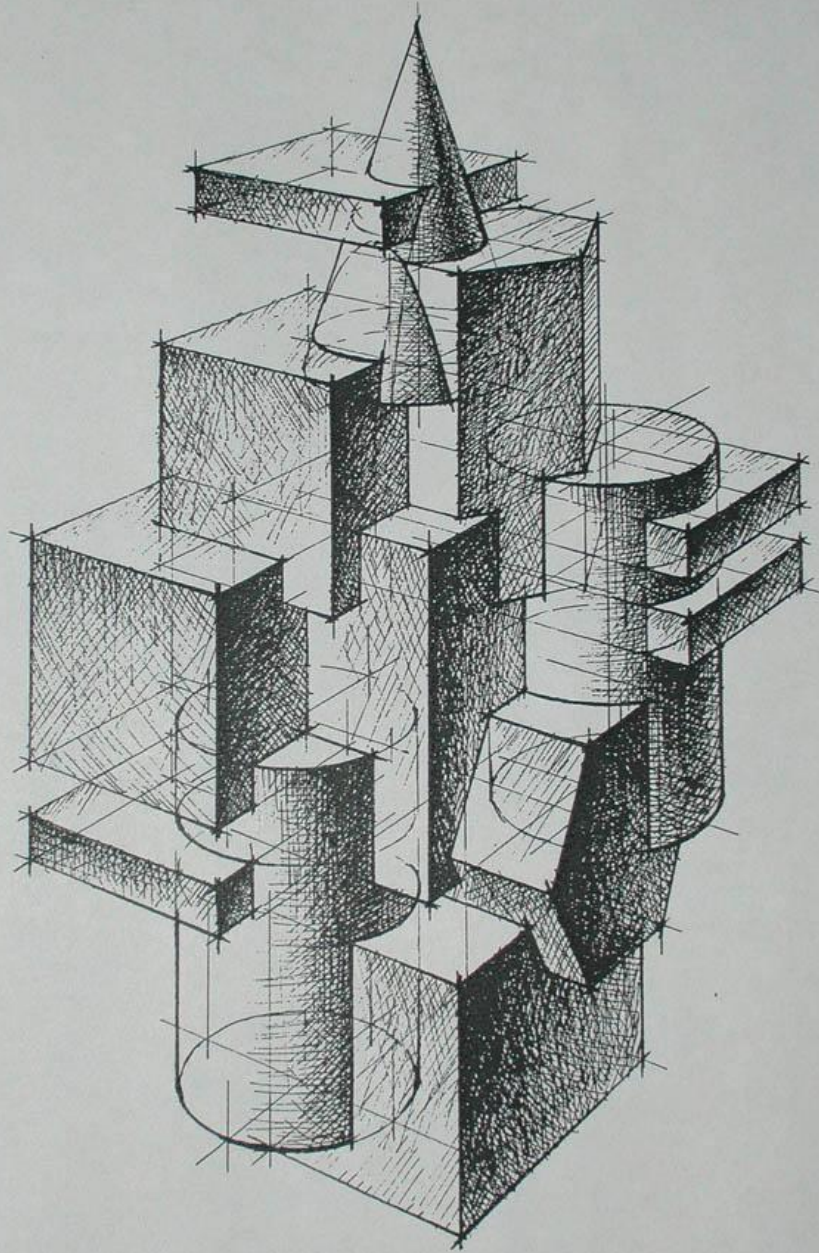

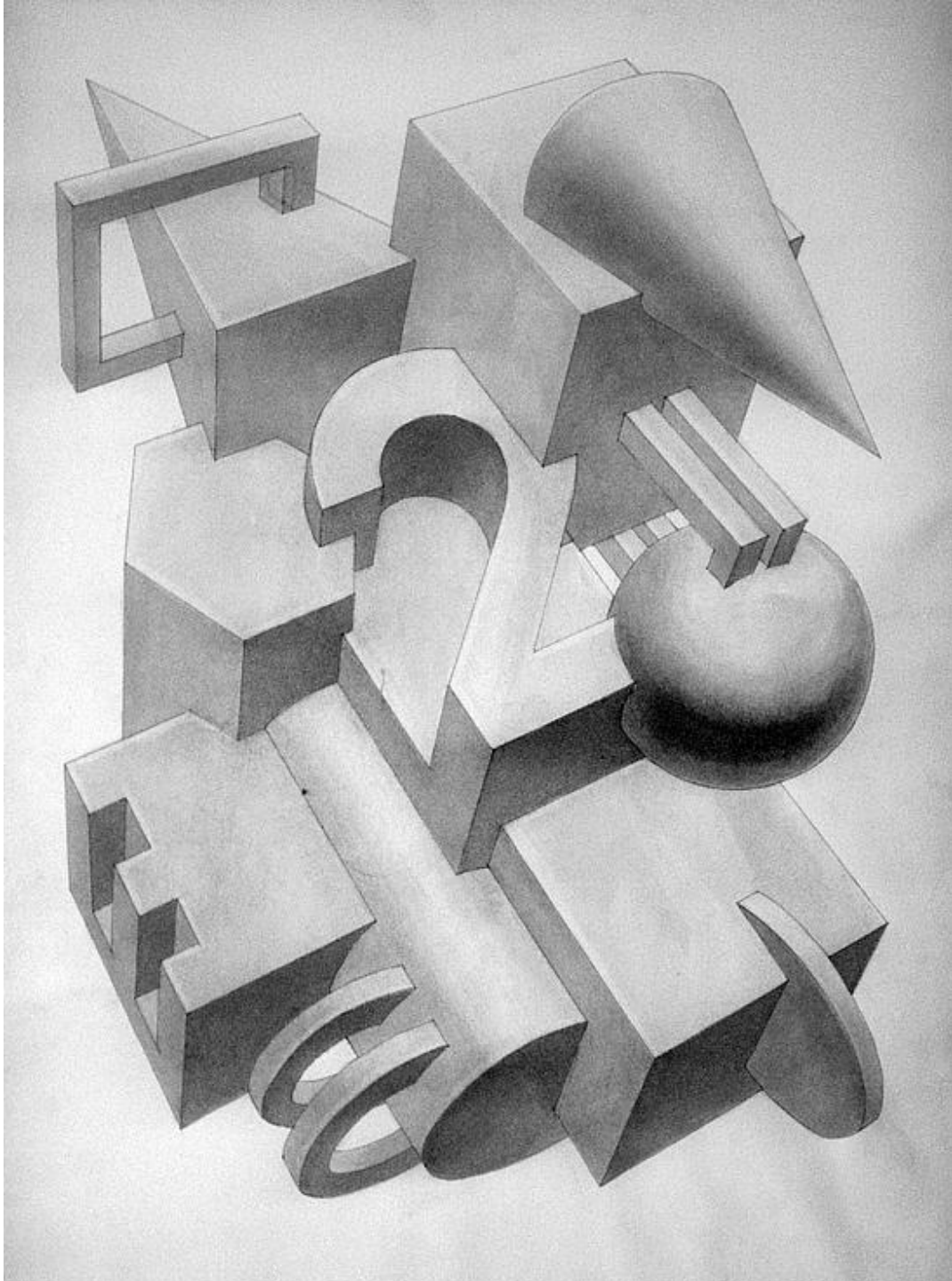

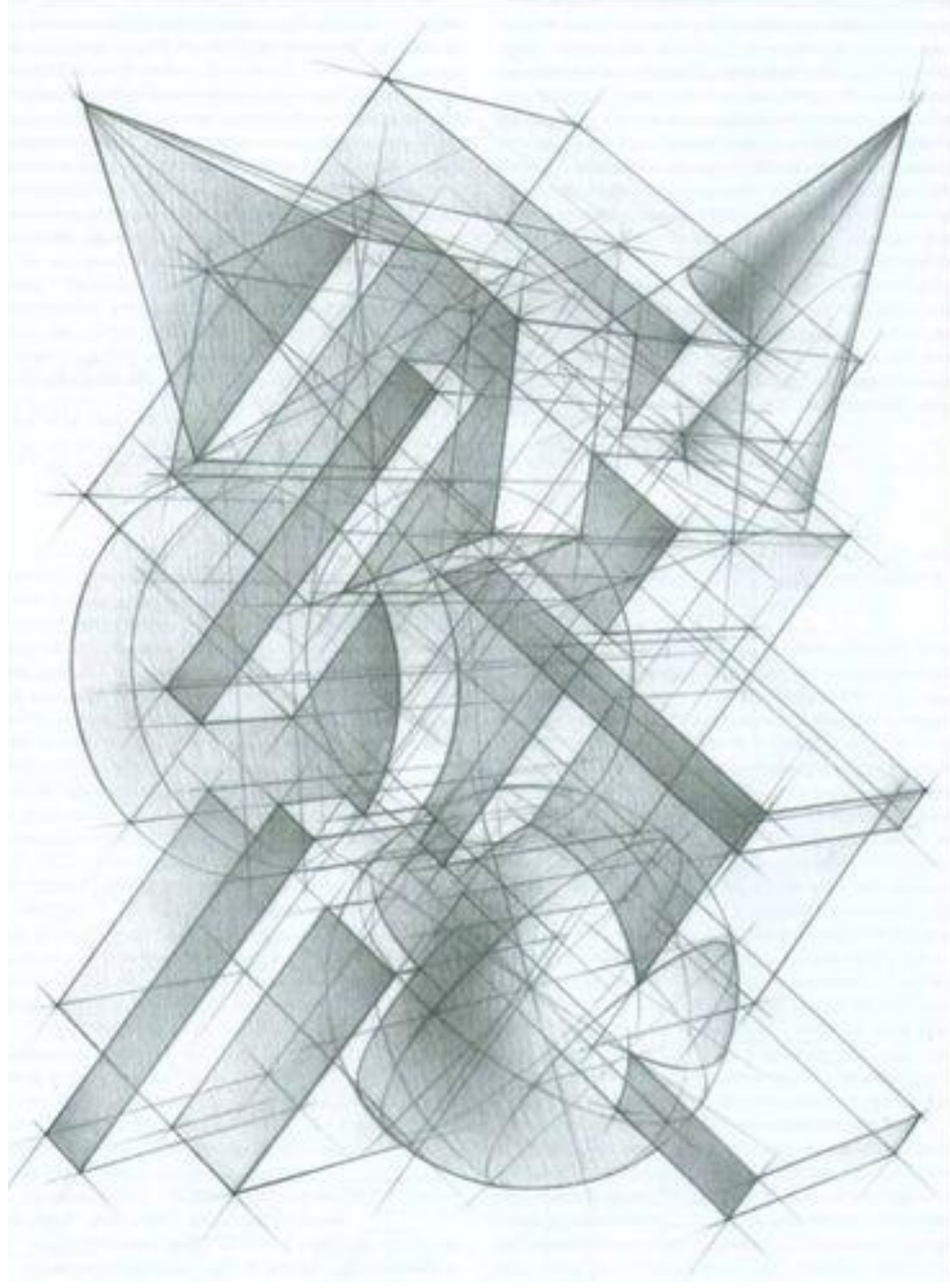

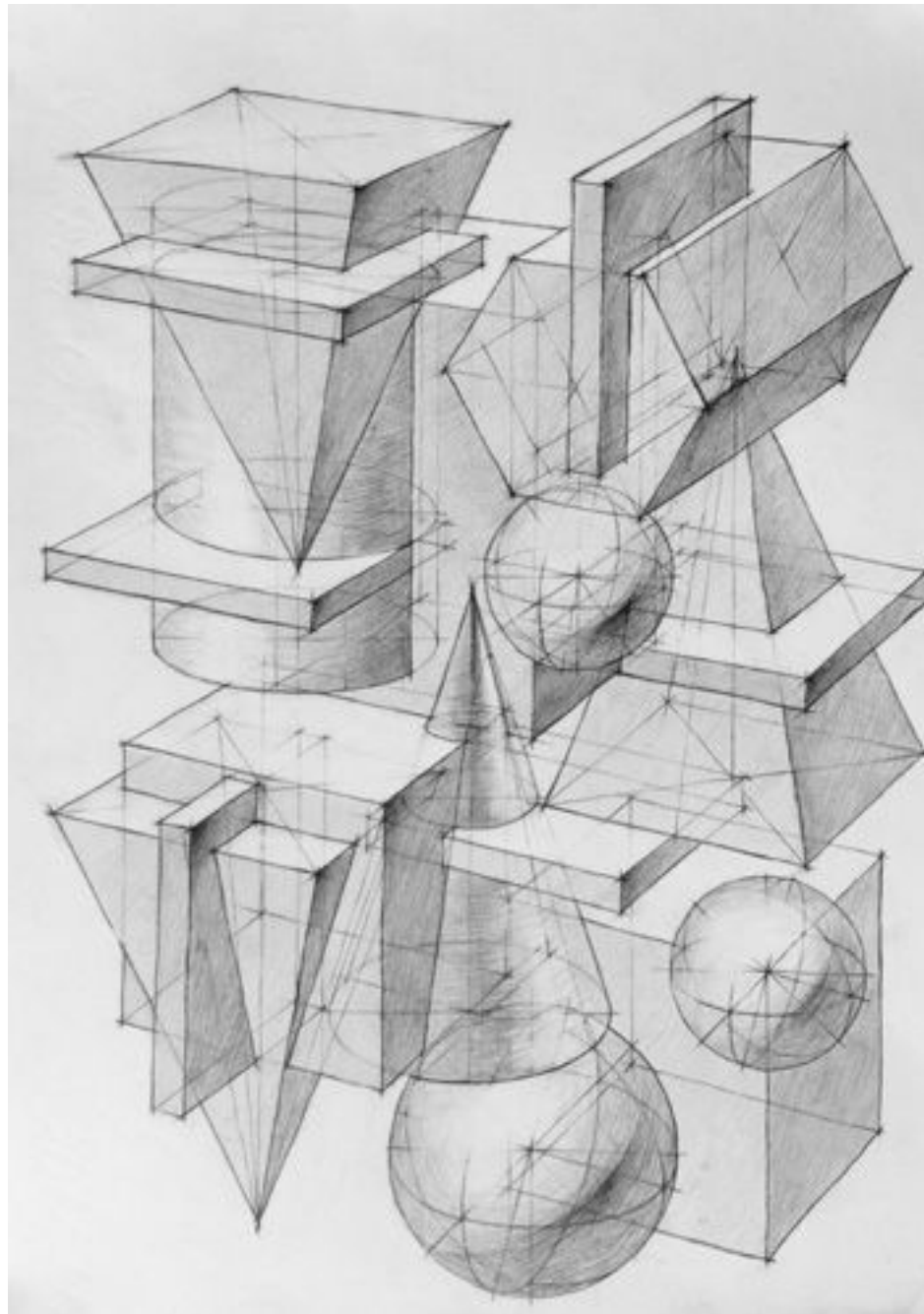

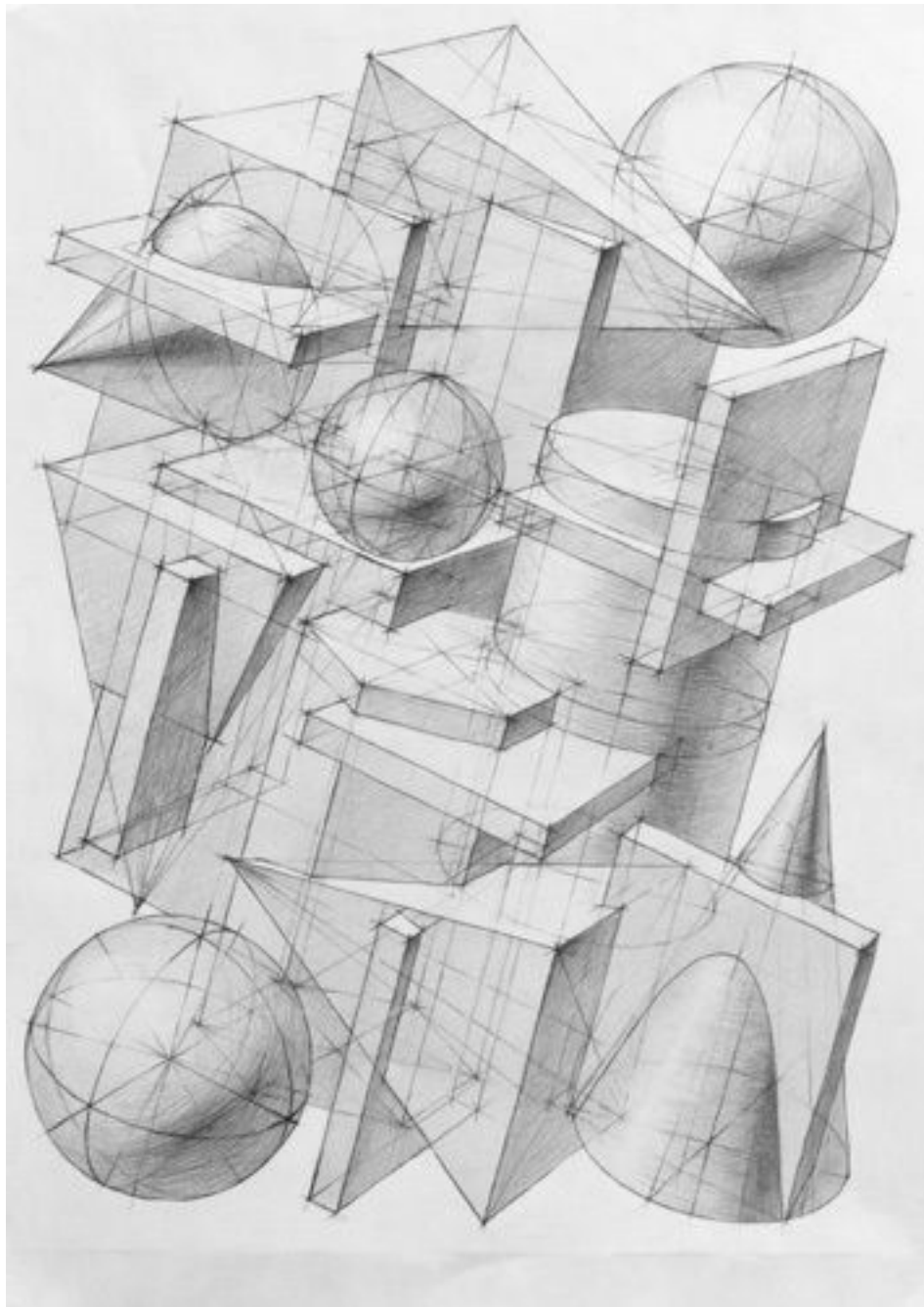

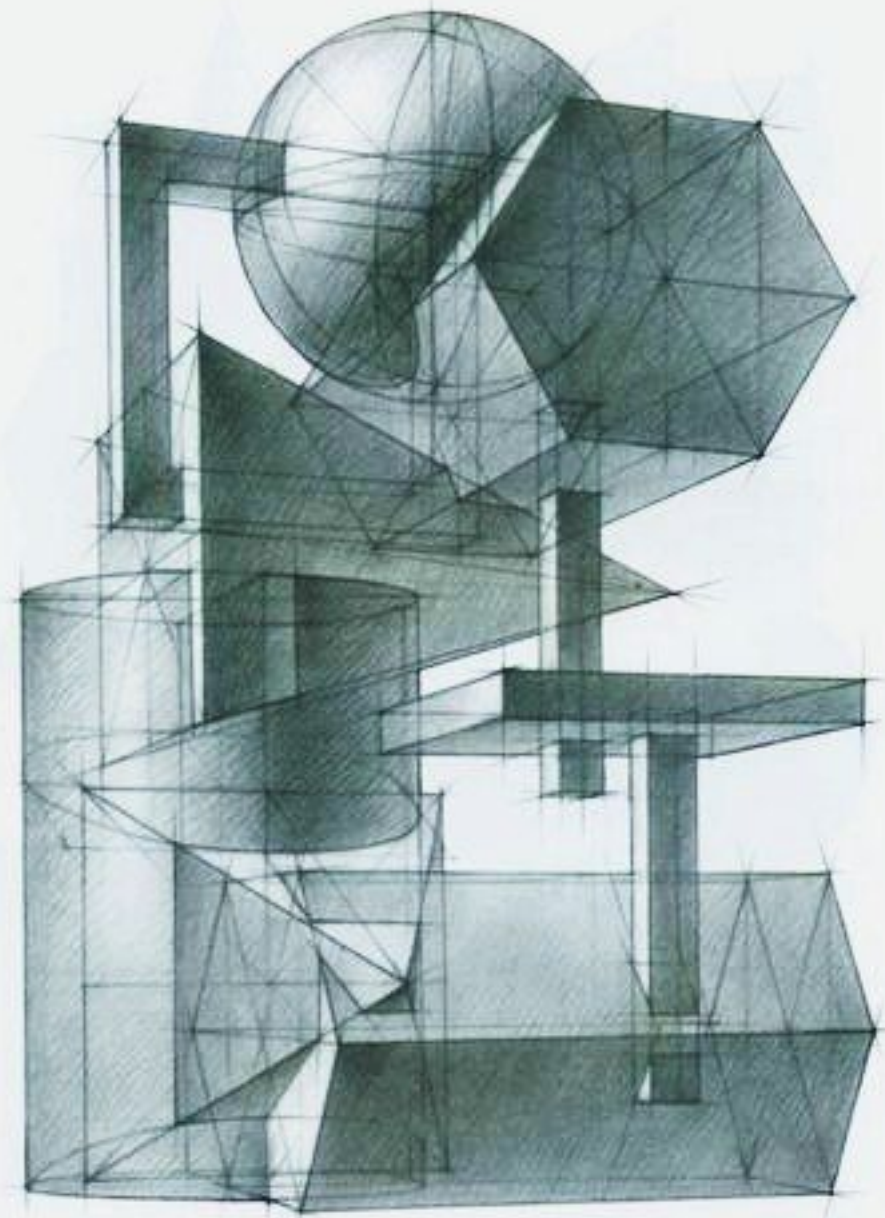

Pte. 6.7

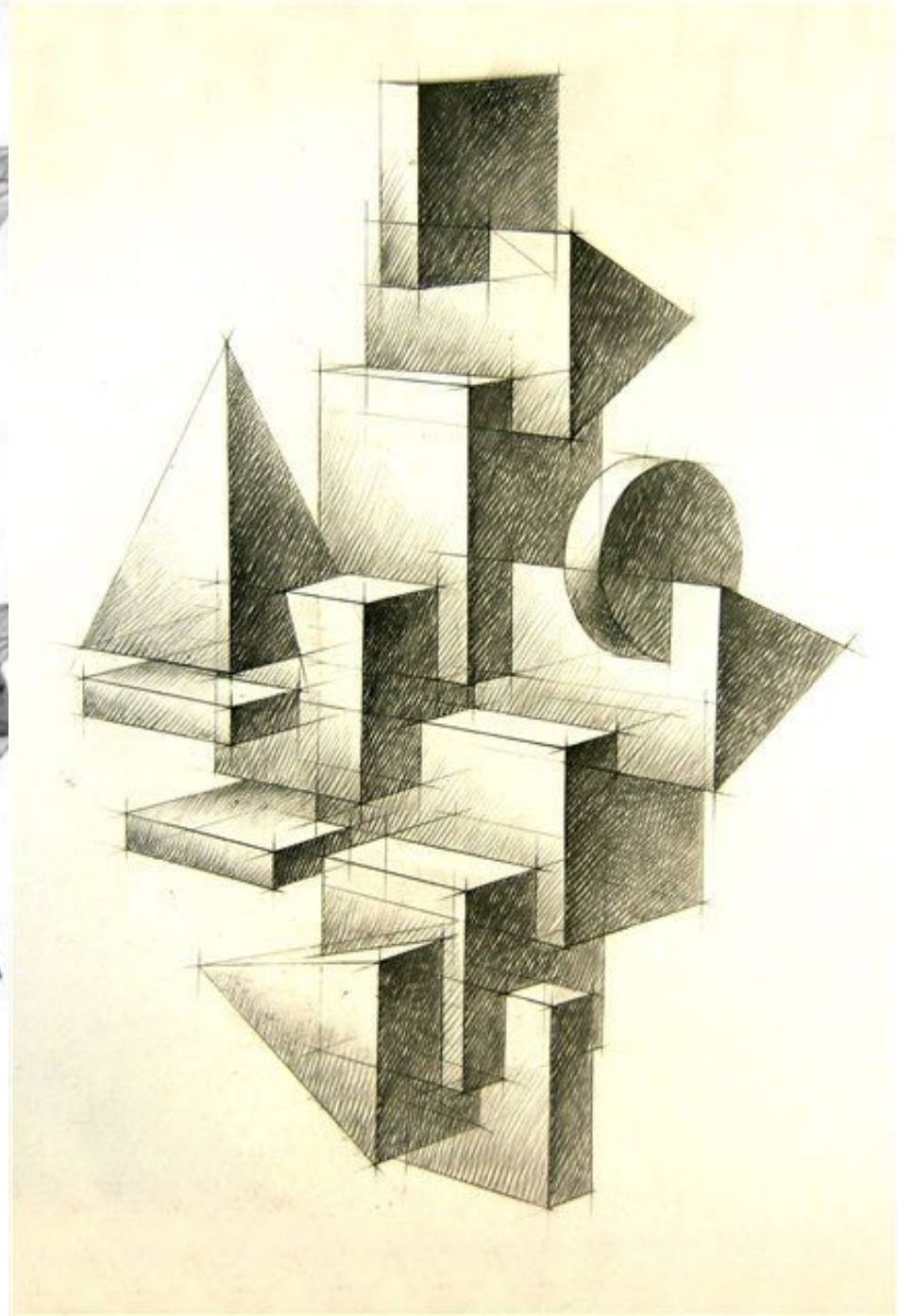
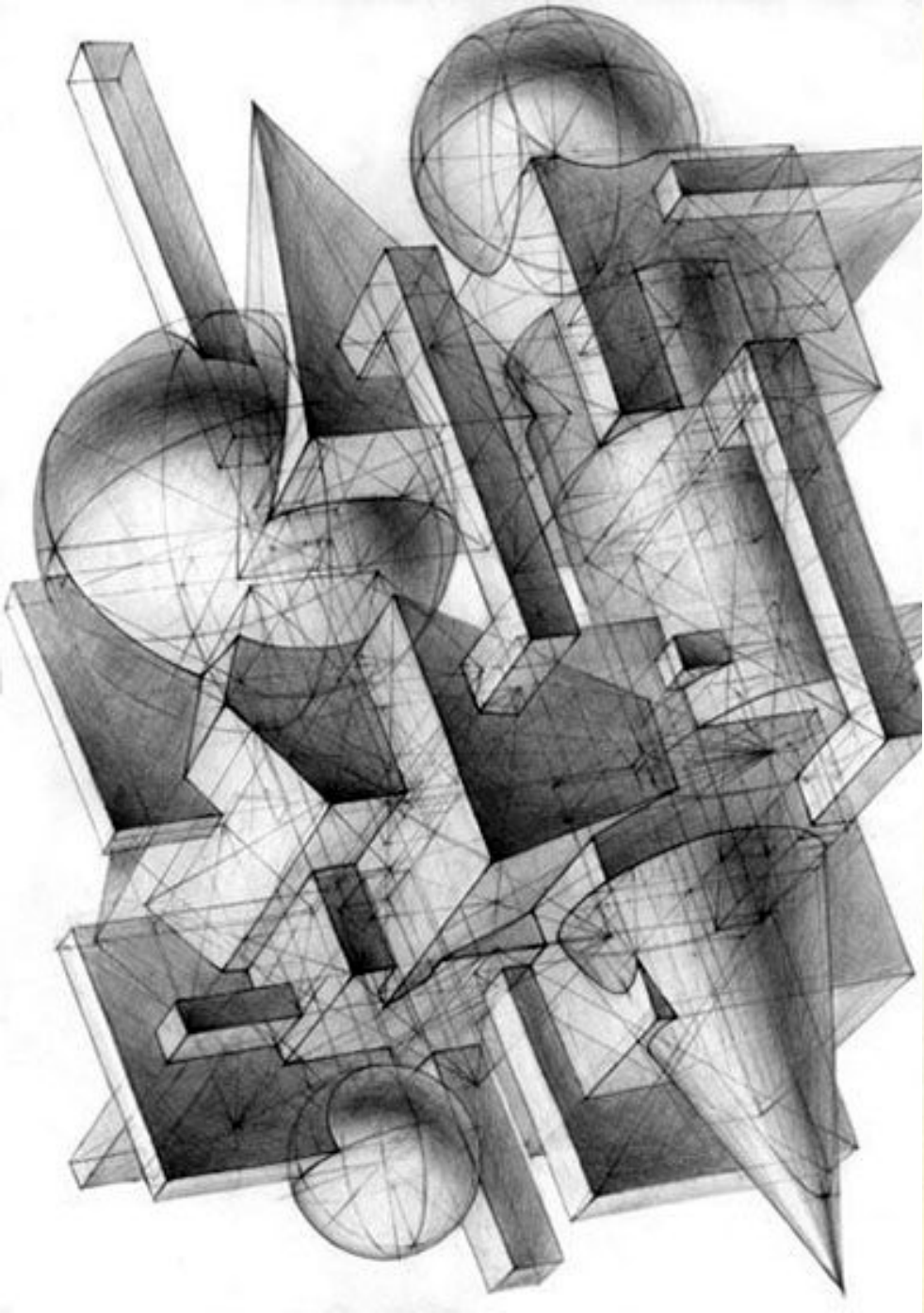

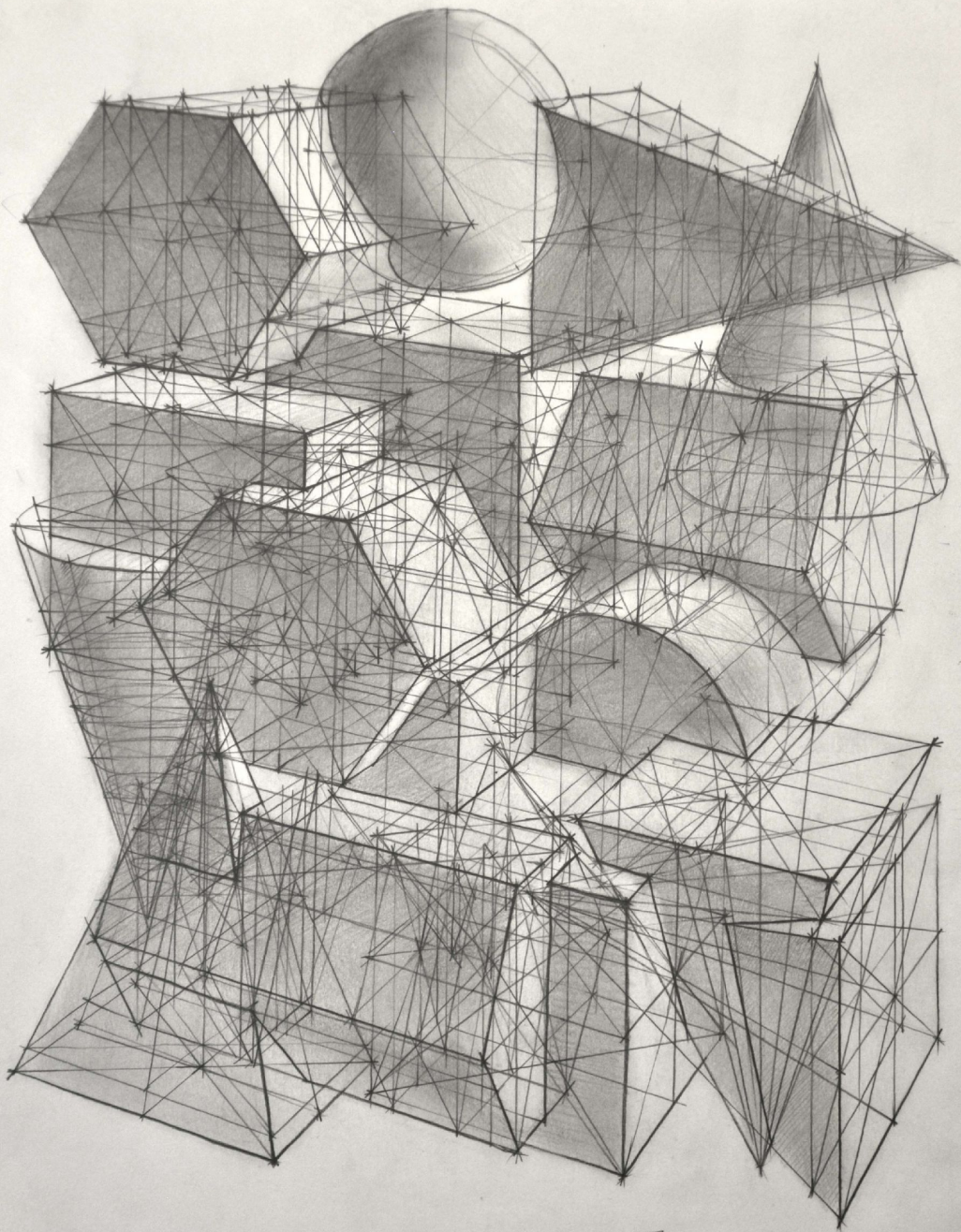

75-84

73

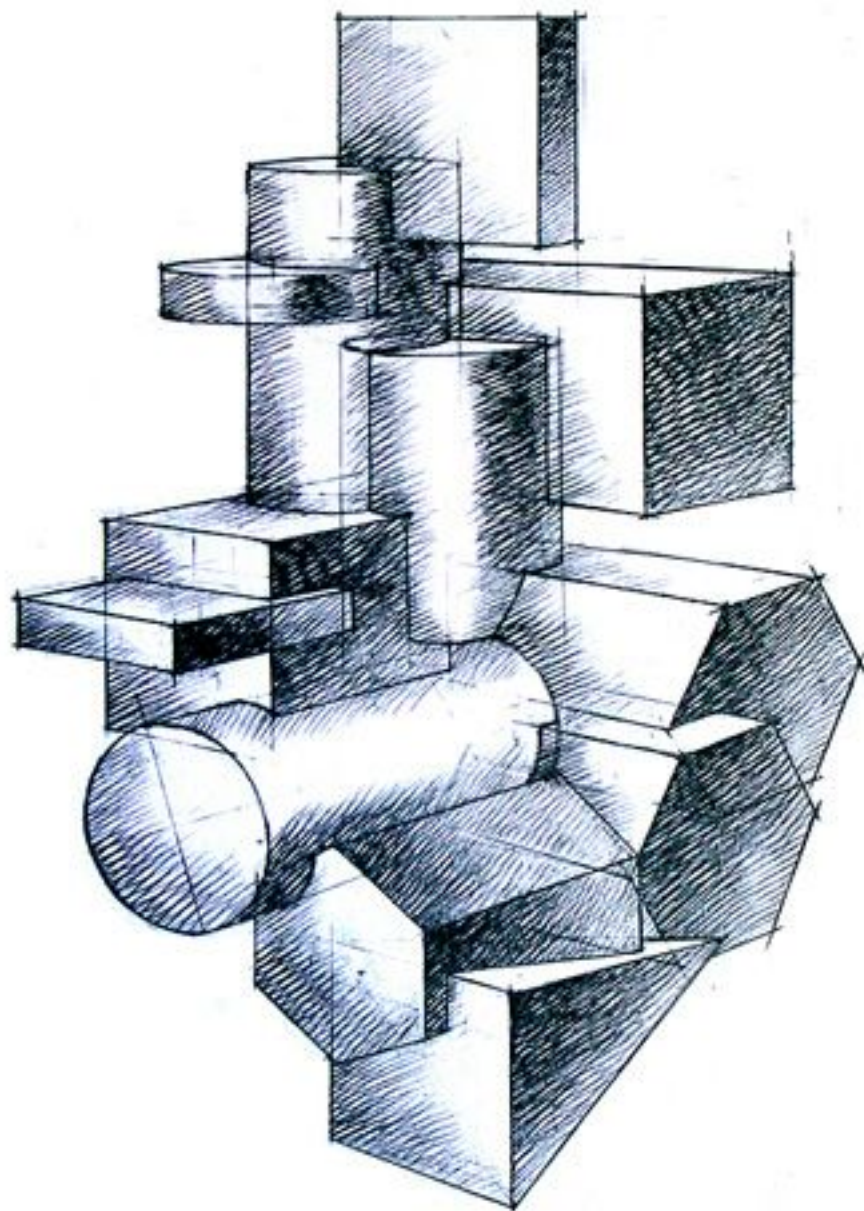

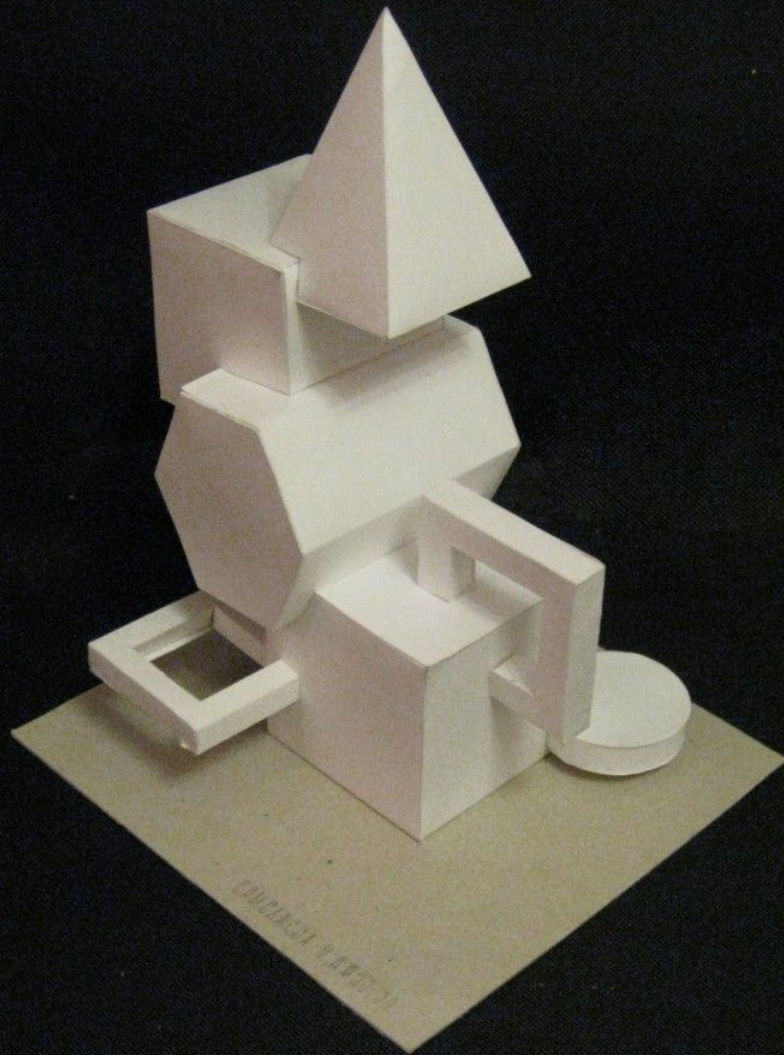

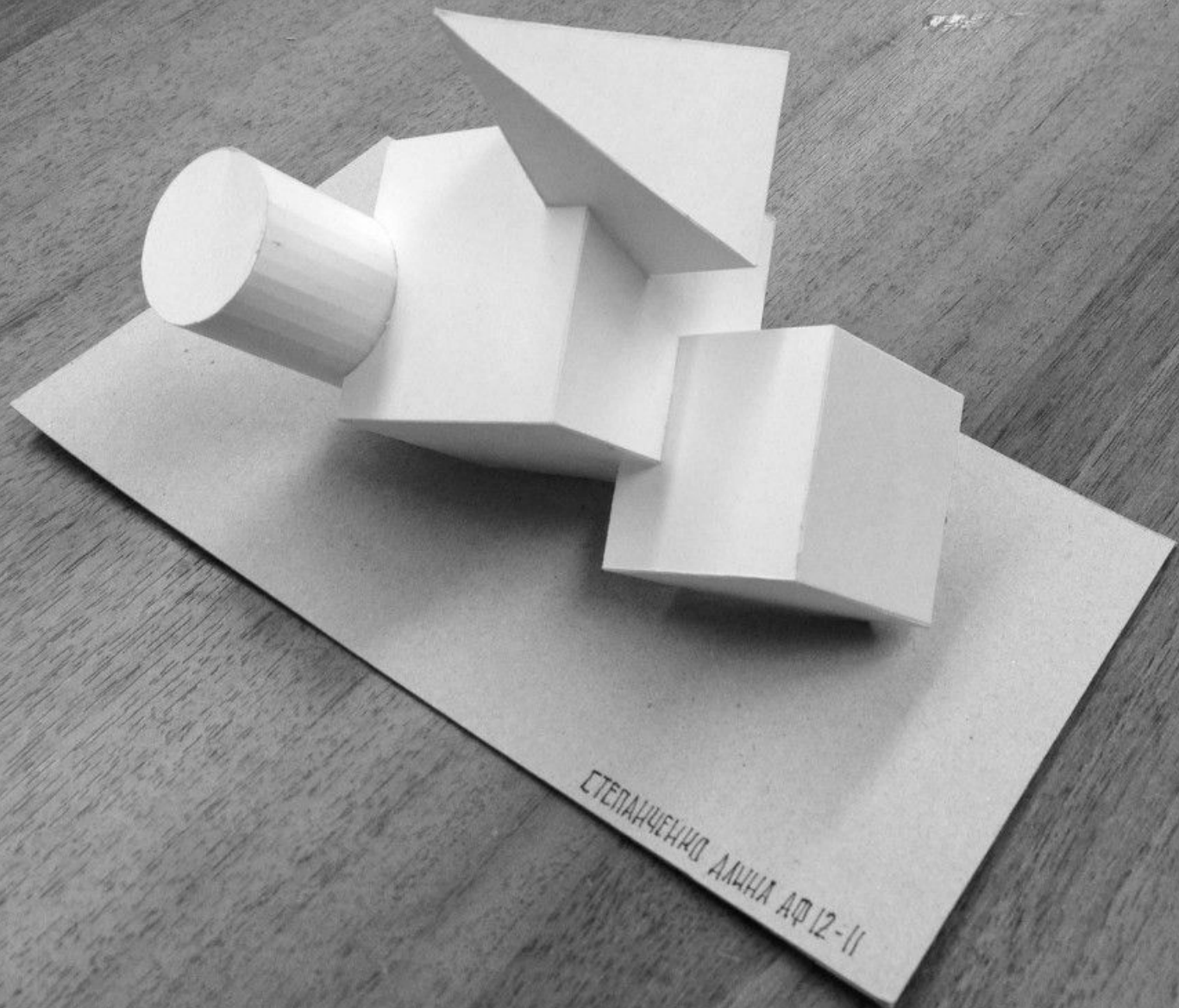

СТЕПАНЧЕНКО АЛНА АФ 12-11

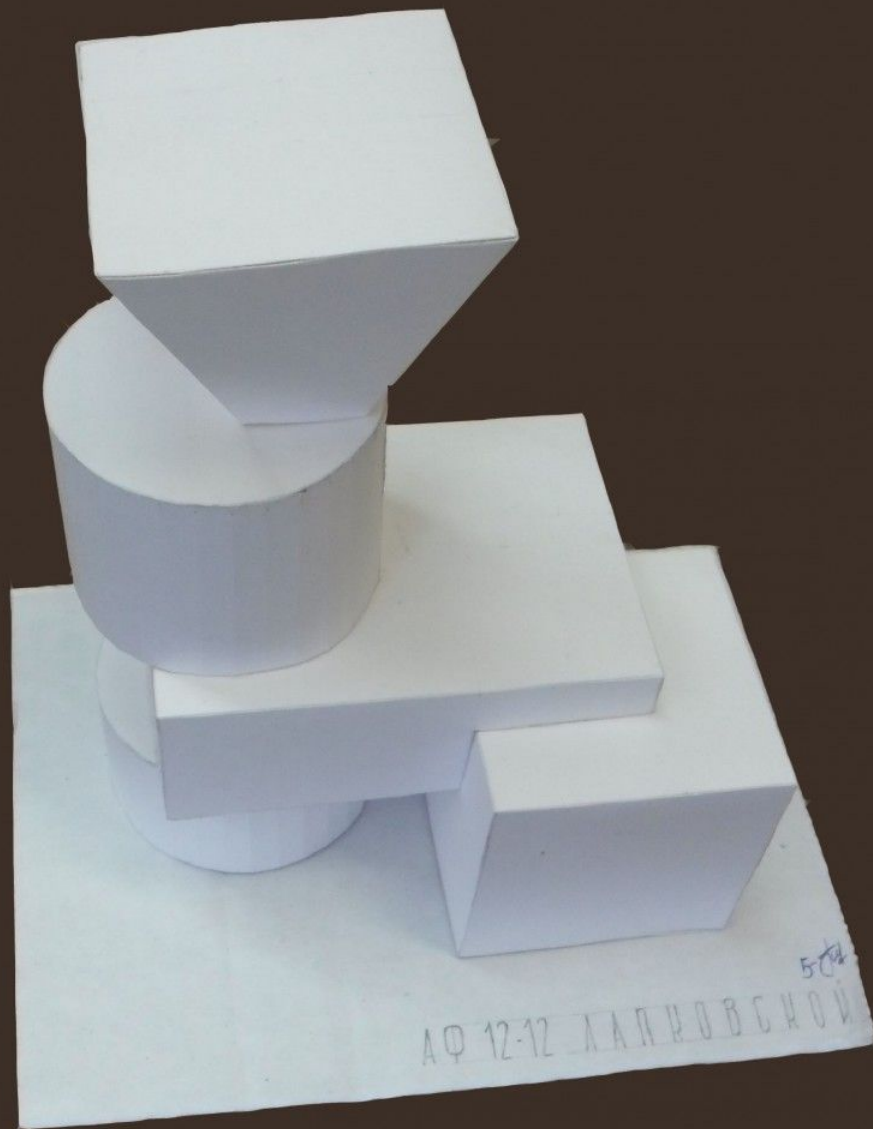

АФ 12-12 ЛАПРОВСКОЙ
502

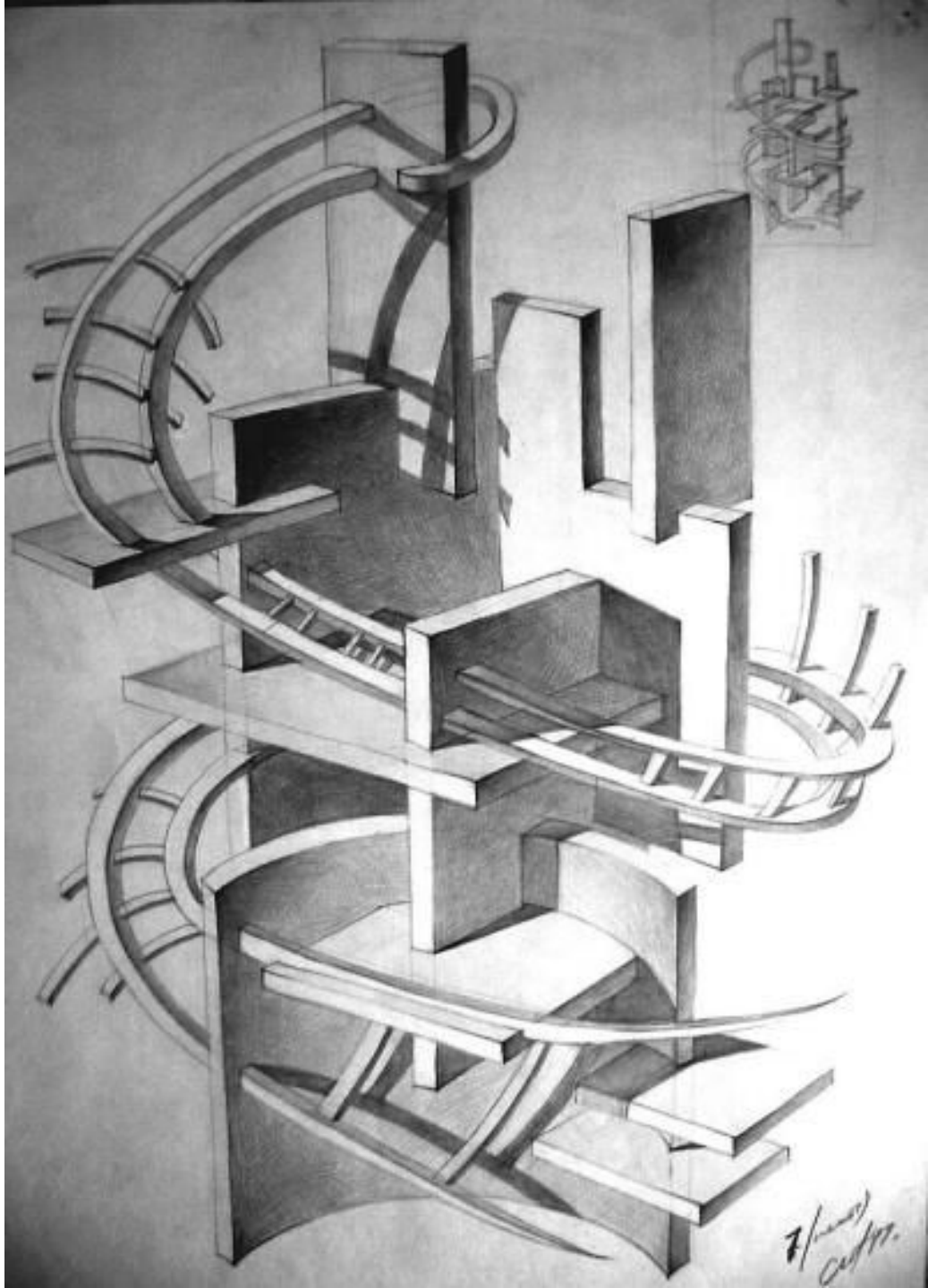

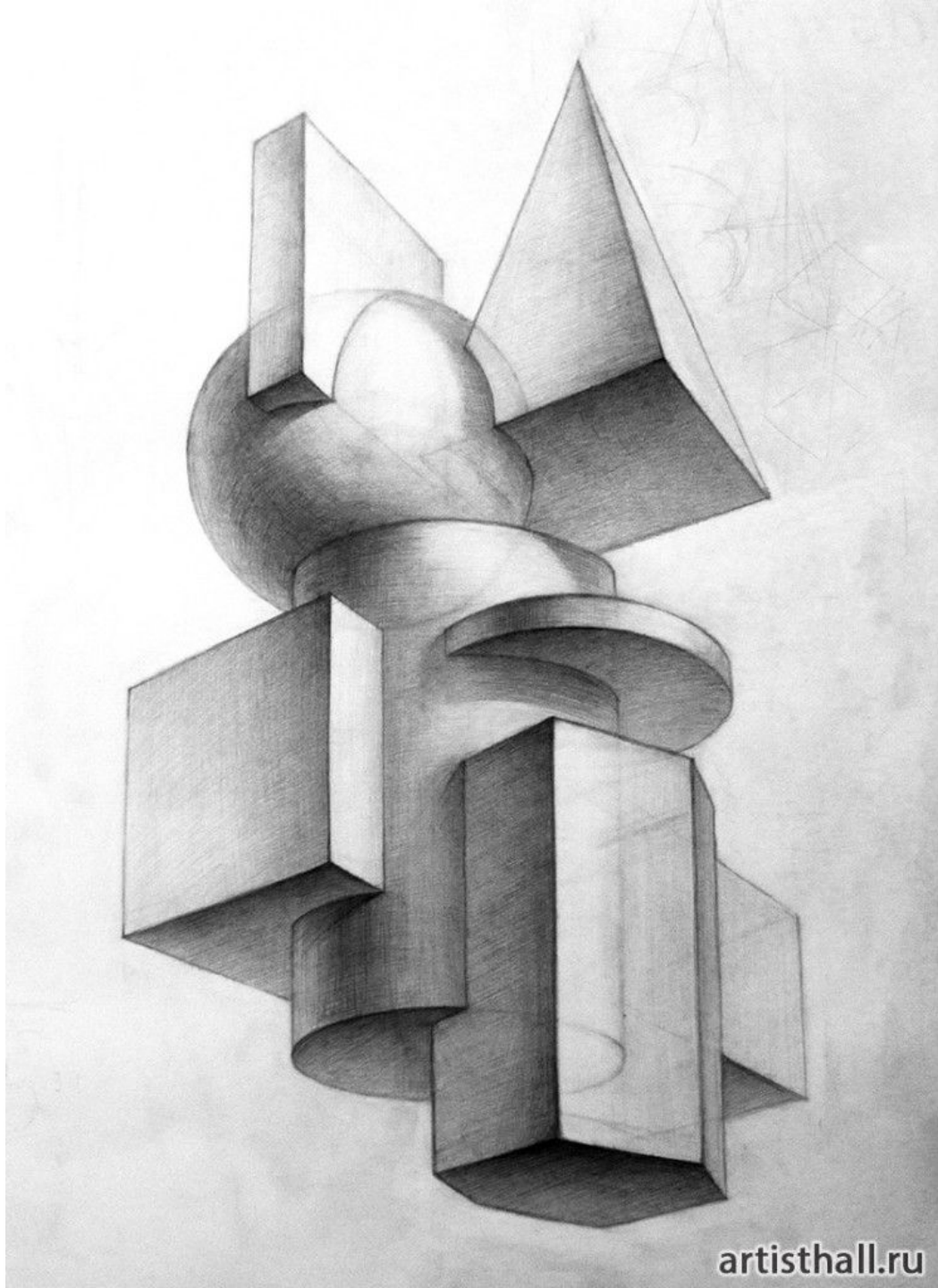

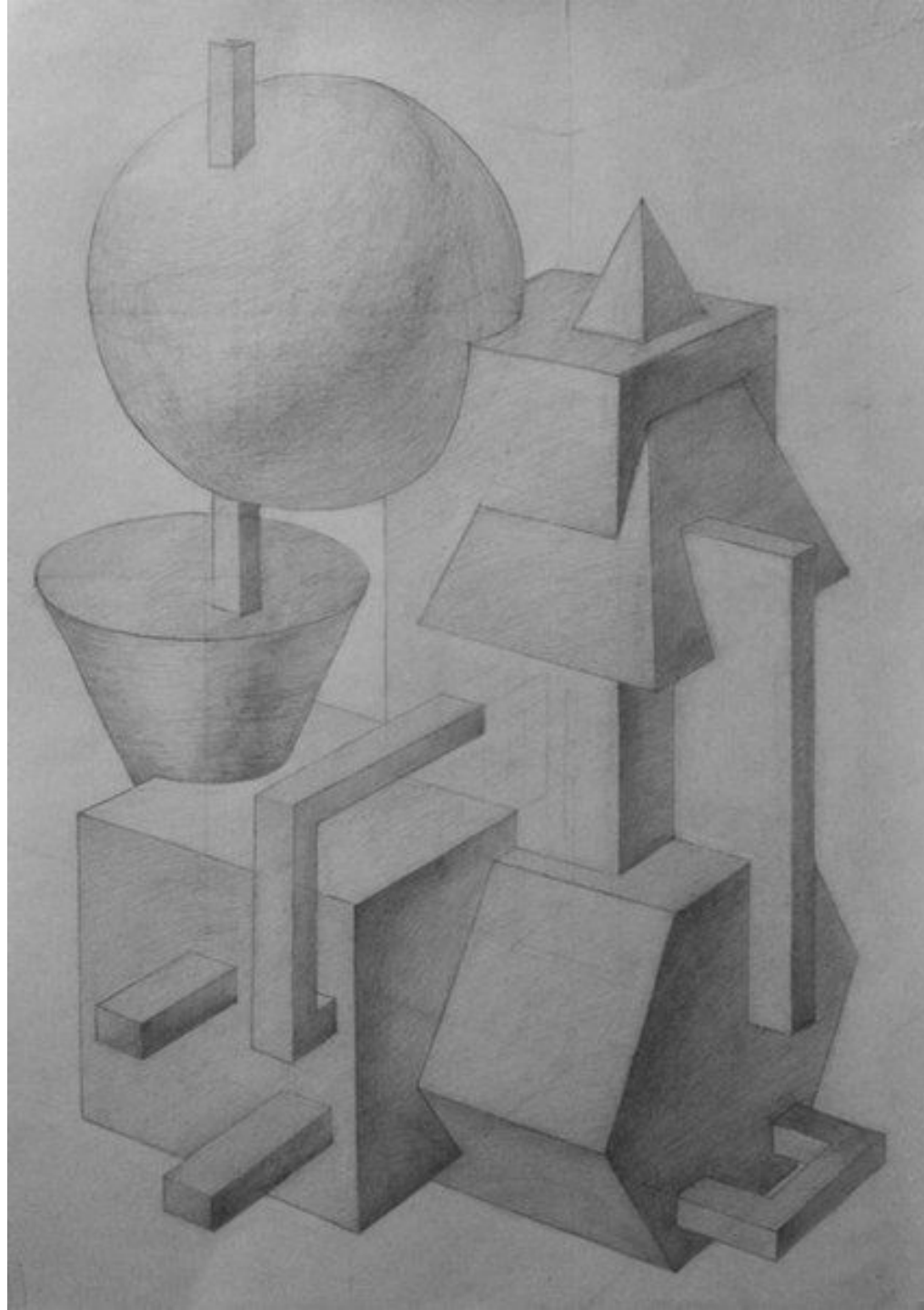

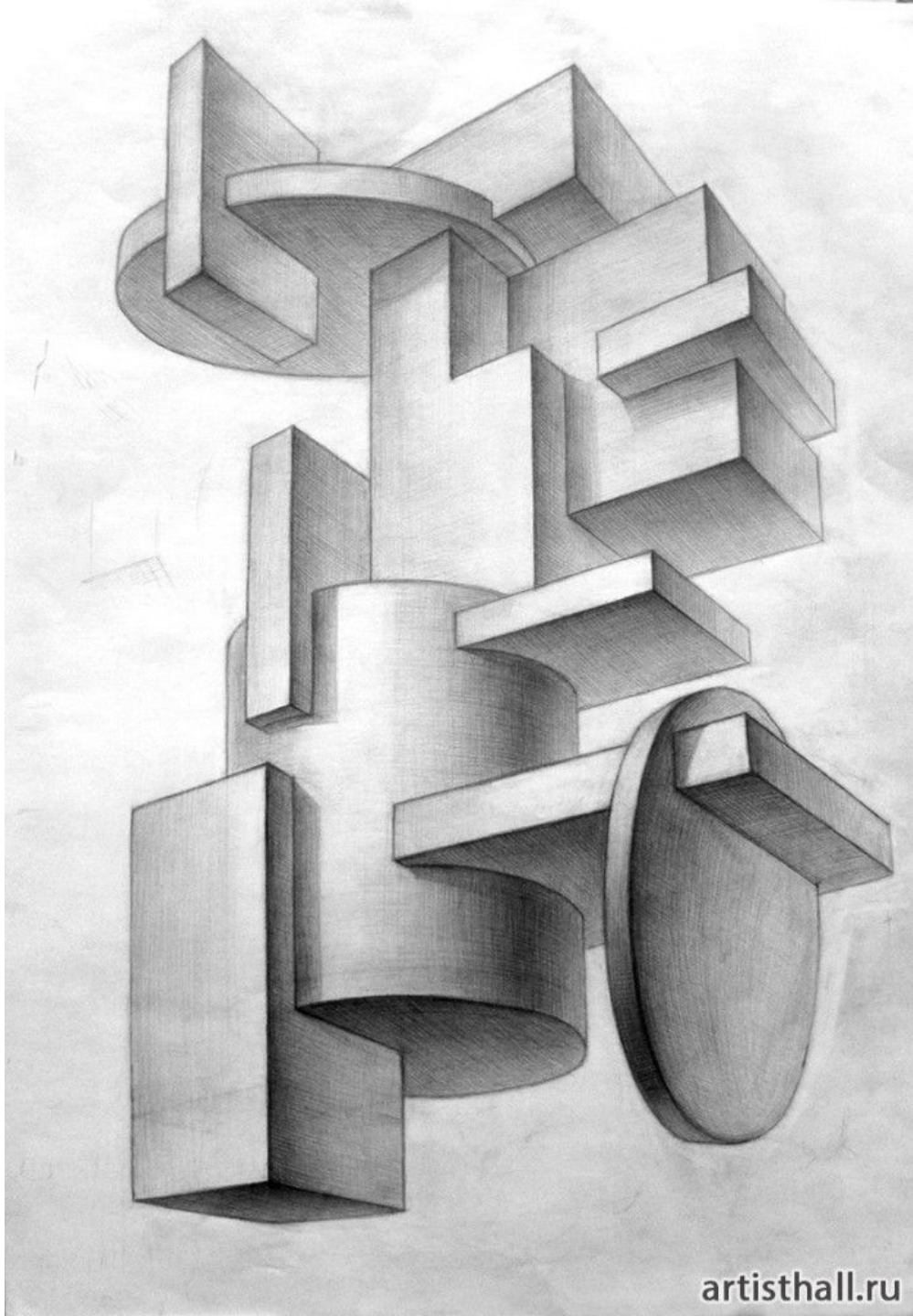

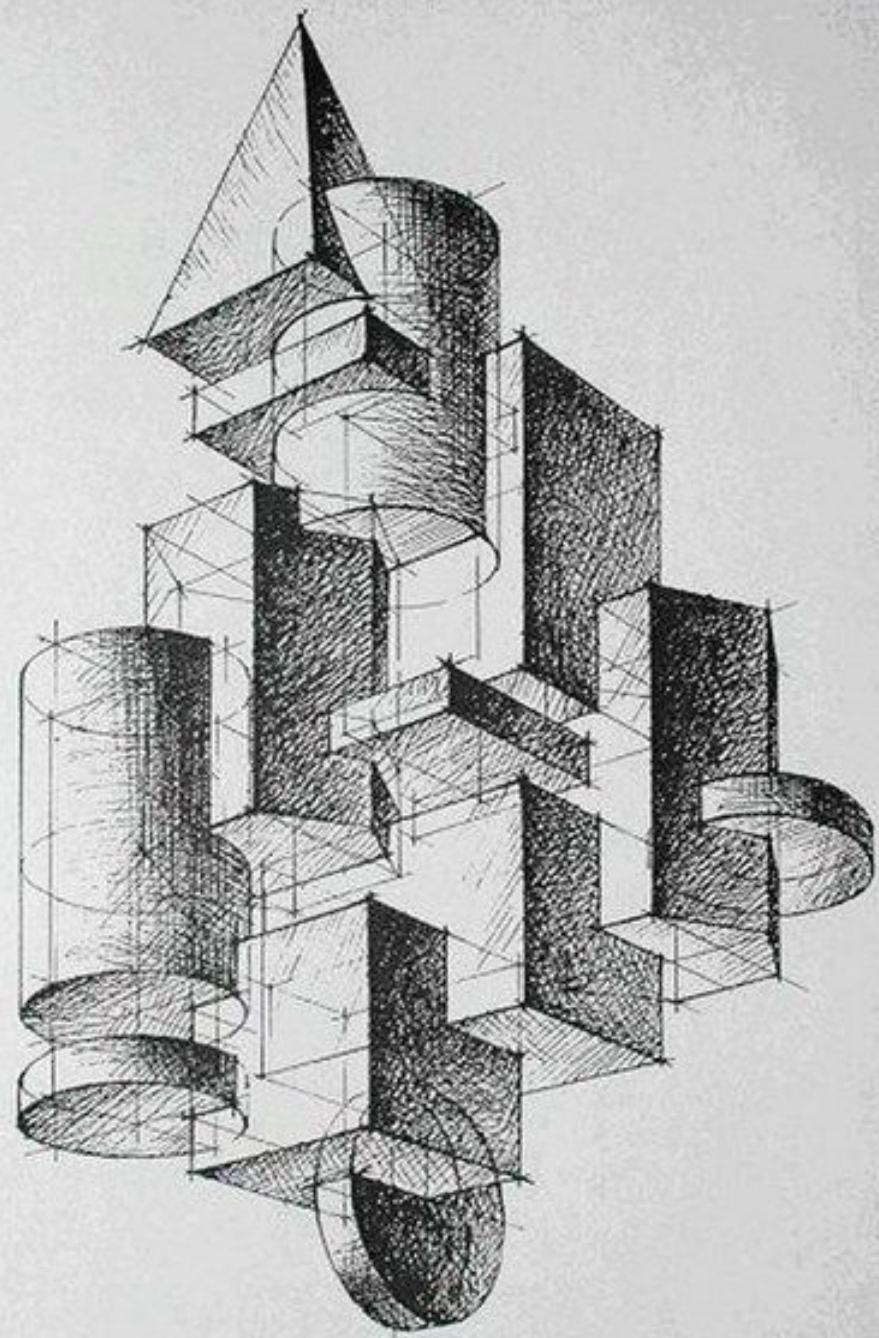
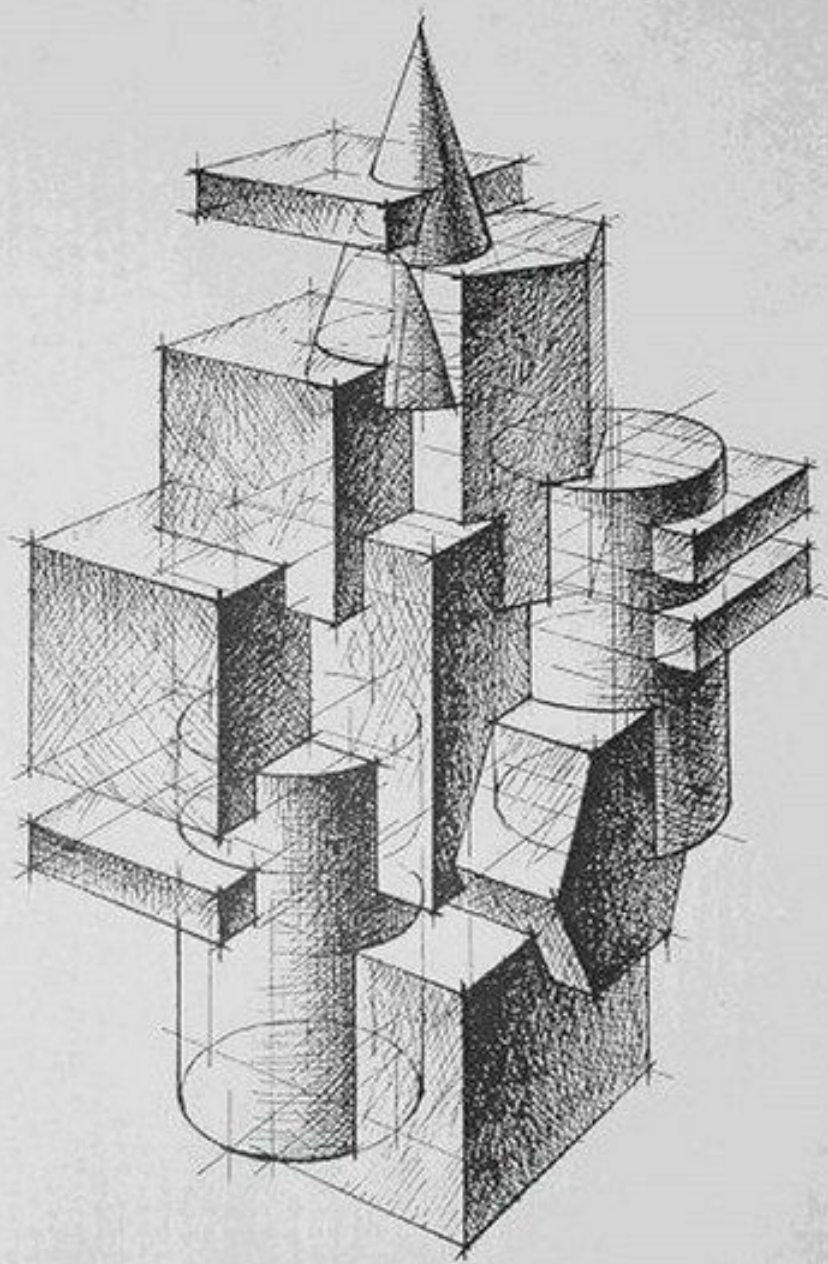



Рис. 6.15



Рис. 6.10

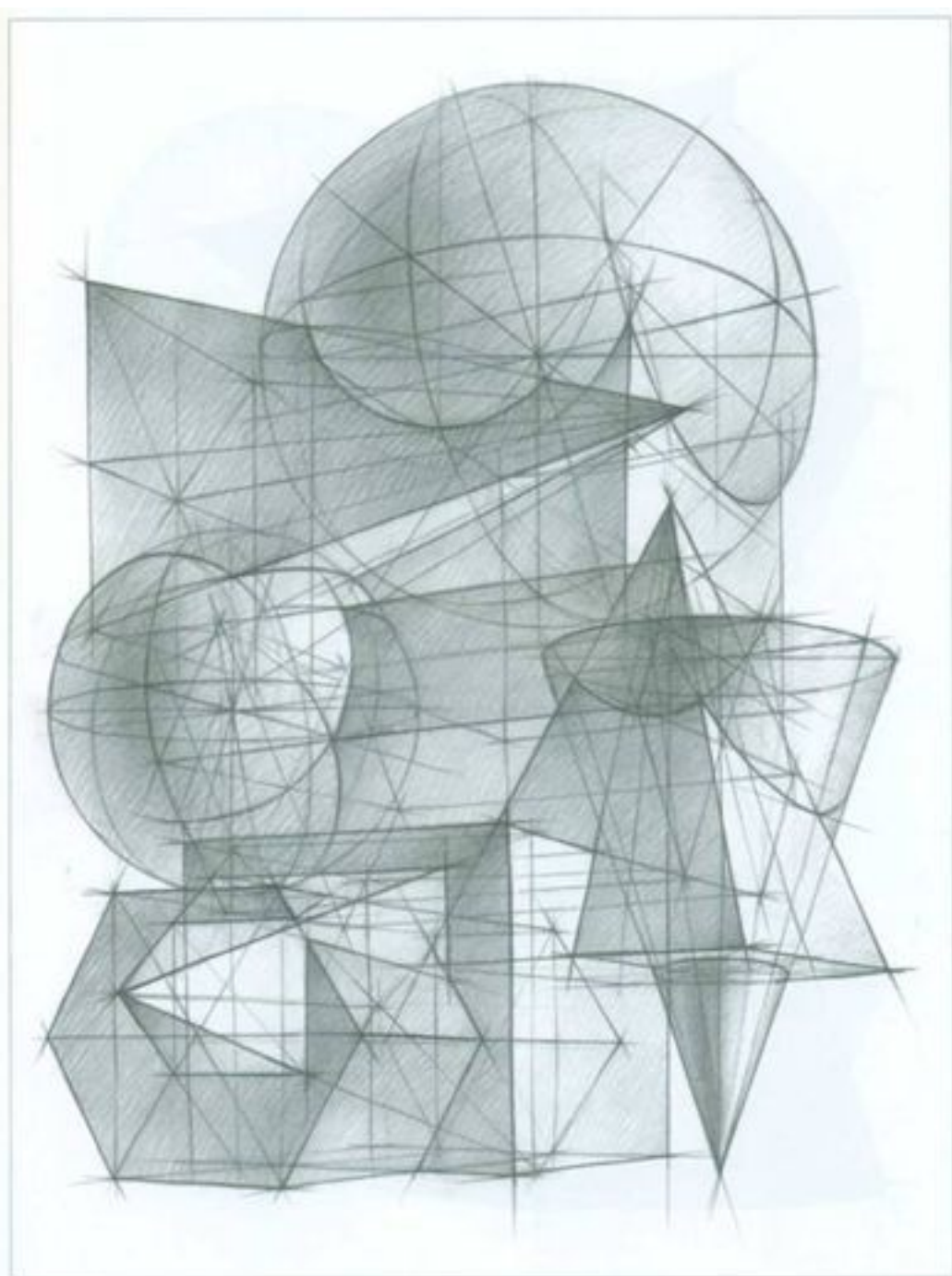

Рис. 6.5

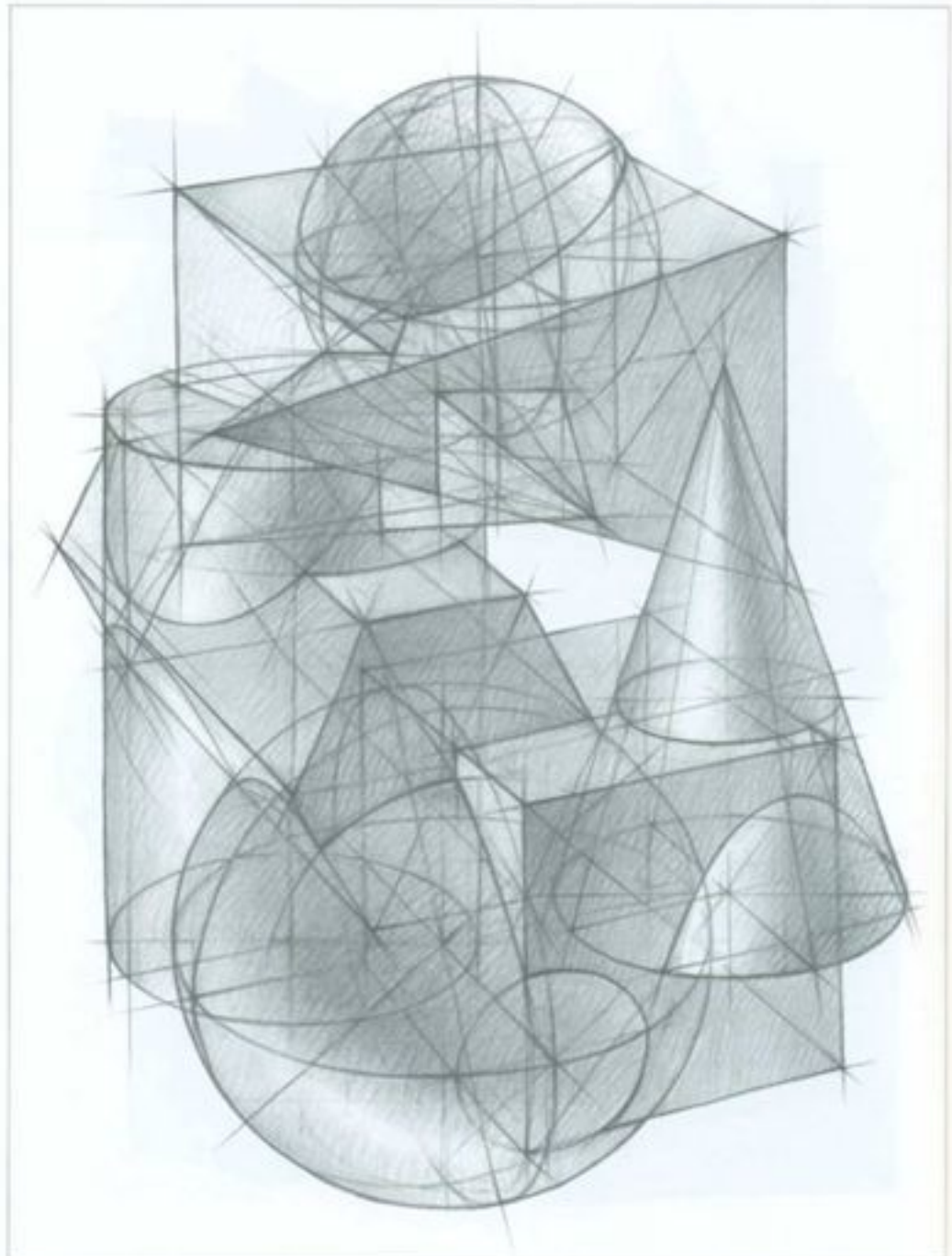

Рис. 6.4

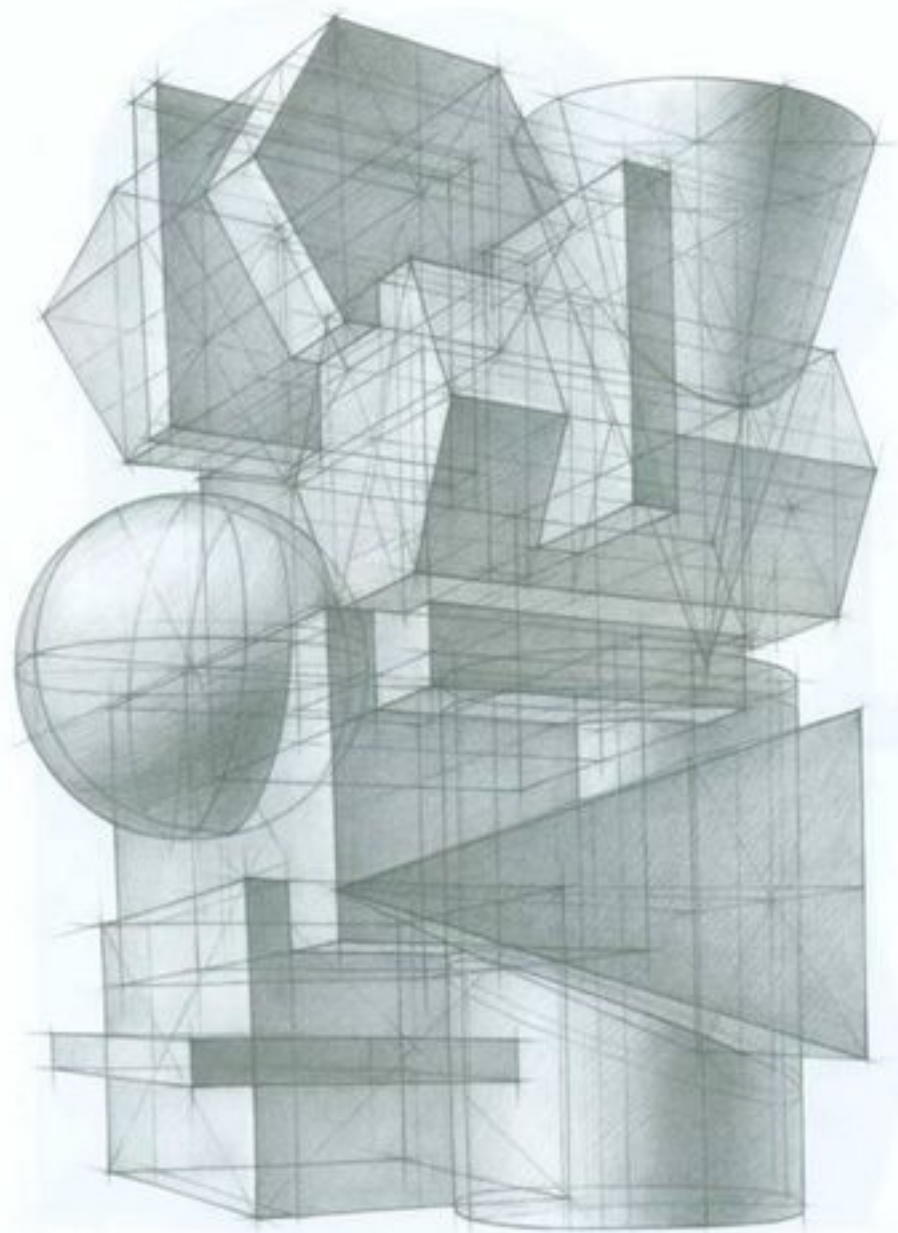

Рис. 6.3

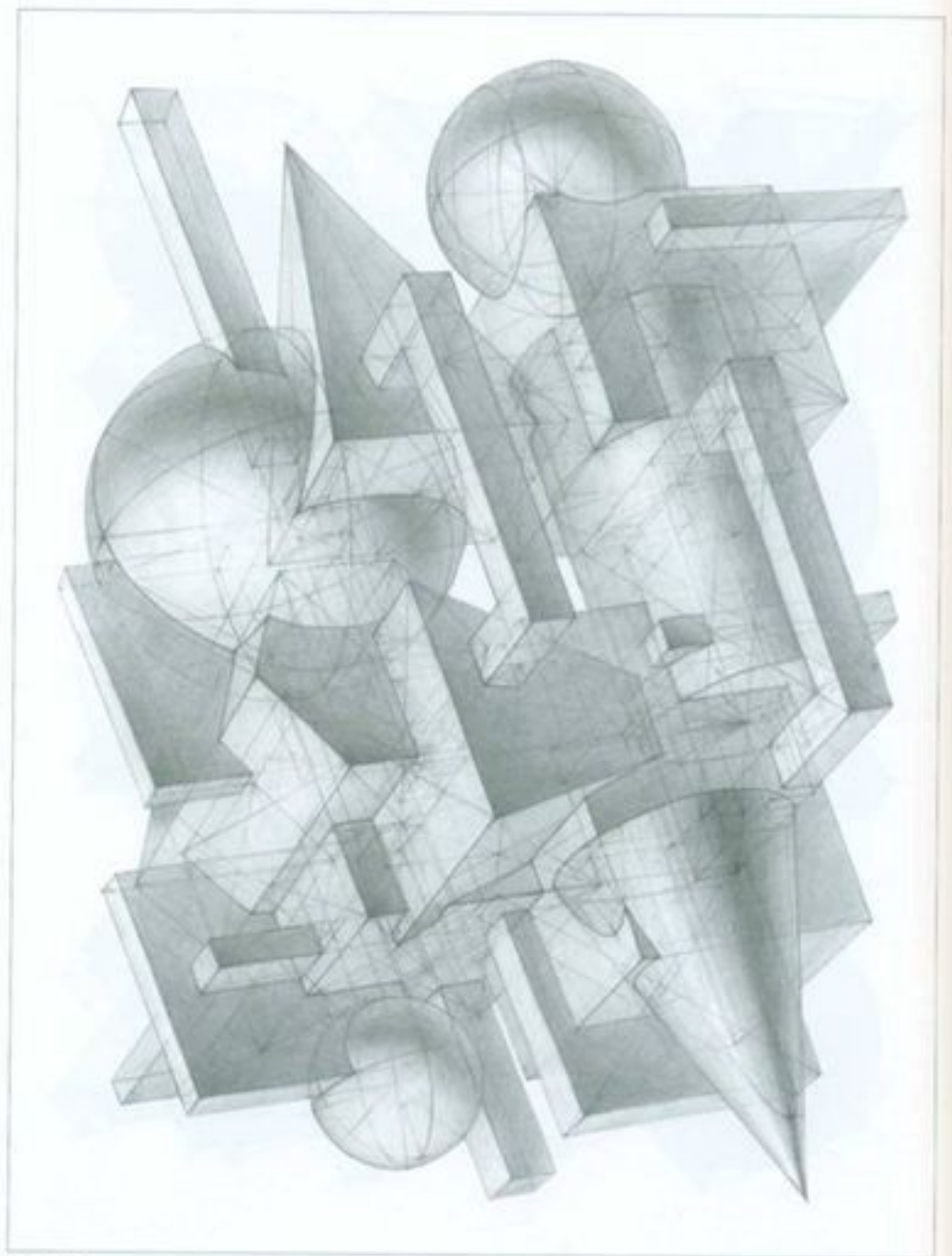
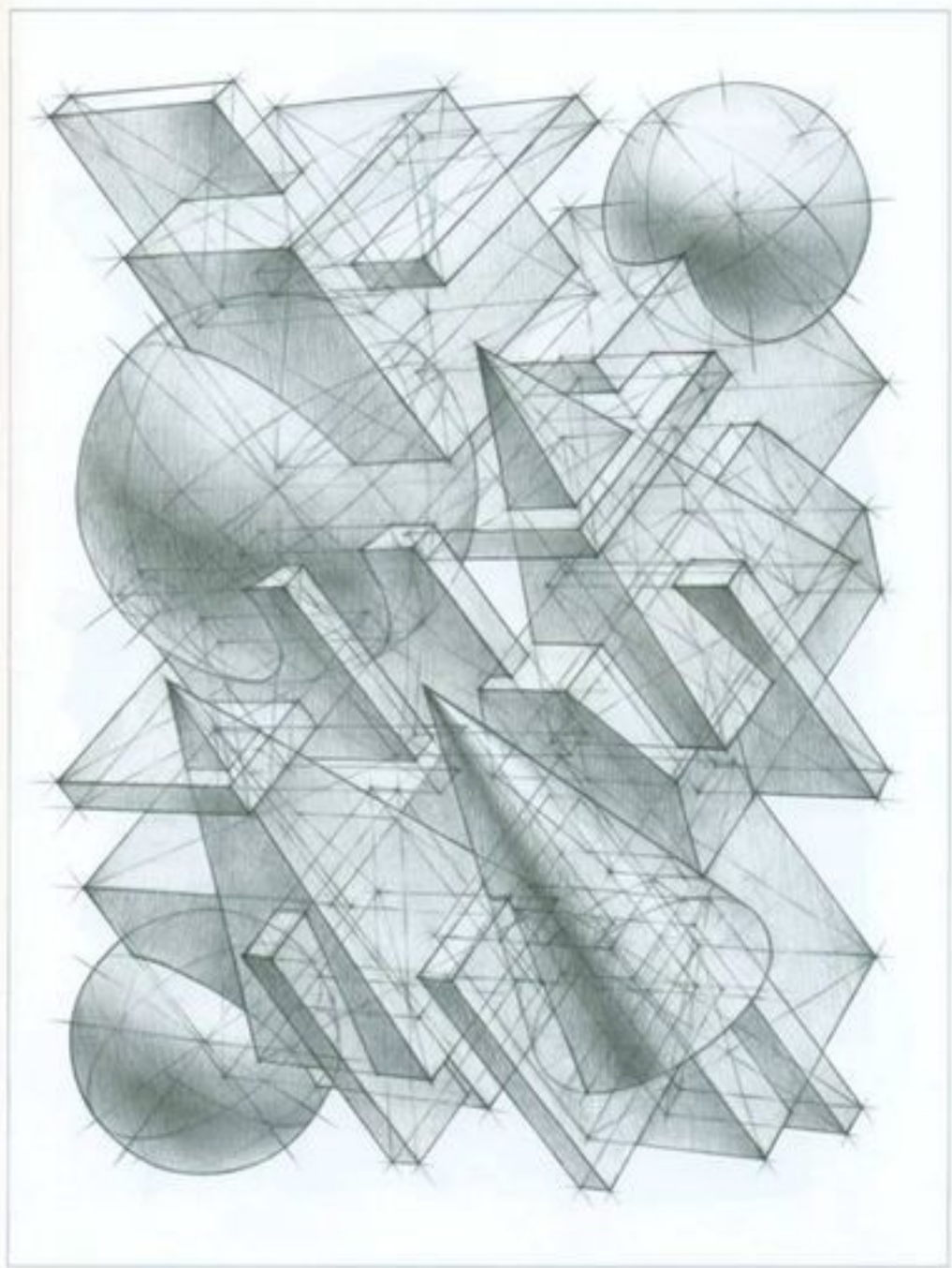
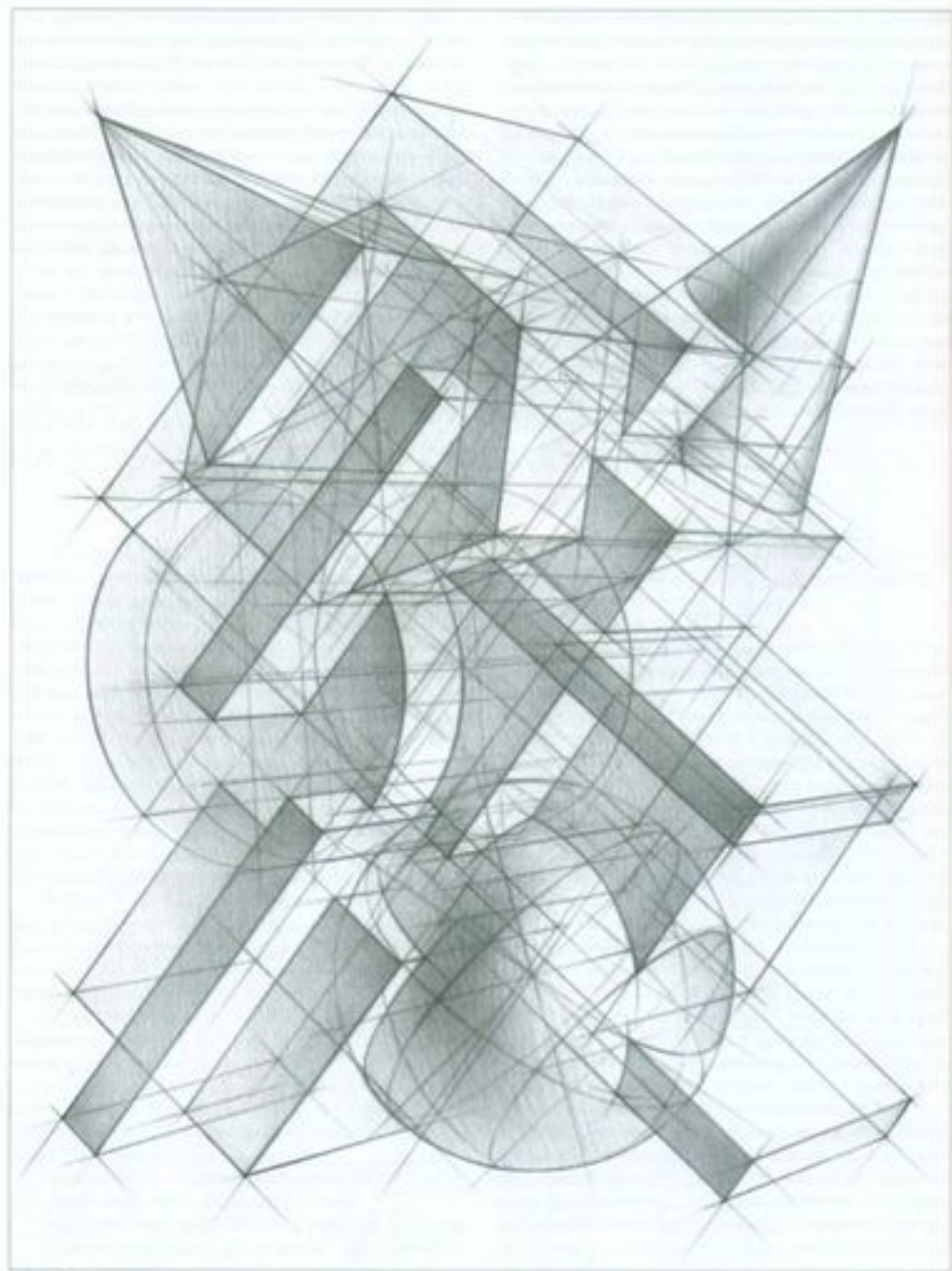

Рис. 6.2