

Digital/Analogue Signal

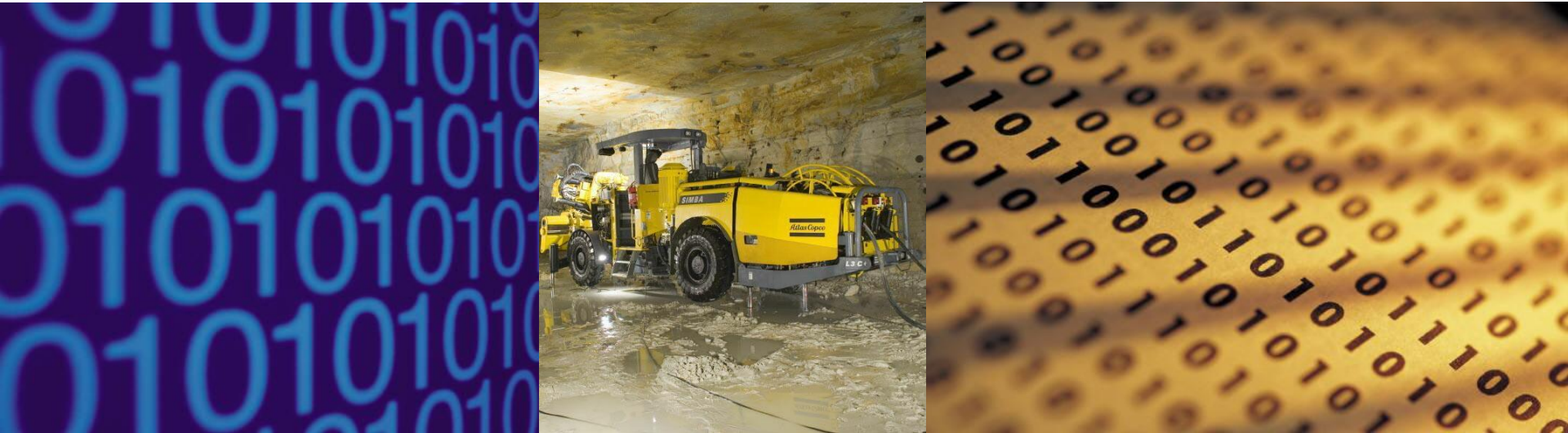

Exercise

Digital/Analogue Signal

New technology

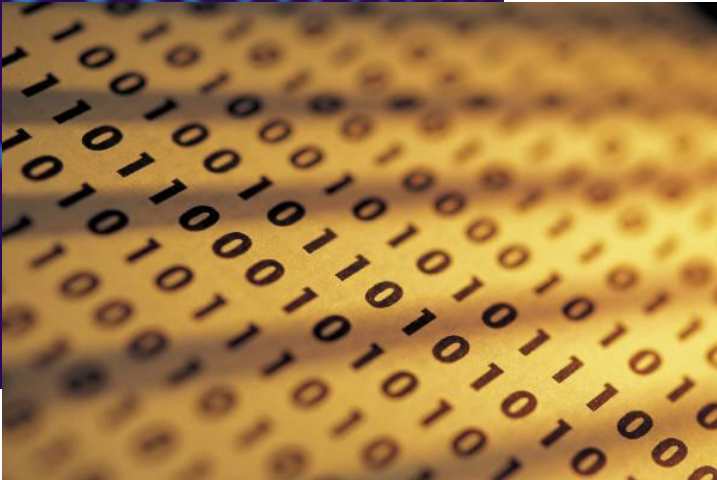

Digital/Analogue Signal

Binary system

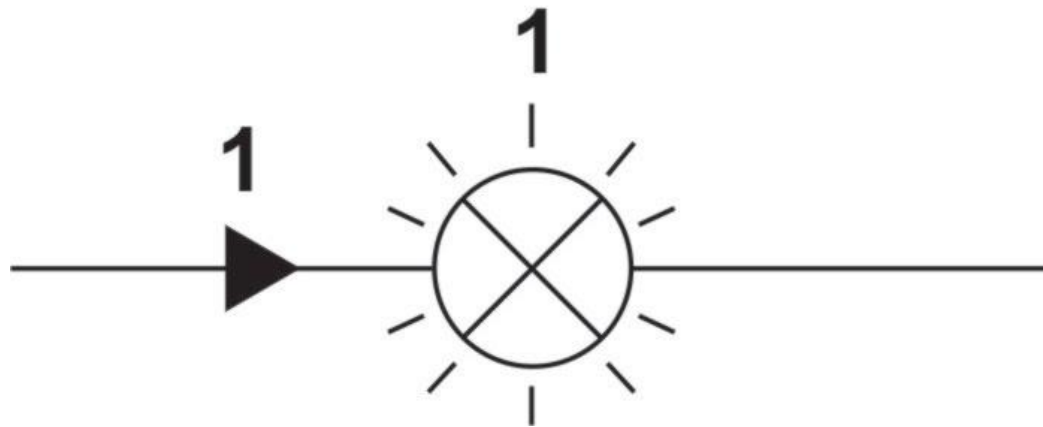
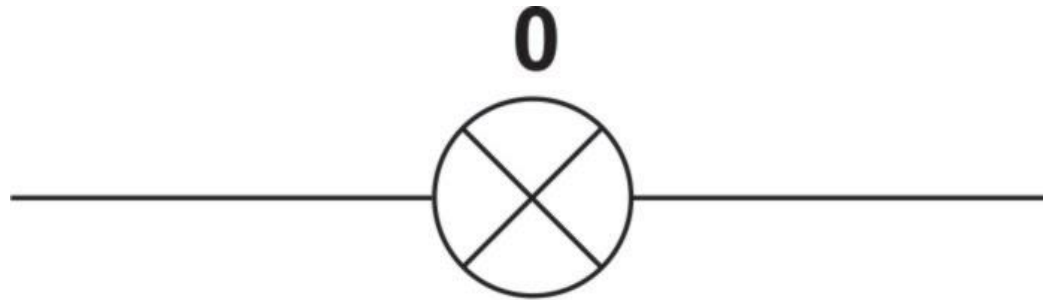

Digital/Analogue Signal

Bit/Byte

Bit/Byte

Digital/Analogue Signal

Digital and analogue

Digital



Analogue



Digital/Analogue Signal

Digital and analogue

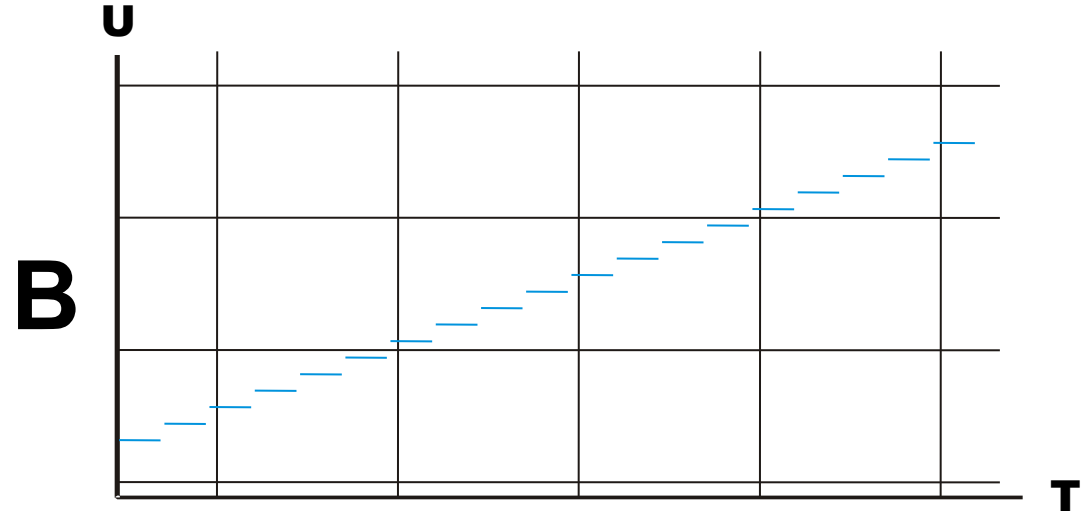
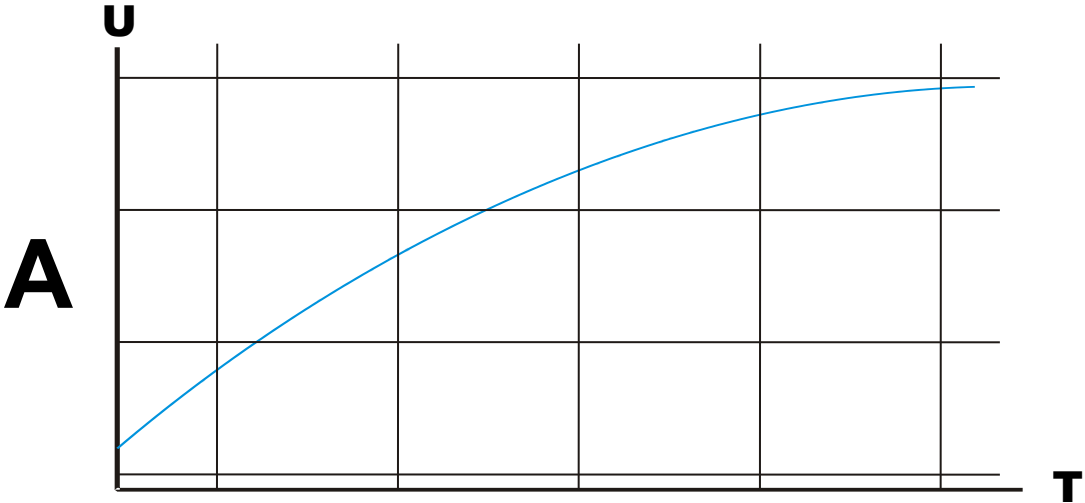

Digital/Analogue Signal

Signals used on the rig

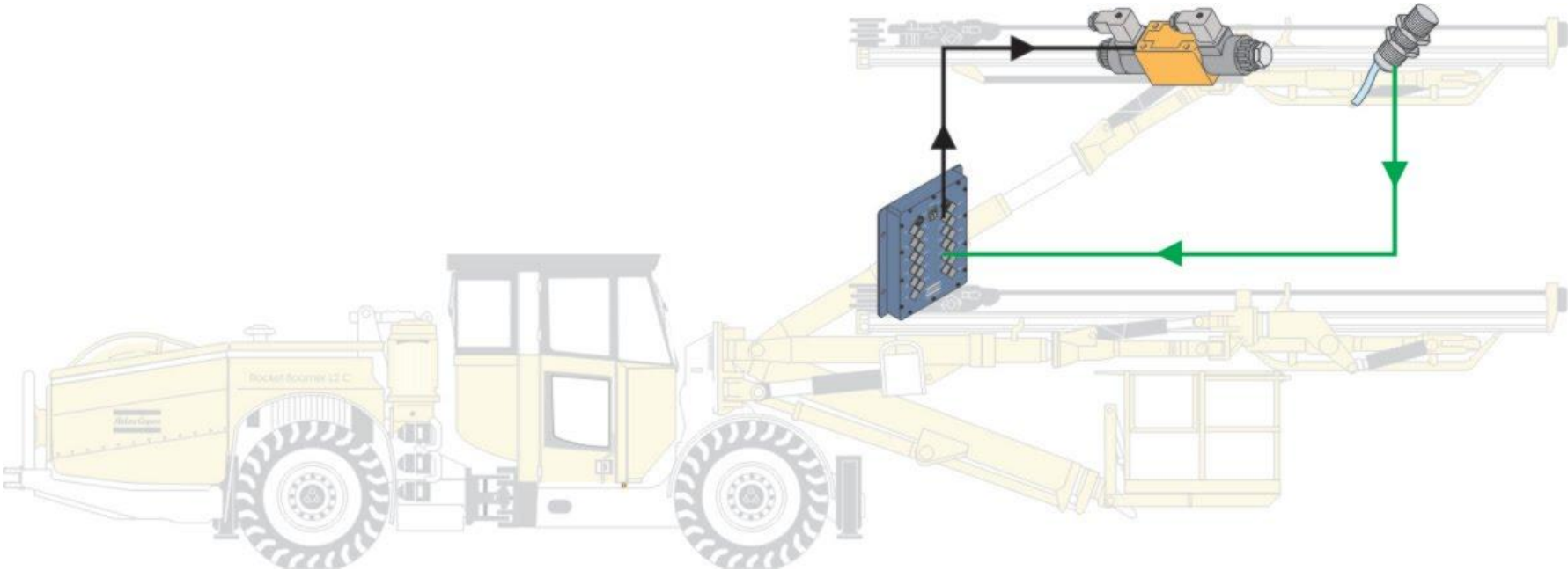

Digital/Analogue Signal

Serial and parallel communication

Serial

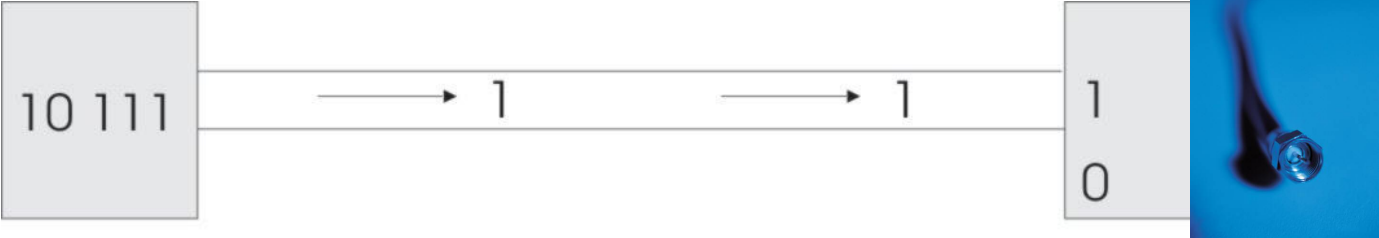

Parallel

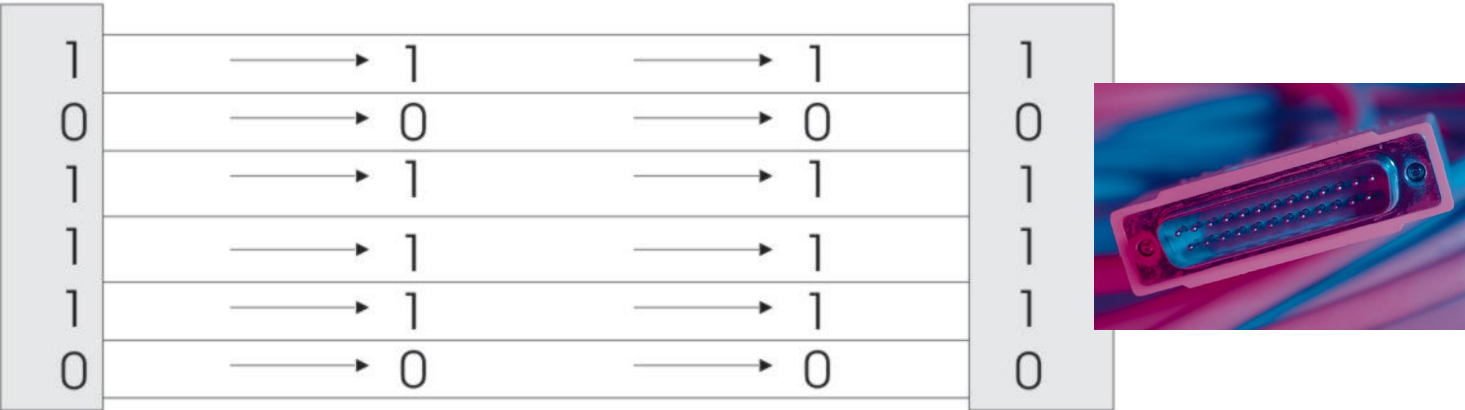

Digital/Analogue Signal

Protocol or standard data transfer

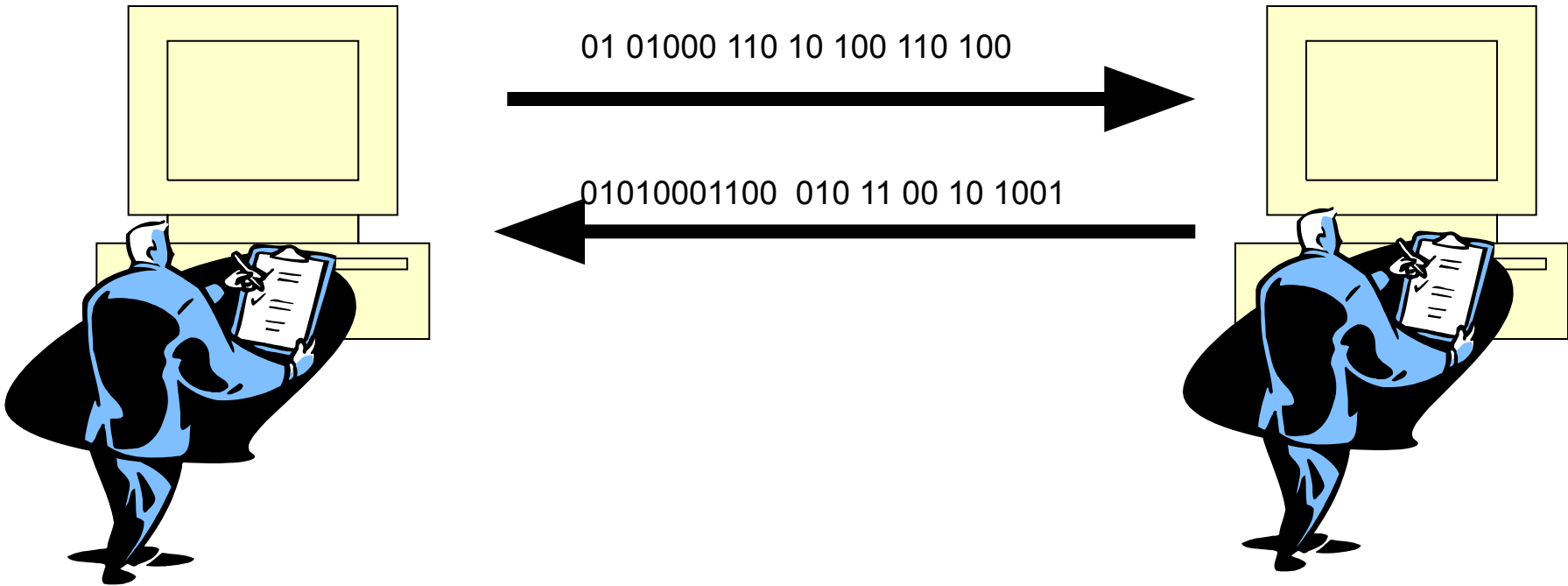

Digital/Analogue Signal

CANBUS

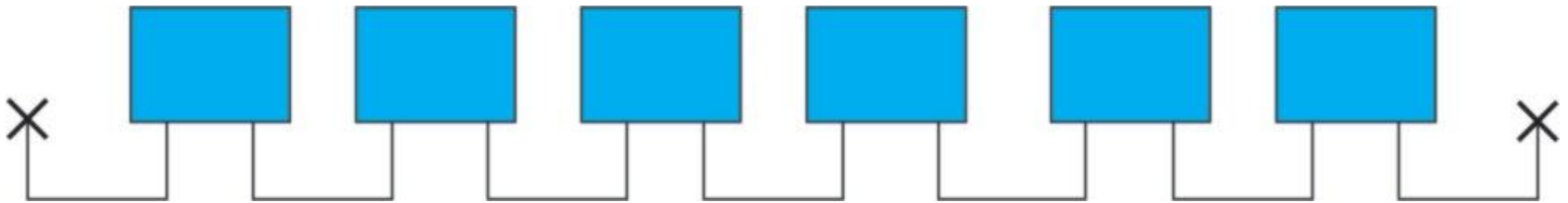

Correct answers

Digital/Analogue Signal

Binary system

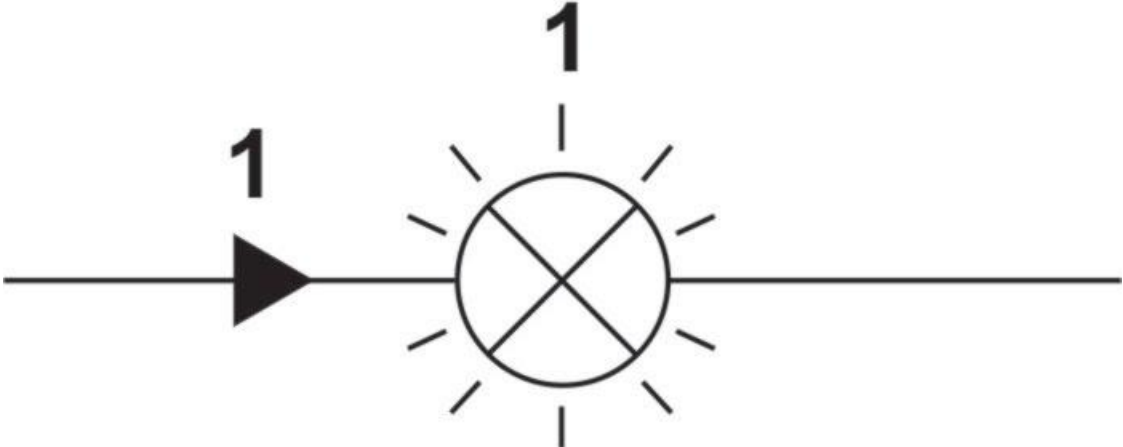
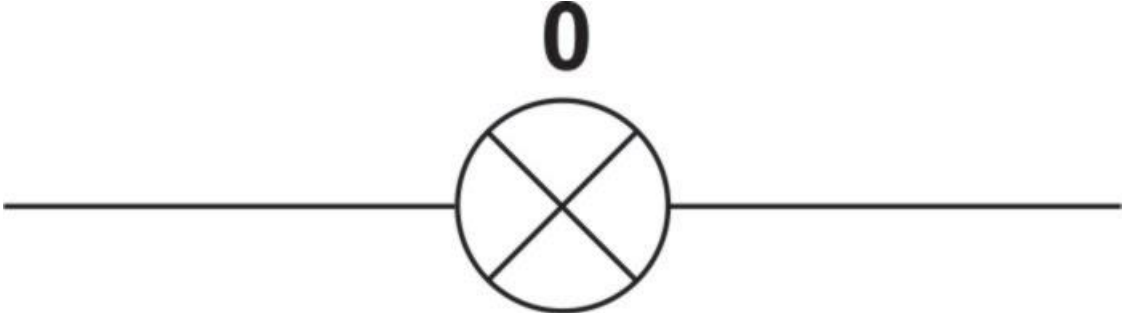

Digital/Analogue Signal

CANBUS

Bit/Byte

Digital/Analogue Signal

Digital and analogue

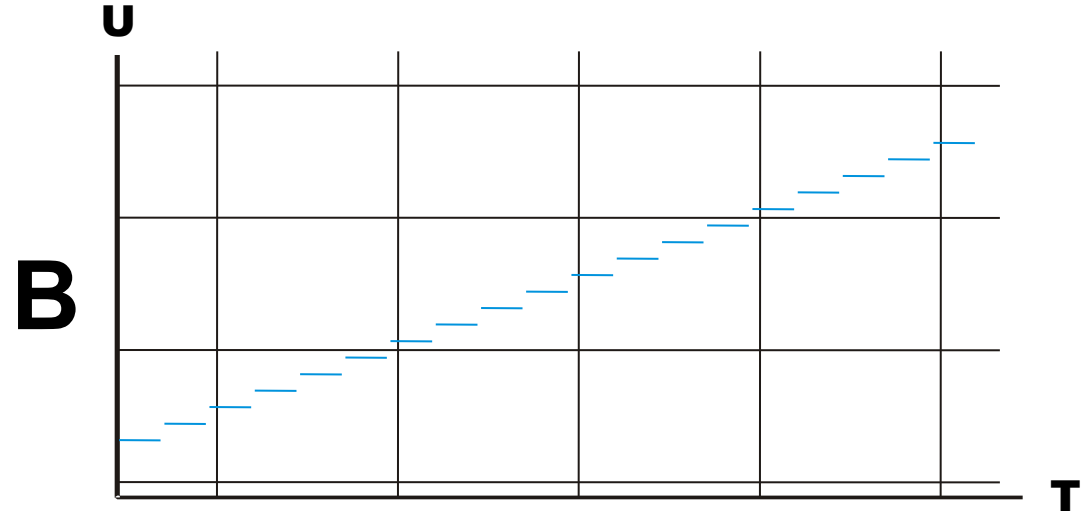
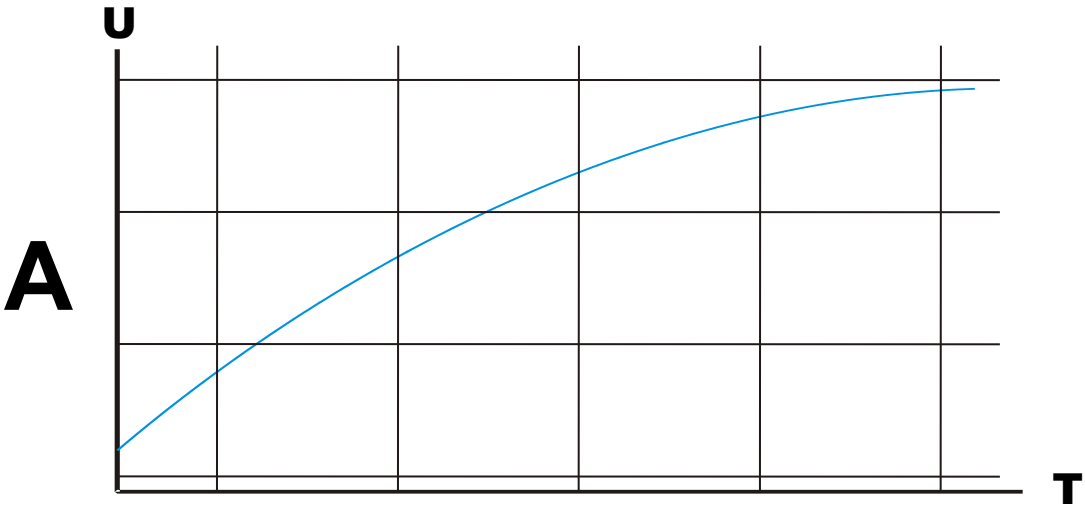

Digital/Analogue Signal

Signals used on the rig

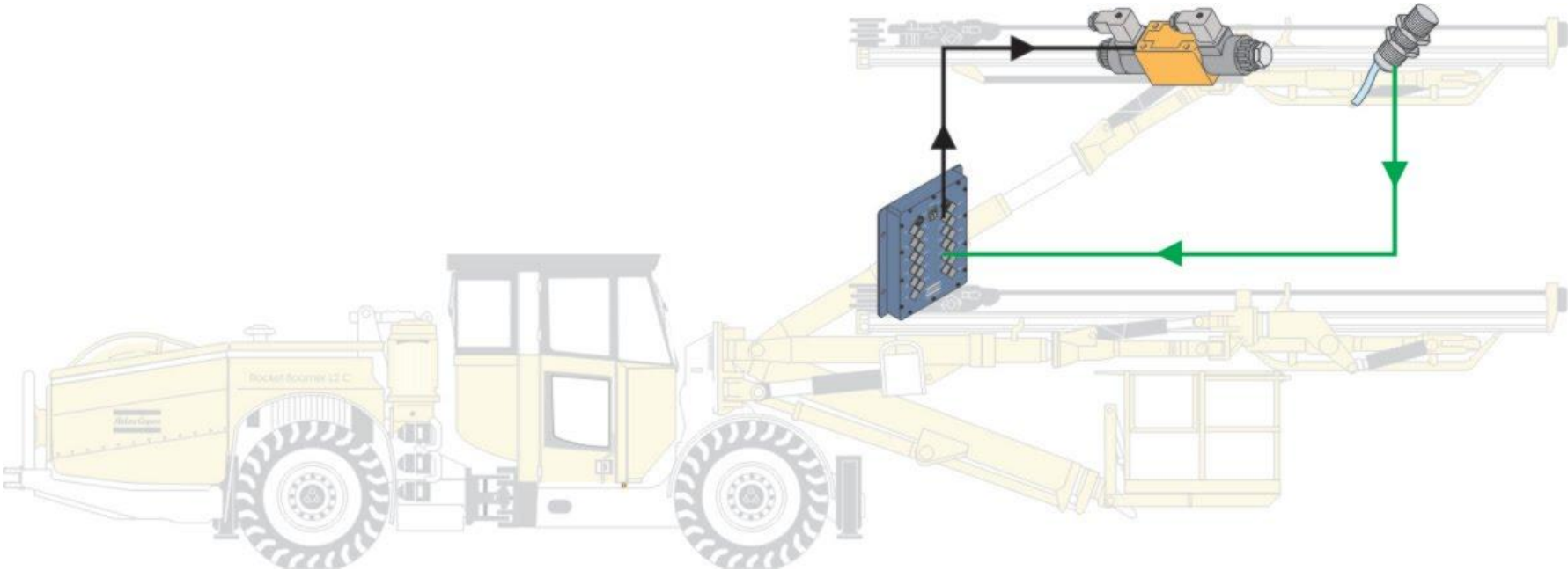

Digital/Analogue Signal

Serial and parallel communication

Serial

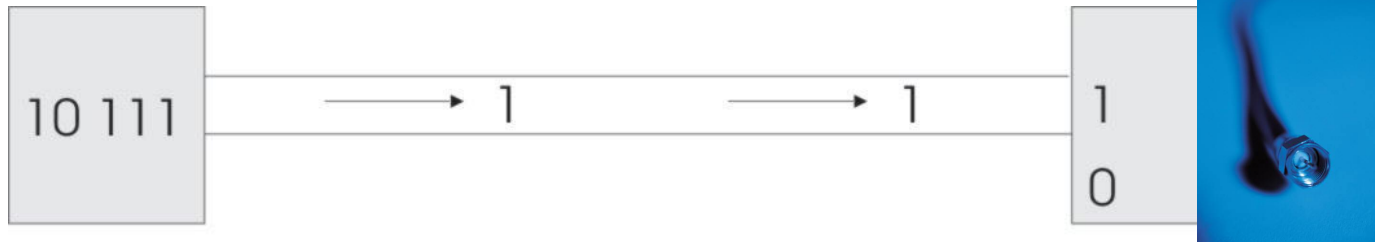

Parallel

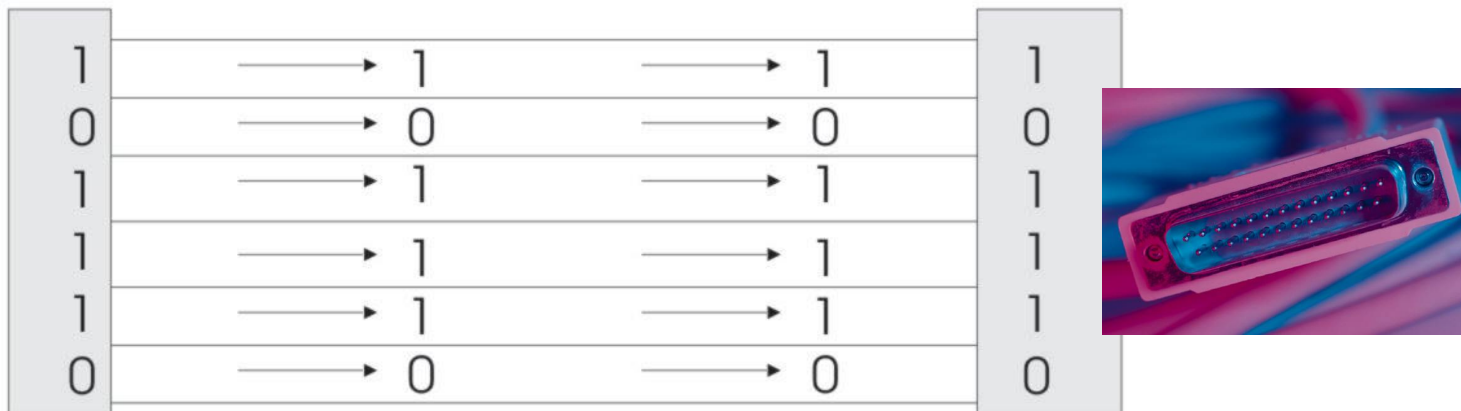

Digital/Analogue Signal

CANBUS

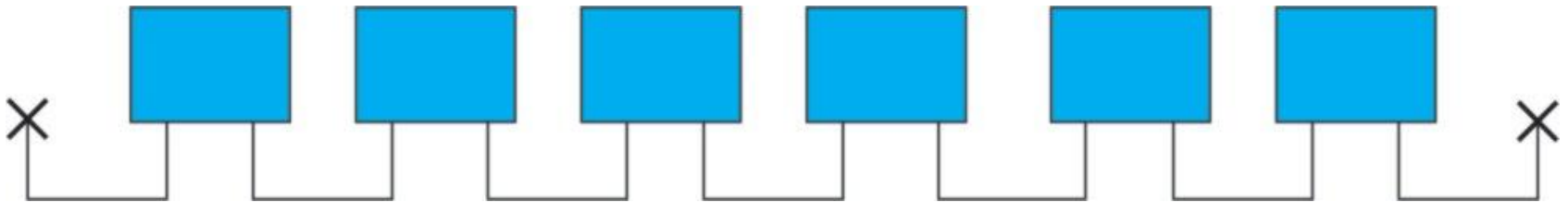

**We are committed to your
superior productivity through
interaction and innovation.**



Atlas Copco

