

Engine Components and Operation

AGME 1613

Fundamentals of Agricultural
Systems Technology

Objectives

- Explain the basic function of an internal combustion engine.
- Describe the five events required for internal combustion engine operation.
- Describe selected individuals and events in the history of engine development.
- Identify and describe the construction and function(s) of primary engine components.
- Explain principles of 2- and 4-stroke cycle engine operation, both S.I. And C.I.

Internal Combustion Engine

- Function - Converts potential chemical energy in fuel into heat energy then to mechanical energy to perform useful work.



Chemical

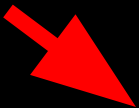

Heat

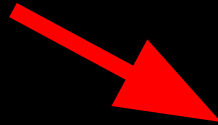

Mechanical

Requirements for I.C. Engine Operation



- **All Internal combustion engines must carry out five events:**
 - **Air-fuel mixture must be brought into the combustion chamber.**
 - **Mixture must be compressed.**
 - **Mixture must be ignited.**
 - **Burning mixture must expand into increasing combustion chamber volume.**
 - **Exhaust gasses must be removed.**

Historical Development of the I.C. Engine

- 1862 -- **Rochas** described the basic principles essential for efficient engine operation.
- 1878 – **Otto** built the first successful 4-stroke cycle engine.
- 1891 – **Day** built an improved 2-stroke cycle engine.
- 1892 – **Diesel** patented the compression-ignition (diesel) engine.
- To present – emphasis on improved engine efficiency, through refinement.

Engine Components and Functions

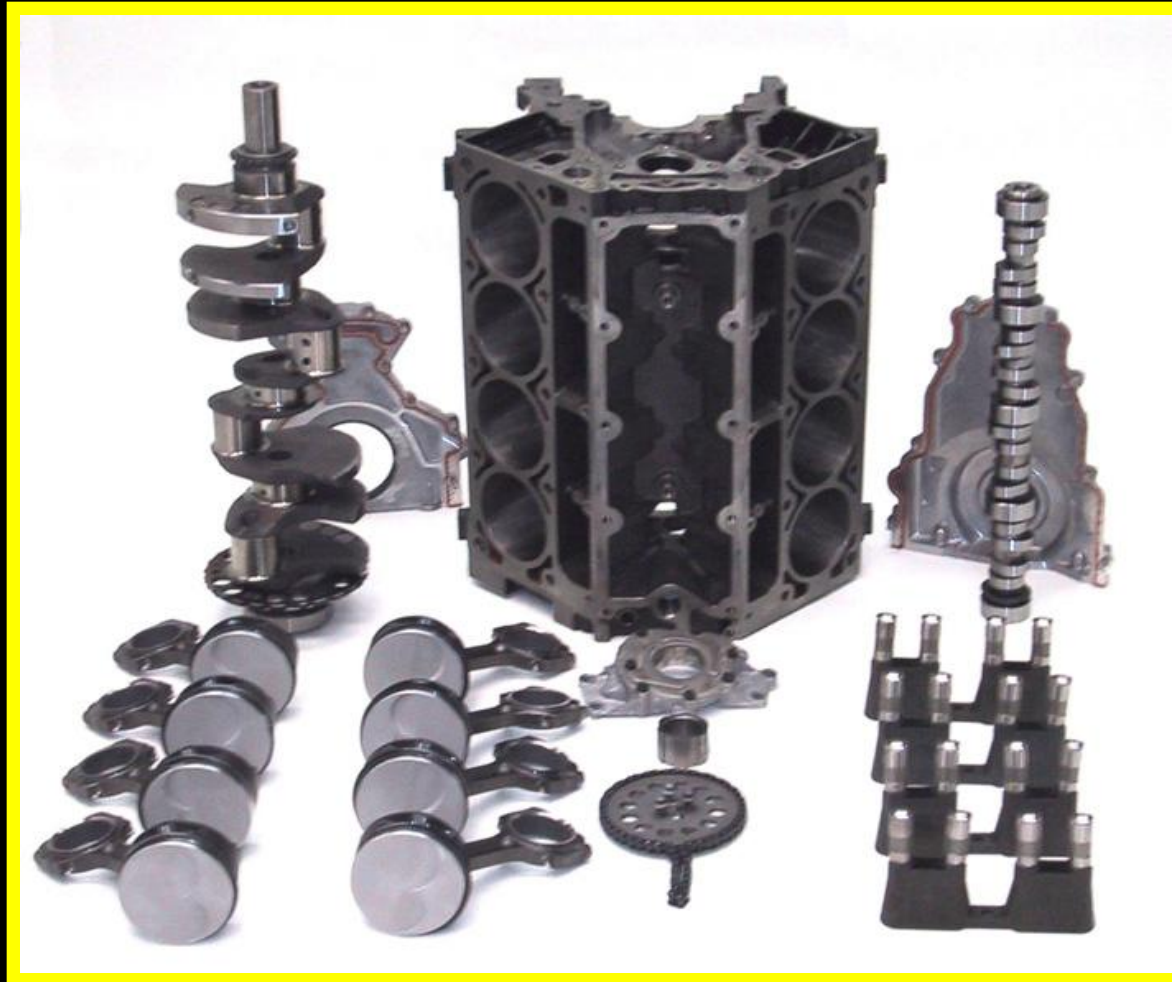

Name that Engine Part

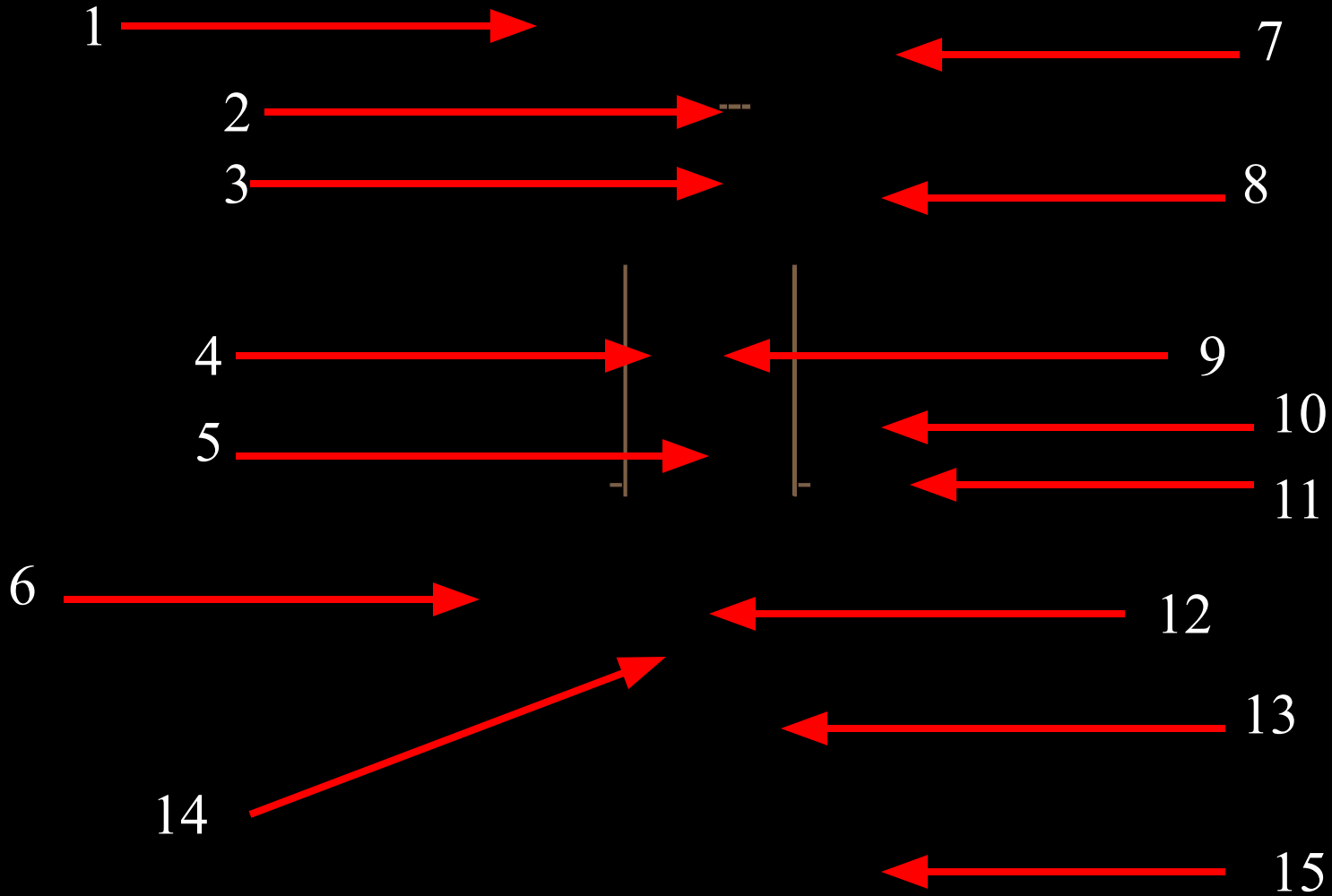

Name that Engine Part

Name that Engine Part

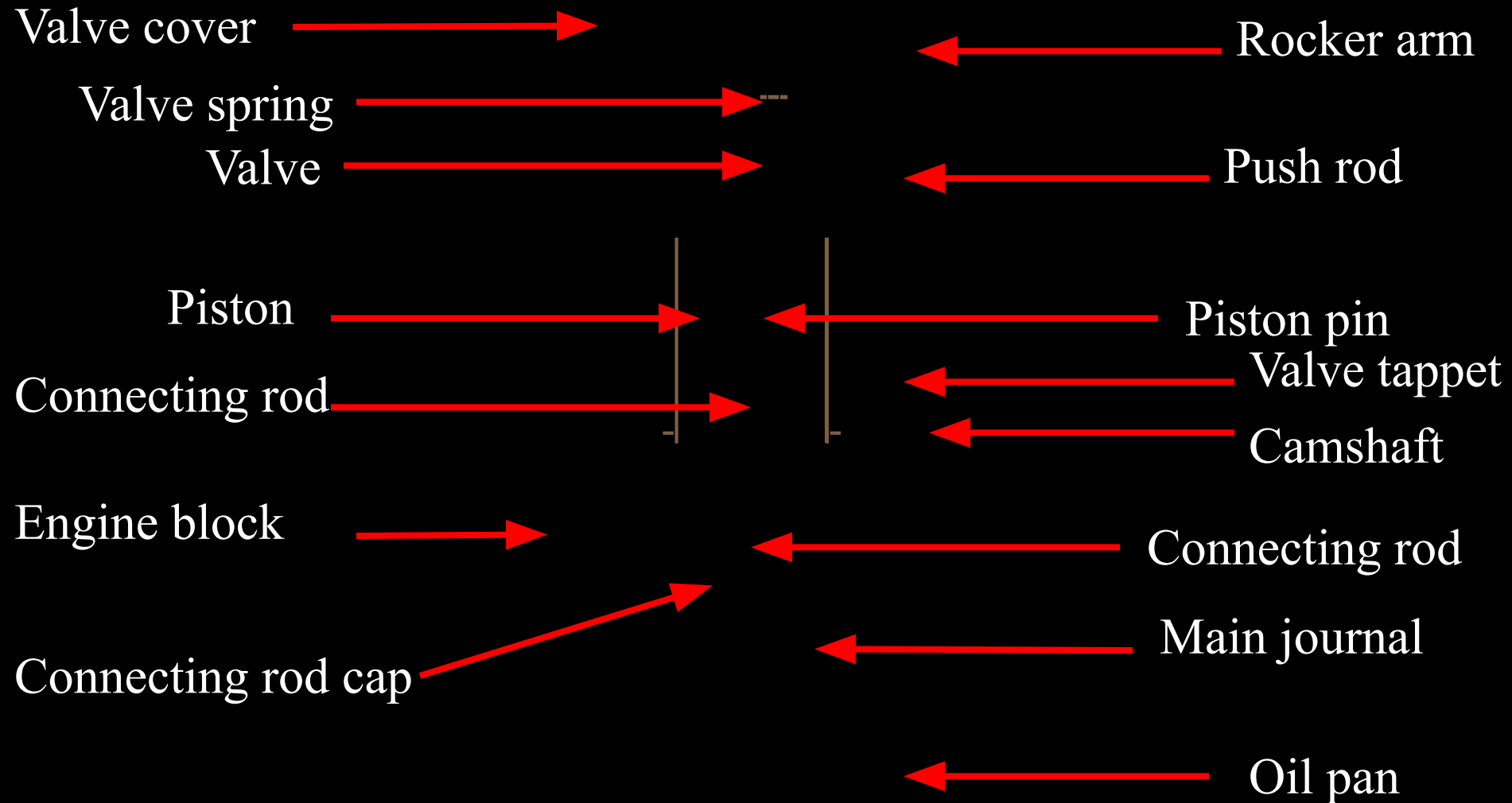

Engine Parts ID Scoring

- 14 - 15 correct – Master Gearhead
- 12-13 – Gearhead
- 10 -11 – Mechanic
- 8 - 9 -- Apprentice Mechanic
- 6 – 7 – Wrench Turner
- 4 – 5 – Wrench Loser
- 2 -- 3 – Jiffy Lube Customer
- 0 – 1 Can't Find Jiffy Lube
 - Looking for Lube in all the Wrong places????

Cylinder Block

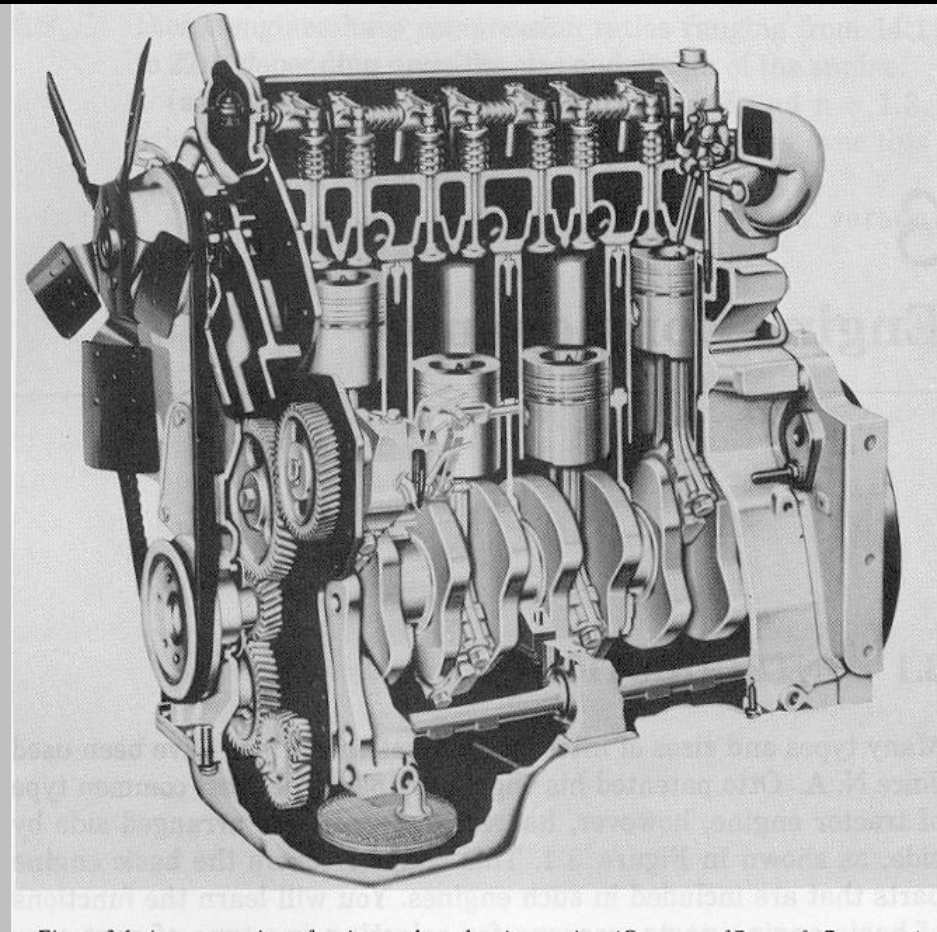

- “Backbone” of the engine.
 - Supports / aligns most other components.
 - Part of basic tractor frame.
- Contains:
 - **Cylinders**
 - Coolant passages
 - Oil passages
 - Bearings
- One-piece, gray cast iron

Cylinders

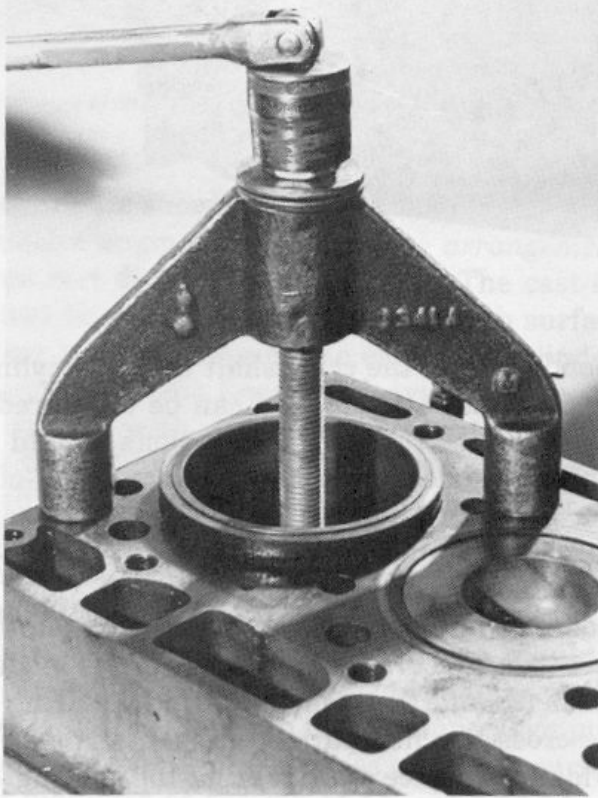
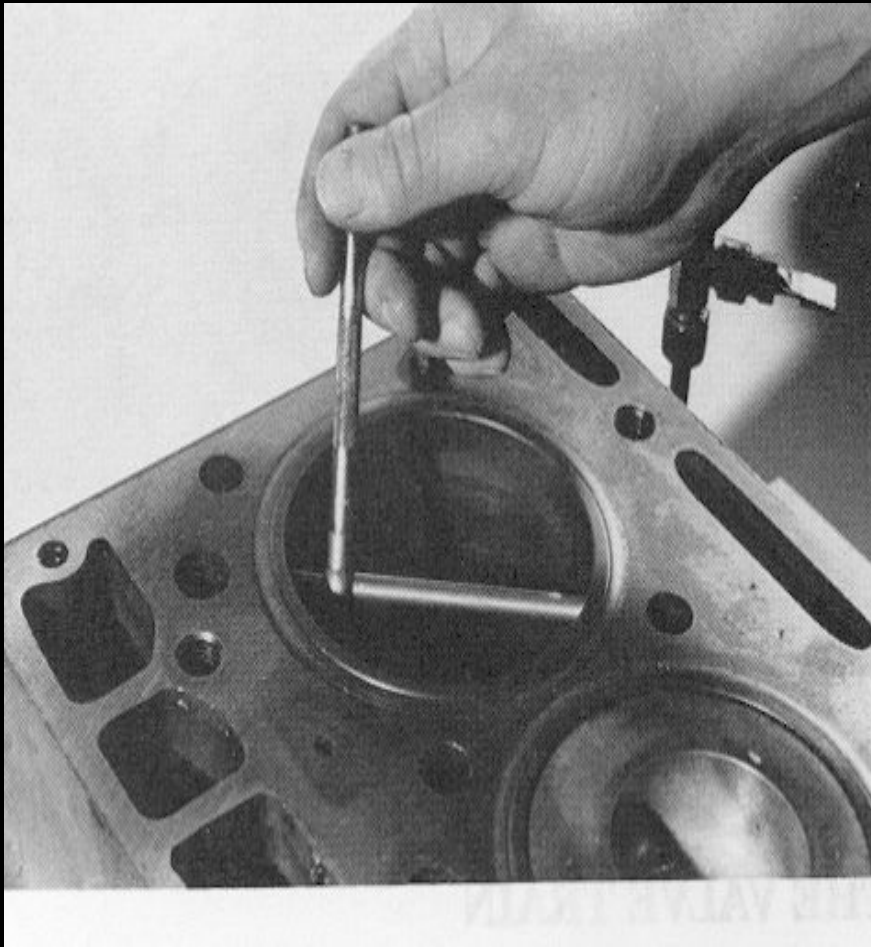

Figure 3.4—Removal of a cylinder liner. (Photo by Laurie Goering.)

- Cylindrical holes in which the pistons reciprocate.
- May be:
 - Enblock
 - Liners
 - Wet liners
 - Dry liners
- Cylinder bore — diameter of cylinder

Checking Cylinder Condition



- During engine overhaul, cylinder is checked for:
 - Excessive wear (oversize)
 - Out-of Round
 - Taper

Bearings and Journals

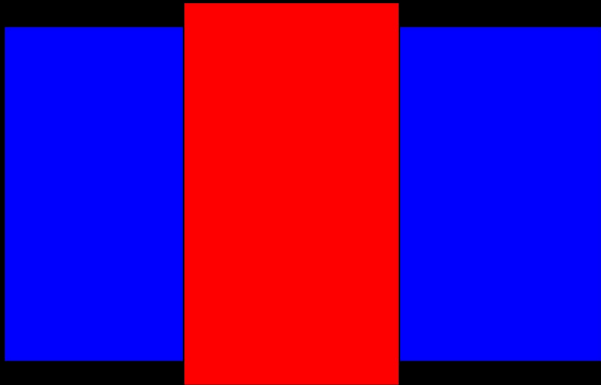
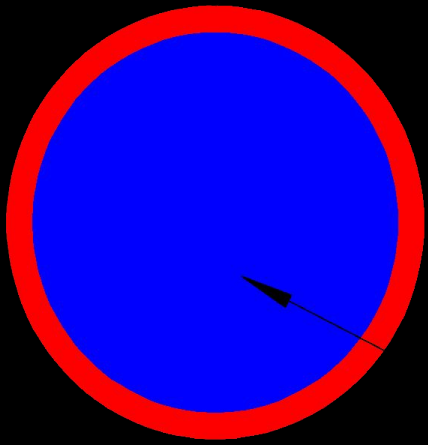

- Bearing – Stationary (non-rotating) surfaces providing support to moving (rotating) component.
 - Main bearings
 - Rod bearings
 - Cam bearings
- Journal – Surface of moving component supported by a bearing.

Cylinder Head

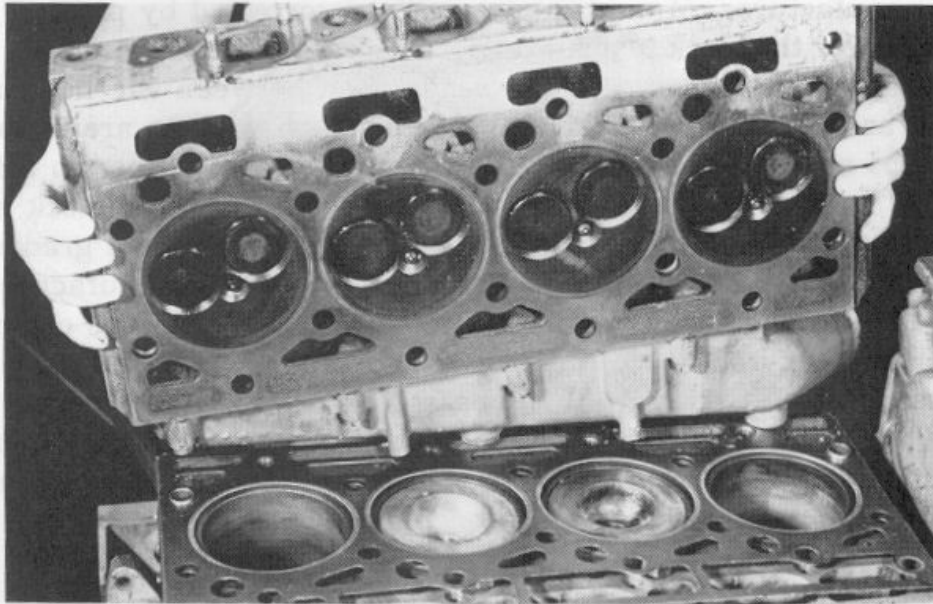

- One-piece castings of iron alloy.
- Seals the “top-end” of the combustion chamber.
- Contains the valves and the intake and exhaust “ports”.
- Head bolts and head gasket ensure air-tight seal of the combustion chamber.
- Contains oil and coolant passages.

Valve Train

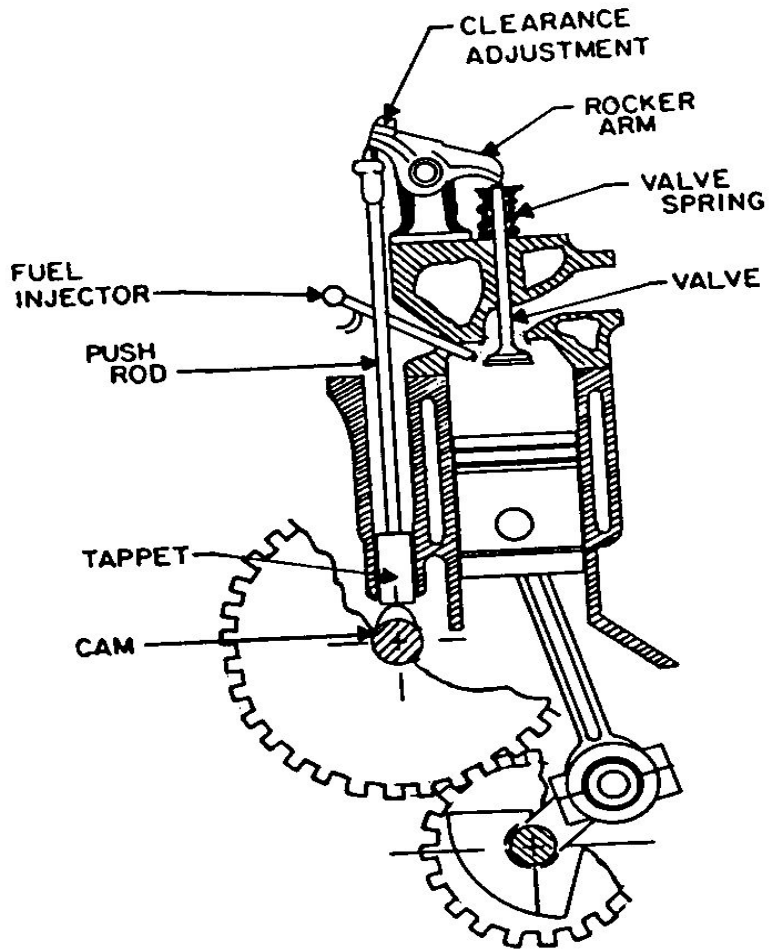

- Controls flow into and out of the combustion chamber.
 - Time and Duration
- Tractor engines use “Overhead Valve (OHV)” configuration.
- Components
 - Camshaft
 - Valve tappets
 - Push rods
 - Rocker arm
 - Valves
 - Valve springs
 - Valve rotators
 - Valve seats

Camshaft

- **Open the intake and exhaust valves at correct time and for correct duration.**
- **Driven by gear (or chain) from the crankshaft.**
- **2:1 crankshaft to camshaft gear ratio.**

Cam Profile



Valves

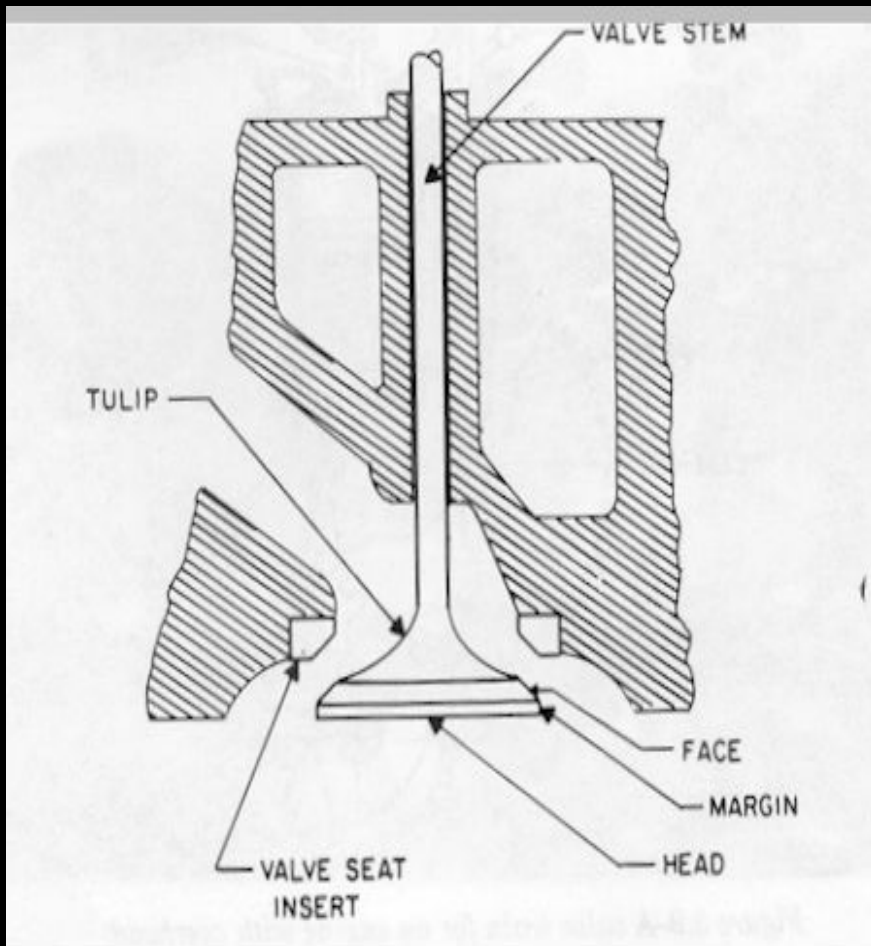

- Each cylinder will have:
 - Intake valve
 - Exhaust valve
- **Valve nomenclature**
 - Head
 - Margin
 - Face
 - Tulip
 - Stem

Piston and Rings



- Piston
 - Forms the “moveable bottom’ of the combustion chamber.
 - Iron alloy or aluminum
- Rings
 - Compression
 - Oil-control
 - Cast iron
- Piston pin

Know Your Piston!

Piston Nomenclature

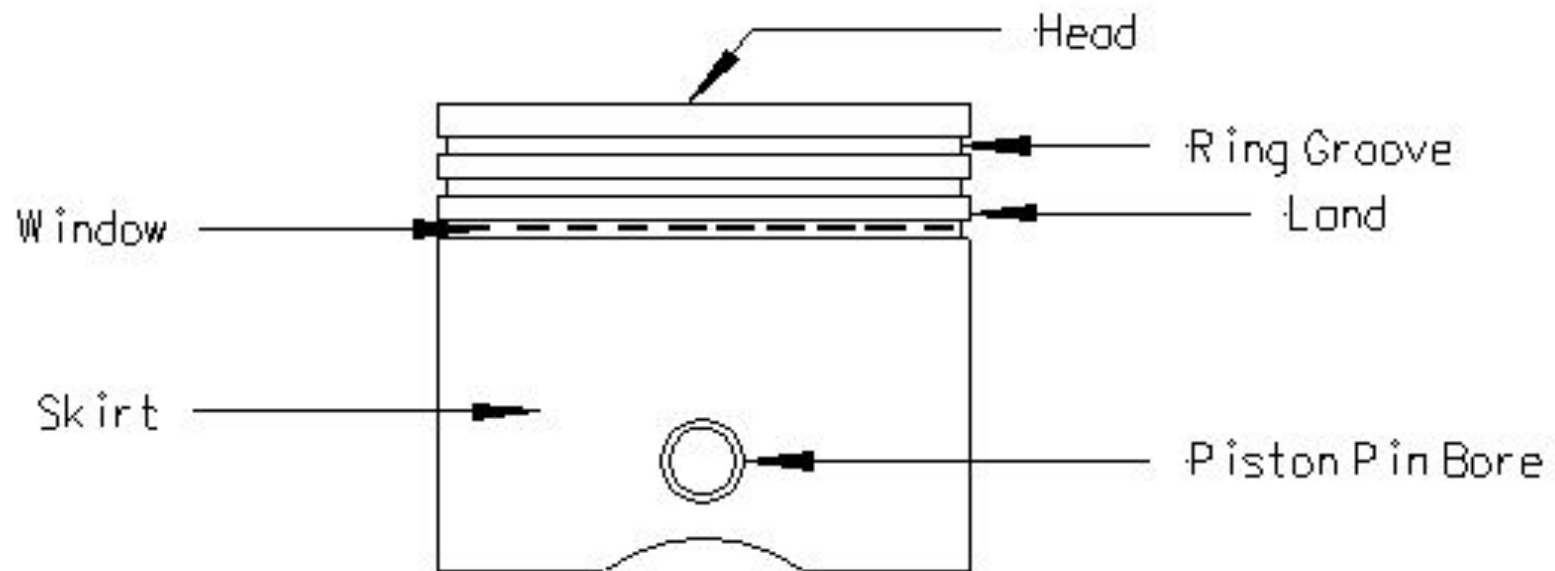

Connecting rod

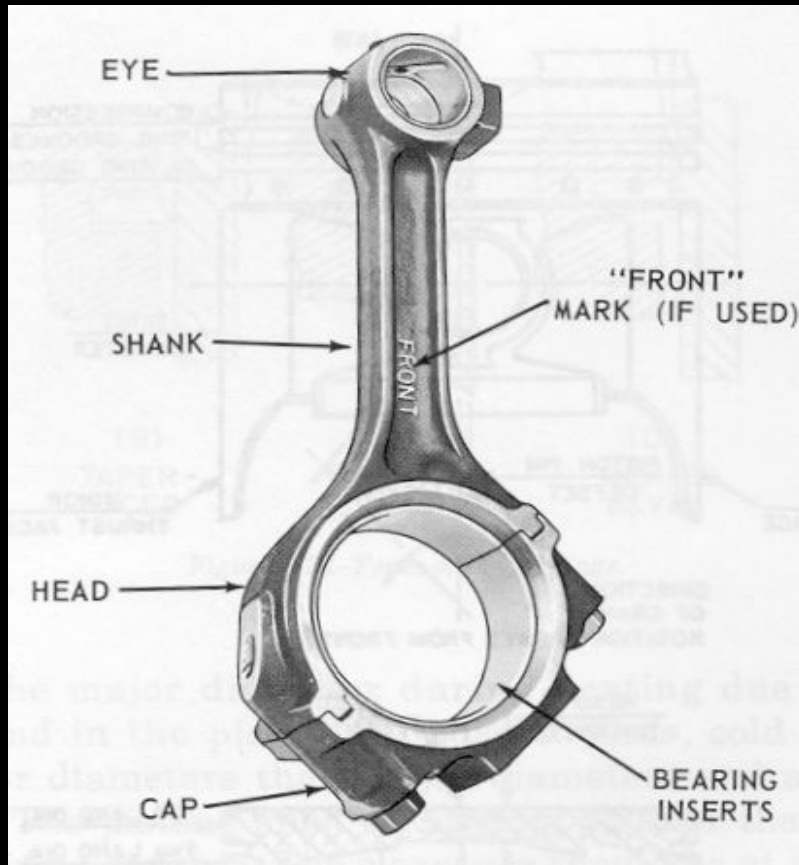

- Connects the piston to the crankshaft
- Converts reciprocating piston motion to rotary motion at the crankshaft.
- Nomenclature
- Drop-forged steel

Crankshaft

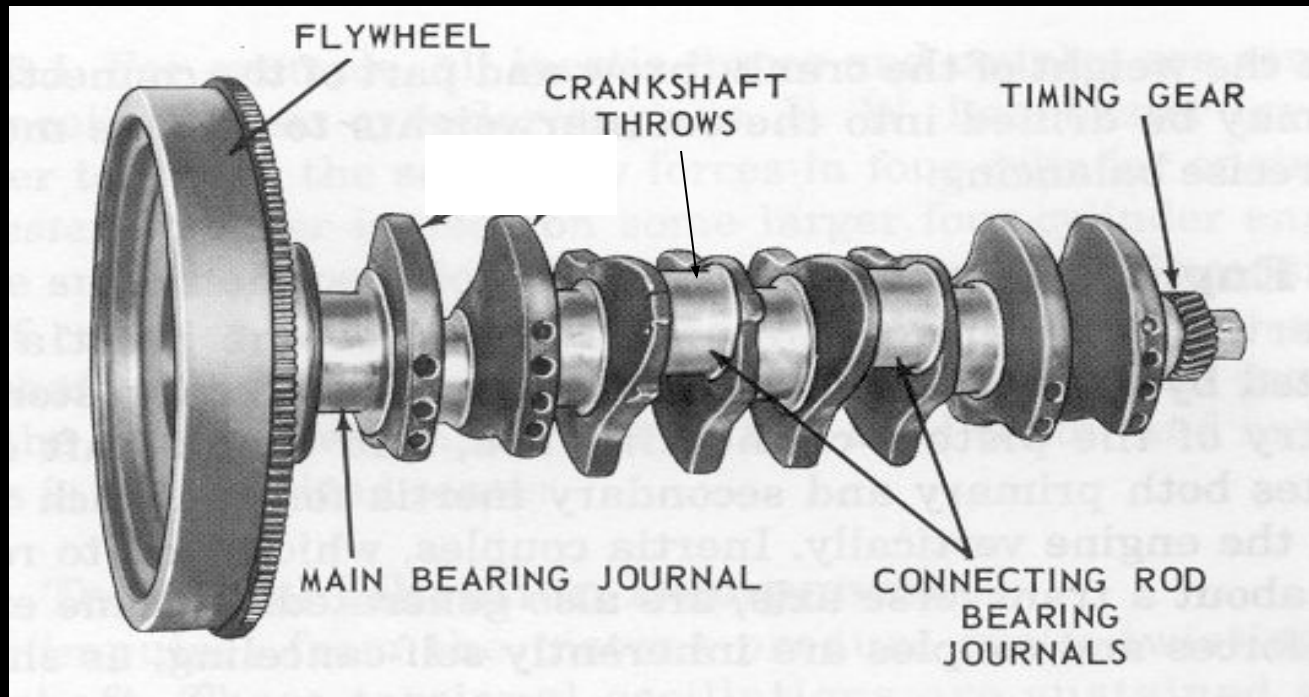

- Works with connecting rod to change reciprocating to rotary motion.
- Transmits mechanical energy from the engine.
- Made of heat-treated steel alloys.

Cylinder Bore

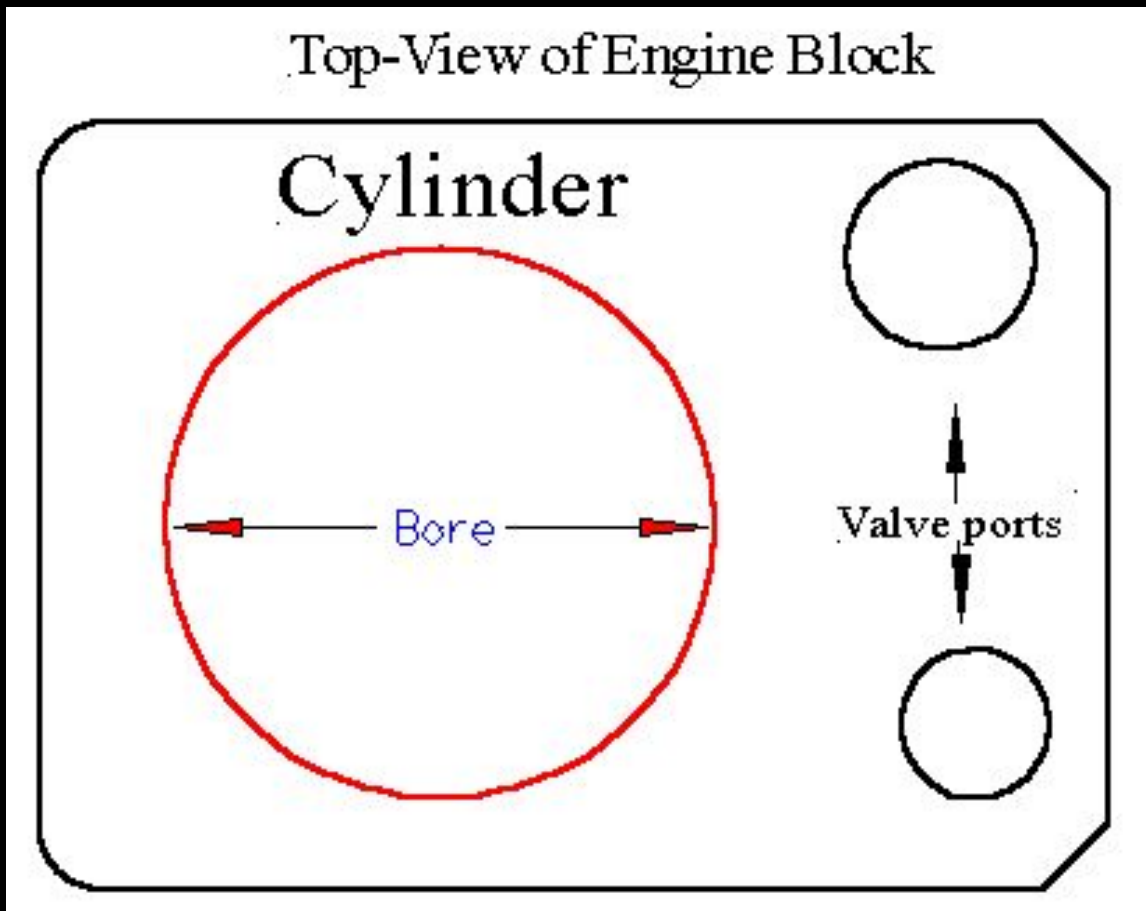

- Bore is the diameter of the cylinder

Stroke

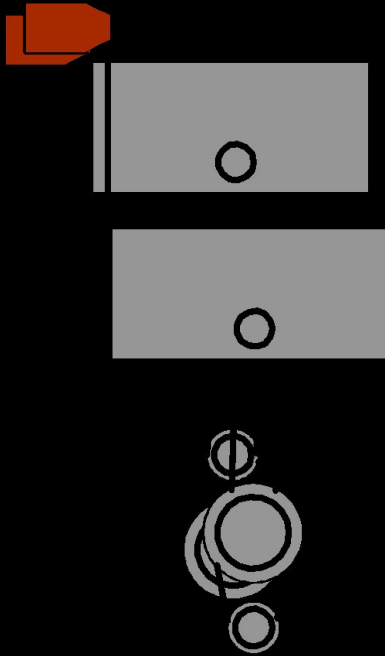

- Linear distance piston travels from Top Dead Center (TDC) to Bottom Dead Center (BDC).

Piston and Engine Displacement

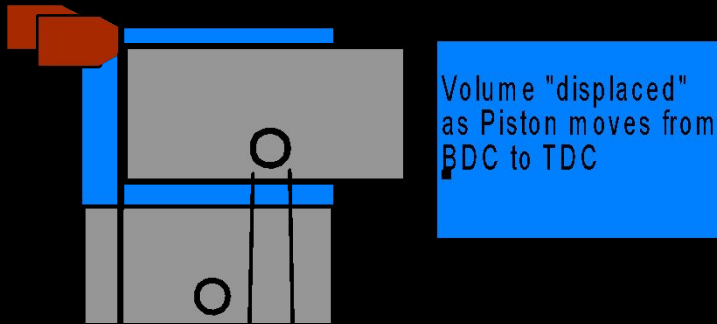

- $Pd = (B^2 \times \pi \times s) / 4$
- $Ed = [(B^2 \times \pi \times s) / 4] \times n$

Compression Ratio

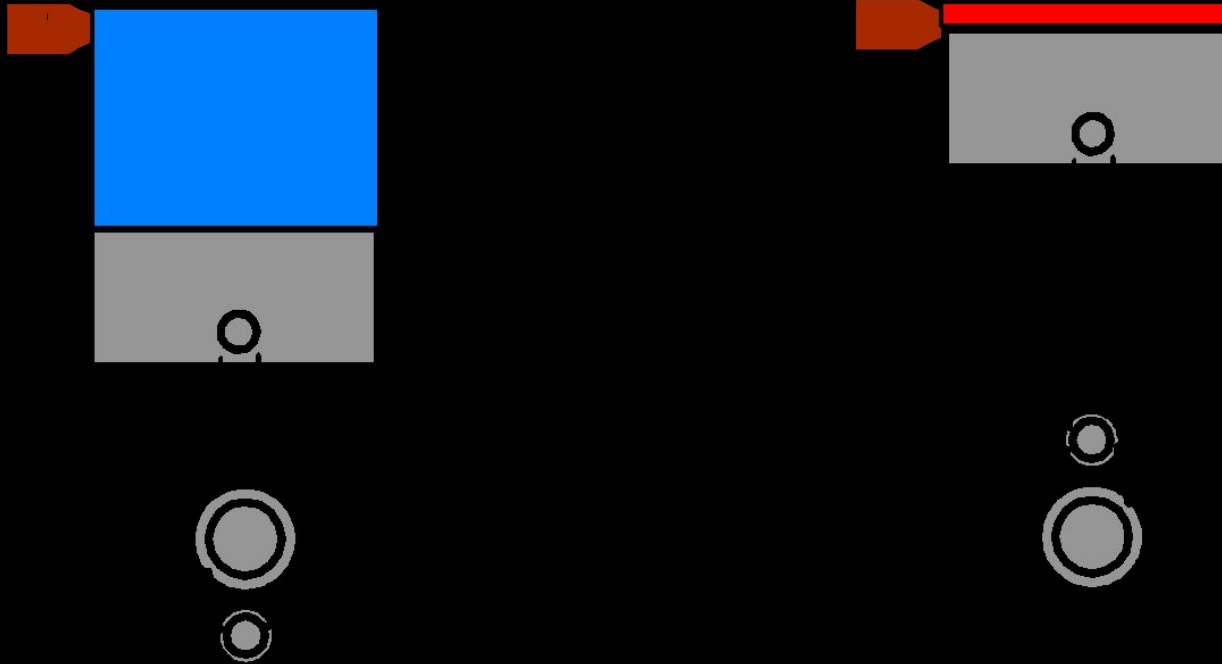

- Ratio of “Total Volume” in cylinder at BDC to TDC.
- C.R. = $(P_d + C_{IV}) / C_{IV}$

Compression Ratio and Gasoline Octane Rating

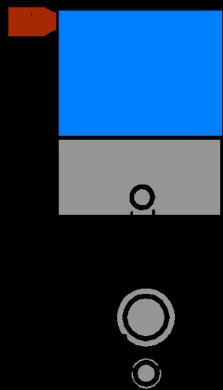
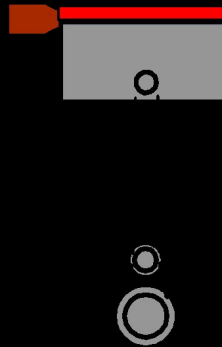
	<u>CR</u>	<u>Octane Rating</u>
	•5:1	73
	•6:1	81
	•7:1	87
	•8:1	91
	•10:1	98
	•11:1	100
	•12:1	102

Compression Ratio and Theoretical Otto Cycle Efficiency

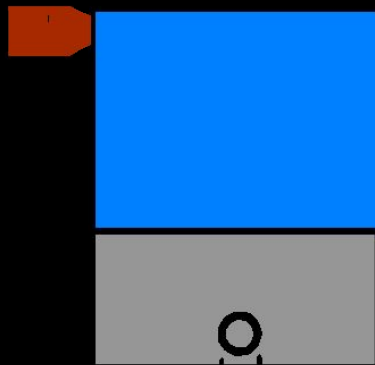

4-Stroke Cycle Engine Operation

- 
- 4-stroke cycle engines require four strokes of the piston to complete the five events necessary for engine operation.
 - 1 piston stroke = $\frac{1}{2}$ crankshaft revolution.
 - 4 piston strokes = 2 crankshaft revolutions.

4-Stroke Cycle Engine Operation

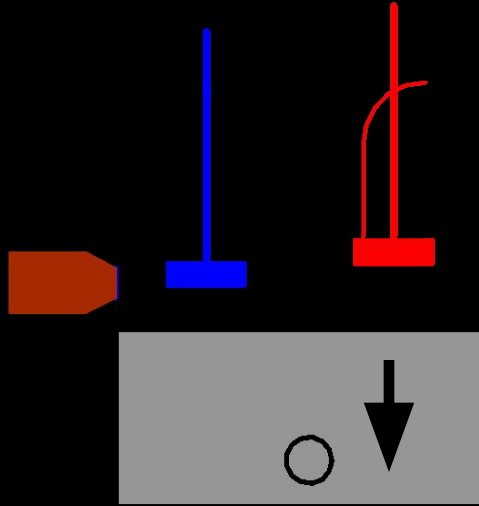

- Intake Stroke
 - Intake valve open.
 - Piston moves down (TDC to BDC) in cylinder.
 - Low pressure is created in cylinder.
 - Air is brought into the combustion chamber due to pressure differences.

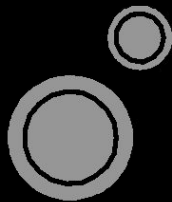

4-Stroke Cycle Engine Operation

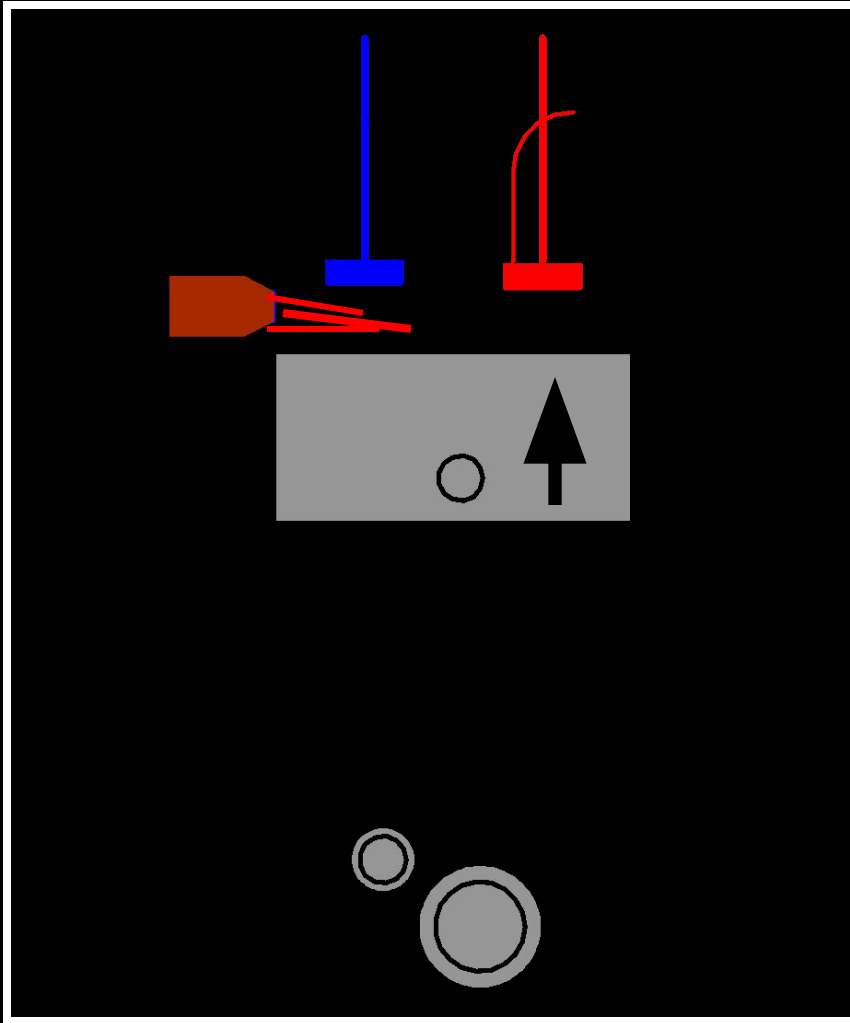

- **Compression Stroke**
 - **Both valves closed.**
 - **Piston moves from BDC to TDC**
 - **Air in combustion chamber is compressed, raising its temperature.**
 - **Near TDC of Compression stroke, diesel fuel is injected into the combustion chamber.**

4-Stroke Cycle Engine Operation

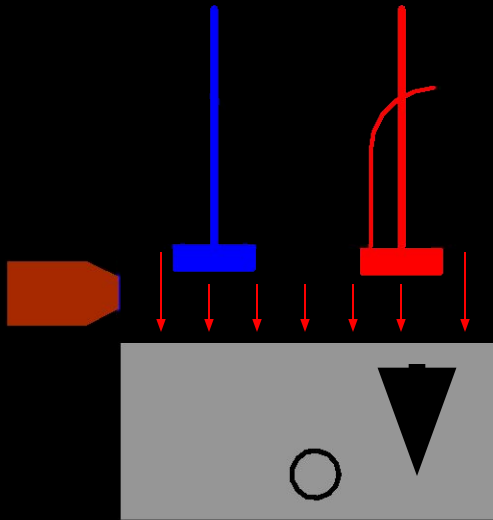

- Power Stroke
 - Both valves are closed
 - Air-fuel mixture burns rapidly
 - Expansion of the burning air-fuel mix applies force to the head of the piston
 - Piston is driven down in the cylinder.

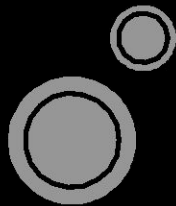

4-Stroke Cycle Engine Operation

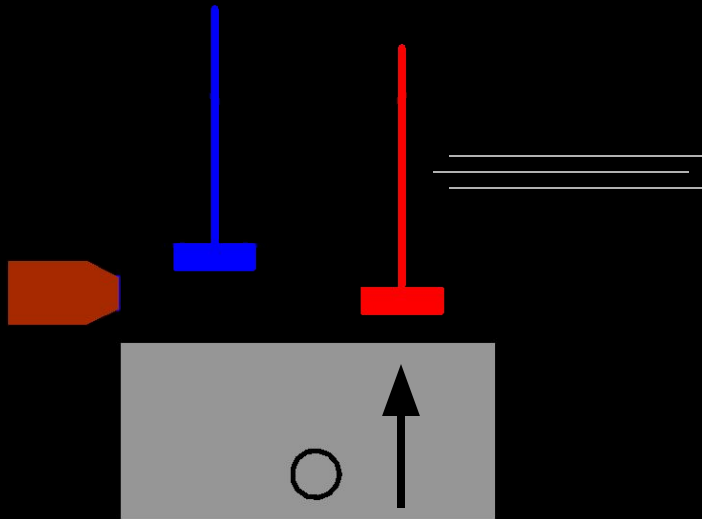

- Exhaust Stroke
 - Piston moves from BDC to TDC.
 - Exhaust valve is open.
 - Burnt air-fuel mixture is scavenged from combustion chamber.

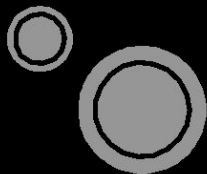

4-Stroke Cycle C.I. Engine

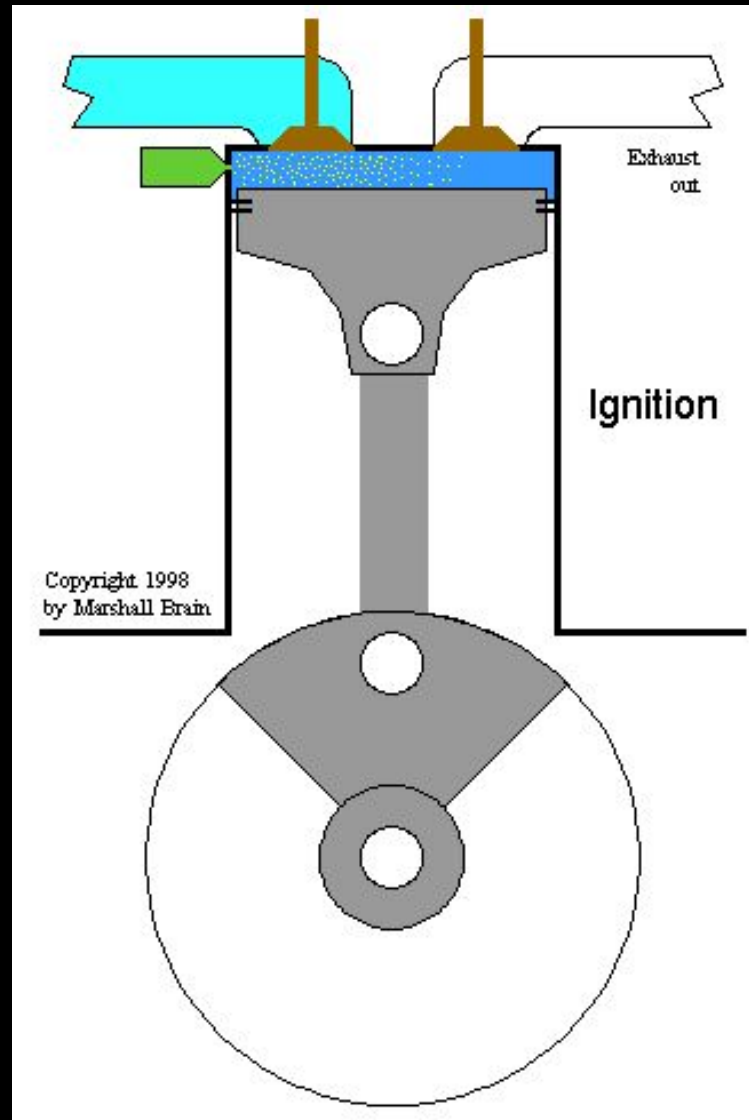

Comparison of 4-Stroke Cycle for C.I. And S.I. Engines

Stroke	C.I. (Diesel)	S.I. (Gasoline)
Intake	Air only	Air-fuel mix
Compression	C.R. \geq 14:1 Temp $>$ 729 °F	C.R. 6:1 – 12:1
Power	No difference	
Exhaust	No difference	

Two-Stroke Cycle Engines

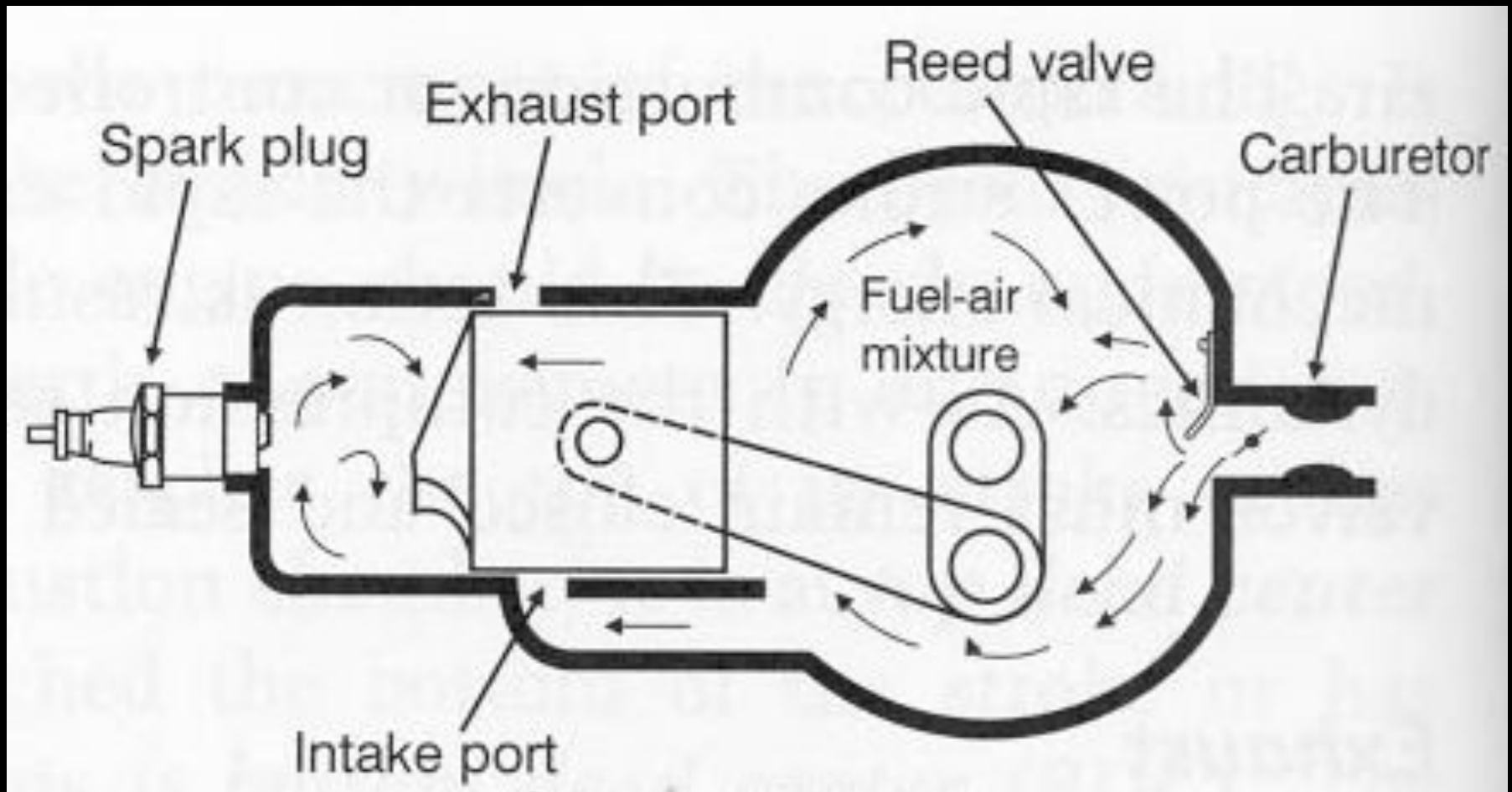

Two-Stroke Cycle Engine Operation

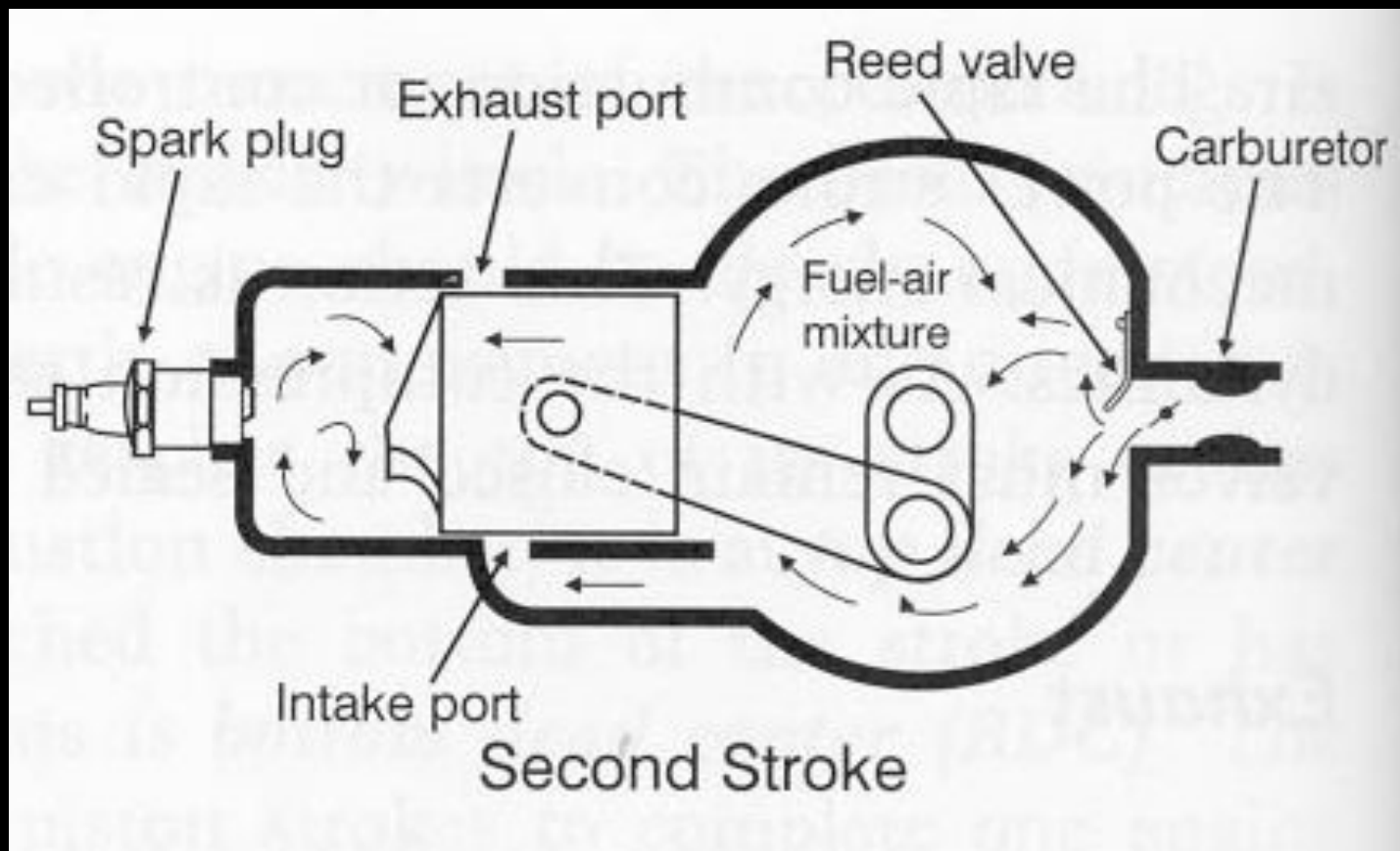

Comparison of Two-Stroke vs. Four-Stroke Cycle Engines

Two-Stroke Cycle Engines	Four-Stroke Cycle Engines
<ul style="list-style-type: none">Lighter weightOperates in many positionsHigher power to weight ratioEngine oil usually mixed with fuelLouder operationHigher engine speedsMore vibrationRough idling operation	<ul style="list-style-type: none">Heavier weightOperates in limited positionsLower power to weight ratioEngine oil in a reservoirQuieter operationSlower engine speedsSmoother operationSmoother Idling operation