

Параллелепипед. Призма. Пирамида.

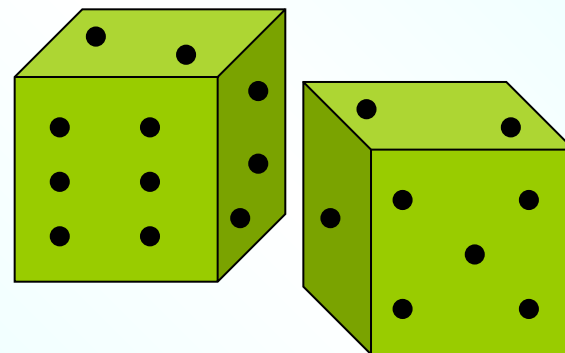
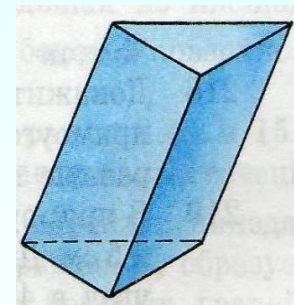
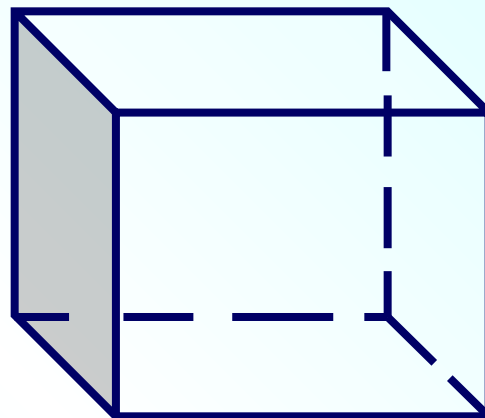
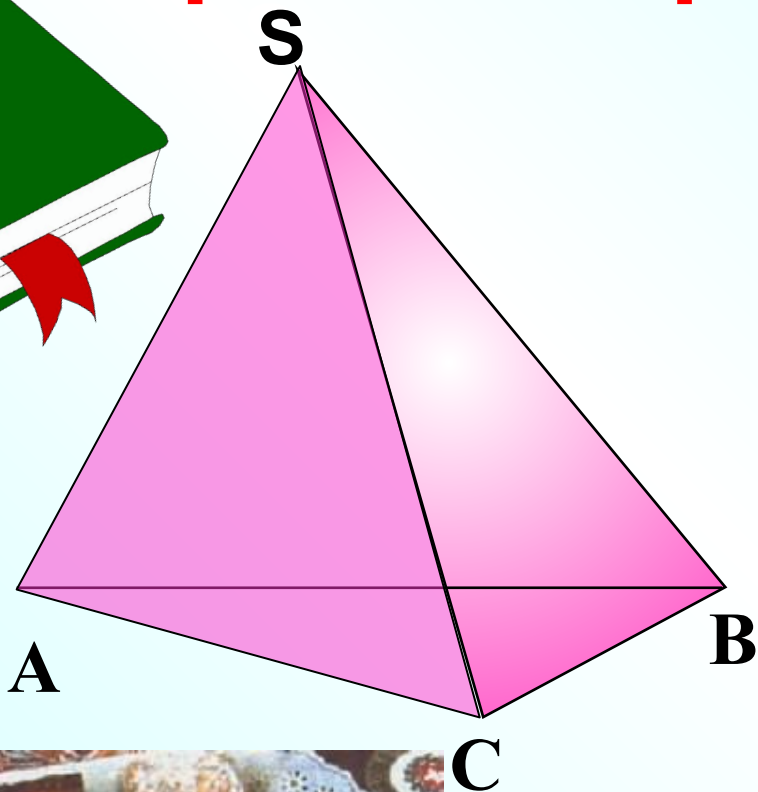
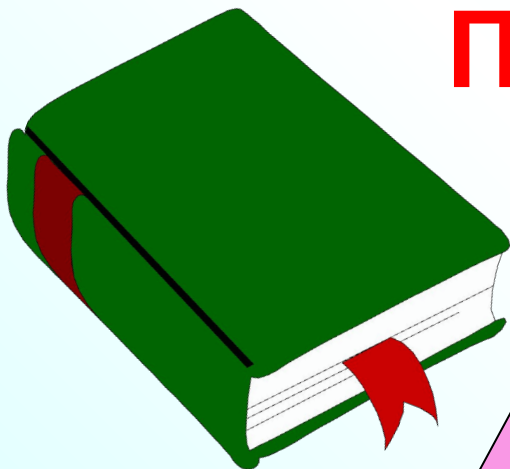
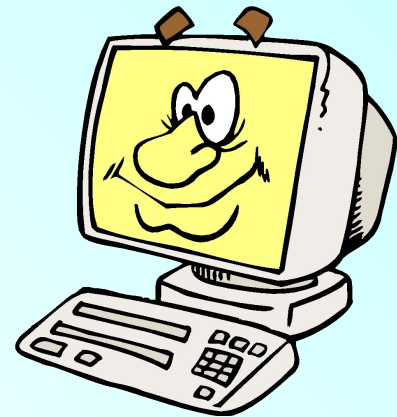

Мақсаты:

- Тікбұрышты параллелепипед туралы білімдерін жүйелей түсіндіру; тік параллелепипед, тік призма, пирамида ұғымдарымен және олармен байланысты биіктік, жағы, төбесі, табаны ұғымдарымен таныстыру; тік параллелепипедті, тік призманы, пирамиданы бейнелеп үйрету.
- Оқушылардың конструктивті ойлауын дамыту.
- Оқушыларды ізденімпаздыққа, жауапкершілікке, ұйымшылдыққа, іскерлікке тәрбиелеу.

Тікбұрышты параллелепипед

Тіктөртбұрыштармен шектелген
кеңістіктік денені **тікбұрышты
параллелепипед** деп атаймыз.



Төбелер-8

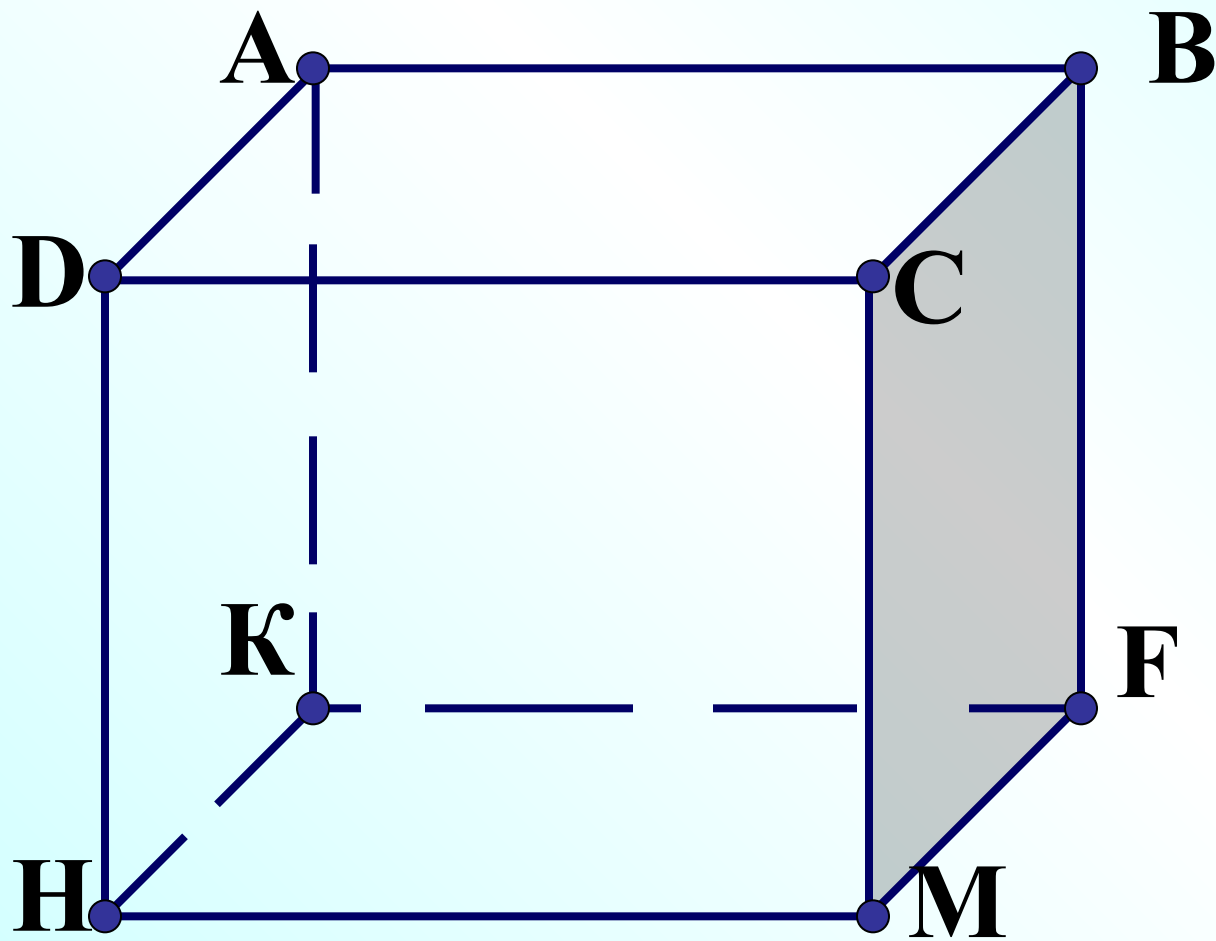

12 қыры

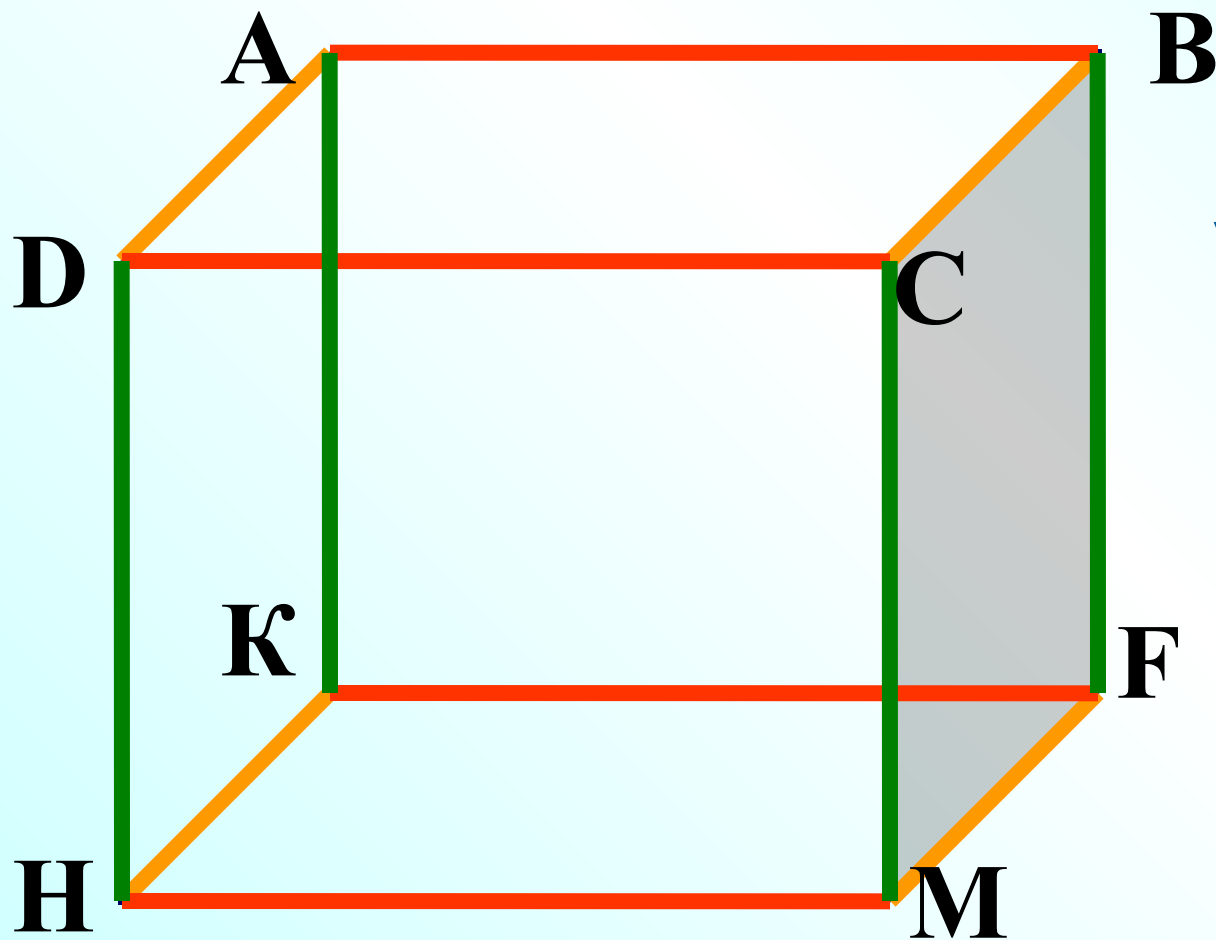

ұзындығы

ені

биіктік

6 жағы

Тіктөртбұрыштар

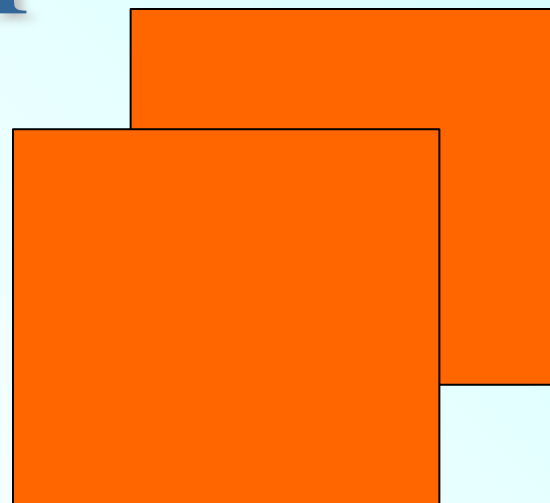
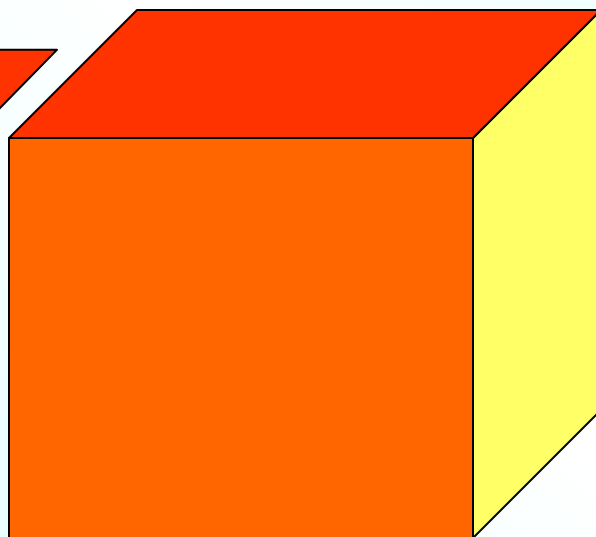

Қарама қарсы
жақтары тең !

Төбелері - нүктелері

Жақтар – тіктөрбұрыштар

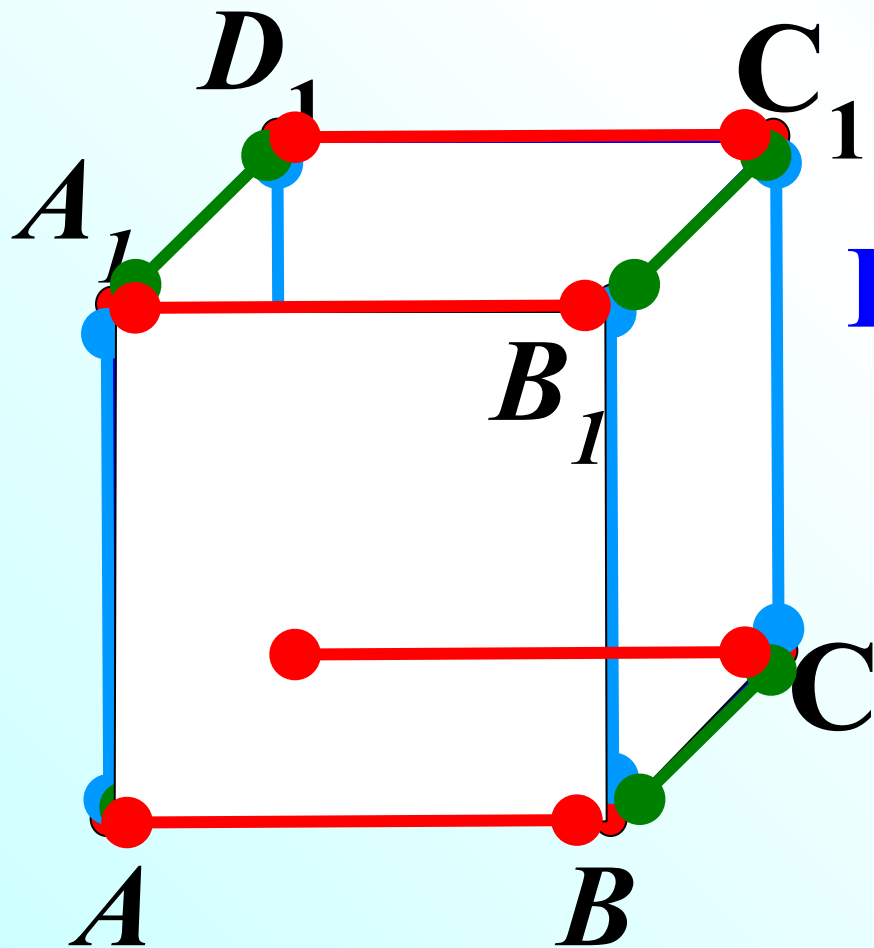

Қабырға - кесінді

$V=abc$ Тіктөртбұрышты параллелепипедтің көлемі

$S=2ab+2ac+2bc$ Бетінің ауданы

$S=2(a+b+c)$ Қабырғаның ұзындығы

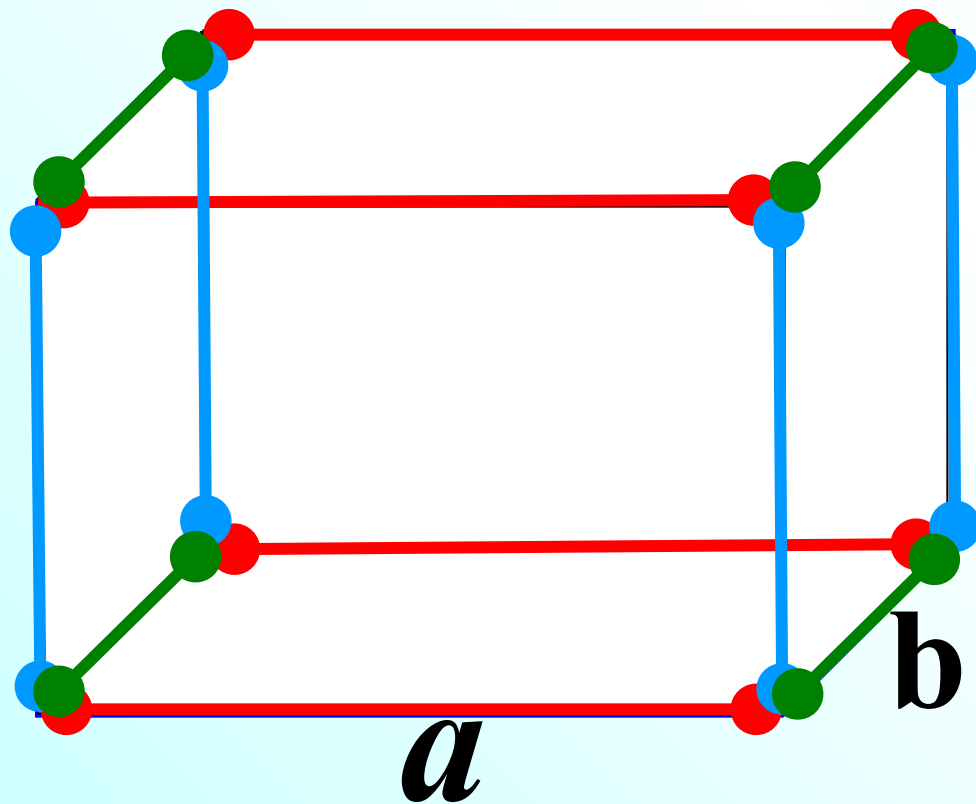

$$L=4a+4b+4c$$

$$cL=4(a+b+c)$$

$$V=a^3$$

Кубтің көлемі

$$S=6a^2$$

Куб бетінің ауданы

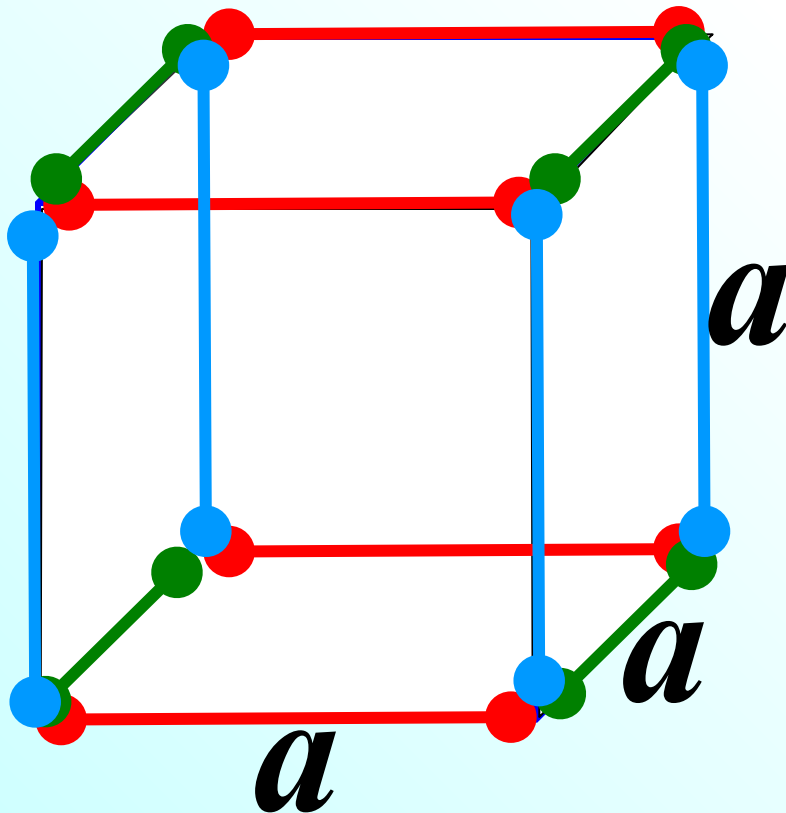

$$L=12a$$

Куб
қабырғаларының
ұзындығы

Қандай заттар
тік төртбұрышты
параллелепипедтің формасы
түрінде
болып табылады?

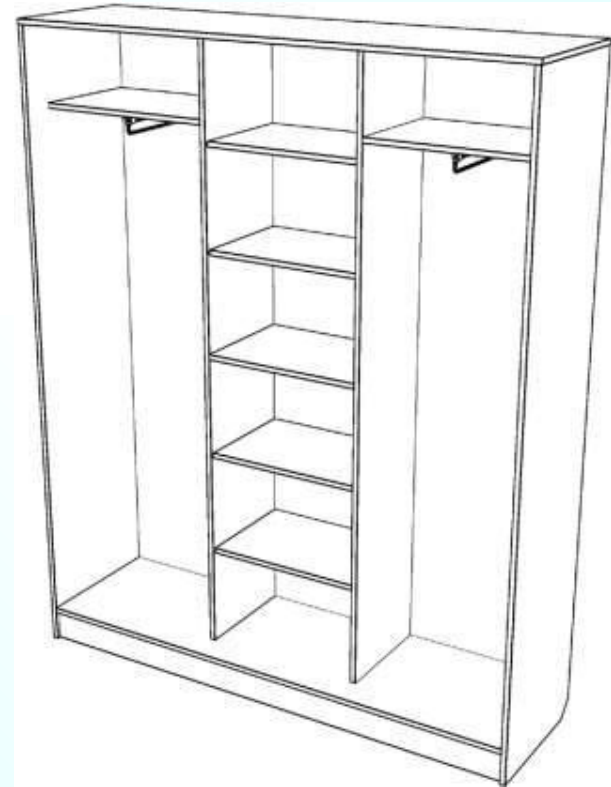
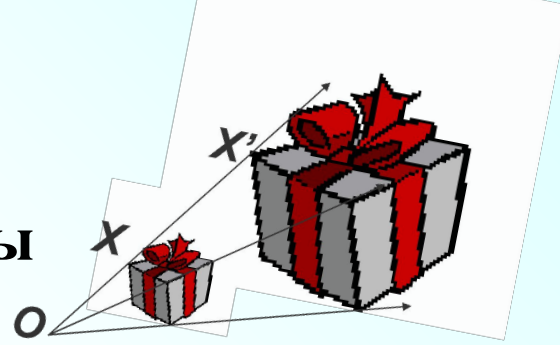

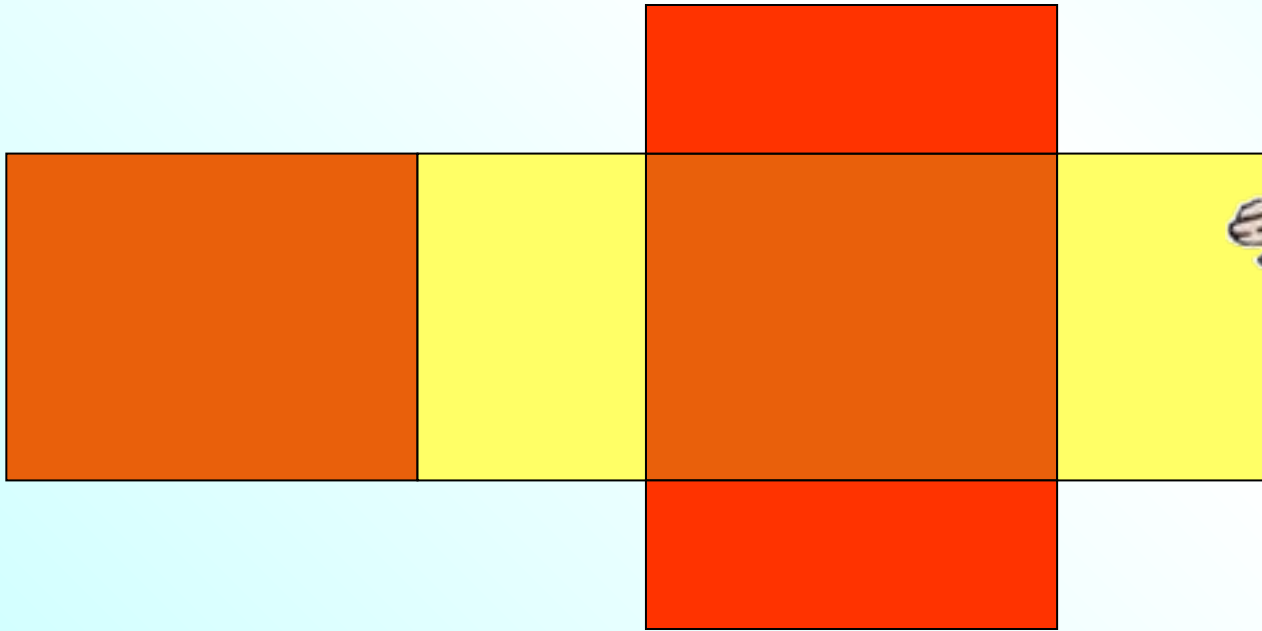
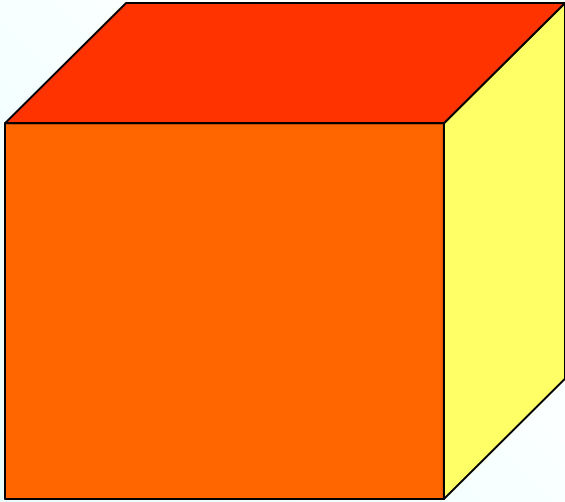

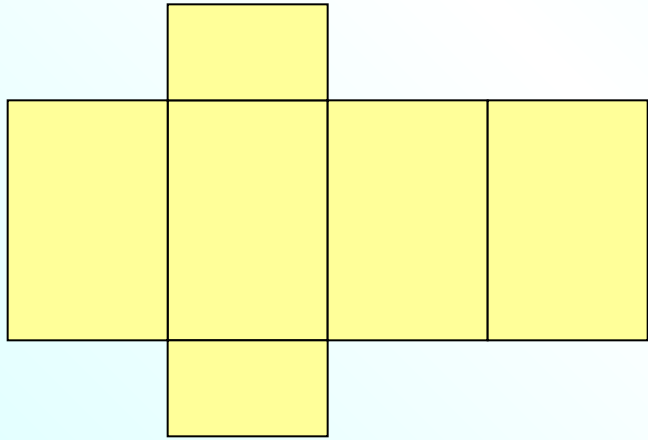

1

4

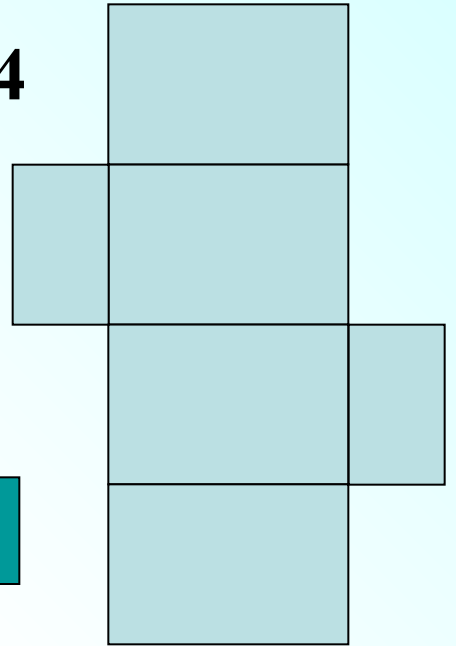

3

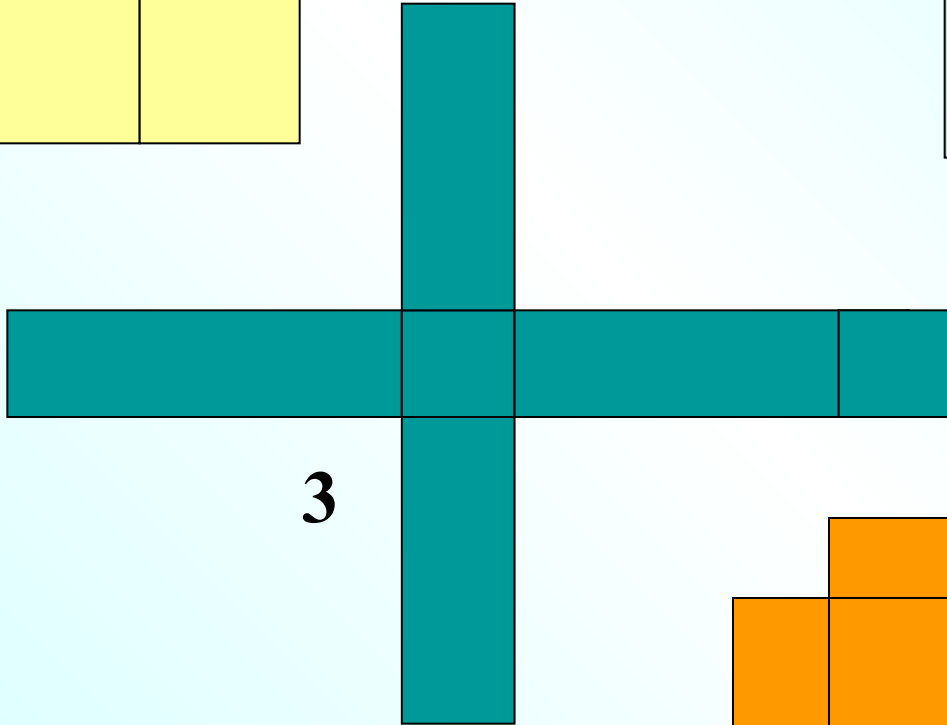

2

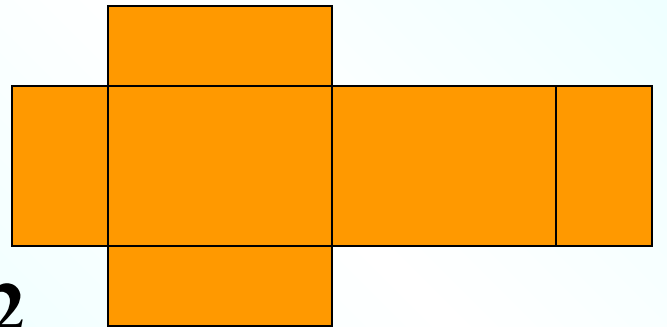

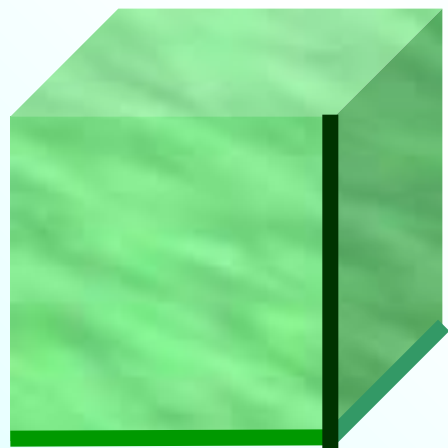

**Куб-тікбұрышты
параллелепипед,
барлық
өлшемдері тең**

*Қандай геометриялық
фигуралар кубтың
жақтары болып
табылады?*



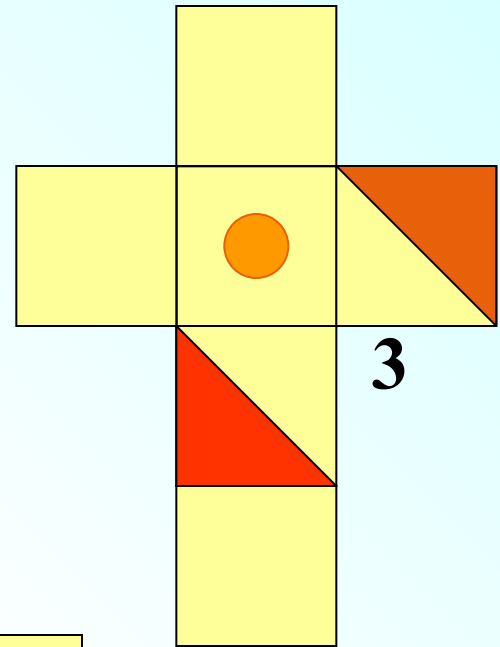
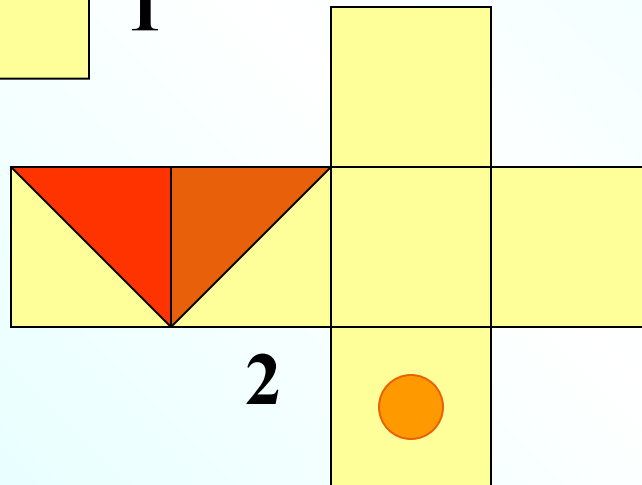
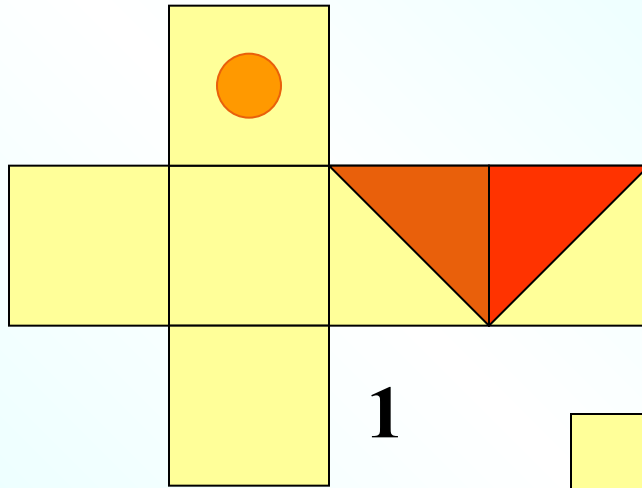
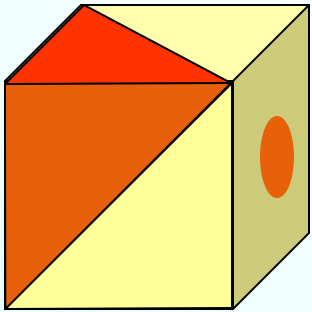

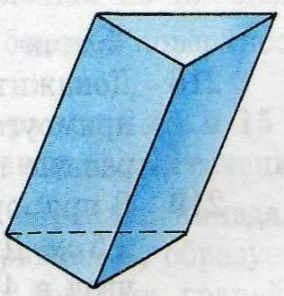

Призма

Табандары параллель жазықтықтарда жататын тең көпбұрыштардан тұратын, бүйір қырлары табандарына перпендикуляр болатын кеңістіктік денелерді **призмалар** деп аталады.

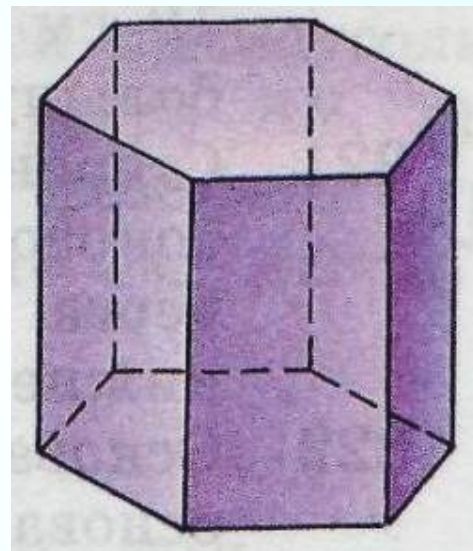
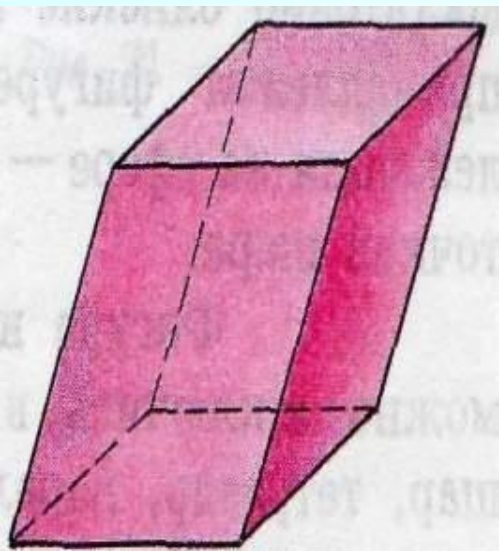

Призманың анықтамасы:

$A_1A_2\dots A_nB_1B_2B_n$ – *призма*

Көпбұрыштар $A_1A_2\dots A_n$ и $B_1B_2\dots B_n$ – *призманың табаңдары*

Параллелограммдары $A_1A_2B_2B_1, A_1A_2B_2B_1, \dots$
 $A_nA_1B_1B_n$ – *бүйір жақтары*

Отрезки $A_1B_1, A_2B_2\dots A_nB_n$ – *призманың бүйір қабырғалары*

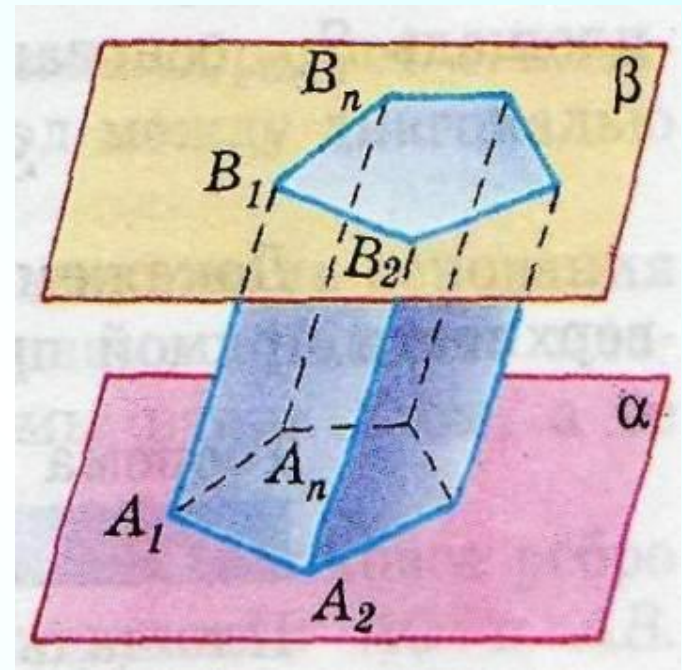

Призмалардың түрлері

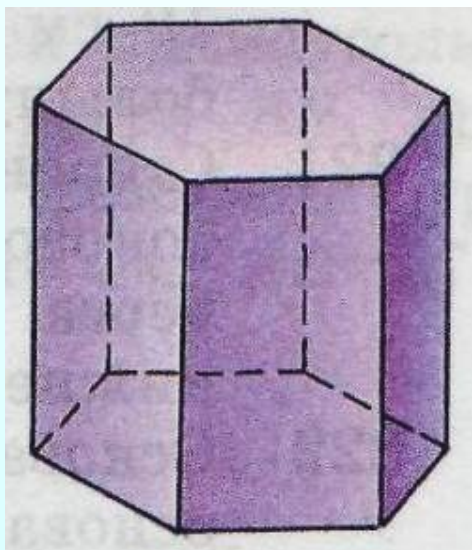

Алтыбұрышты
призма

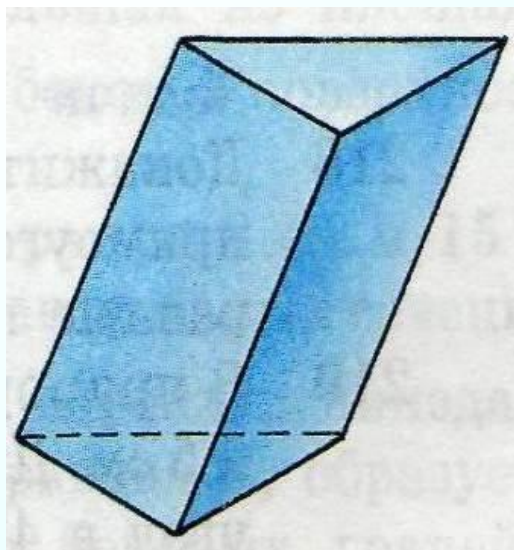

Үшбұрышты
призма

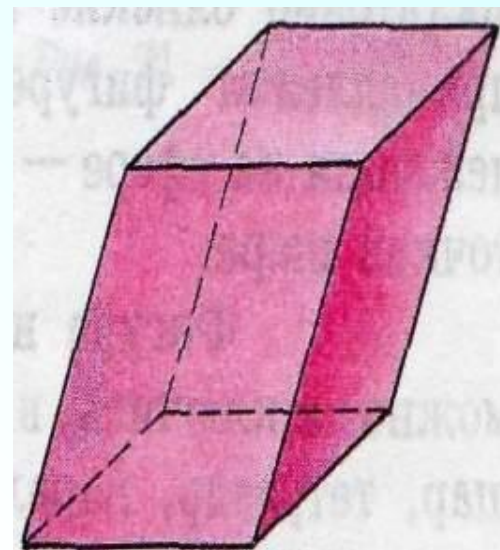

Төртбұрышты
призма

Призманың толық бетінің ауданы

$$S_{\text{толық}} = S_{\text{бүйір}} + 2S_{\text{табан}}$$

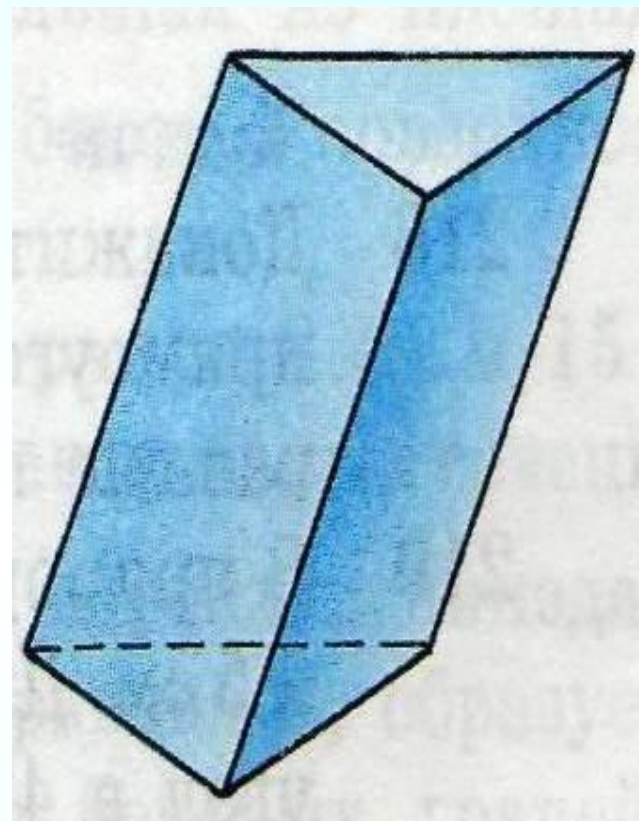



Пирамида

РН - пирамиданың
биіктігі

Төбесі

P

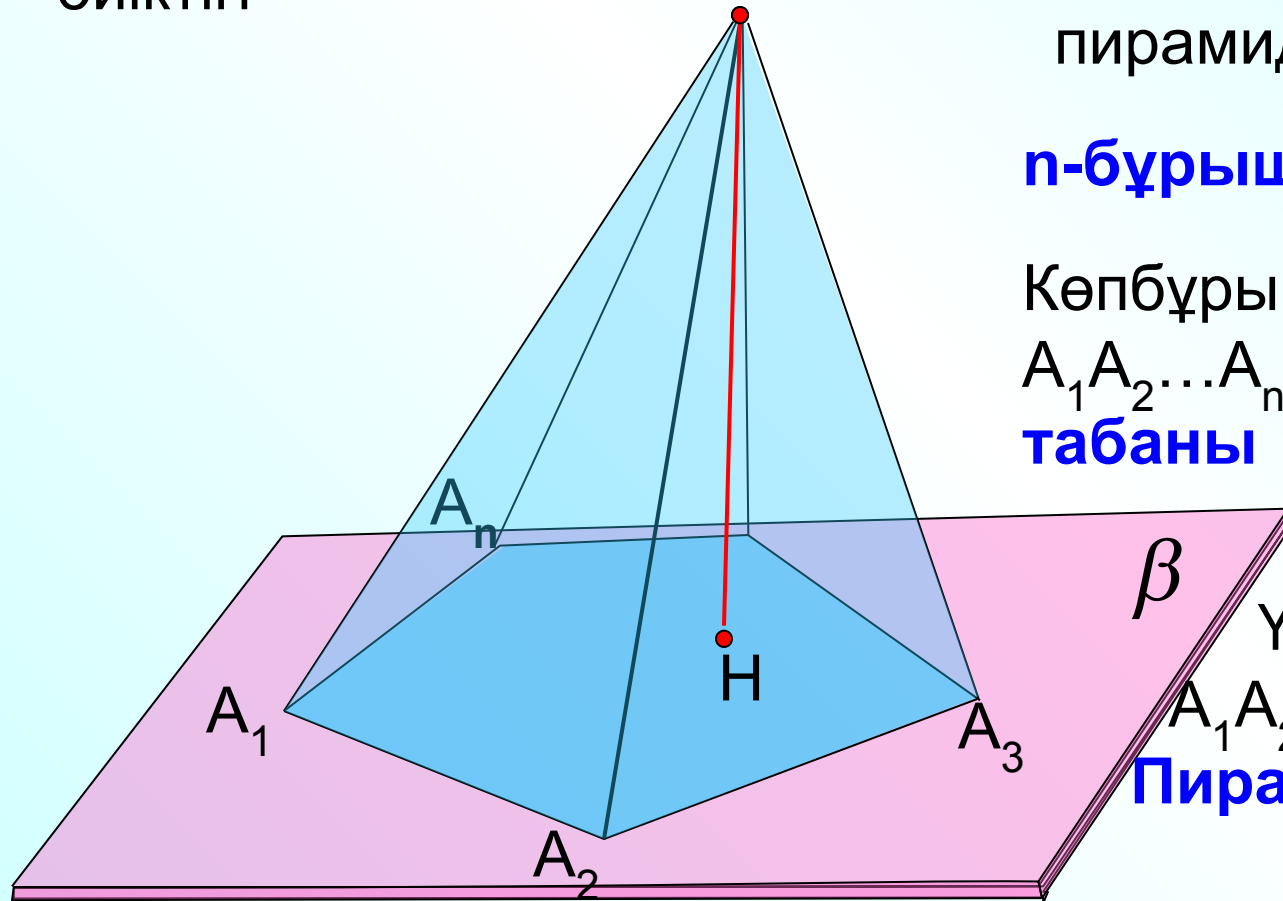

Көпбұрыш, n-бұрыштардан
 $A_1A_2 \dots A_n$
n үшбұрыштардан,
құрылған
пирамида деп аталады.

n-бұрышты пирамида.

Көпбұрыш

$A_1A_2 \dots A_n$ – пирамиданың
табаны

Үшбұрыштар

A_1A_2P , A_2A_3P т. с. с.

**Пирамиданың бүйір
жақтары**

Кесінділер A_1P , A_2P , A_3P
т. с. с

Бүйір қабырғалары

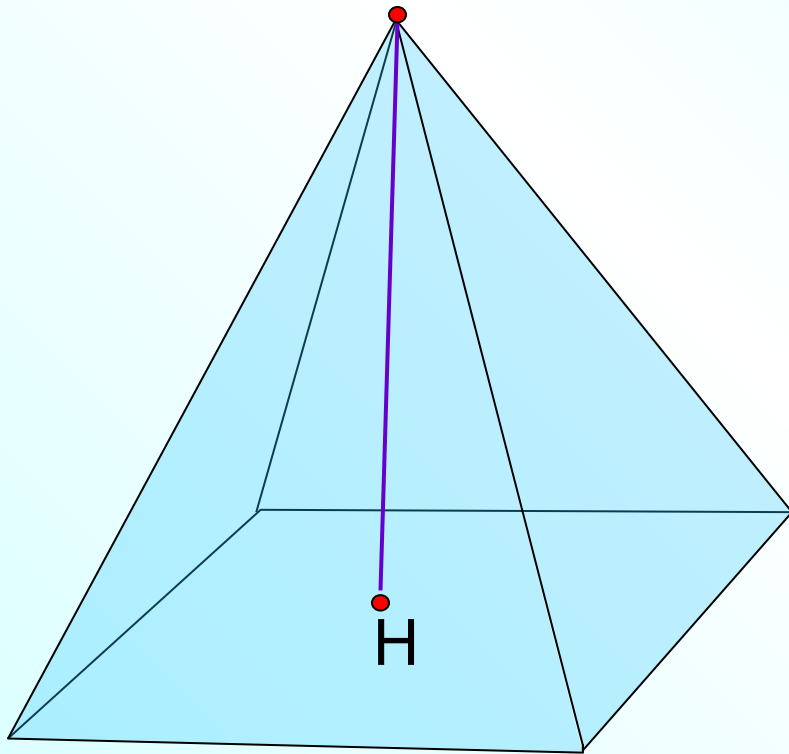

Төртбұрышты
пирамида

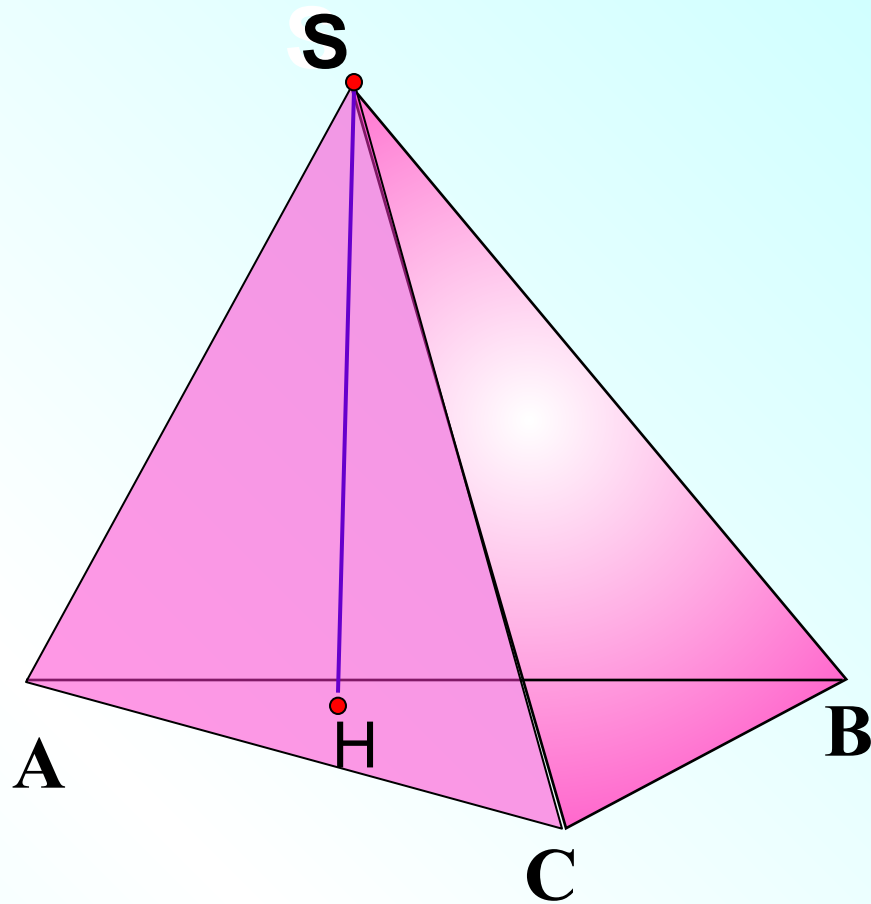

Үшбұрышты пирамида – бұл
тетраэдр

Бесбұрышты
пирамида

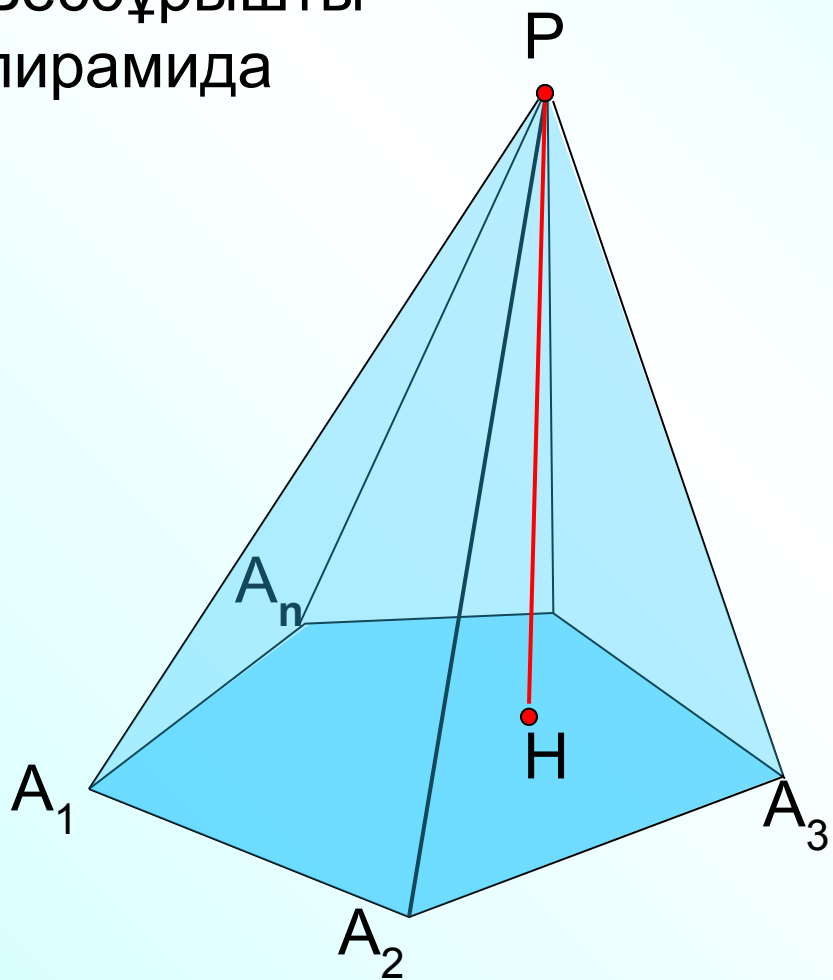

Алтыбұрышты
пирамида

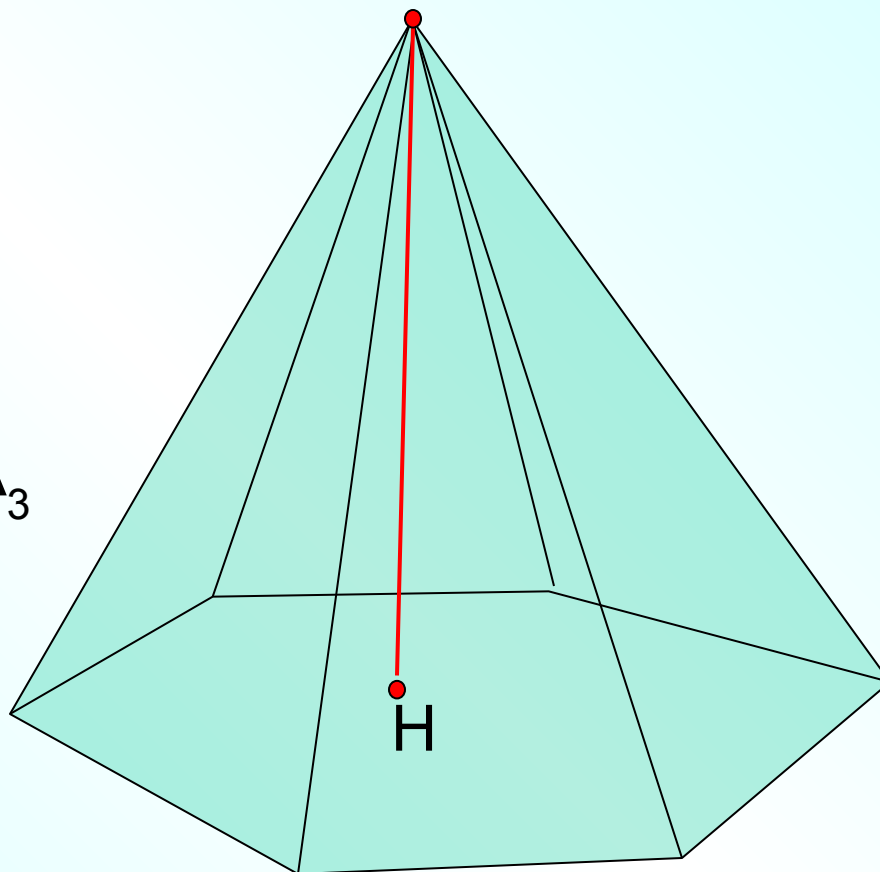

Параллелепипедті 1 см қабырғасымен бірдей кубиктерден қосты.

Ол үшін неше кубик қажет болды?

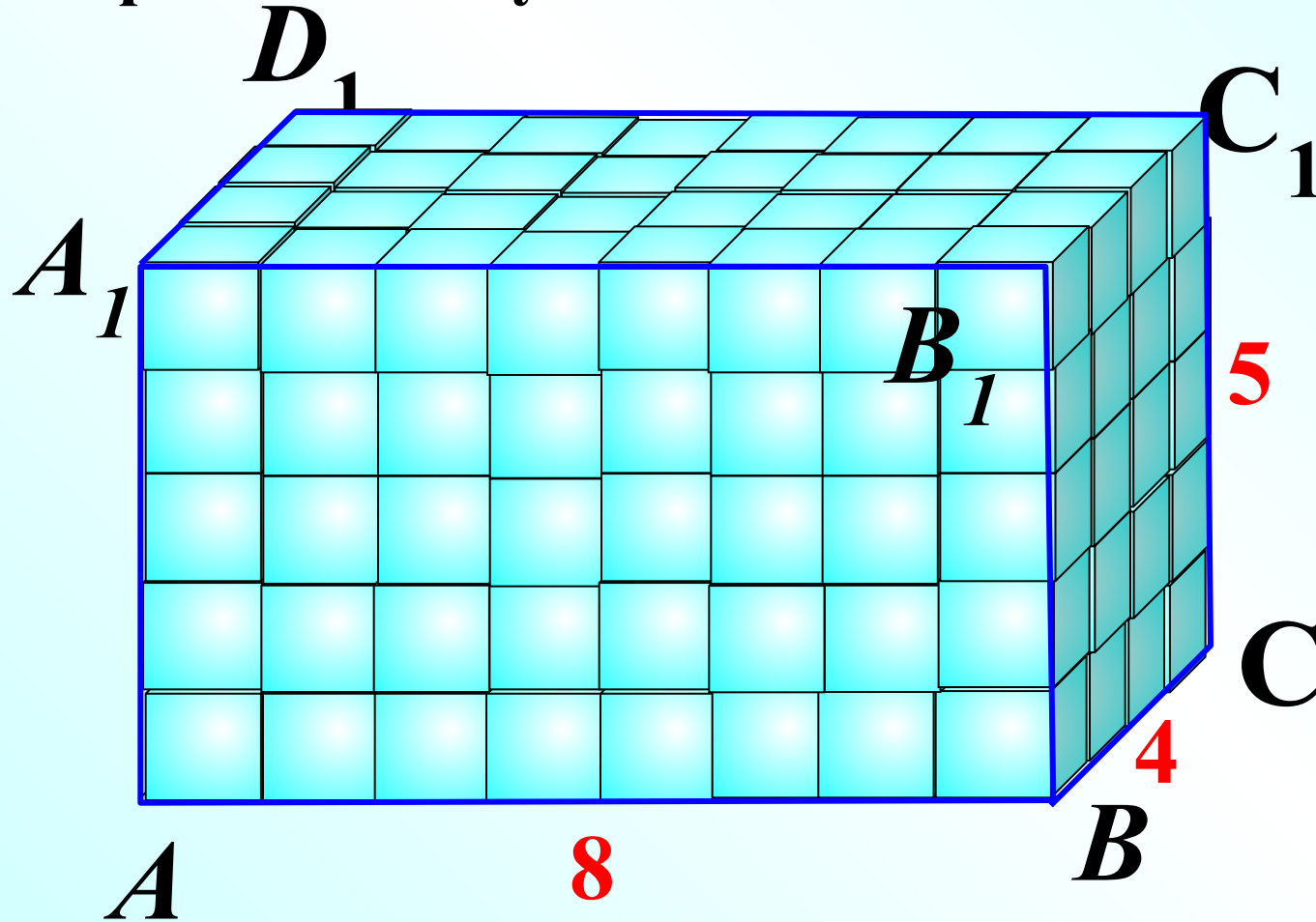

$$V=8*4*5=160(\text{cm}^3)$$

Осы фигуралардың көлемдерін табыңыз

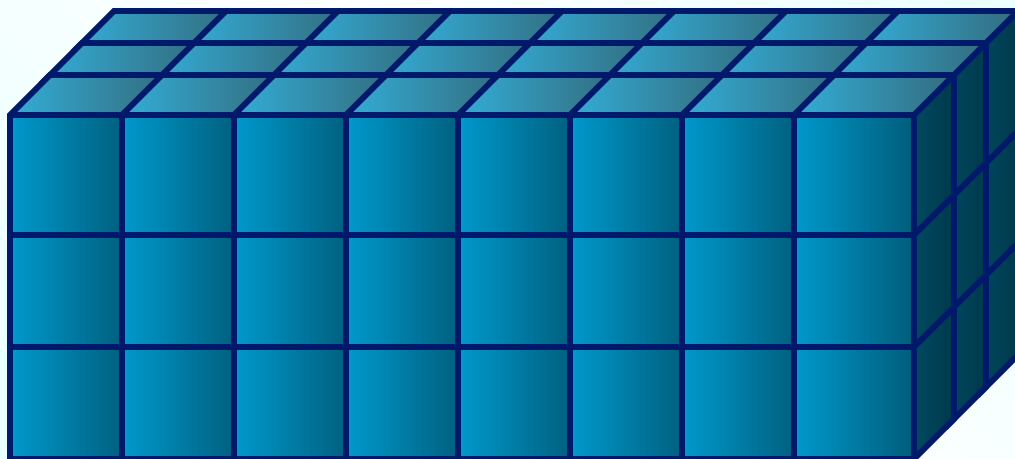
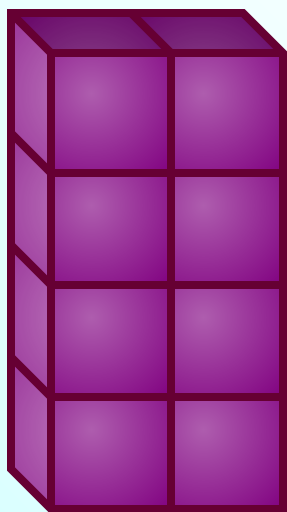
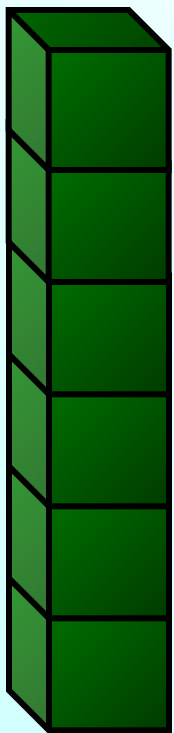
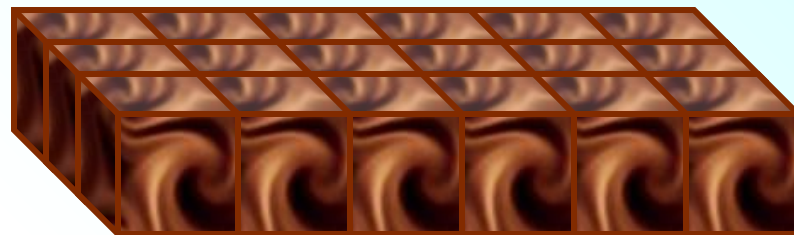
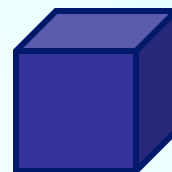
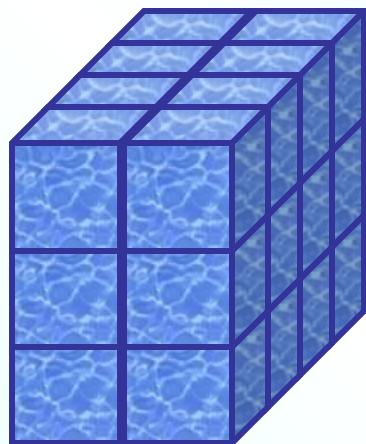
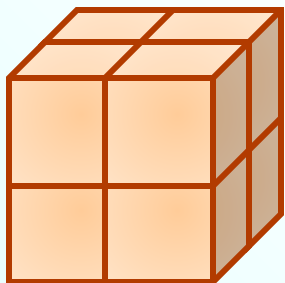

Тексеру:

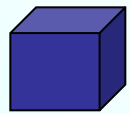

1) $V=1$

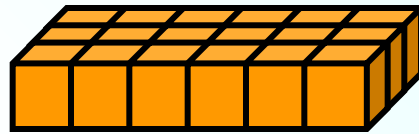

4) $V=18$

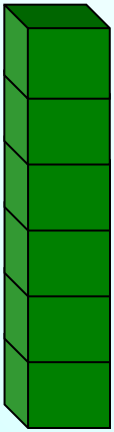

2) $V=6$

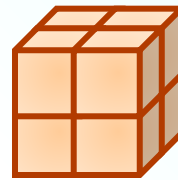

5) $V=8$

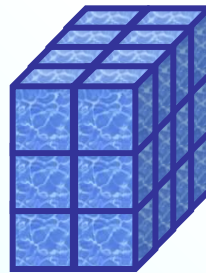

6) $V=24$

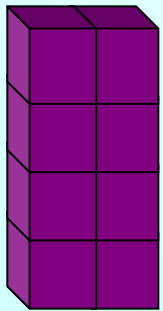

3) $V=8$

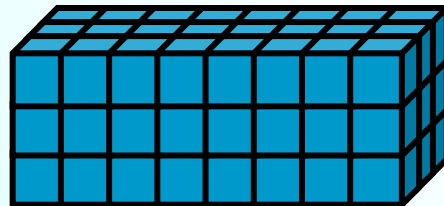

7) $V=72$

а) Қандай аквариумдардың дайындалуына көп шыны қажет болды?

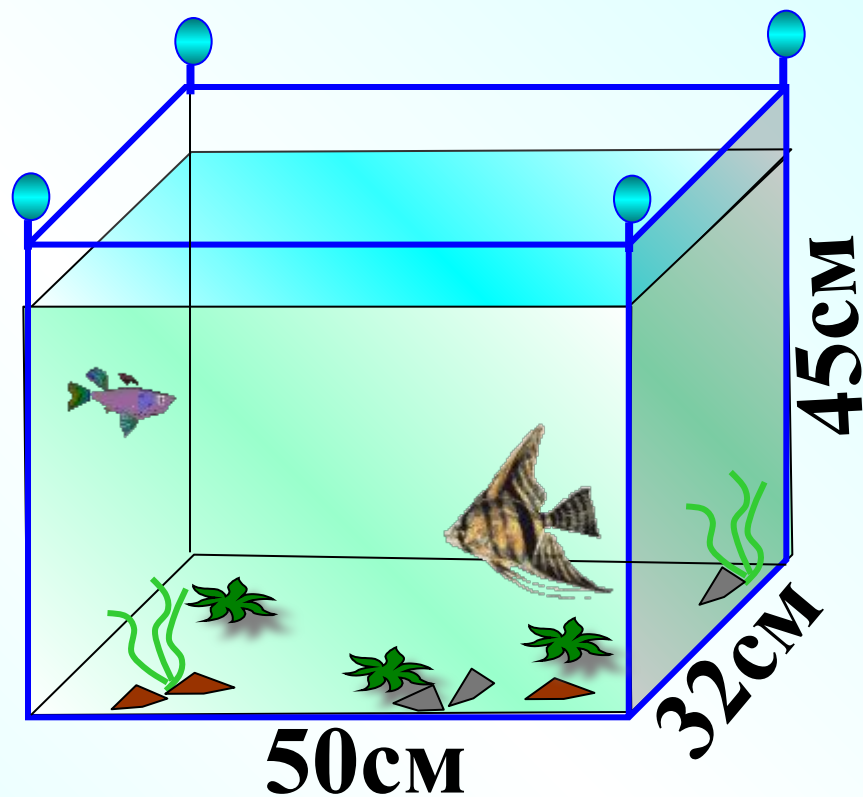
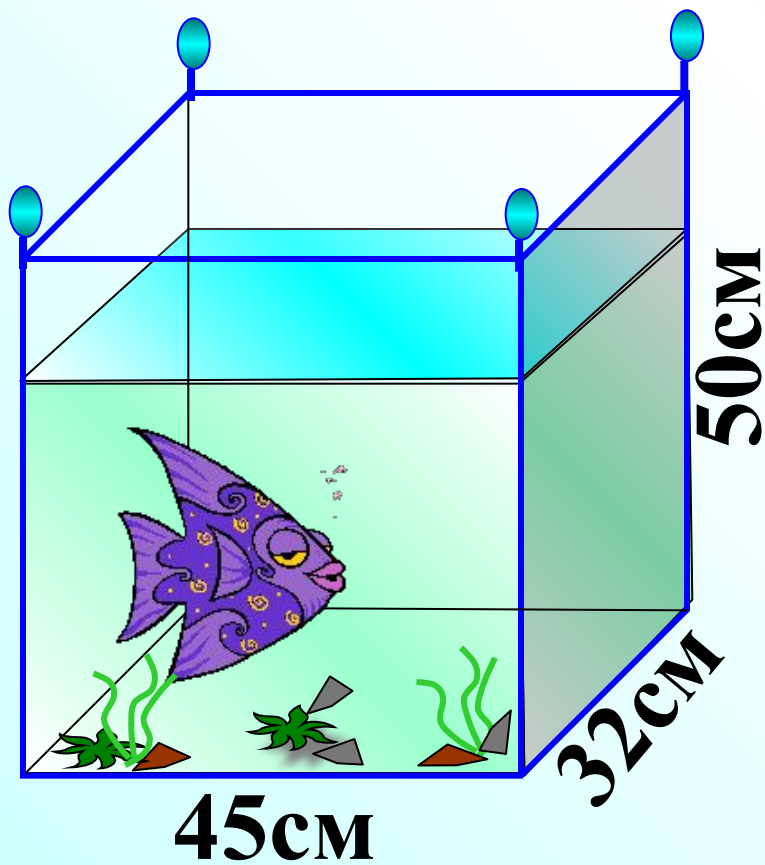

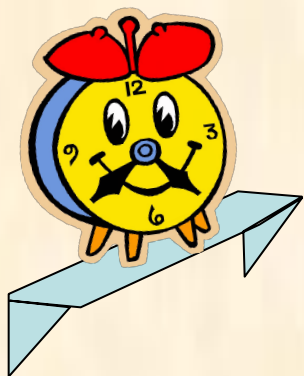

4,8м

10,25м

7,5м

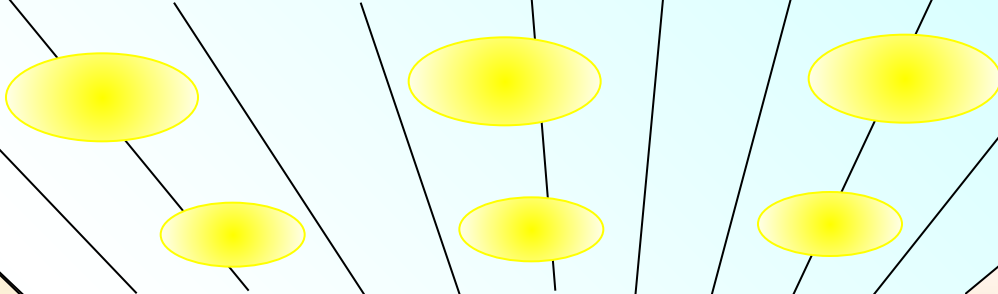
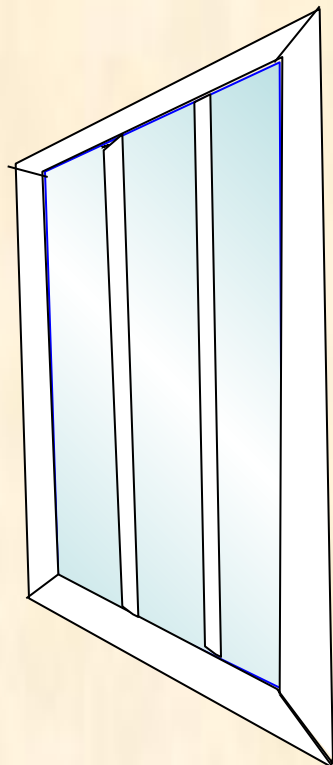

Дененің көлемін анықтаңыз, егер

$$AA_1=AB=AF=20\text{см},$$

$$BC=12\text{ см}, \quad CD=8\text{см}.$$

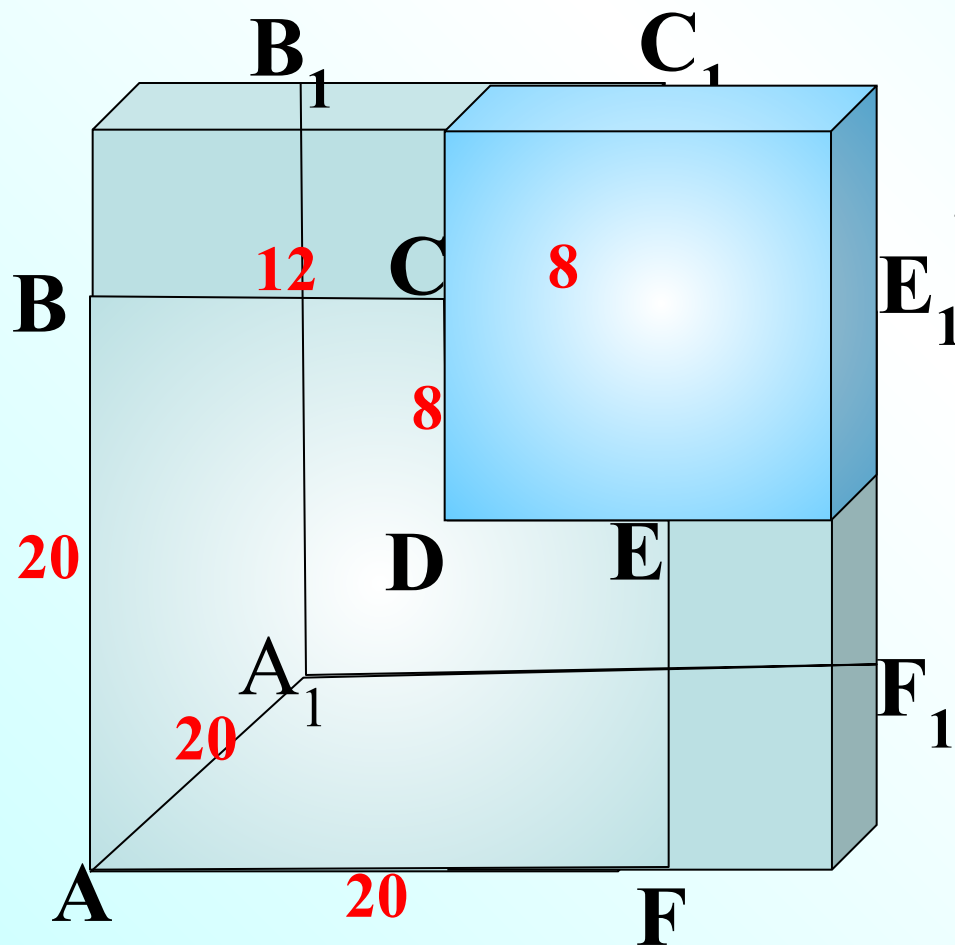

$$1) 20^3=8000(\text{см}^3) \quad V_1$$

$$2) 8*8*20=1280(\text{см}^3) \quad V_2$$

$$3) 8000 - 1280 = 6720(\text{см}^3) \quad V_T$$

Жауабы:

Дененің көлемі
 $6720(\text{см}^3)$

Фигураның көлемін анықтау үшін формуланы құрастырыңыз.

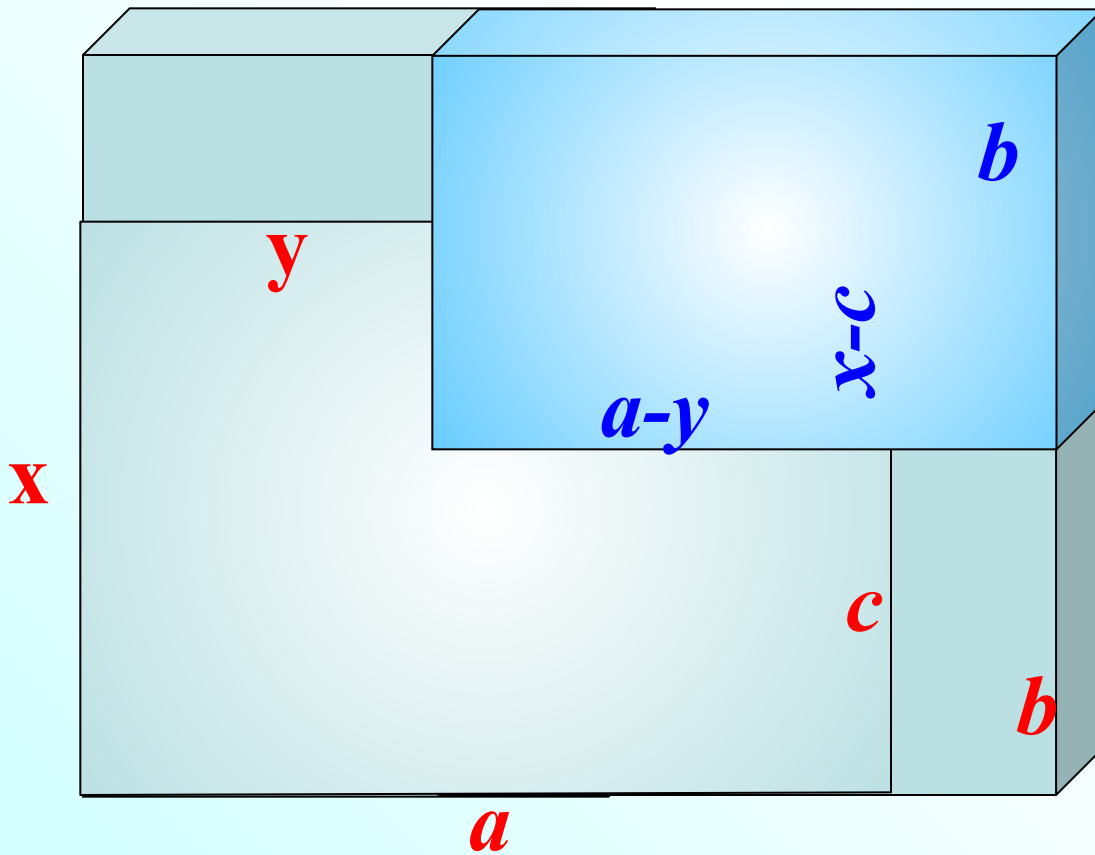

1) abx V_1

2) $(a-y)(x-c)b$ V_2

3) $abc - (a-y)(x-c)b$ V_ϕ

Фигураның көлемін есептеу үшін формуласын құрастырыңыз.

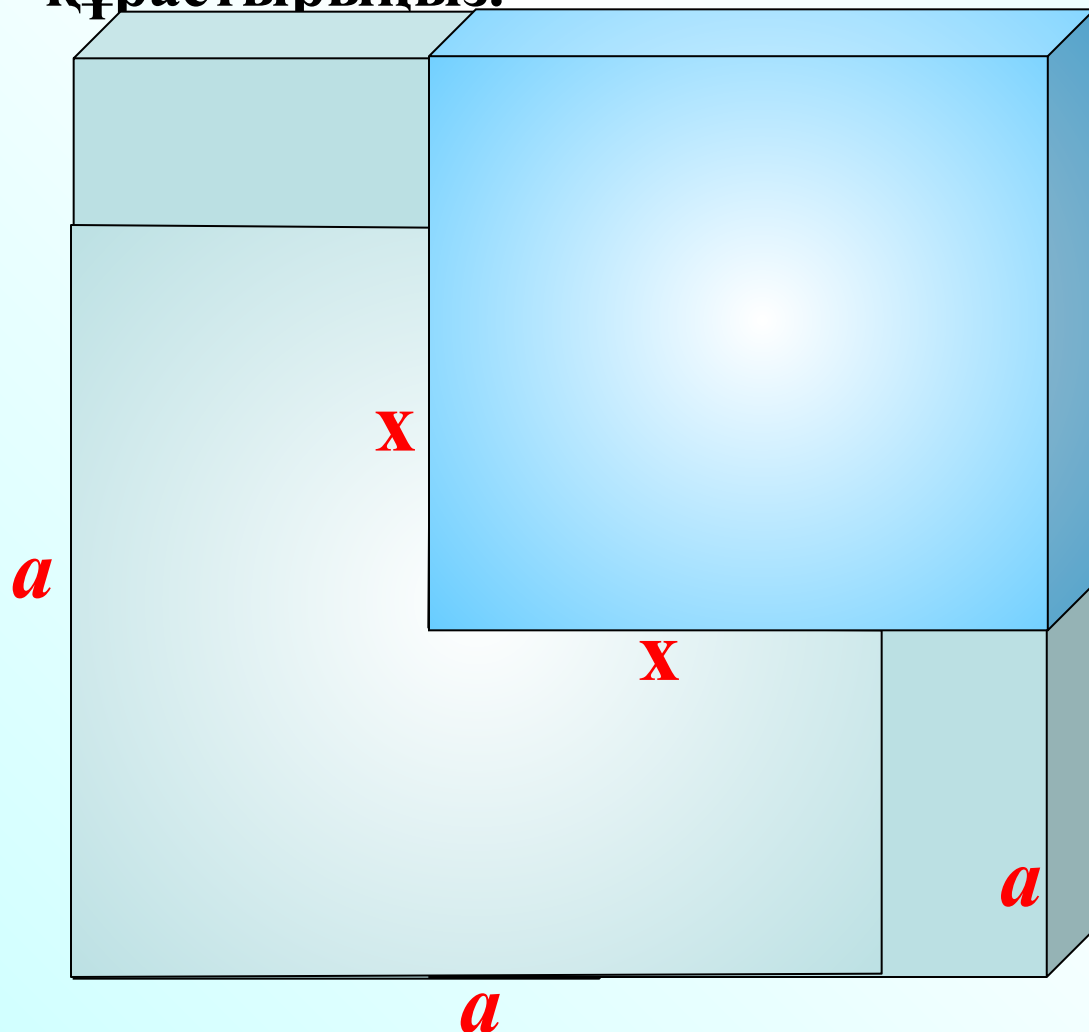

1) a^3 V_1

2) $axx=ax^2$ V_2

3) $a^3 - ax^2$ V_ϕ

Фигураның көлемін есептеу үшін формуласын
құрастырыңыз.

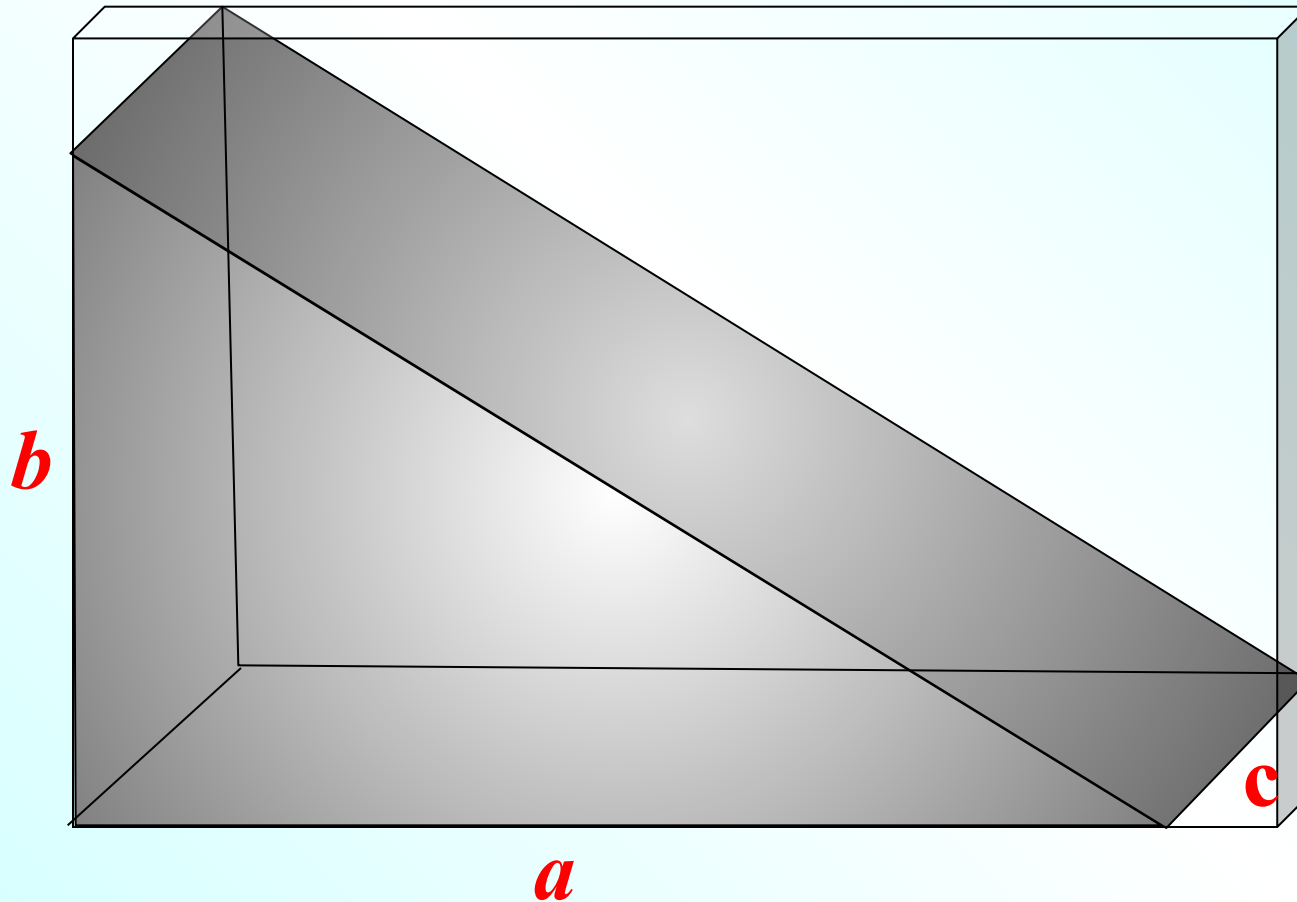

Үй жұмысы

П 17. N274. Фигуралардың моделін жасап әкелу