

Lapbook Templates

For personal or commercial use

Fully
Editable
In
PowerPoint

Create your
OWN lapbooks!!

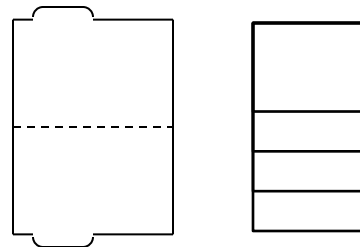
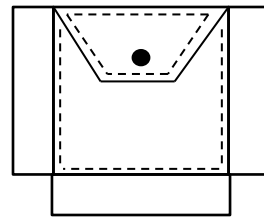
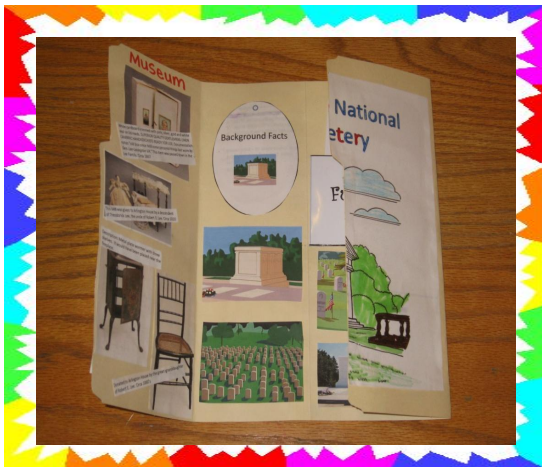

15 Lapbook Templates

Kathy Hutto

Create a lapbook with ease. Mix and Match
The templates you need to create your
Own custom lapbook in minutes!

This product is for personal and commercial
use. If you do use it, please just put a link
to my blog.

www.kathyhutto.wordpress.com

You can edit or change these in any way
to meet your lapbooking needs.

How to edit...

You will simply open this product up in Power Point.

To add text, click Insert, Text Box, and then click in the document where you want the text box to go.

Then, you can type any text you would like.

You can add images by clicking Insert, Picture – and then find where you have the picture saved.

You can add New Slides under the Home tab. This will allow you to move the templates around and create your own lapbook.

If you have any problems, please feel free to email me at khutto@dicomm.net.

15 Lapbook Templates

Diamond Fold

Blue Jean Pockets

Skinny Books

Simple Pockets

Match Books

Tall Match Books

Four Fold Booklet

Simple Four Fold Book

Conversation Bubbles

Swinging Ovals

Stackable Book

Wheel

Mini File Folders

Petals

Surf Board Book

Diamond fold -
Cut out as one piece. Fold on the dotted lines so
that the points touch.

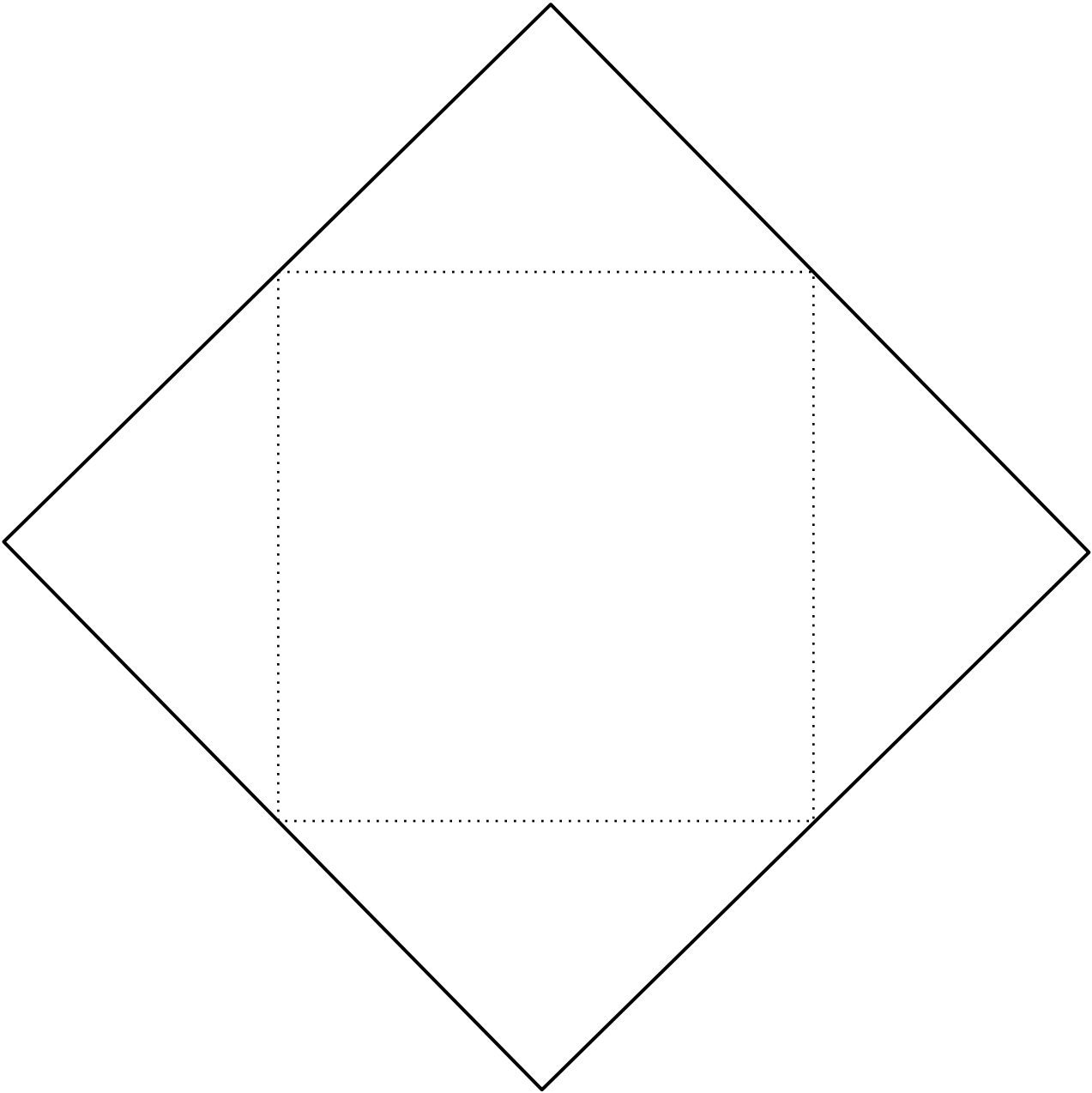

Blue Jean pocket -

Cut out as one piece. Fold side and bottom flaps under and glue these flaps to folder leaving the top open.

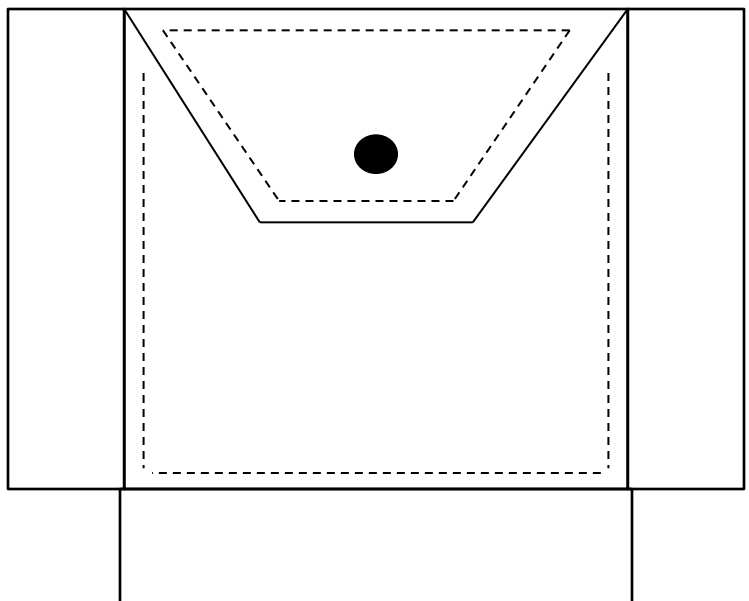
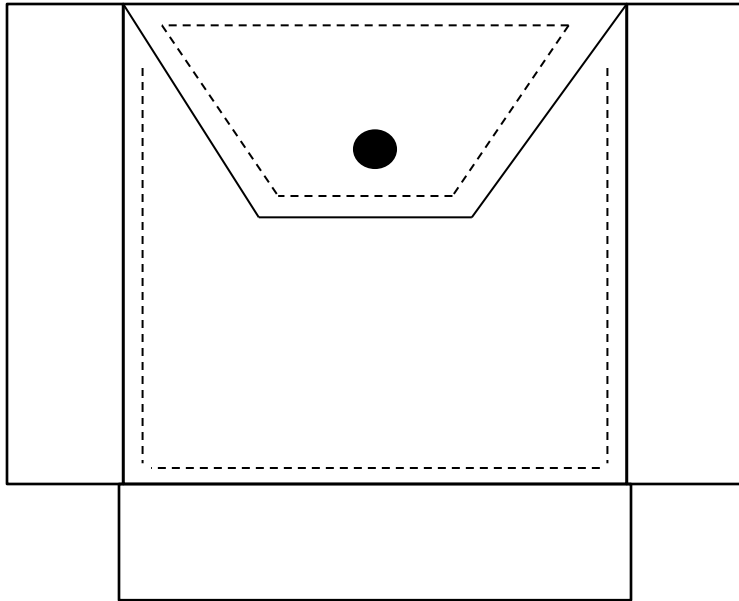

Skinny Book -
Cut out as one piece. Fold in the middle and glue the
back of the book to the folder.

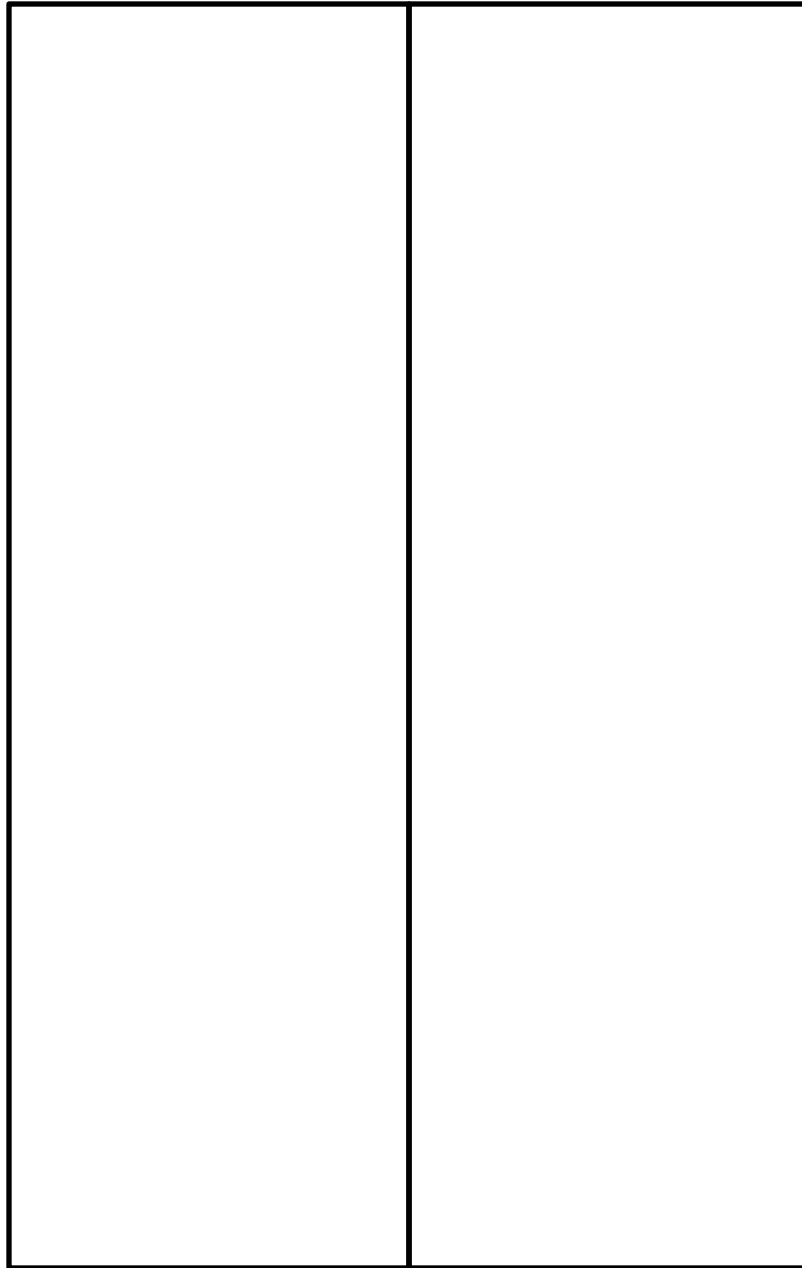

Title
here



Simple Pocket –
Cut as one piece. Fold the sides under and glue to
the folder.

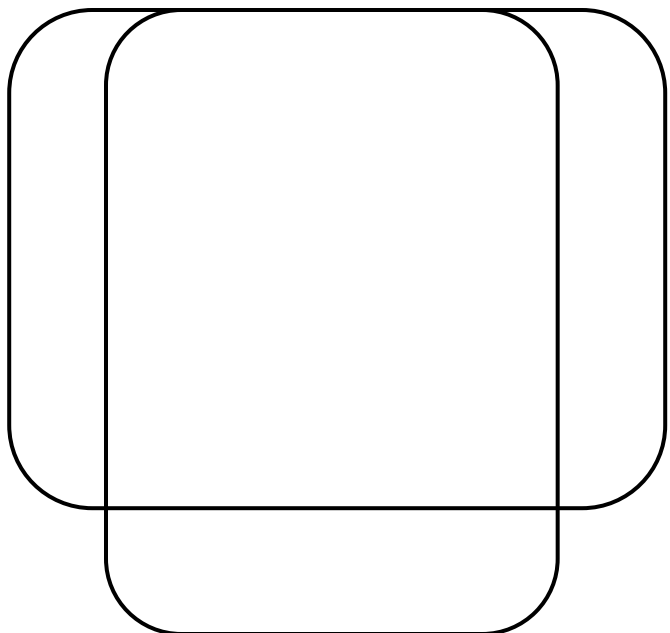
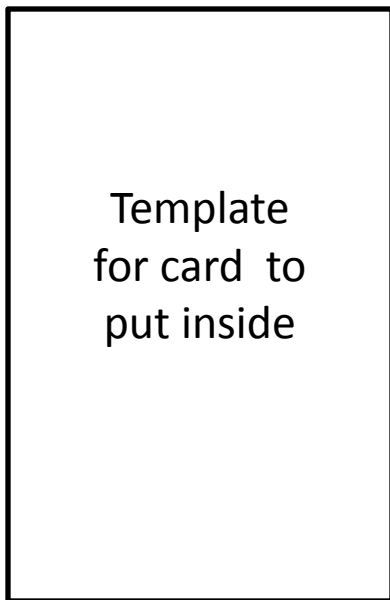
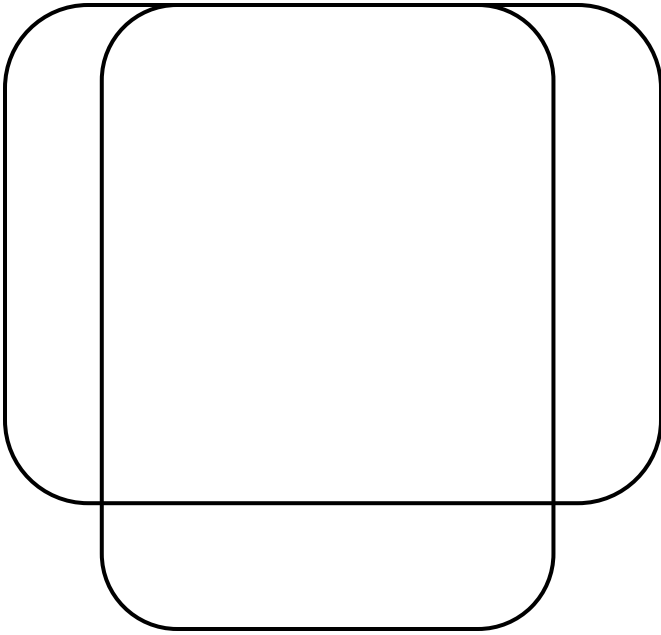

Matchbooks –

Cut as one piece. Fold on the dotted lines. Glue the back of the middle section to the folder.

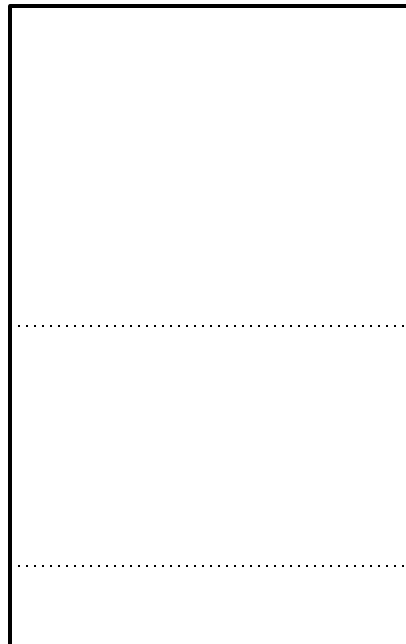
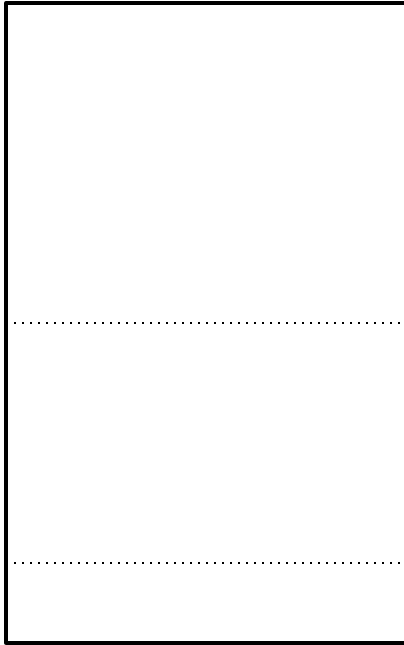

Tall Matchbooks –

Cut as one piece. Fold on the dotted lines. Glue the back of the middle section to the folder.



Four Fold Booklet –

Cut as one piece and then cut the four slits on the dotted lines. Fold down the middle. Glue the back to the folder. The four flaps should be in front.

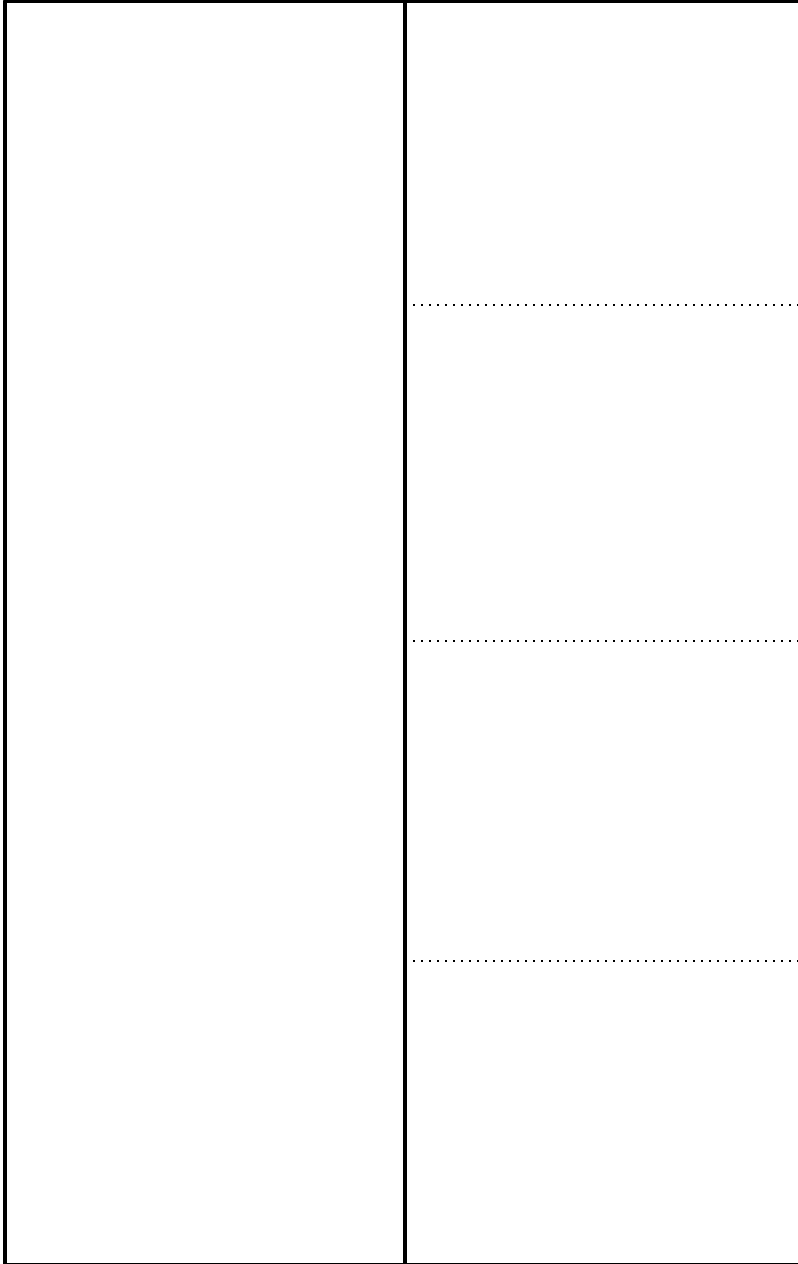

Simple 4 Fold Book –

You can cut all four pieces out and then staple the sides together or just fold this in half and half again.

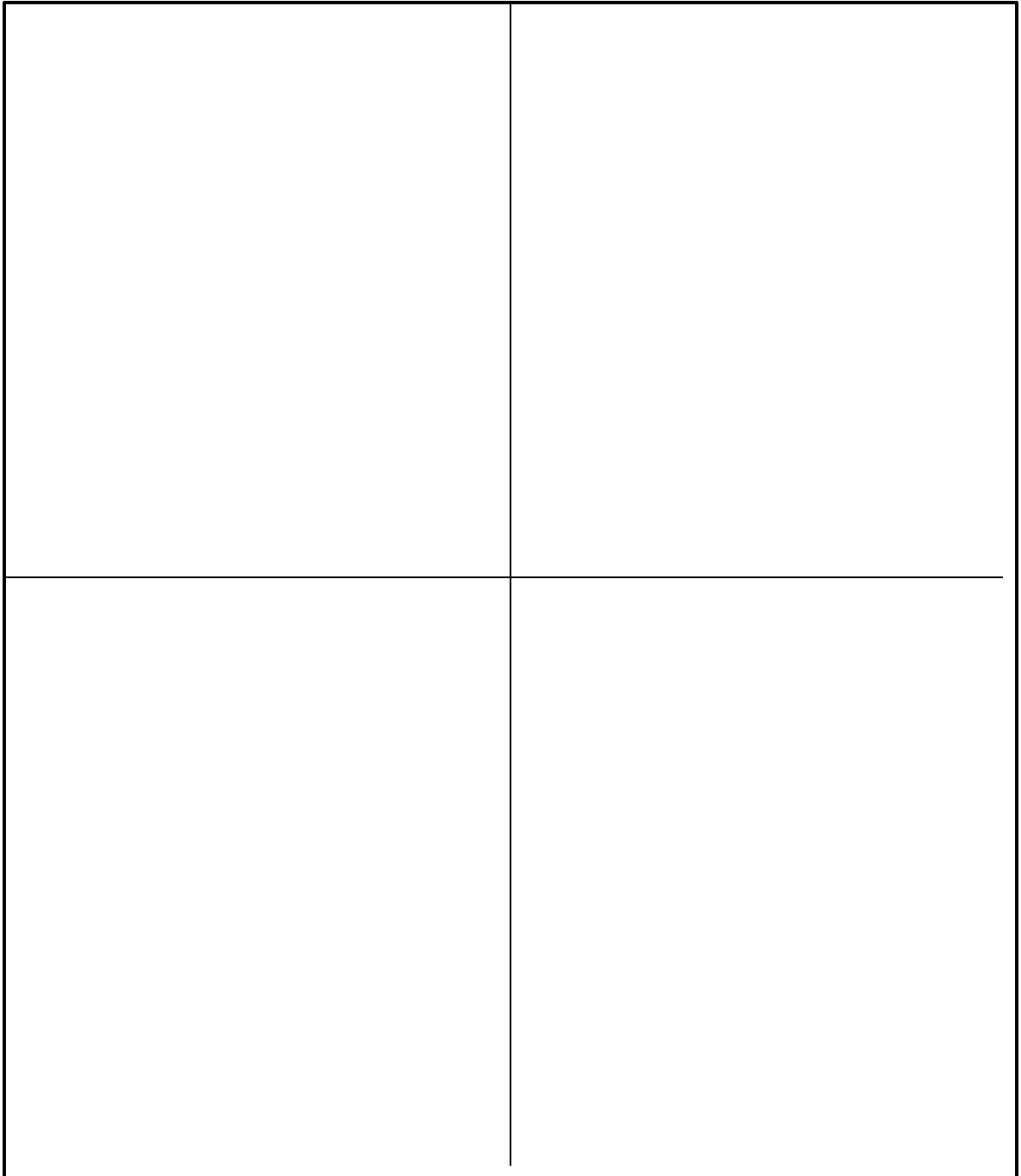

Conversation Bubbles –
Cut out in one piece and write your text.

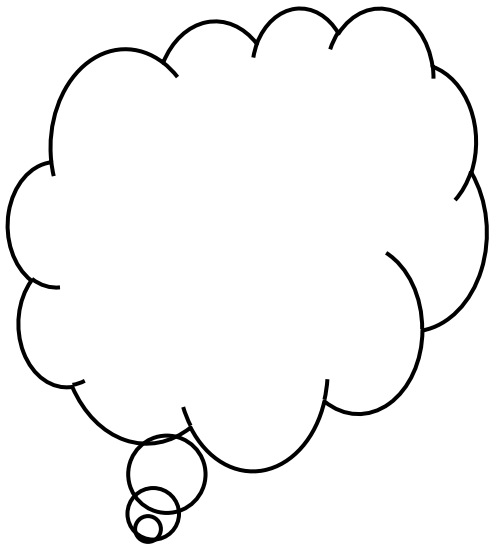
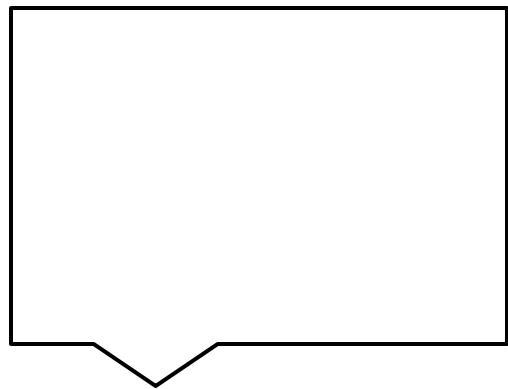
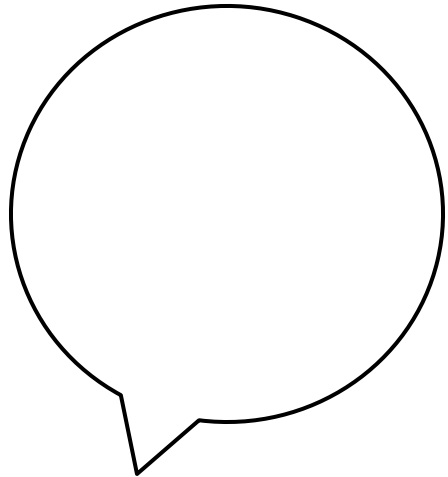
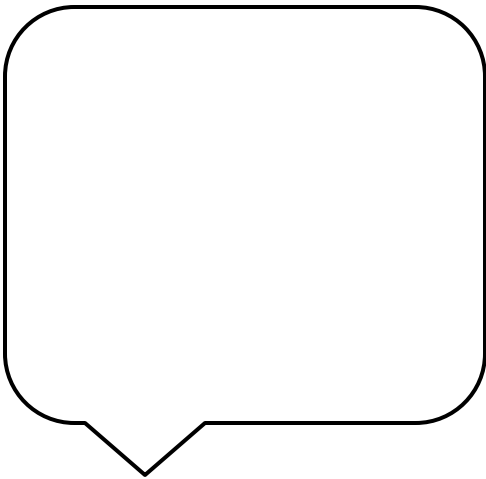

Swinging Ovals –
Cut out and add attach with a brad at the holes.

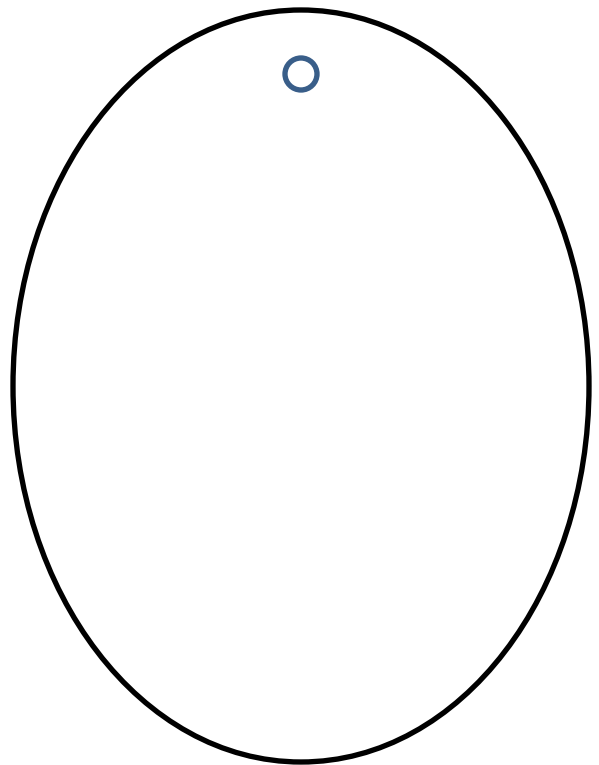
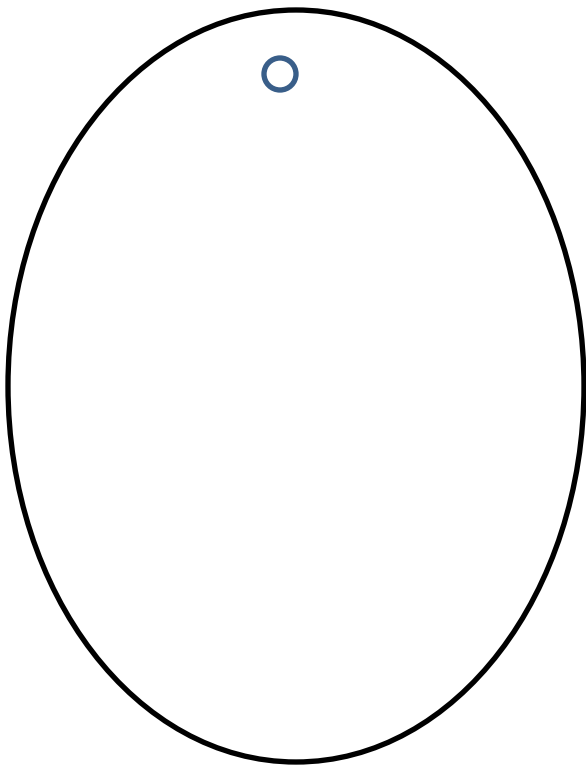
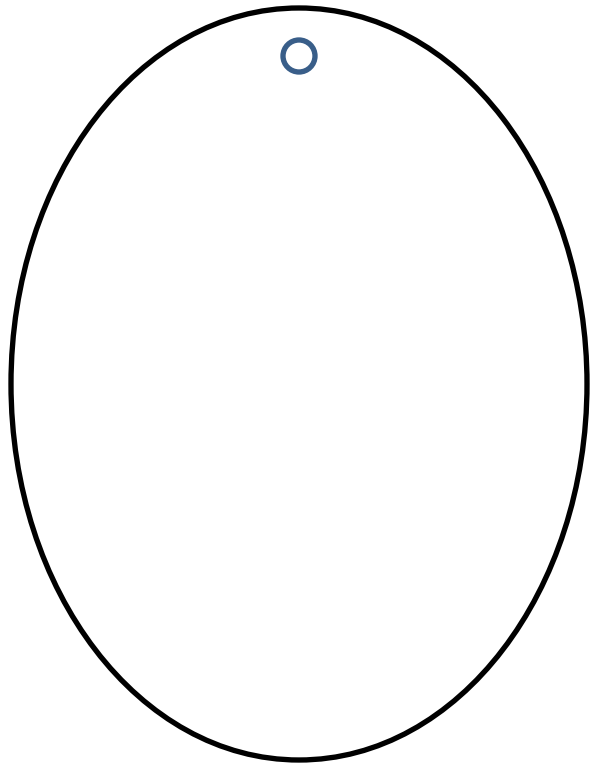
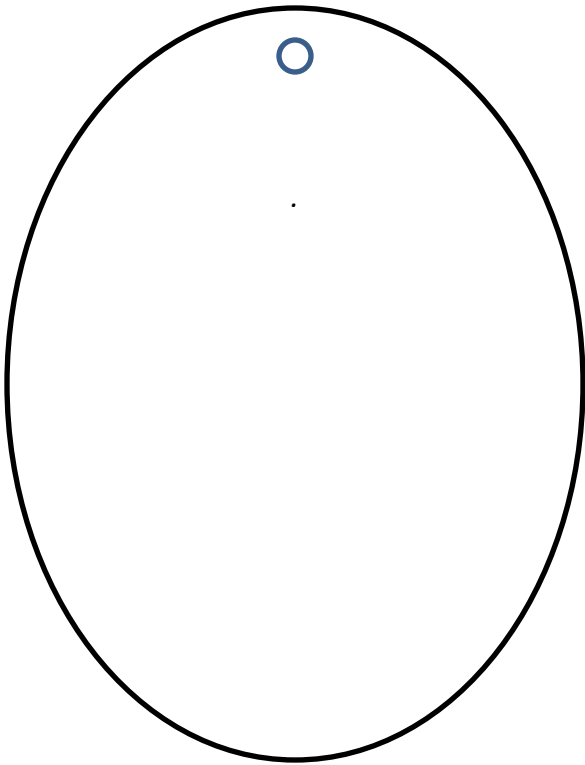

Stackable Book –
Cut out the four pieces and stack them
with smallest on top and the
largest on the bottom. Staple or glue the
tops.

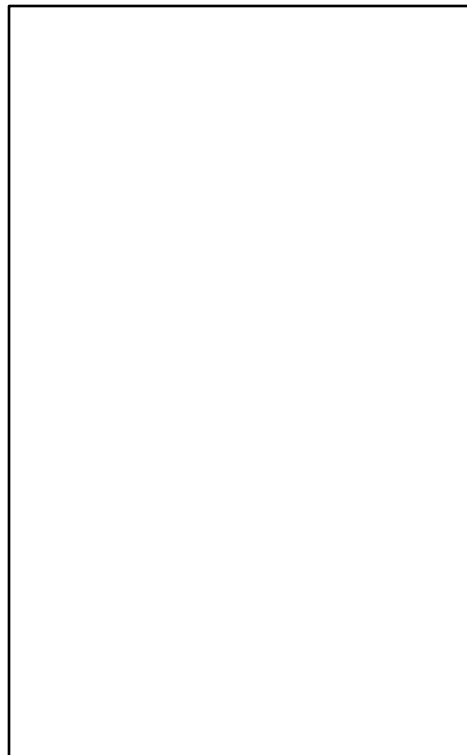
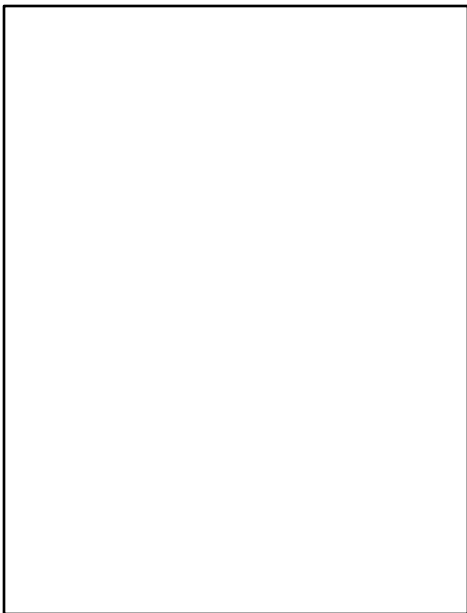
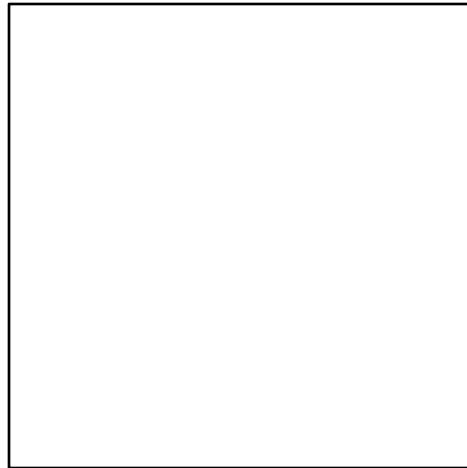
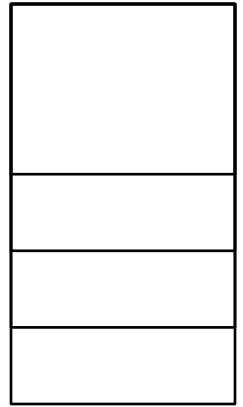

Wheel –

Cut out the wheels on the next two pages. Use an Exacto knife to cut out the small flap. Cut the top flap off. Secure with a brad.

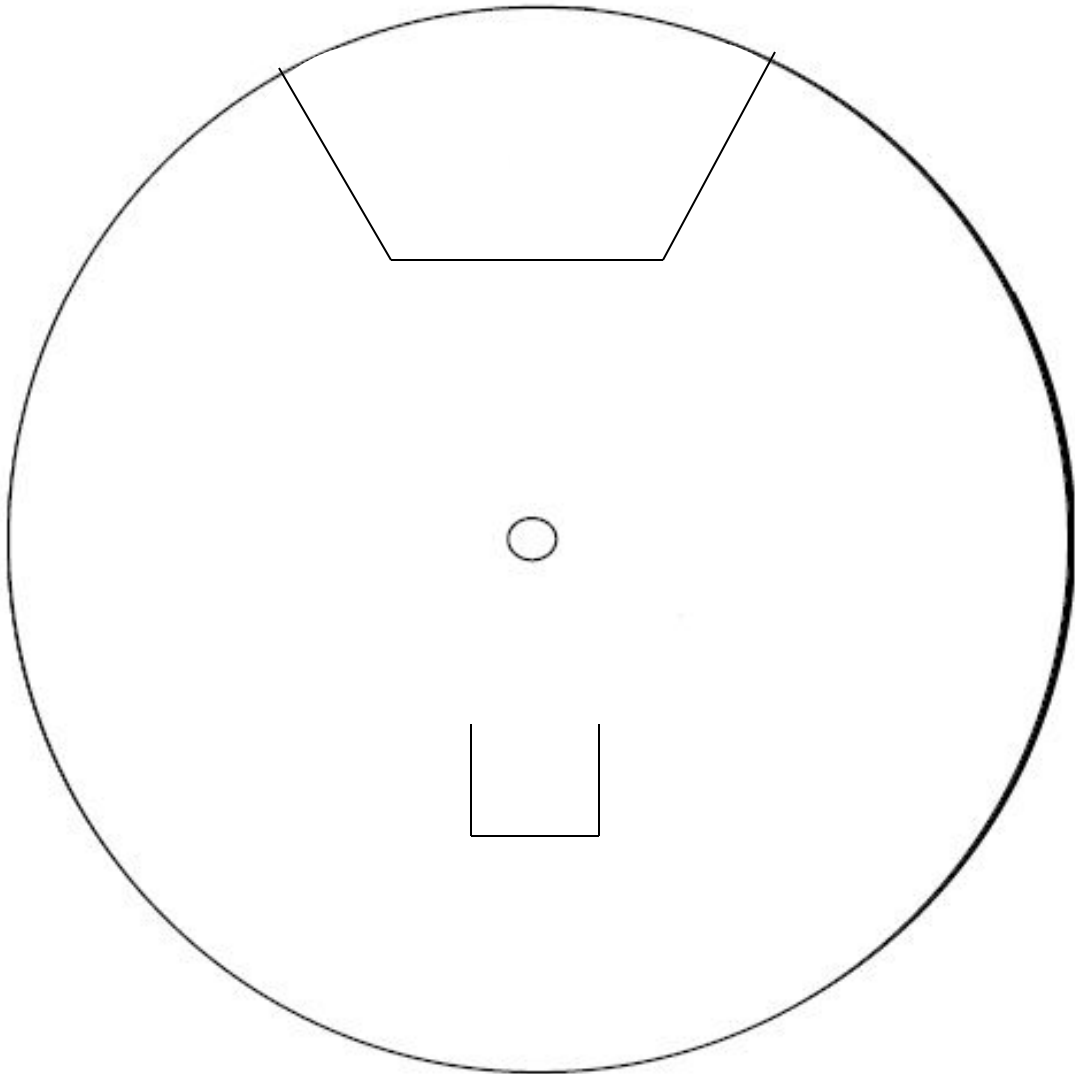

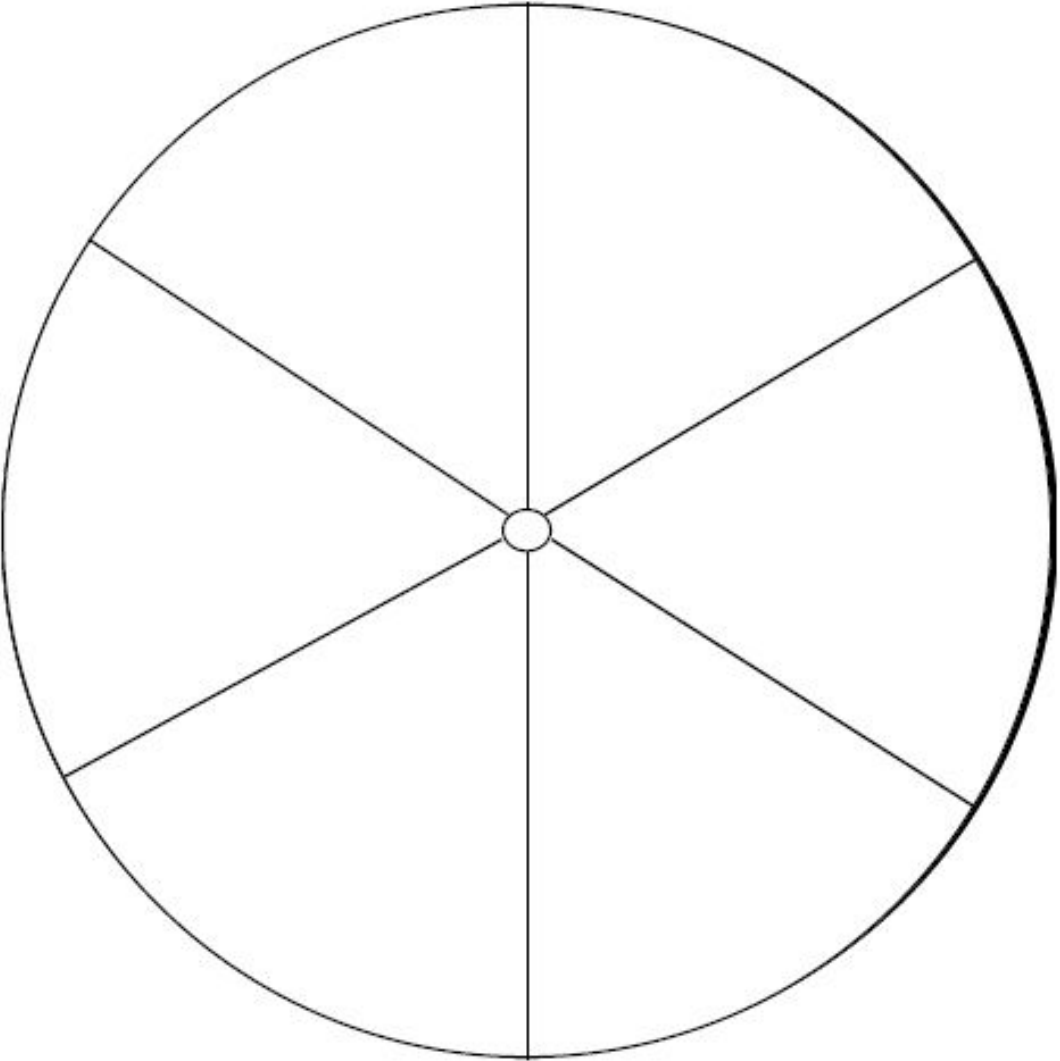

Mini File Folders –
Cut out each folder and fold on the dotted lines.

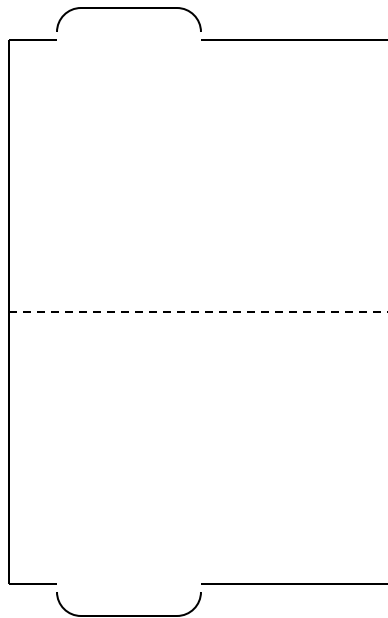
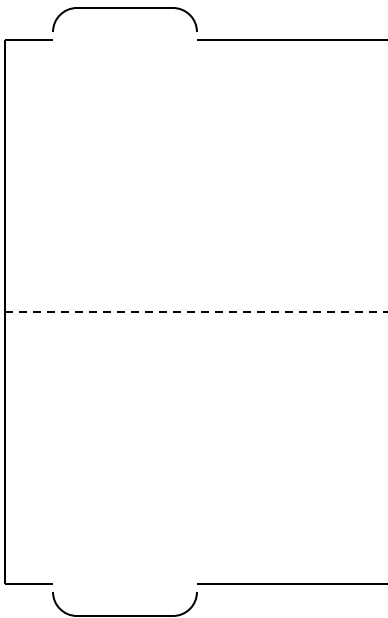
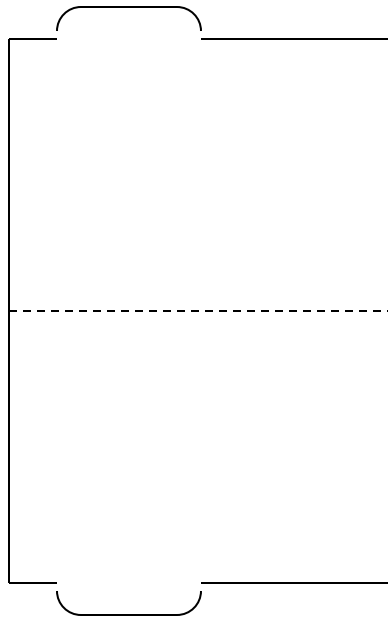
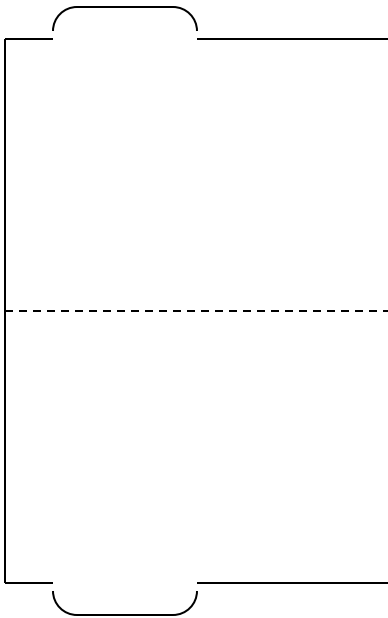

Petal Book –
Cut out as one piece and fold the petals inward. Glue the back
to the folder.

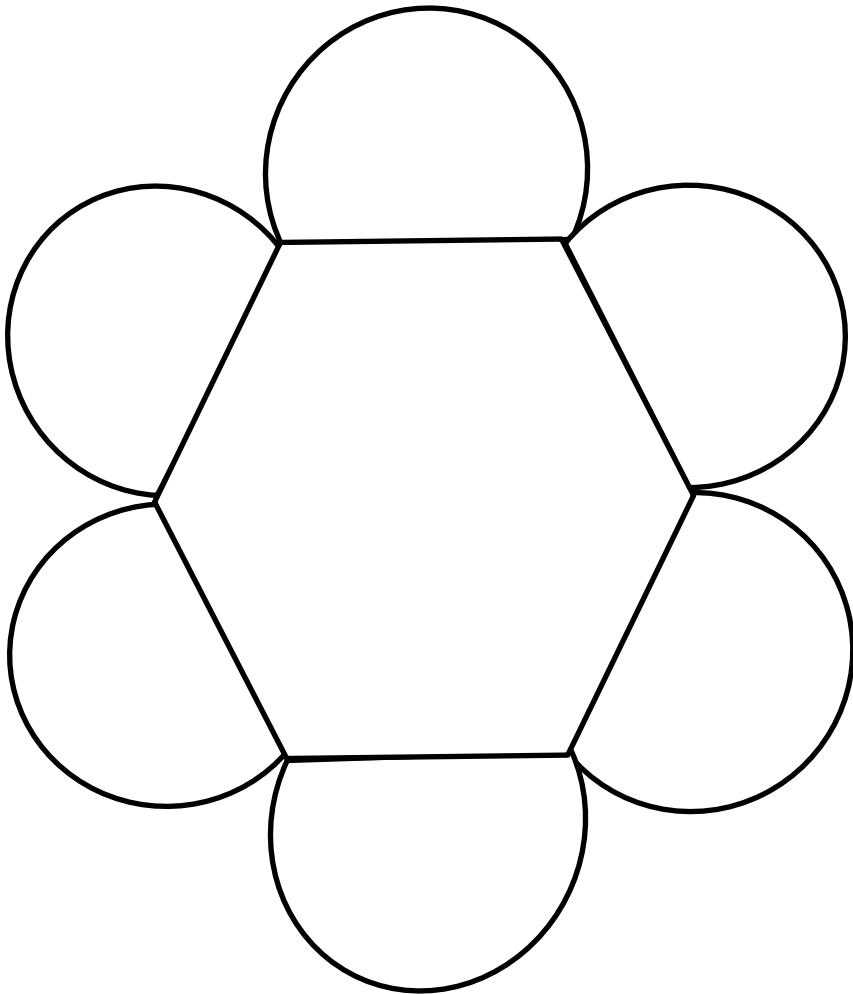

Surf Board Book –
Cut out each, stack, and secure with a brad.

