Sissejuhatus informaatikasse

Järgmiste loengute struktuur

- Loengud algavad riistvara tasemelt (alates transistorist) ja liiguvad üha suurema abstraktsuse suunas:
 - Riistvara
 - Protsessori programmeerimine, assembler
 - Kõrgkeeled: mugavam programmeerimine
 - Suurte rakendussüsteemide kokkupanek, opsüsteem, komponentide kasutamine
 - Võrgurakenduste kokkupanek: hulga arvutite kui rakenduse komponentide kasutamine
 - Eriti võimsad kõrgkeeled, funktsionaalne ja loogiline programmeerimine
 - Teooriat: keerukus, lahenduvus: mida saab kui ruttu arvutada, mida saab üldse arvutada
 - Tehisintellekt
 - IT äri ja juhtimine: kuidas raha saada

Olulisi põhimõtteid “abstraktsioonide” osas

- Kõrgkeeled, komponendid, võrguvärk jms on vajalik ainult selleks, et arendaja saaks rakendusi kiiremini teha.
- Arendaja mõtleb abstraktsioonide tasemel, aga lõpuks töötab kõik ikkagi transistoridel.
- **Abstraktsioonid nõ “tilguvad läbi”**: iga abstraktsiooni juures on vaja põhimõtteliselt aru saada, kuidas töötab alumine, vähem abstraktne tase. Alati on vahel vaja midagi allpool teha!!!
- Arendajal on reeglina kalduvus üle-abstraheerida! Süsteemi ehitamisel tuleb ise, meelega vähem abstraheerida, kui tahaks. Näiteks ei õnnestu enamasti tarkvara taaskasutus jne jne ...
- Loe juurde: The law of leaky abstractions:
<http://www.joelonsoftware.com/articles/LeakyAbstractions.html>

Ülevaade loengust

Tarkvara tööpõhimõtted ja programmeerimiskeelte hierarhia

- Riistvara:
 - Riistvara komponendid
 - Protsessori tööpõhimõte
- Programmeerimiskeelte hierarhia ja mehaanika (jätkub järgmine loeng)
 - Assembler
 - C
 - C ja assembler
 - C ja mäluhaldus
 - Kõrgema taseme keeled
 - Prahikoristus
 - Listid
 - Keeled

Näpuga lüliti

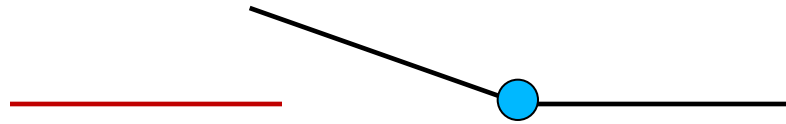

Vool läbi ei lähe

Elekter
siit
sisse

Vajuta
näpuga

Elekter
siit
välja?

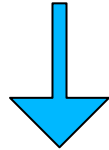

Vool läheb läbi

Relee: mootoriga lüliti

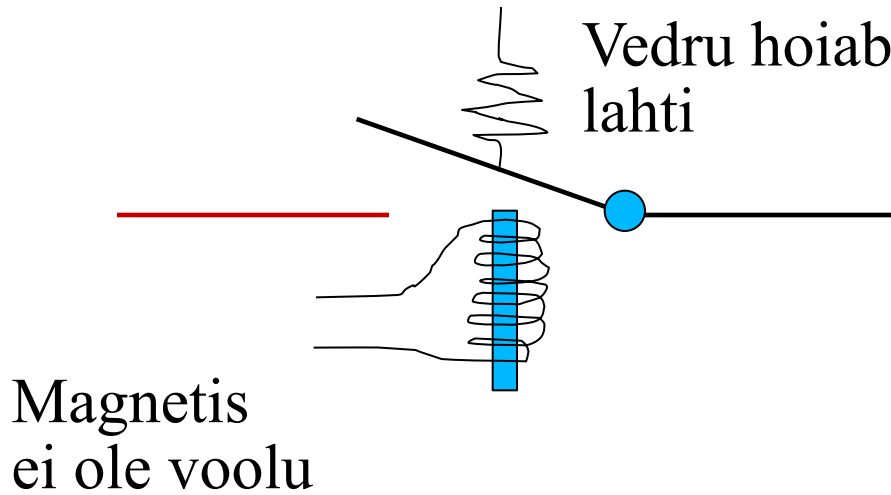

Vool läbi ei lähe

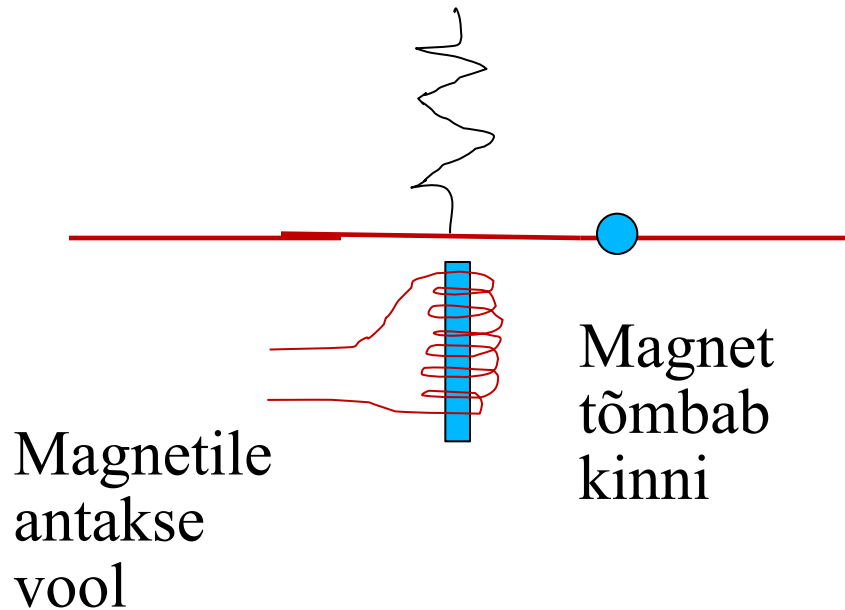

Vool läheb läbi

Miks releed? Näide.

Realiseerime lausearvutuse valemi $\text{Not } (A \& B)$ releedega:

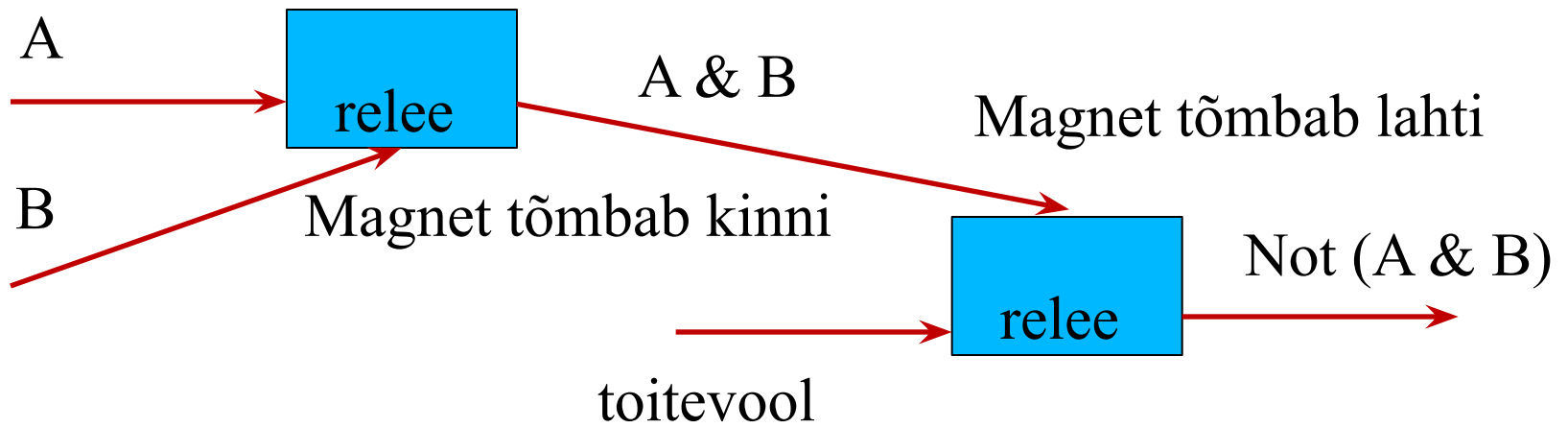

Keerukamaid asju, näiteks liitmist ja korrutamist, ehitatakse suure hulga lausearvutuse tehetena umbes samal moel.

Komponendid

- Peamine idee: transistorid kui “katkestusmootoriga” lülitid

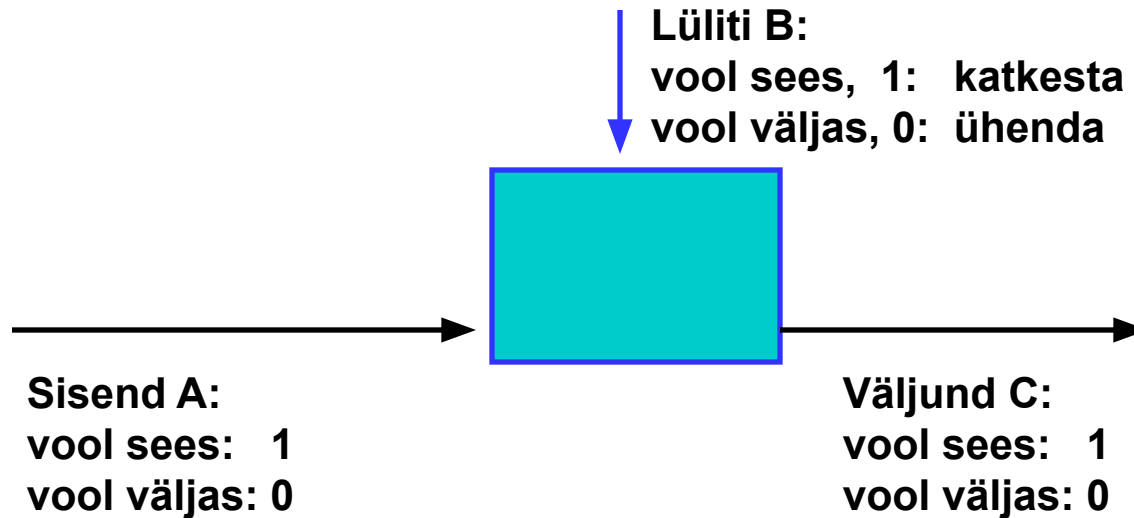

$$C = (A \text{ and } -B)$$

- Väikestest komponentidest ehitatakse suuremaid, millest omakorda veel suuremaid.
- Komponendid on kui mustad kastid: teame nende väljundit vastava sisendi korral, aga enamasti mitte nende tehnilist sisu.

Logic gates: simple idea

- MOSFET: metal-oxide semiconductor field-effect transistor
- Input near 2V: circuit on. Input near 0V: circuit off.

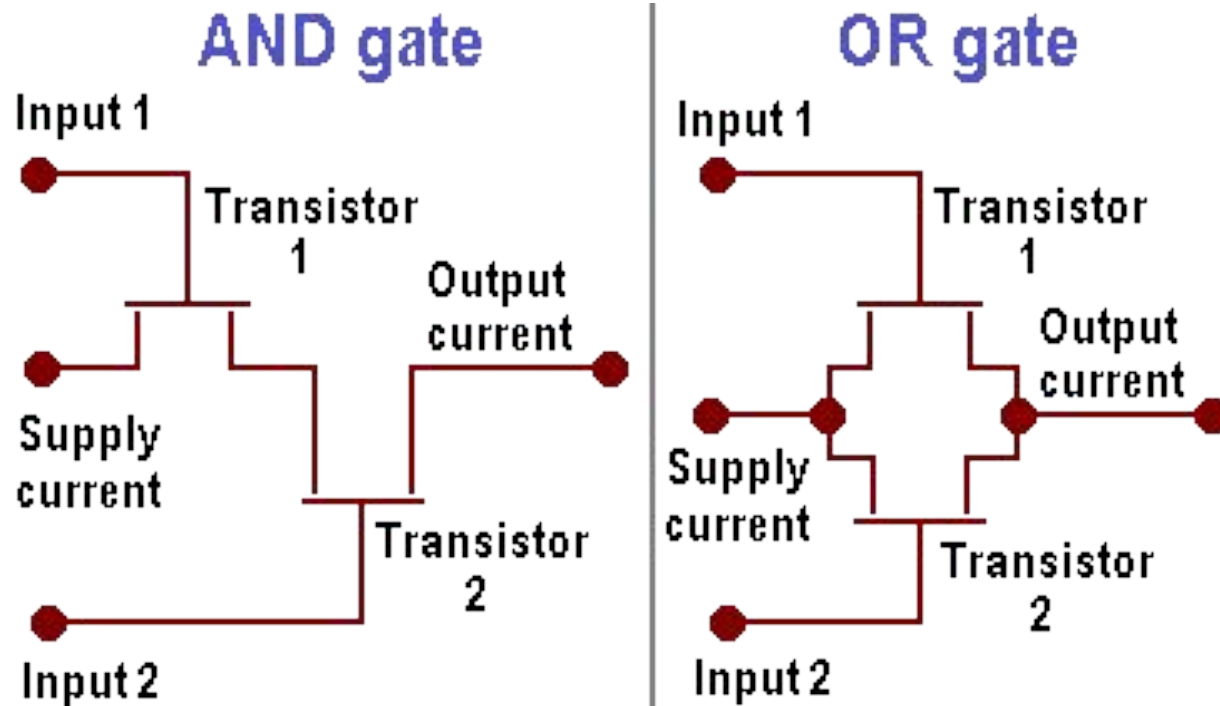

Komponendid (Eck)

(A and C) or (B and (not C))

Click here to rotate a gate into one of four positions.

Sample circuit using all six components. The power is on. The output at the bottom, one of the inputs, and several wires are in the ON state.

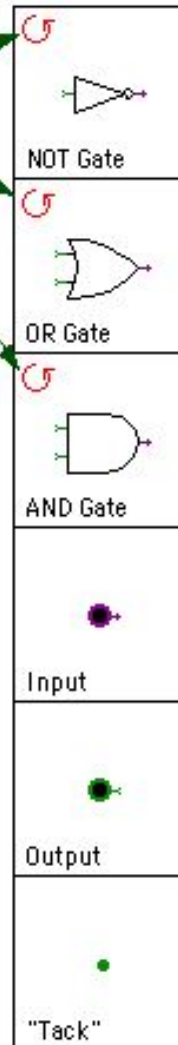
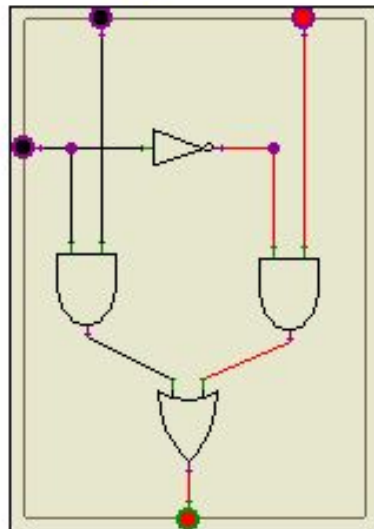

NOT gate turns its output ON when its input is OFF, and vice versa. A NOT gate reverses its input.

AND gate turns its output ON when both of its inputs are ON. Otherwise, the output is OFF.

OR gate turns its output ON when either of its inputs is on (or when both are ON).

Inputs can be placed around the edges of a circuit to provide input values for the circuit as a whole.

Outputs can be placed around the edges of a circuit to represent values computed by the circuit as a whole.

Tacks are simply connecting points for wires, which can be used to help make your circuits neater.

Komponendid (Eck)

(A and (not B)) or (B and (not A))

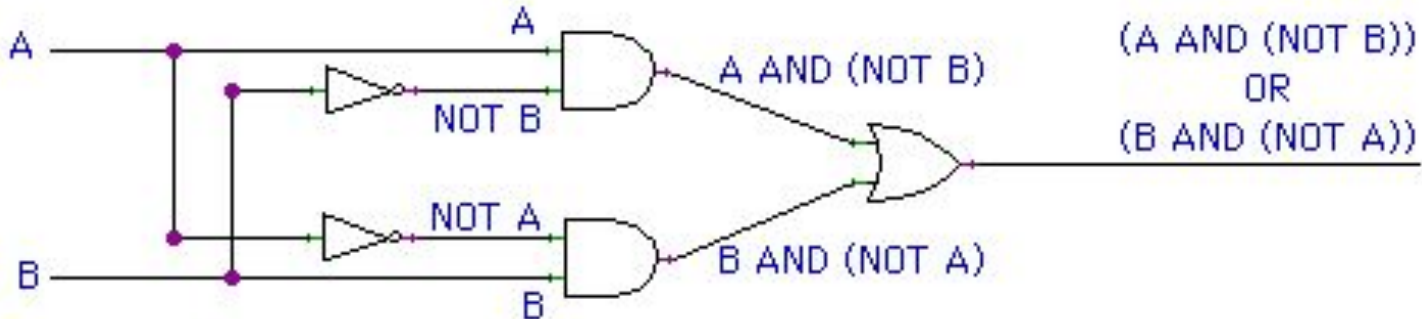

- **Steps:**
 - Find variables that are used and organise inputs for those at the left
 - Divide the formula into logical operations specifying the sequence of execution
 - “Implement” those operations in the order identified at the previous step using necessary inputs (*for example “B & not A” needs and input from “B” and from “not A”*)
- <http://math.hws.edu/TMCM/java/labs/xLogicCircuitsLab1.htm>
- <http://math.hws.edu/TMCM/java/labs/xLogicCircuitsLab2.html>

Komponendid (Eck)

(A and C and (not B)) or (A and (not C)) \Leftrightarrow **(A and (C and (not B))) or (A and (not C))**

Steps:

- Find variables that are used and organise inputs for those at the left
 - A, B, C
 - Divide the formula into logical operations specifying the sequence of execution:
Grey color shows what we already know (either given or already calculated)
 - not B
 - C and (not B)
 - A and (C and (not B))
 - not C
 - A and (not C)
 - (A and (C and (not B))) or (A and (not C))
 - “Implement” those operations in the order identified at the previous step using necessary inputs (for example “B & not A” needs and input from “B” and from “not A”)
-
- **A**
 - **B**
 - **C**
-
- The diagram illustrates the implementation of the logical expression $(A \text{ and } C \text{ and } (\text{not } B)) \text{ or } (A \text{ and } (\text{not } C))$. It shows three input lines: A, B, and C. B and C are inverted to produce *not B* and *not C*. *not B* and C are ANDed to produce *C and (not B)*. *not C* and A are ANDed to produce *A and (not C)*. *C and (not B)* and A are ANDed to produce *A and (C and (not B))*. Finally, *A and (C and (not B))* and *A and (not C)* are ORed to produce the final output *A and (C and (not B)) or (A and (not C))*.

Neljabitine liitja (four-bit adder)

- Kaheksa pluss kaks sisendjuhet, neli pluss üks väljundjuhet

| | | | | | |
|-------|-------|-------|-------|-------|-------|
| 1011 | 1111 | 1111 | 1010 | 0111 | 0001 |
| 0110 | 0001 | 1111 | 0101 | 1010 | 0011 |
| ----- | ----- | ----- | ----- | ----- | ----- |
| 10001 | 10000 | 11110 | 01111 | 10001 | 00100 |

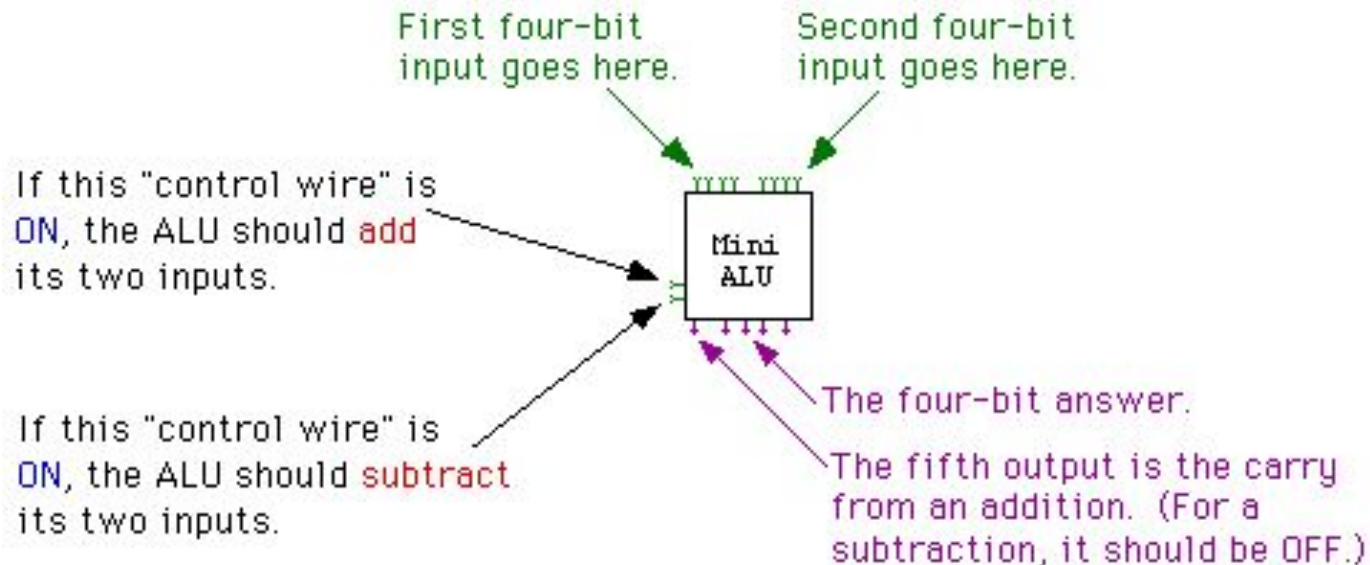

- Tagasiside

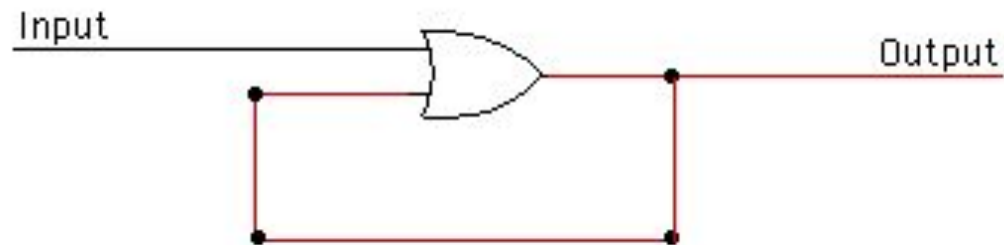

- Lülitatav tagasiside: triger

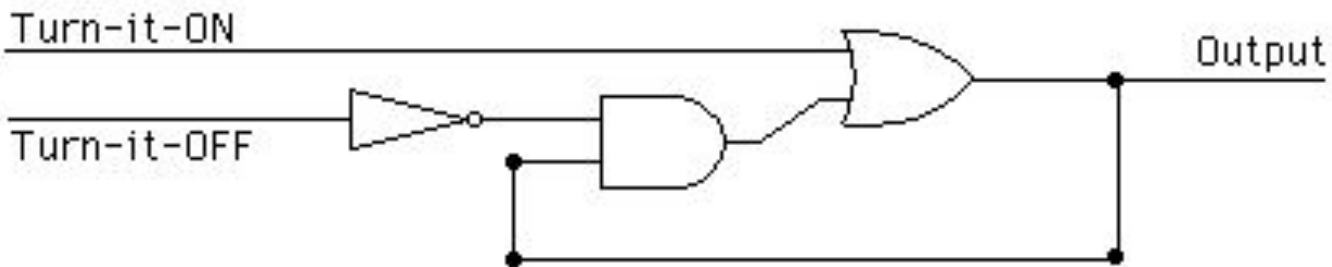

Mälu

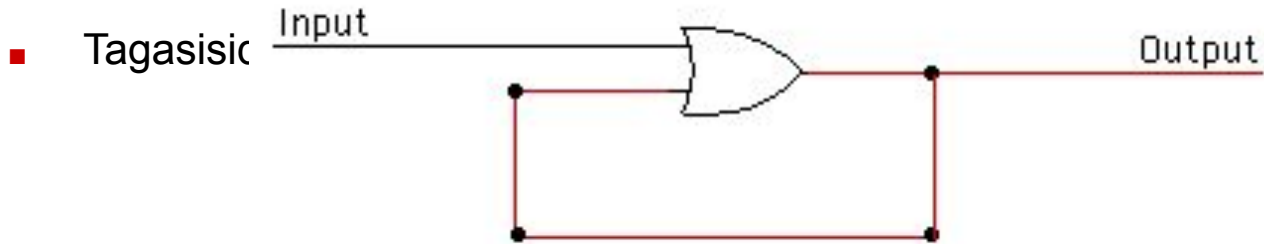

- Kuidas töötab

| <i>t</i> | 1 | 2 | 3 |
|--------------------|---|---|---|
| Input | 0 | 1 | 0 |
| Output as feedback | 0 | 0 | 1 |
| Output | 0 | 1 | 1 |

Result of:

“Input” or “Output as feedback”

Mälu

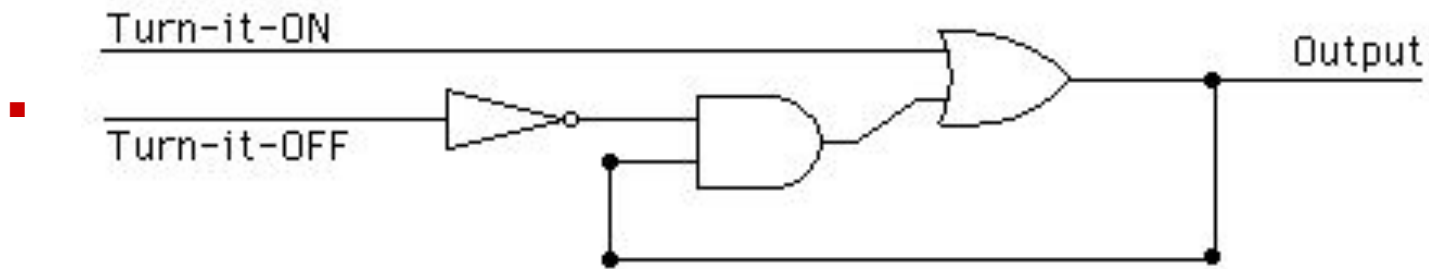

- Kuidas töötab

| t | 0 | 1 | 2 | 3 | 4 | 5 | ... |
|--------------------|---|---|---|---|---|---|-----|
| Input "On" | 0 | 1 | 0 | 0 | 0 | 0 | |
| Input "Off" | 0 | 0 | 0 | 0 | 1 | 0 | |
| Output as feedback | 0 | 0 | 1 | 1 | 1 | 0 | |
| Output | 0 | 1 | 1 | 1 | 0 | 0 | |

Ühebitine mälukiip

- Kaks sisend- ja üks väljundjuhe

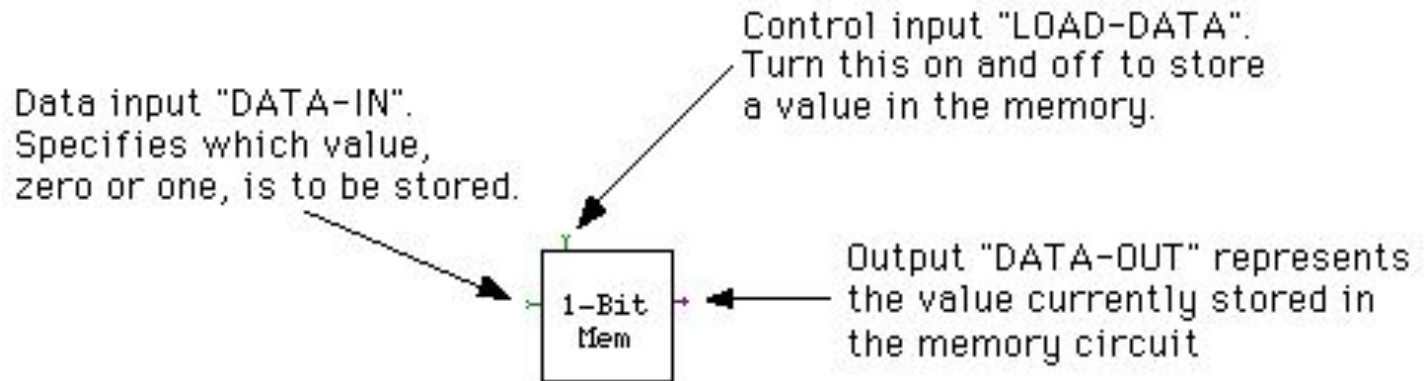

Guarded 1-bitine mälukiip

- Ekstra lüliti kiibi sisse või väljalülitamiseks

DATA-IN, LOAD-DATA, and DATA-OUT wires have the same functions as in the basic 1-Bit Mem.

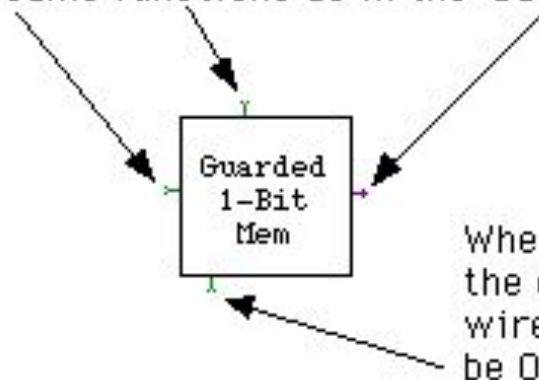

When this GUARD control wire is OFF, the output is OFF and the LOAD-DATA wire has no effect. The GUARD must be ON to store or read data.

RAM

- Random-access memory

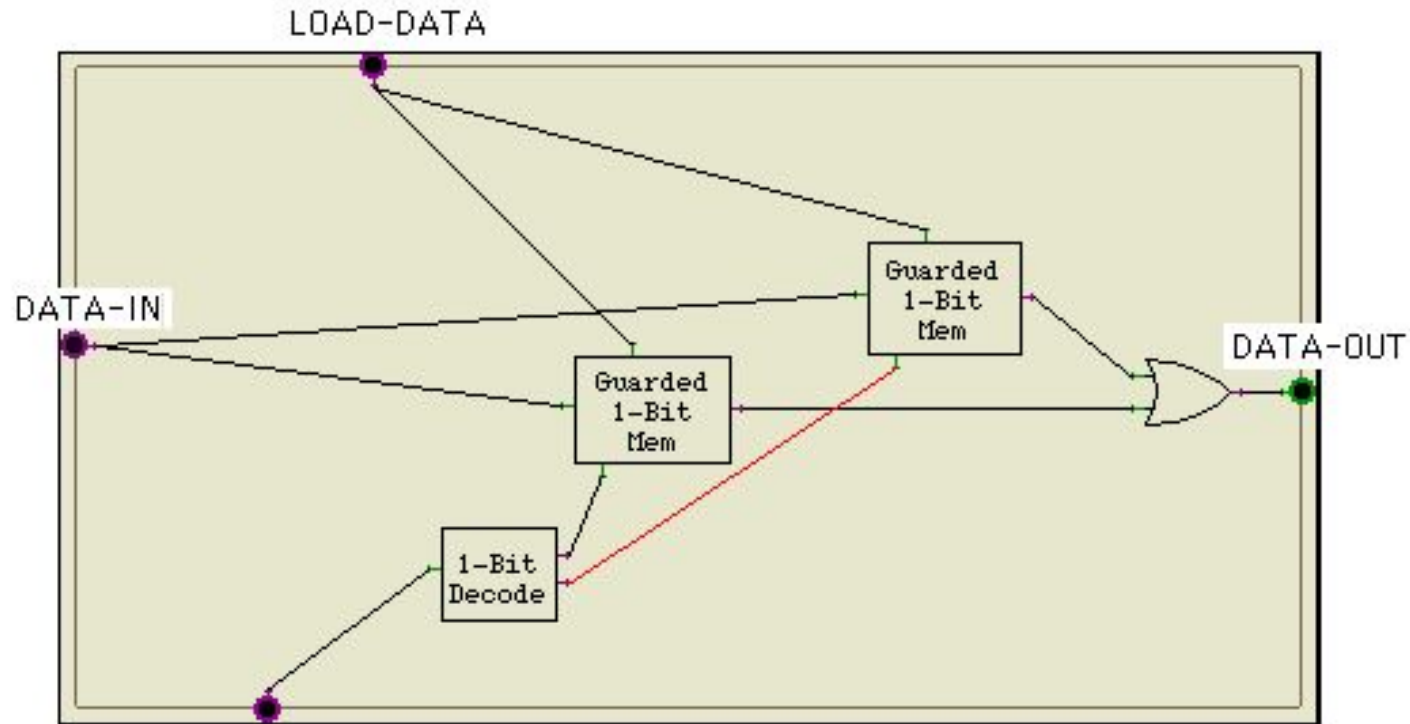

ADDRESS wire is used to select which location is to be used for storing or reading data.

Ecki xComputer

- <http://math.hws.edu/TMCM/java/labs/xComputerLab1.html>
- Arvuti põhiosade (protsessor + mälu) simulatsioon väikese Java programmiga.
- Käsusüsteem sarnaneb väga esimeste päris-mikroprotsesoriga
- Lihtsama arusaadavuse tõttu kasutab kahebaidiseid mälupesid (16 bitti), mitte ühebaidiseid, nagu harilik arvuti.
- Mälu on 1024 pesa (1 K), seega 2 Kbaiti.
- Aadressi jaoks kasutatakse 10 bitti.
- Esimestel koduarvutitel oli ka 4-16 Kbaiti (umbes sama hulk mälu)
- Olulist: protsessori sees on väike hulk spetsiaal-mälupesid (registrid)
- Tehteid saab teha ainult nende registrite vahel.
- Ei ole näiteks võimalik liita otse kahte mälus olevat arvu: enne tuleb nad registritesse kopeerida, siis seal liita, siis tulemusregistrist (nn akumulaator) mäll kirjutada.
- Koha, kust mälust loetakse/kirjutatakse näitab ADDR register.
- Koha, kust lugeda järgmine käsk, näitab PC (program counter) register

Käskude täitmine

- **Kaks tsüklit üksteise sees:**
- **Välimine tsükkel** suurendab igal ringil PC-d (program counterit), st igal ringil võetakse täidetav käsk järgmisest mälupeasast.
 - **Sisemine tsükkel** toimub iga käsu sees. Sisemise tsükli jooksul täidetakse käsu sisemisi pisi-samme.

Üks pisi-samm vastab mingile juhtmele voolu peale andmisele, mispeale käivitub vastav loogika-ahel protessoris ja selle tulemus salvestatakse mõnda registrisse.

- **Masina taktsagedus** on see sagedus, kui tihti pisi-samme täidetakse. Iga järgmise pisi-sammu alustamise jaoks on masinas kell, mis annab kindla sagedusega impulsse. Pisi-sammu number saadakse nende impulsside kokkulugemisega.

Protsessori põhiregistrid

- The **X and Y registers** hold two sixteen-bit binary numbers that are used as input by the ALU. For example, when the CPU needs to add two numbers, it must put them into the X and Y registers so that the ALU can be used to add them.
- The **AC** register is the accumulator. It is the CPU's "working memory" for its calculations. When the ALU is used to compute a result, that result is stored in the AC. For example, if the numbers in the X and Y registers are added, then the answer will appear in the AC. Also, data can be moved from main memory into the AC and from the AC into main memory.
- The **FLAG** register stores the "carry-out" bit produced when the ALU adds two binary numbers. Also, when the ALU performs a shift-left or shift-right operation, the extra bit that is shifted off the end of the number is stored in the FLAG register.

... Registrid ...

- The **ADDR** register specifies a location in main memory. The CPU often needs to read values from memory or write values to memory. Only one location in memory is accessible at any given time. The ADDR register specifies that location. So, for example, if the CPU needs to read the value in location 375, it must first store 375 into the ADDR register. (If you turn on the "Autoscroll" checkbox beneath the memory display, then the memory will automatically be scrolled to the location indicated by the ADDR register every time the value in that register changes.)
- The **PC** register is the program counter. The CPU executes a program by fetching instructions one-by-one from memory and executing them. (This is called the fetch-and-execute cycle.) The PC specifies the location in memory that holds the next instruction to be executed.
- The **IR** is the instruction register. When the CPU fetches a program instruction from main memory, this is where it puts it. The IR holds that instruction while it is being executed.

... Registrid ...

- The **COUNT** register counts off the steps in a fetch-and-execute cycle. It takes the CPU several steps to fetch and execute an instruction. When COUNT is 1, it does step 1; when COUNT is 2, it does step 2; and so forth. The last step is always to reset COUNT to 0, to get ready to start the next fetch-and-execute cycle. This is easier to understand after you see it in action. Remember that as the COUNT register counts 0, 1, 2, ..., just one machine language program is being executed

... Regidrid ...

- **lod-c 17 into some memory location**
- COUNT becomes 1, indicating that the first step in the fetch and execute cycle is being performed. **The value in the PC register is copied into the ADDR register.** (The PC register tells which memory location holds the next instruction; that location number must be copied into the ADDR register so that the computer can read that instruction from memory.)
- COUNT becomes 2. An **instruction is copied** from memory **into the IR.** (The ADDR register determines which instruction is read.) In this case, the instruction is Lod-c 17.
- COUNT becomes 3. The value in the **PC register is incremented by 1.** Ordinarily, this prepares the PC for the **next** fetch-and-execute cycle. This completes the "fetch" portion of the fetch-and-execute cycle. The remaining steps in the cycle depend on the particular instruction that is begin executed (in this case, lod-c 17).
- COUNT becomes 4. **The data part of the instruction in the IR register, is copied into the accumulator.** In this case, the value is 17. This is the only step necessary to execute the lod-c 17 instruction.
- COUNT becomes 5, but only briefly. The Set-COUNT-to-Zero control wire is turned on and immediately the value of **COUNT is reset to 0.** One fetch-and-execute cycle is over.

... Regstrid ...

Lets say we have the following part of a program where No. X means an address of that program step (memory location of the step instruction) and A, B mean addresses in the memory, and lets say that + is an instruction with a code 001

No 101.

No 102. $A=B+3$ (Actually $A=B$ 001 3)

No 103.

It is done using the following steps:

- COUNT becomes 1, indicating that the first step in the fetch and execute cycle is being performed. **The value in the PC register is copied into the ADDR register (102).**
- COUNT becomes 2. An **instruction is copied** from memory into the IR (001).
- COUNT becomes 3. An address for the left variable is copied into **ADDR register (B)**.
- COUNT becomes 4. A value found at that address (**B**) is copied into **X register**
- COUNT becomes 5, **3** (the right variable, which is a constant) is copied into **Y register**
- COUNT becomes 6. The value in the **PC register is incremented by 1**.
- COUNT becomes 7. The instruction from the **IR register (001)** is executed and the result is copied into **AC register**; **FLAG register** is also loaded to show special cases (whether *div by 0* occurred? etc.).
- COUNT becomes 8. An address for the result variable is copied into **ADDR register (A)**.
- COUNT becomes 9. A value from **AC register** is copied into that address (**A**).
- COUNT becomes 10, but only briefly. The Set-COUNT-to-Zero control wire is turned on and immediately the value of **COUNT is reset to 0**. One fetch-and-execute cycle is over.

Hierarhia pistikutest progekeelteni

- Esimene: programmeerimismeetod: kaablid ja pistikud
- Teine: von Neumanni arhitektuur, programm mälus binaarkoodina:

01011101 01001011 01010101 11010101 10101001 ..

Lihtsam kirjutada hexas, nt 4A FC 09 B2

- Kolmas: Esmane progekeel: assembler.

Üks masinakäsk: tüüpiliselt üks rida assembleriprogrammi

- Neljas: Harilik progekeel ehk nn kõrgkeel (fortran, basic, c, java, jne).

Harilikud valemid, if-then-else jne, a la $x=2*y+\sin(y)$;

| | | |
|------|---|---|
| 0000 | = | 0 |
| 0001 | = | 1 |
| 0010 | = | 2 |
| 0011 | = | 3 |
| 0100 | = | 4 |
| 0101 | = | 5 |
| 0110 | = | 6 |
| 0111 | = | 7 |
| 1000 | = | 8 |
| 1001 | = | 9 |
| 1010 | = | A |
| 1011 | = | B |
| 1100 | = | C |
| 1101 | = | D |
| 1110 | = | E |
| 1111 | = | F |

Assembler: sumto / Intel x86

- Argumendid registris BX
- Resultaat registrisse AX

```
sumto:    MOV AX, 0        ;sum = 0
          MOV CX, BX      ;CX is used for loop
L1: ADD AX, 1
          SUB CX, 1
          JNZ L1
          ...
```

Kõrgkeeled

- **Automatiseerivad ja lihtsustavad** hulga “harilikke” protseduure, mida assembleris programmeerides vaja
- Ei anna assembleriga analoogilist kontrolli masina üle
- Kõrgkeeled on erineva abstraktsusastmega:
 - Masinalähedane ja ebamugav: Fortran, C (portaabel assembler)
 - Abstraktsem ja mugavam: Lisp, Ada, ML, Java, Python,
- **Peale programmeerimiskeelte on veel hulk muid keeli:**
 - Päringukeeled (SQL, RDQL,)
 - Kujunduskeeled (HTML, PS, ...)
 - Spetsifitseerimiskeeled (loogikakeeled, UML,)
 -

Programming is linguistic

- **Programming is an explanatory activity.**
 - To yourself, now and in the future.
 - To whoever has to read your code.
 - To the compiler, which has to make it run.
- **Explanations require language.**
 - To state clearly what is going on.
 - To communicate ideas over space and time.

Languages are essential

- Therefore **languages** are of the essence in computer science.
 - Programming languages, in the familiar sense.
Fortran, C, Java, C#, Python, Javascript etc.
 - Description languages (not for programming):
 - Text layout: html
 - Html layout nuances: css
 - Database query tasks: SQL
 - Data representation: XML
 - ... etc

Keeled: tüüpilised asjad, mida pea iga keel pakub

■ Primitiivsed andmetüübid:

- int, char etc (näiteks: 1 ja -3 on int-id, 'c' ja 'a' on char-id)
- string (näiteks "aaa123bb")
- massiiv (näiteks $a[1]=2$; $a[2]=20$; $a[3]=15$; $y=2$; $x=a[y]+a[1]+3$;))

■ Avaldised:

- näiteks $x = (y*2) - (5+x)$;

■ Elementaarsed juhtkonstruktsioonid:

- valik: if ... then ... else
- tsükel: while($x < 10$) $x = x + 1$;

■ Funktsioonid:

- defineerime: $\text{int kuup}(\text{int } x) \{ \text{return } x * x * x \}$
- kasutame: $x = \text{kuup}(1 + \text{kuup}(3)) + \text{kuup}(y)$;
- kasutame rekursiivselt:

$\text{int fact}(\text{int } x) \{ \text{if } (x \leq 0) \text{ return } 1; \text{ else return } x * (\text{fact}(x-1)); \}$

Keeled: näited lisavõimalustest eri keeltes

- Kiired bitioperatsioonid, otsepöördumine mälu kallale: C
- Keerulisemad andmetüübid: listid, hash tabelid jne: Lisp, Python, Javascript
- Erikonstruktsioonid stringitötluseks: Perl, PHP

- Objektid: C++, Java, C#, Python, Lisp
- Moodulid (enamasti ühendatud objektidega): C++, Java, C#
- Veatötluse konstruktsioonid (exceptions): Python, Java, C#

- Prahikoristus: kasutamata andmed visatakse välja (Java, Python, Lisp, ...)
- Sisse-ehitatud tugi paralleelprogrammide jaoks: Java, C#
- Reaalaja-erivahendid: Ada

- “Templates” (programm tulemuse sees): PHP, JSP, Pympl
- Uute programmide konstrueerimine töö käigus: Lisp, Scheme, Javascript
- Loogikareeglid: Prolog
- “laisk” viis funktsioone arvutada: Miranda, Hope, Haskell
- Pattern matching (viis funktsioone defineerida): ML, Haskell
- **jne...**

Programmeerimiskeelte paradigmad

- **Vaade 1:** kolm peamist teoreetilist algoritmikeelte paradigmat:

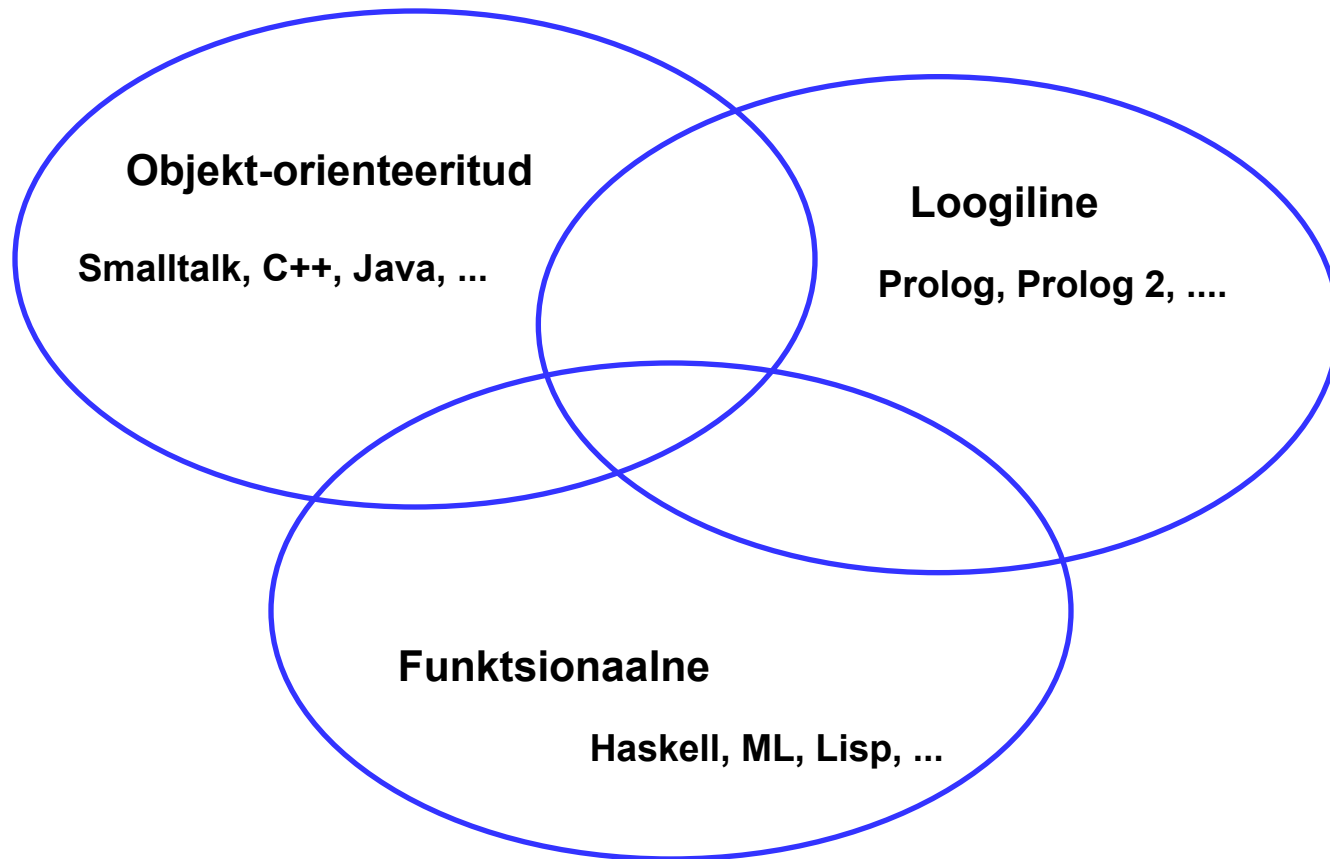

Keelte erisused: kolm põhiasja

- **Süntaks** (kuidas kirjutatakse näiteks **if .. then .. else** ühes või teises keeles)
- **Semantika** ehk tähendus (mida õigesti kirjutatud programm tegelikult siis teeb)
- **Teegid (libraries)** (millised **valmisprogrammijupid** on selle keele jaoks kergesti kättesaadavad või kohe kaasa pandud)

- FORTRAN

```
INTEGER FUNCTION sumto(n)
  isum = 0
  DO i 10 = 0,n
    isum = isum + i
10 CONTINUE
  sumto = isum
  RETURN
END
```

Sumto ja Modula-2

- Modula-2

```
PROCEDURE sumto (n:INTEGER) : INTEGER;  
VAR sum, i:INTEGER;  
BEGIN  
    sum:=0;  
    FOR i:=0 TO n DO  
        sum:=sum+i  
    END;  
    RETURN sum  
END sumto;
```

- C (ja C++ ja Java ja C#)

```
int sumto(int n) {  
    int i, sum = 0;  
    for(i=0; i<=n; i=i+1)  
        sum = sum + i;  
    return sum;  
}
```

Kuidas keeles X kirjutatud programmi täidetakse?

NB! arvuti suudab täita ainult masinkoodis programme.

Kaks põhivarianti keeles X programmi täitmiseks.

- **Kompileerimine:** masinkoodis programm nimega kompilaator teisendab keeles X programmi masinkoodfailiks Y. Seejärel täidetakse saadud masinkoodis programm Y. Näide: C.
- **Interpreteerimine:** masinkoodis programm nimega interpretaator loeb sisse X keeles faili, kontrollib/ veidi teisendab teda ja asub nõ sisekujul varianti rida-realt täitma. Näited: Python, PHP, Perl, vanemad Javascripti mootorid jne.

NB!

- Programmi interpreteerimine on ca 10-200 korda aeglasem, kui kompileeritud koodi täitmine.
- Põhimõtteliselt saaks igas keeles kirjutatud programme nii interpreteeritult täita kui kompileerida.
- Praktikas eelistatakse vahel interpreteerimist, vahel kompileerimist.

Kuidas keeles X kirjutatud programmi täidetakse?

Kompromissvariante:

- Kompilaator kompileerib X faili **vahekoodiks** Y, seejärel interpreteeritakse vahekoodi Y (Python, Java).
- Interpretaator interpreteerib vahekoodi Y, kuid **kompileerib töö ajal osa Y-st masinkoodiks**, mida seejärel täidab (Java ja Firefox'i Javascript) nn just-in-time compilation ehk **JIT**.
- Chrome V8 Javascript: kompileerib algul kogu programmi masinkoodiks kiire kompilaatoriga, seejärel kompileerib töö käigus selgunud kriitilised kohad aeglasema optimeeriva kompilaatoriga, mis annab kiiremini töötava tulemuse.

Kompileeritava programmi valmimine

Olgu meil (näiteks C keeles) failid main.c ja swap.c

Teeme gcc main.c swap.c -o minuprogramm

Kompilaator (näiteks gcc) teeb järjest mitut eri asja:

■ **Kompileerimine**

- Kompilaator teeb neist assemblerikeelsed ajutised failid
- Kompilaator teeb assemblerfailidest masinkood+sümbolinfo failid

■ **Linkimine**

- Linkur otsib kokku vajalikud olemasolevad failid osa sümbolinfo seostamiseks päris koodi-viidetega

Käivitame saadud programmfaili minuprogramm:

- Opsüsteemi **loader** otsib lisaks vajalikud olemasolevad failid osa sümbolinfo seostamiseks päris koodi-viidetega
- Saadud kogum paigutatakse mällu, tehakse opsüsteemi infoblokk tema jaoks (protsess) ja kogum käivitatakse

(CMU Bryant & Hallaron course) Static Linking

Programs are translated and linked using a *compiler driver*:

- `unix> gcc -O2 -g -o p main.c swap.c`
- `unix> ./p`

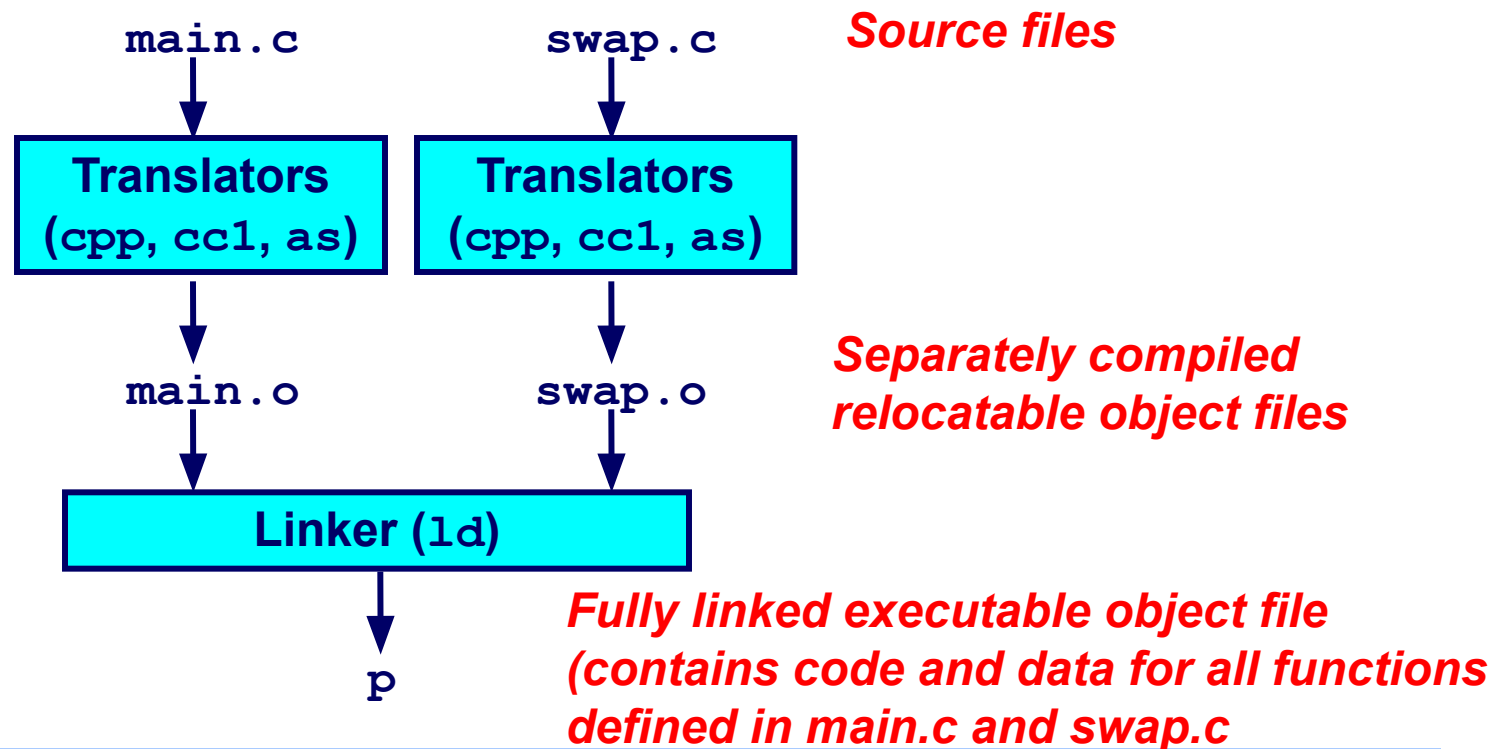

(CMU B&H ..) Static Linking and Loading

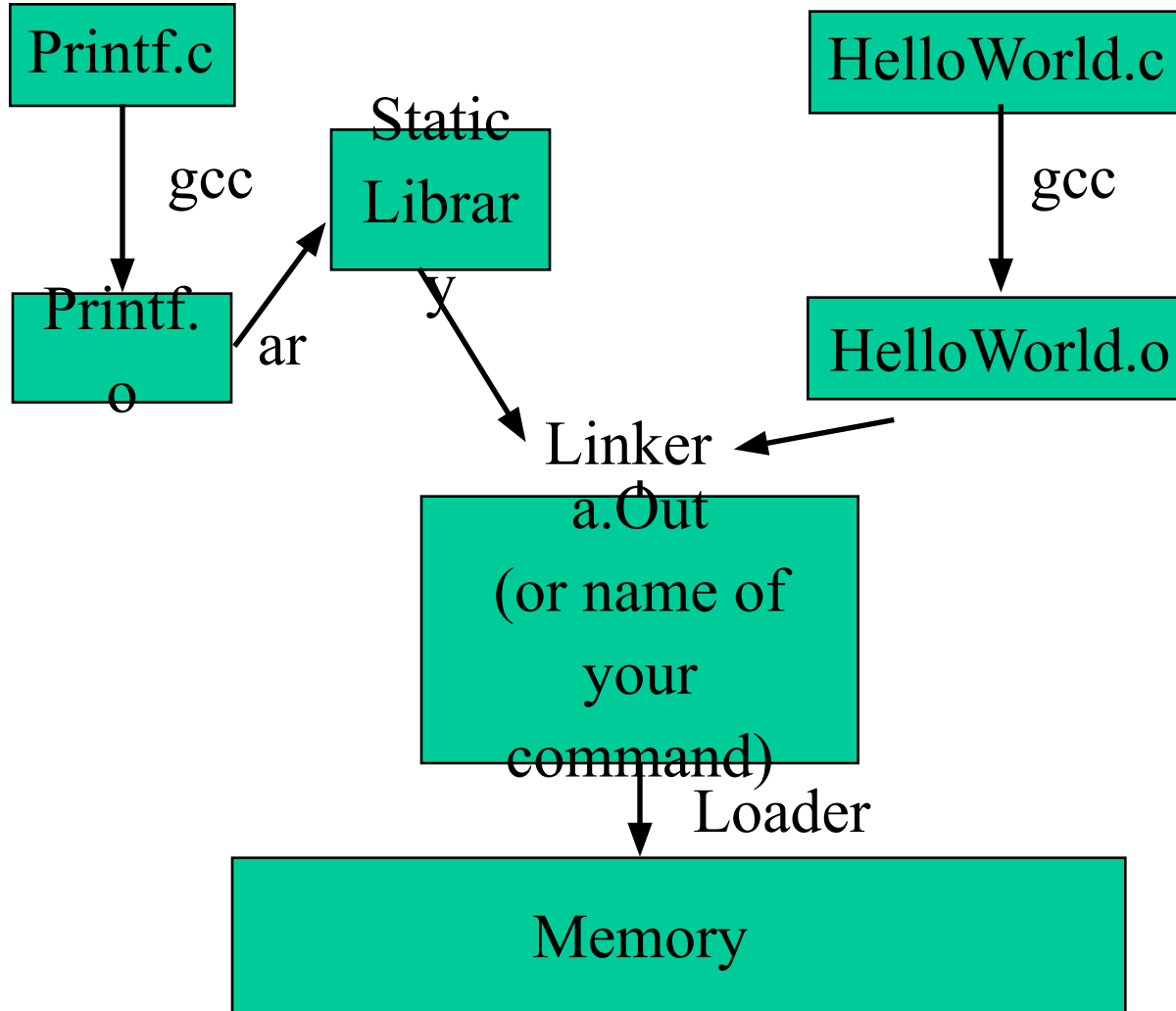

(CMU B&H ..) Run-time Linking/Loading

