

ФОТОСИНТЕЗ

Лекция для студентов 3 курса ОДО
биологического факультета

Общее уравнение фотосинтеза

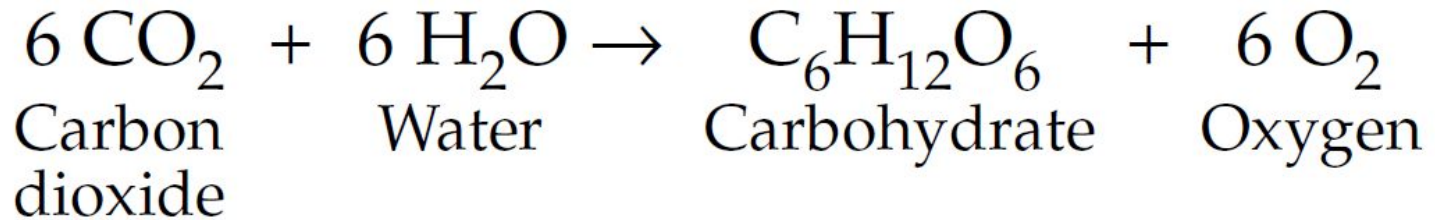

Строение хлоропласта

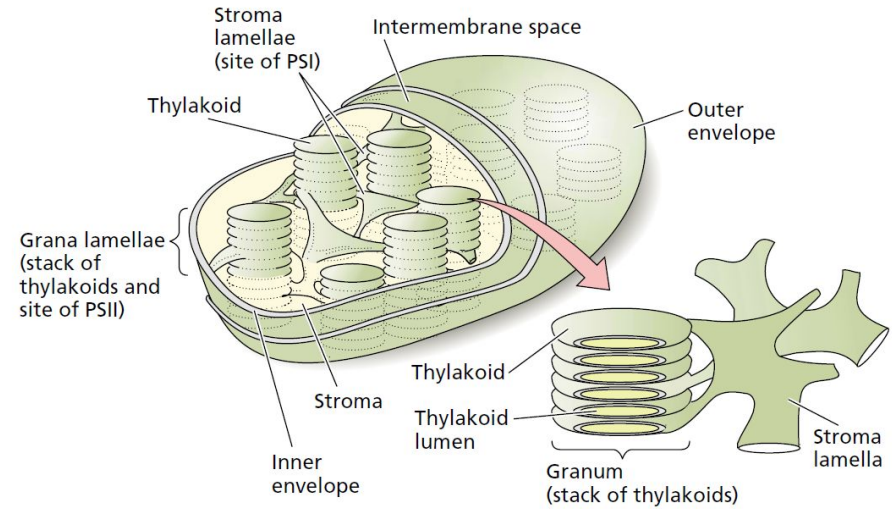
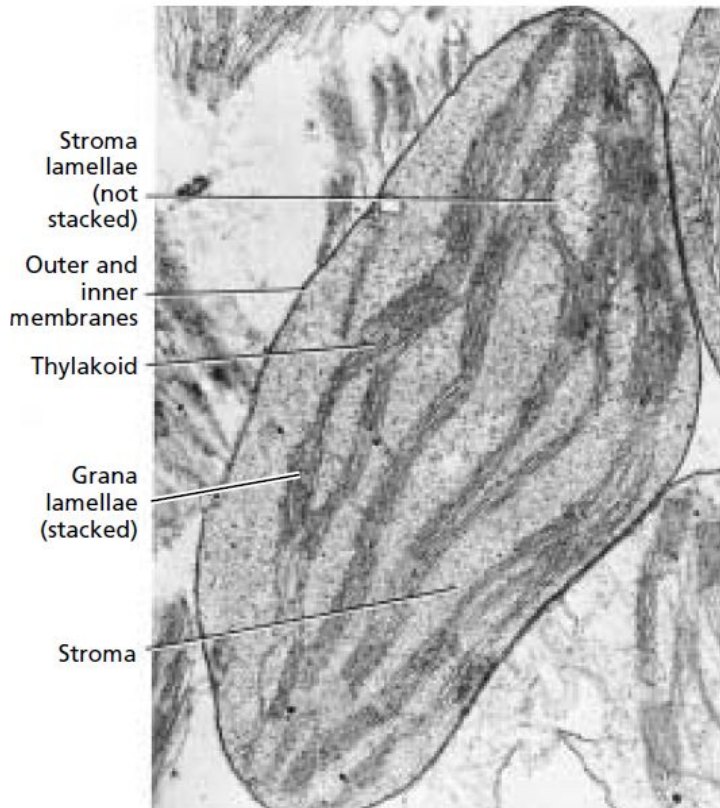

ФОТОСИНТЕЗ.

- Световые
реакции

Природа световой энергии

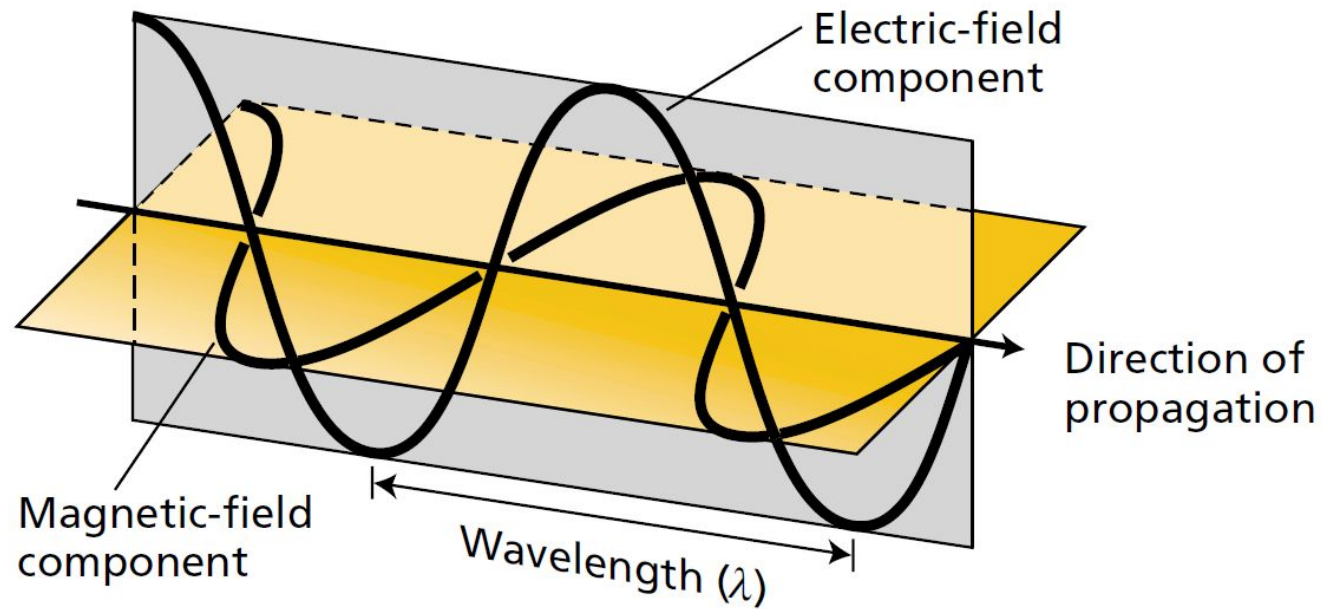

Электромагнитный спектр

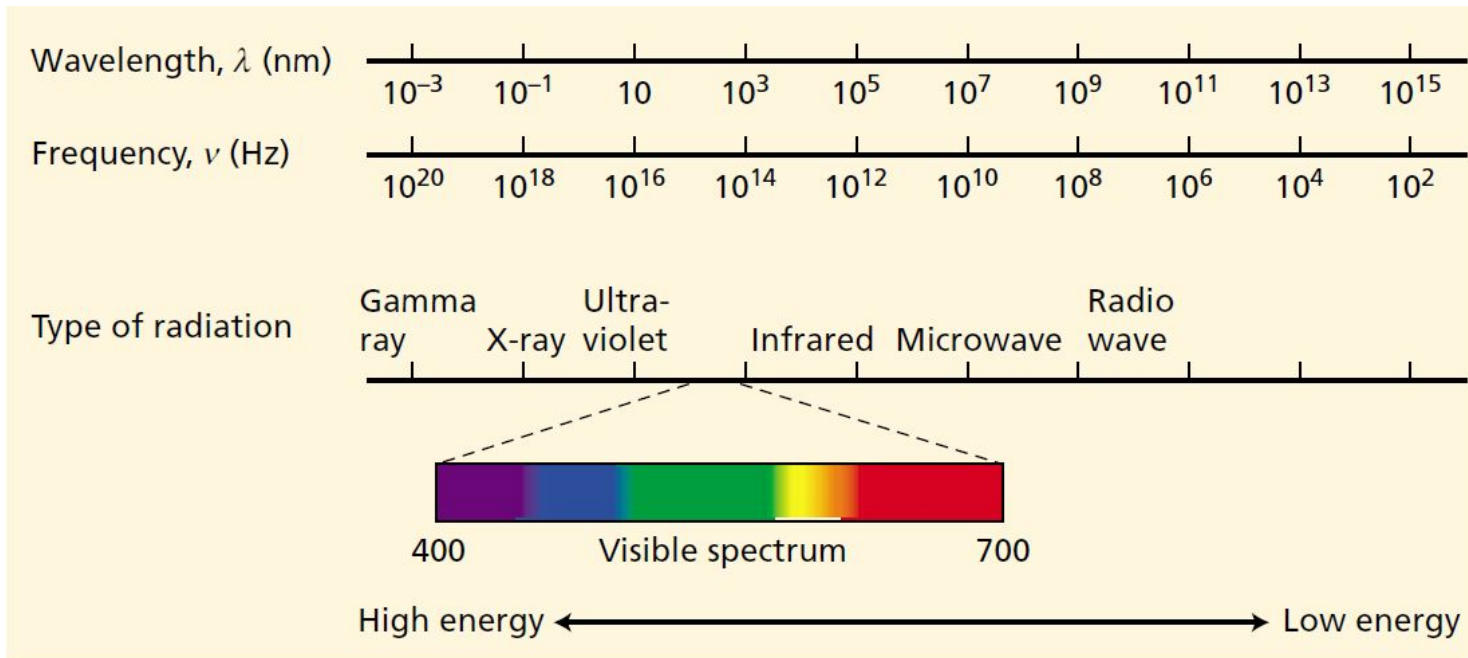

Спектр солнечного излучения и область поглощения хлорофилла

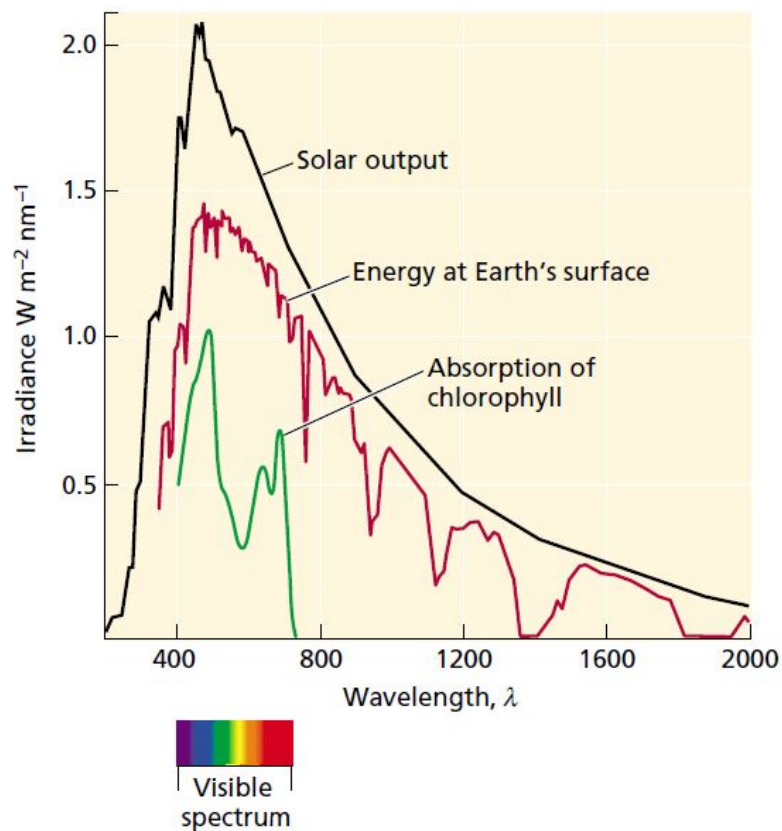

Поглощение и испускание энергии хлорофиллом

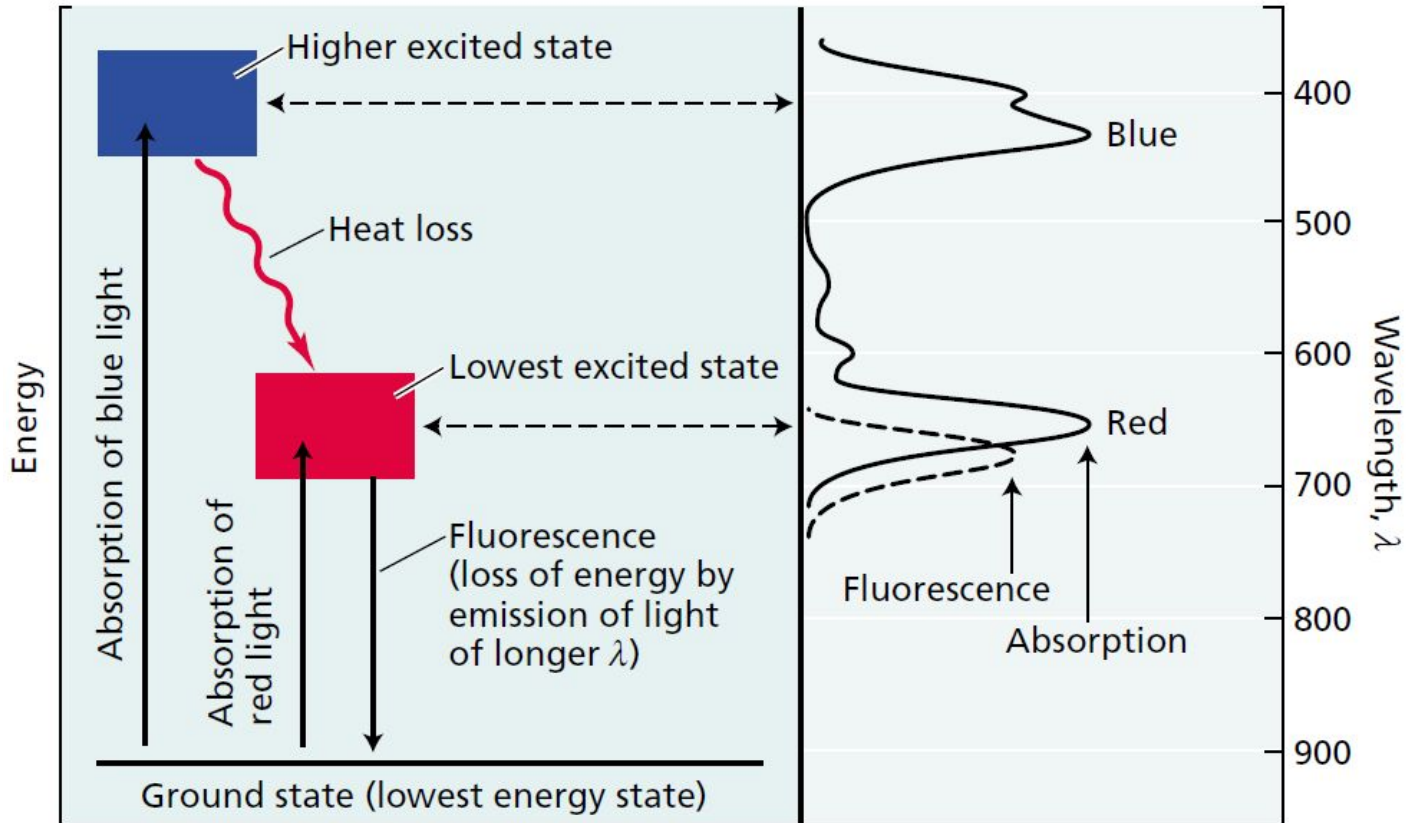

Строение фотосинтетических ПИГМЕНТОВ

(A) Chlorophylls

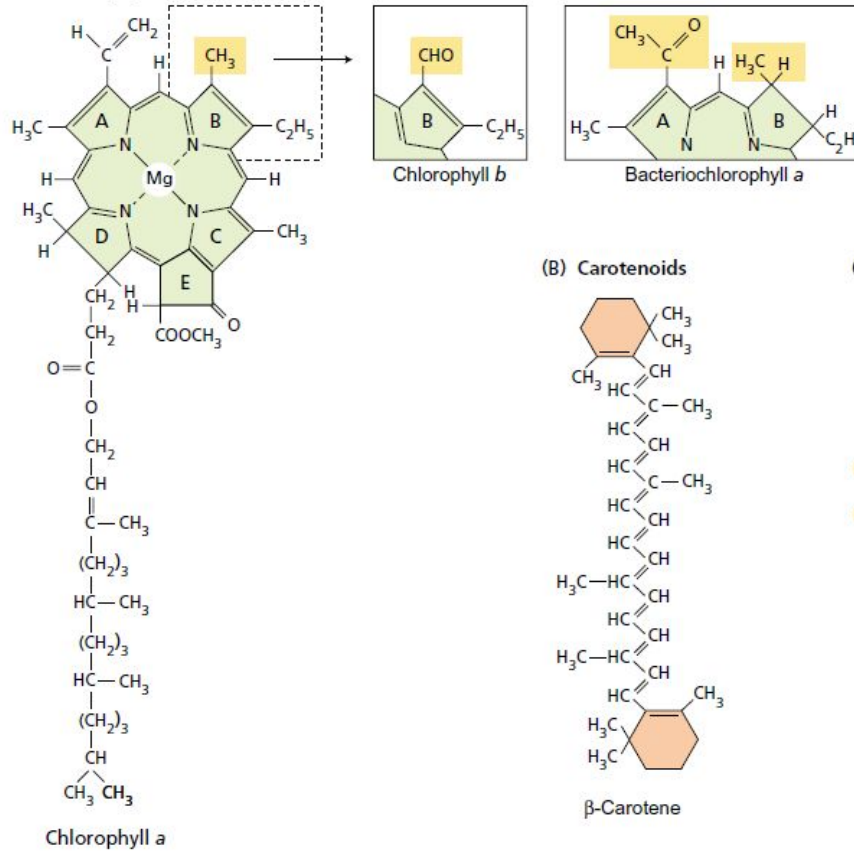

Основные этапы синтеза хлорофилла

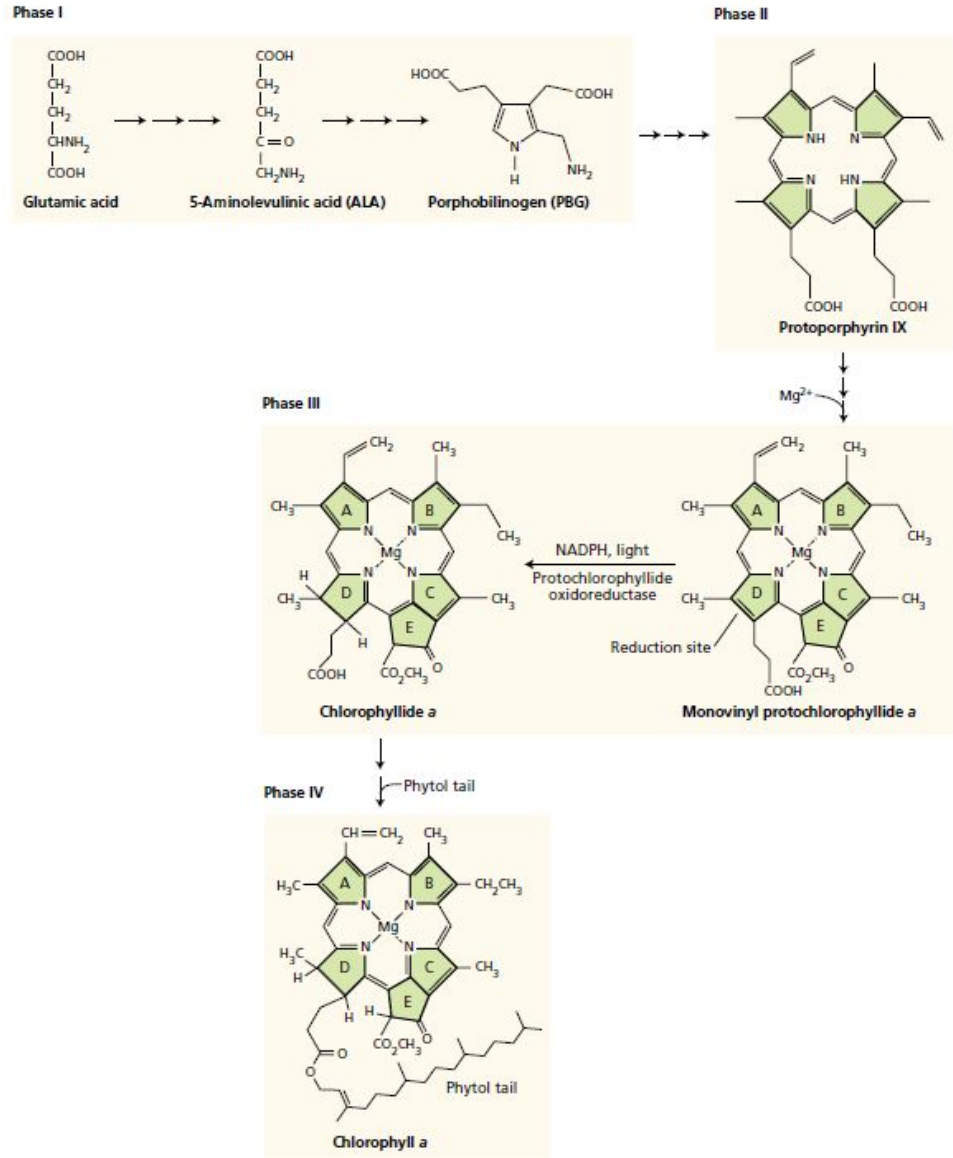

Спектры абсорбции некоторых фотосинтетических пигментов

- 1. Бактериохлорофилл а
- 2. Хлорофилл а
- 3. Хлорофилл b
- 4. Фикоэритробиллин
- 5. β -каротин



Схема эксперимента Энгельмана



Концепция трансформации энергии света в процессе фотосинтеза

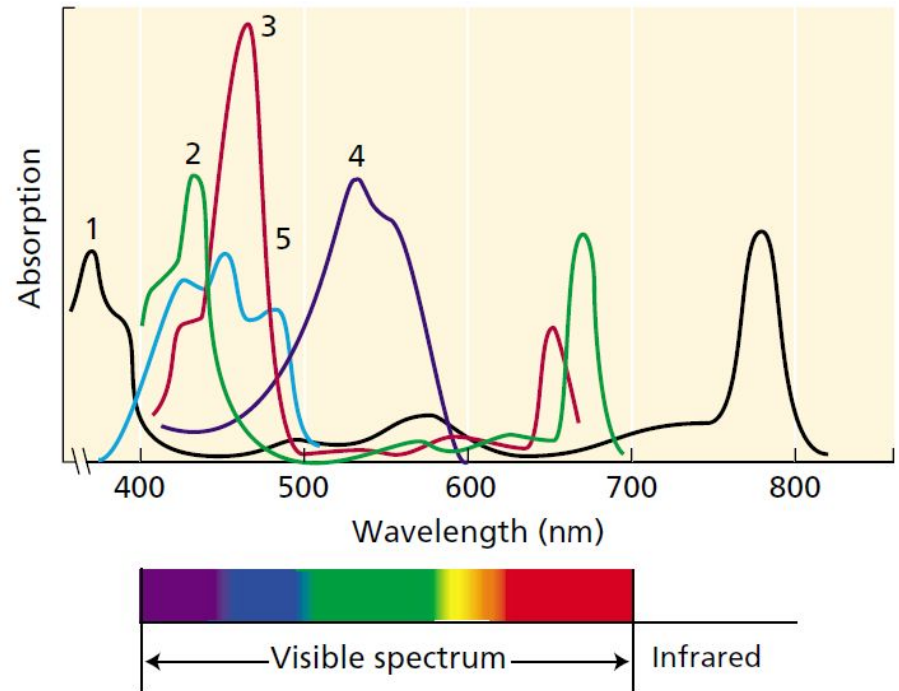
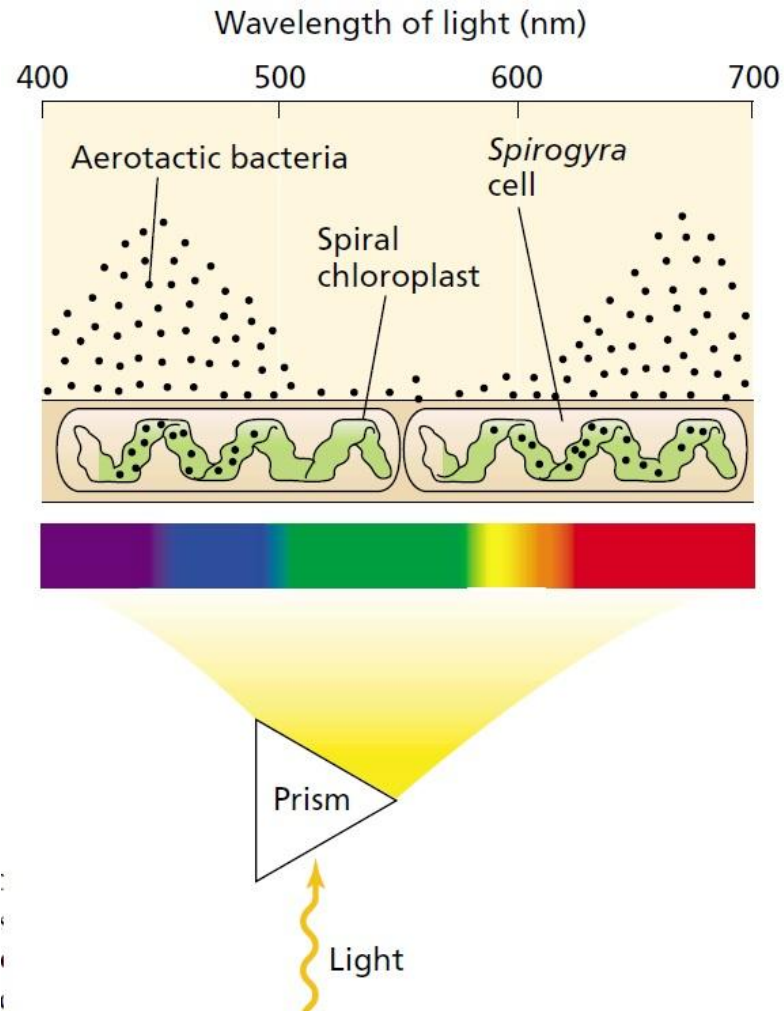
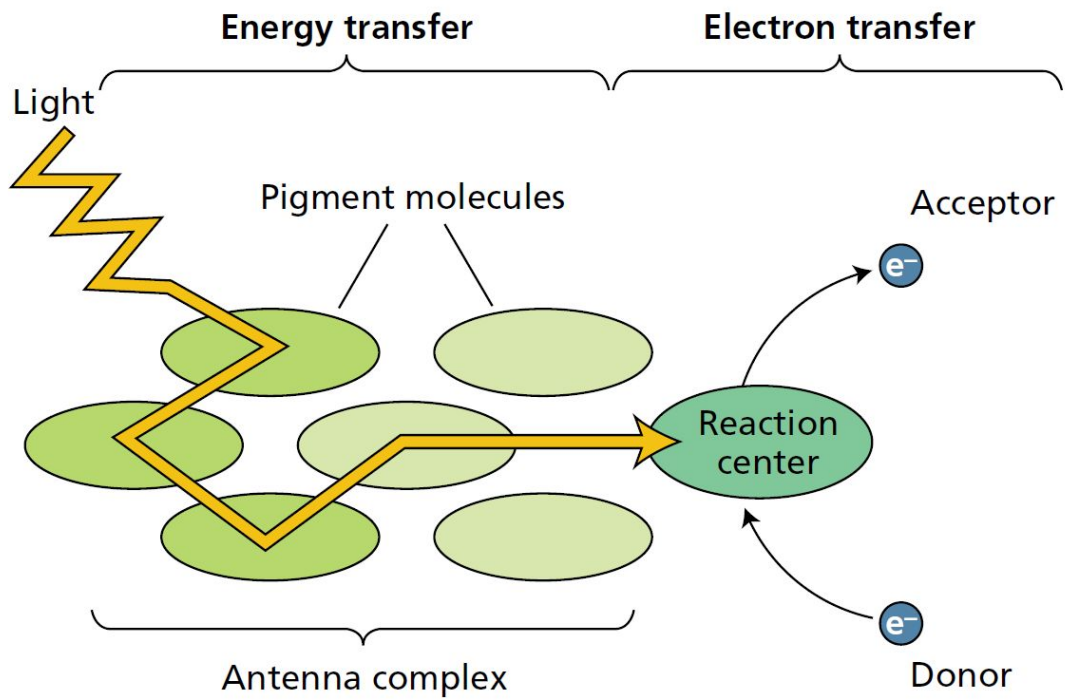

Z-схема фотосинтеза

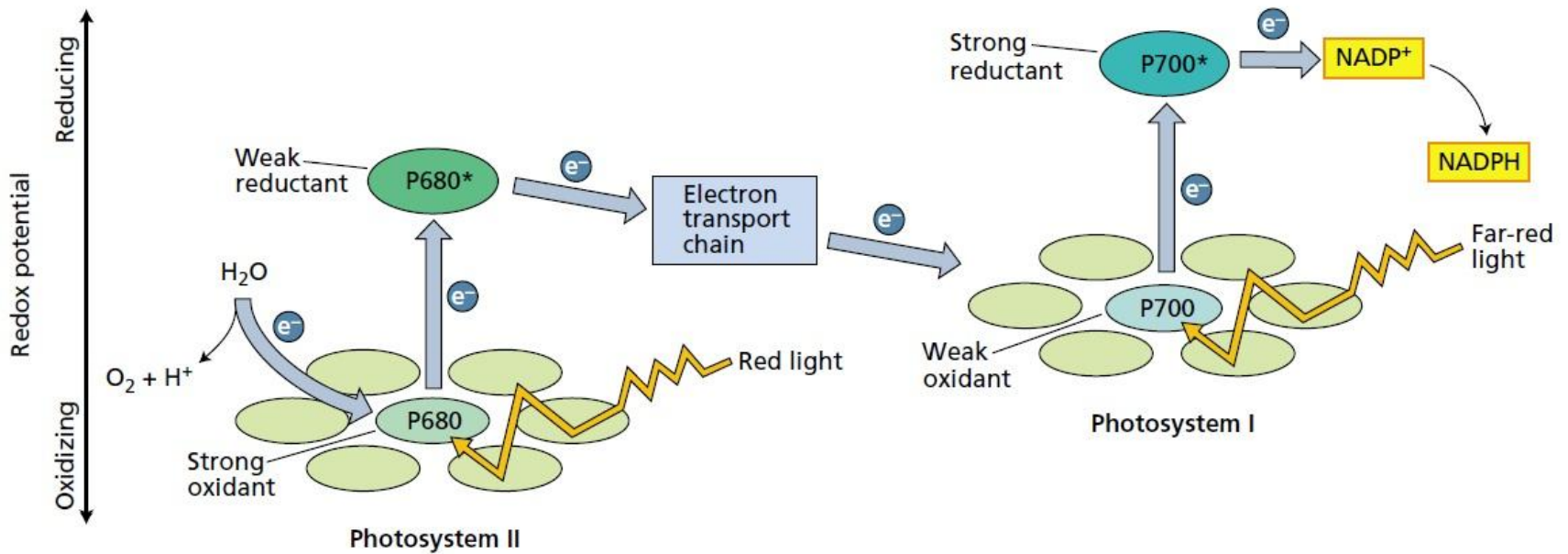



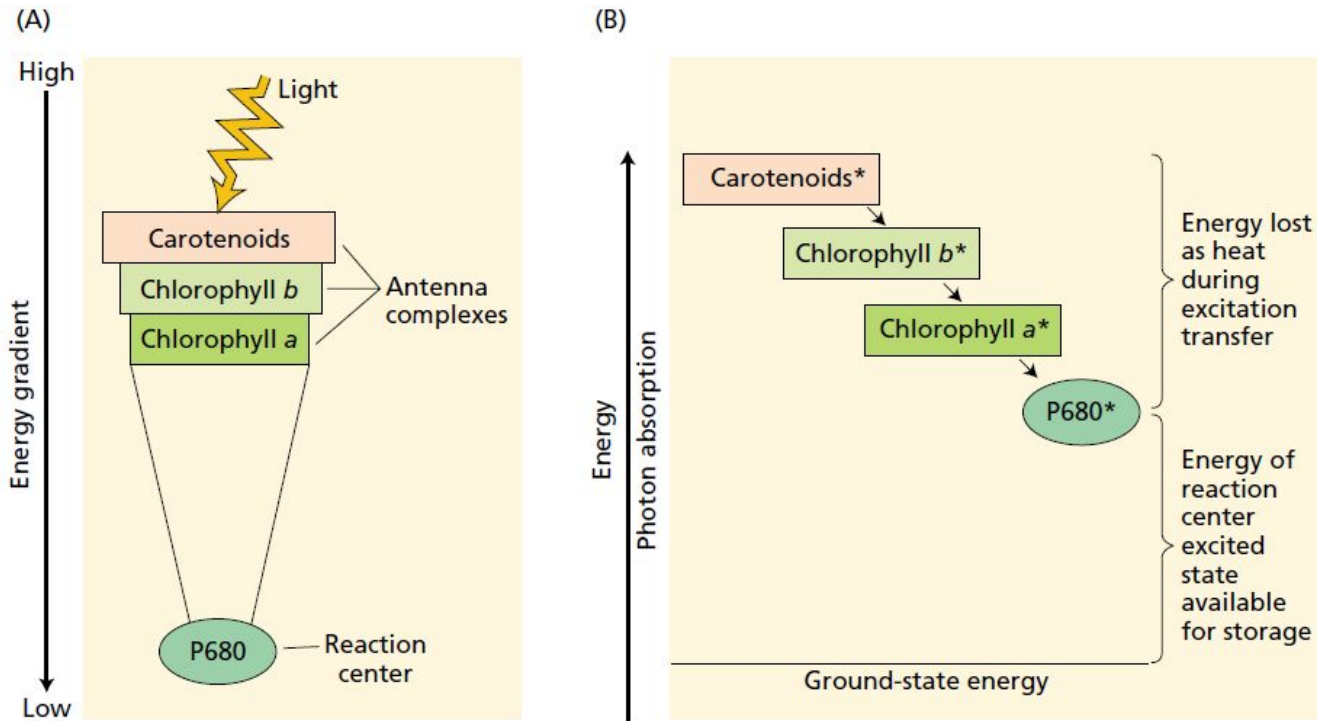

Передача энергии в светособиравющем комплексе

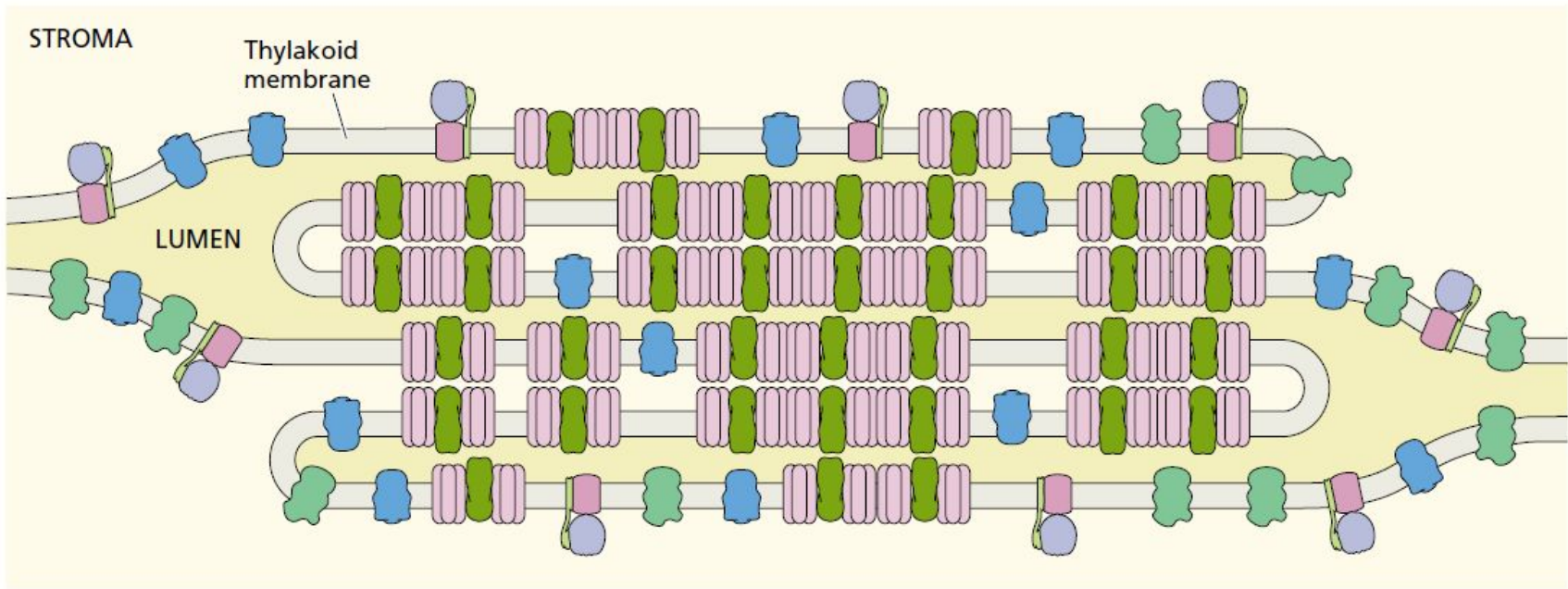

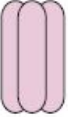
Расположение белковых комплексов в мембране тилакоидов

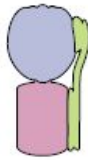

				
LHCII trimer	PSII	Cytochrome <i>b6f</i> dimer	PSI	ATP synthase

Строение светособирающего комплекса

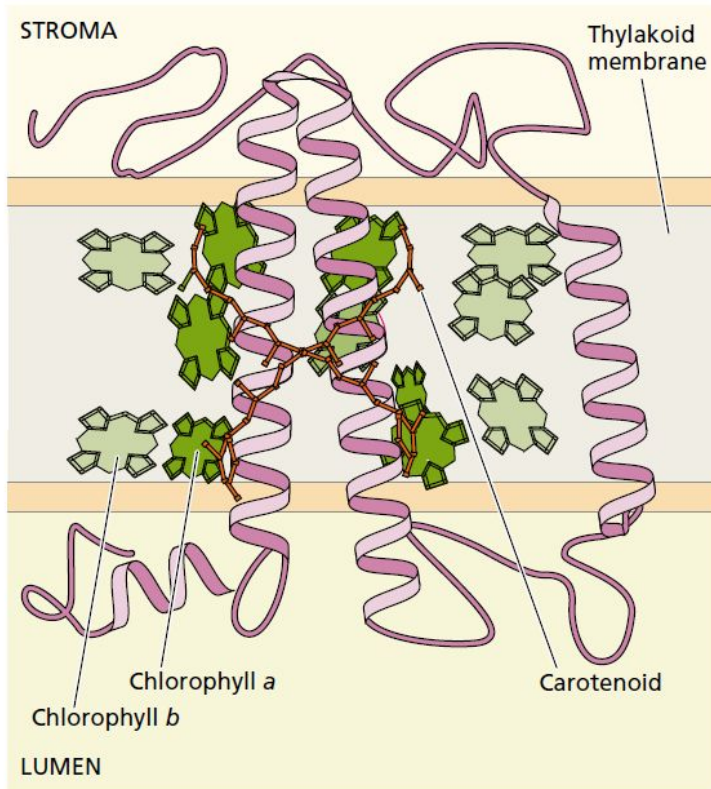

Z-схема

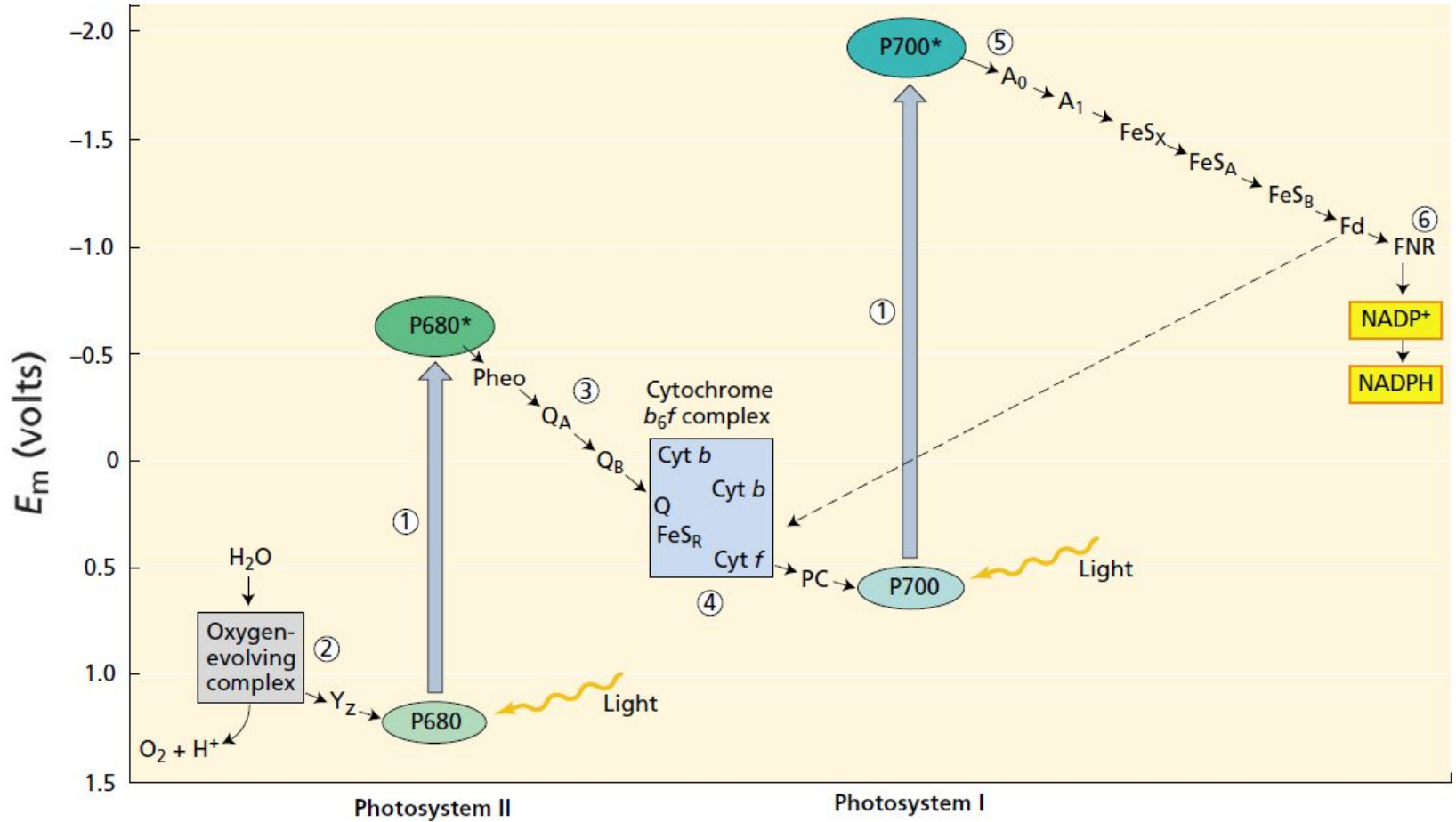

Перенос электронов и протонов по системе белковых компонентов мембраны тилакоида. Синтез АТФ

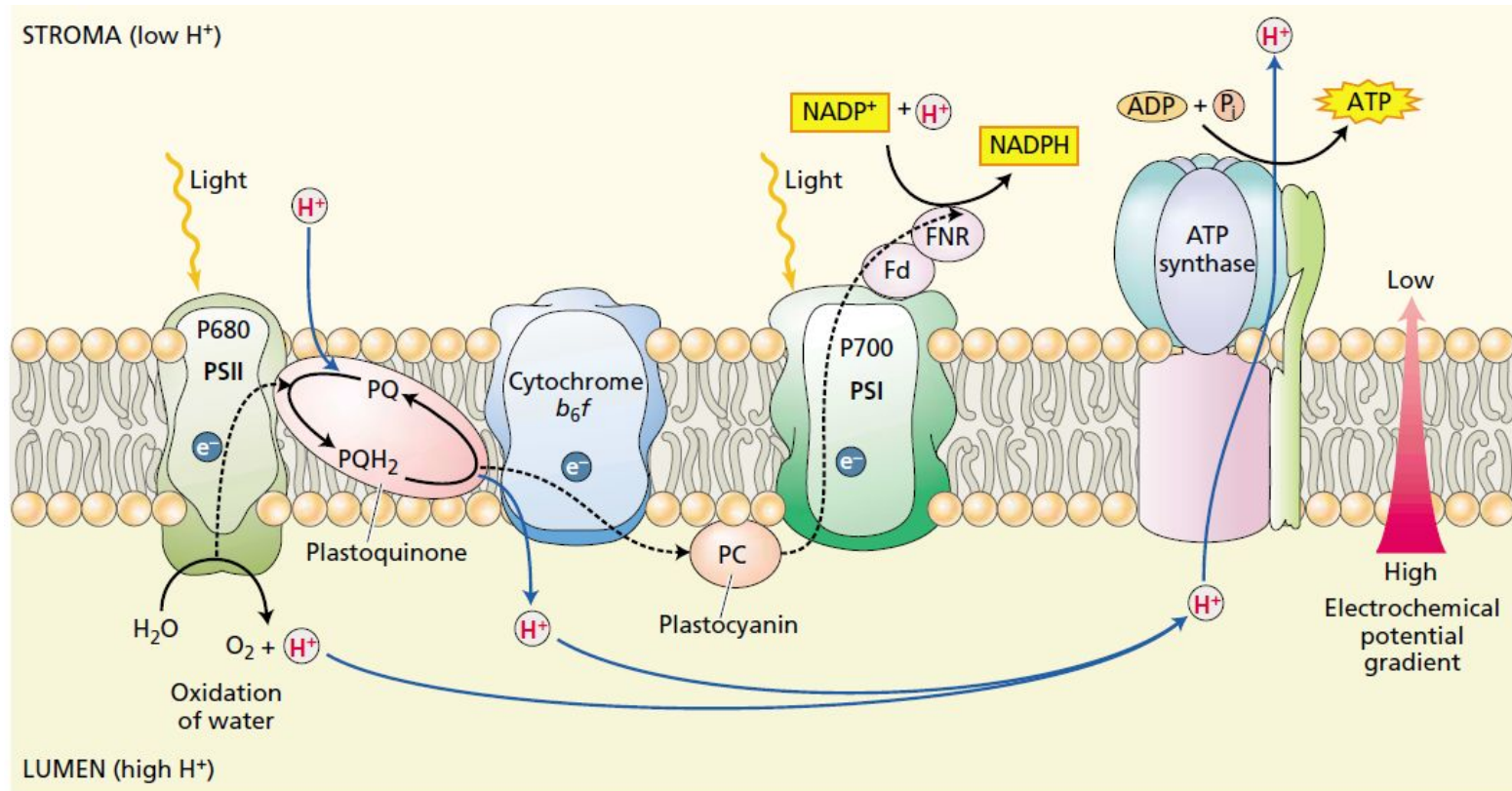

Структура ФСII и ФСI

ФСII

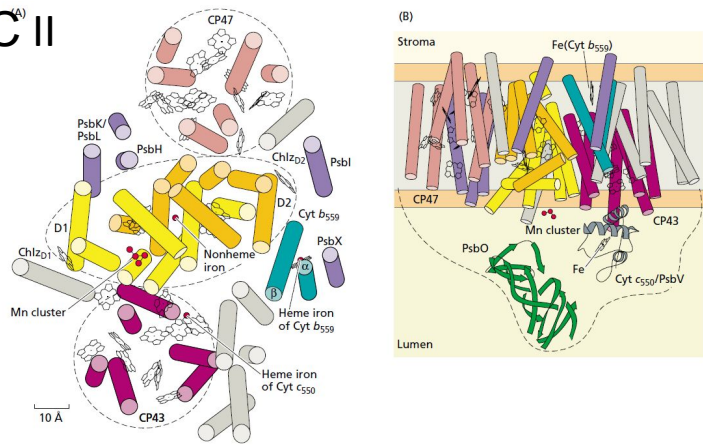

(A) First QH₂ oxidized

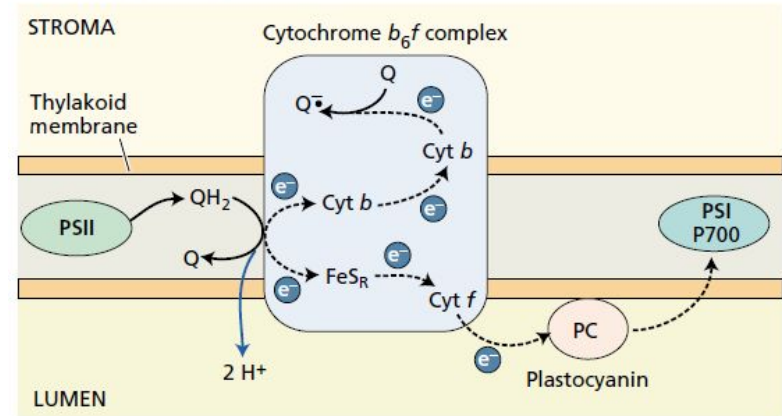

ФСI

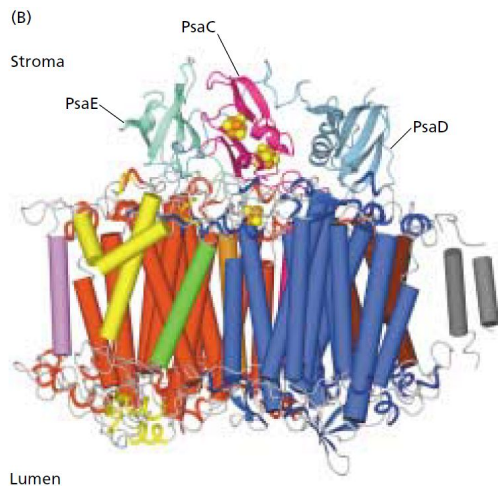

(B) Second QH₂ oxidized

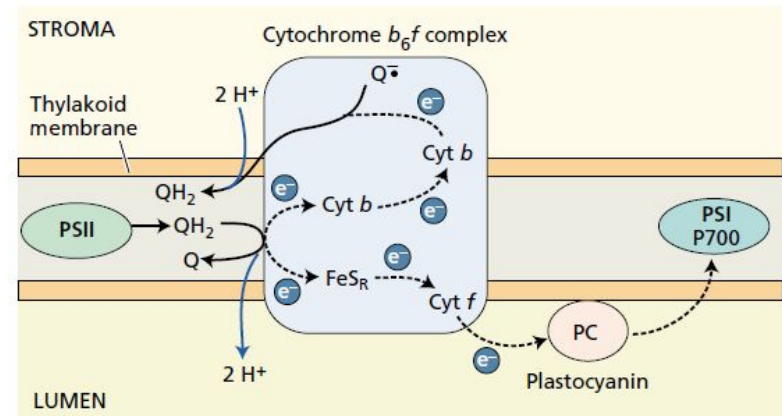

Структура АТФсинтазы

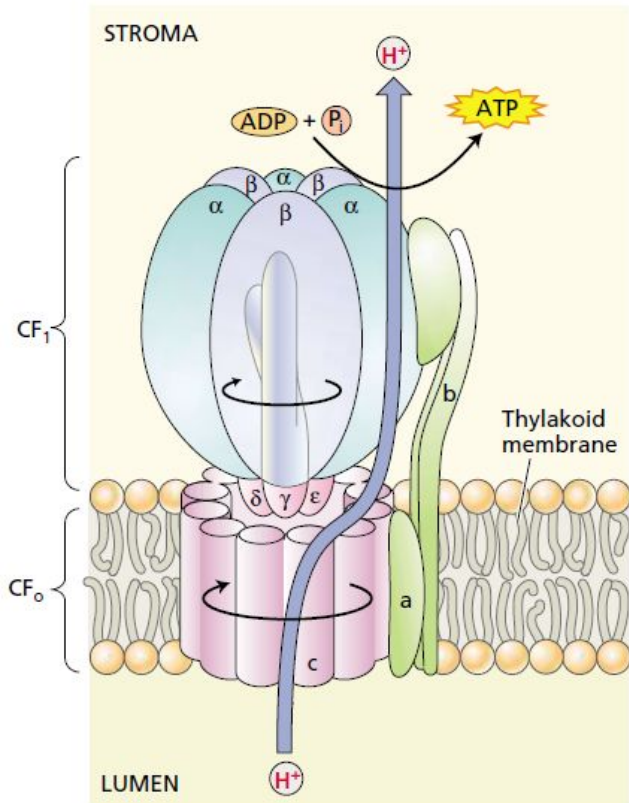

Гербициды, нарушающие транспорт электронов

(A)

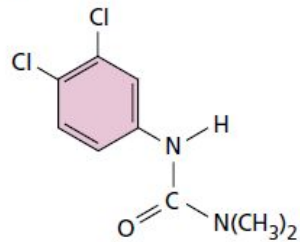

DCMU (diuron)
(dichlorophenyl-dimethylurea)

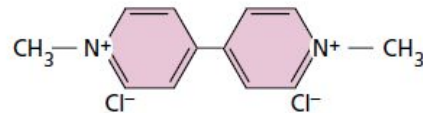

Paraquat
(methyl viologen)

(B)

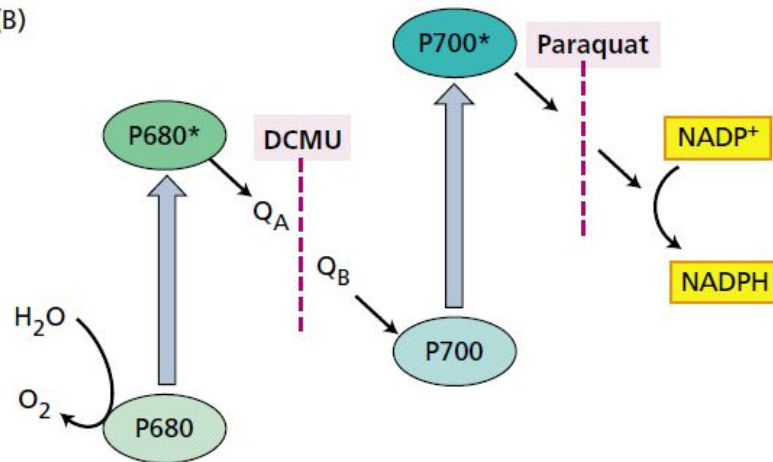

ФОТОСИНТЕЗ

- Темновые реакции

Темновая стадия фотосинтеза

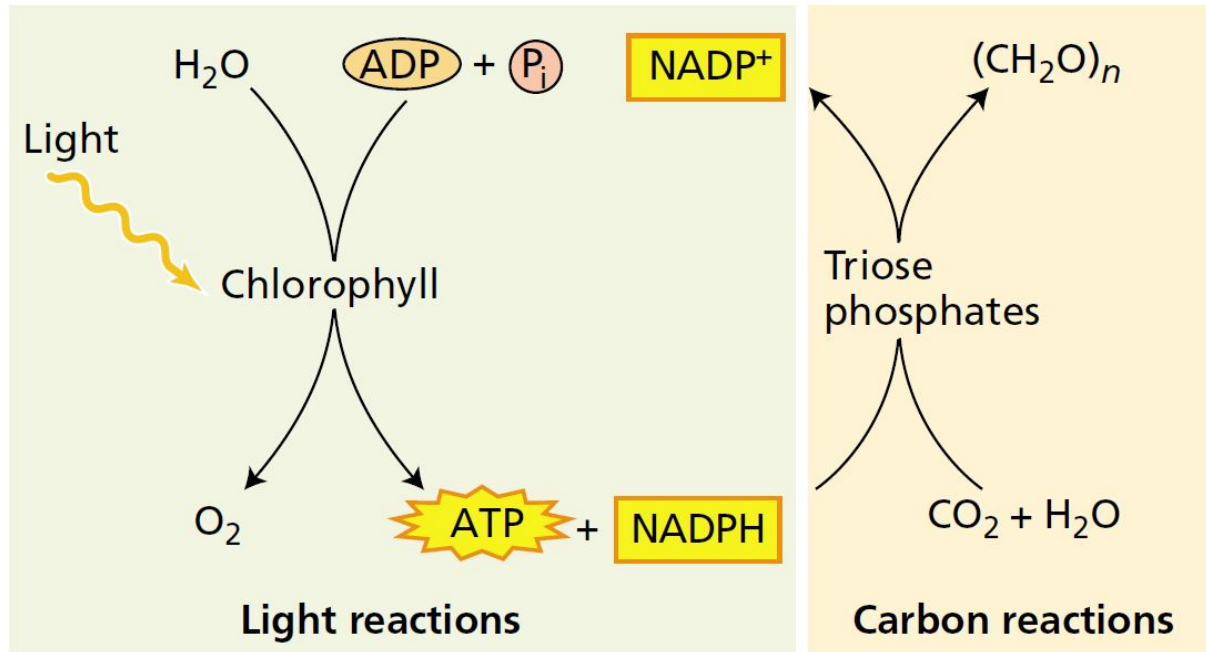

Цикл Кальвина. Основные этапы

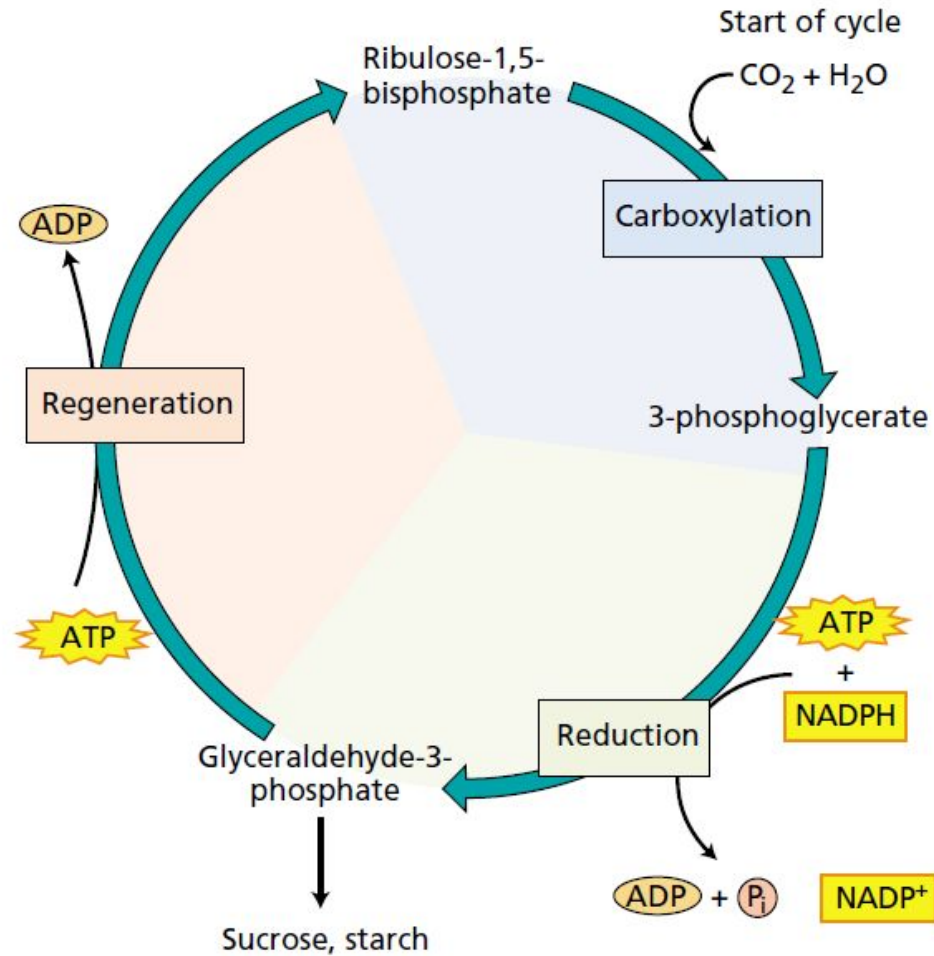

- Цикл Кальвина.
- С3-фотосинтез

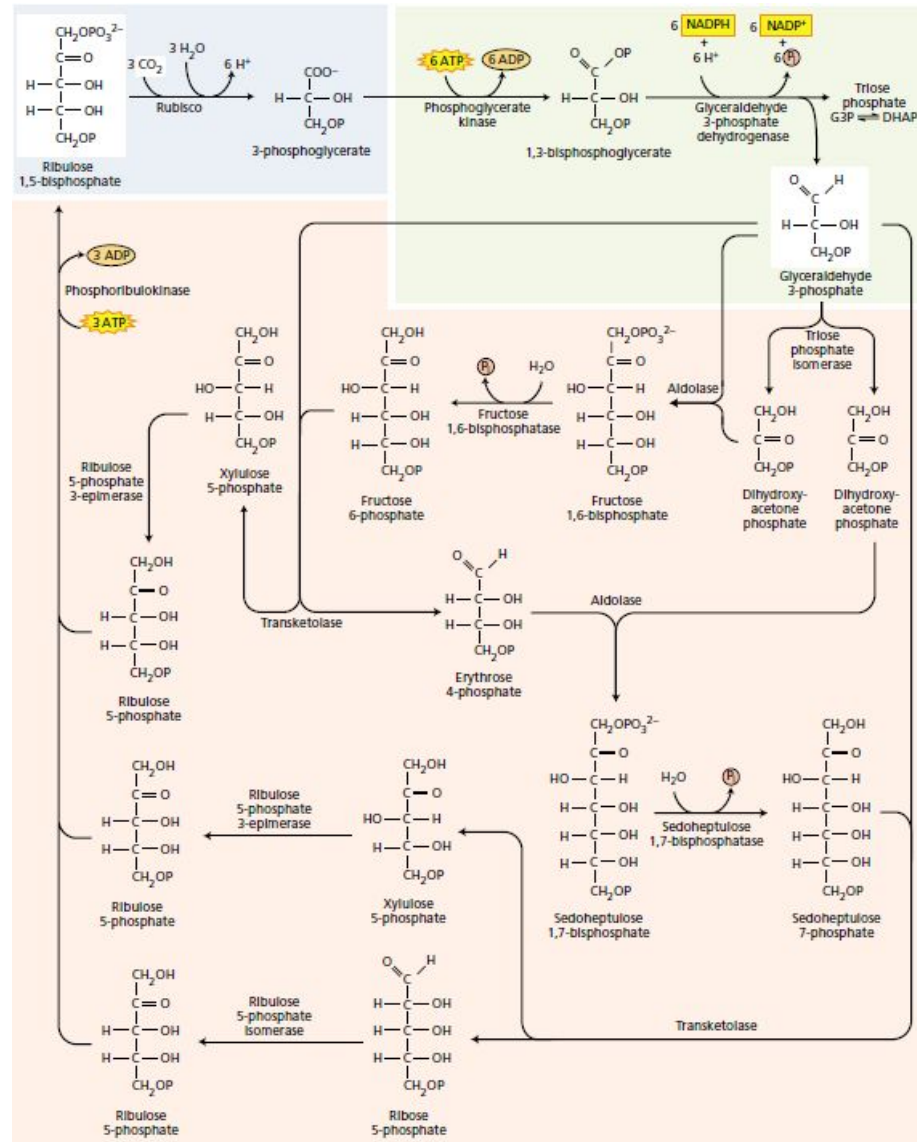

Реакции цикла Кальвина

Enzyme	Reaction
1. Ribulose-1,5-bisphosphate carboxylase/oxygenase	$6 \text{ Ribulose-1,5-bisphosphate} + 6 \text{ CO}_2 + 6 \text{ H}_2\text{O} \rightarrow 12 \text{ (3-phosphoglycerate)} + 12 \text{ H}^+$
2. 3-Phosphoglycerate kinase	$12 \text{ (3-Phosphoglycerate)} + 12 \text{ ATP} \rightarrow 12 \text{ (1,3-bisphosphoglycerate)} + 12 \text{ ADP}$
3. NADP:glyceraldehyde-3-phosphate dehydrogenase	$12 \text{ (1,3-Bisphosphoglycerate)} + 12 \text{ NADPH} + 12 \text{ H}^+ \rightarrow 12 \text{ glyceraldehyde-3-phosphate} + 12 \text{ NADP}^+ + 12 \text{ P}_i$
4. Triose phosphate isomerase	$5 \text{ Glyceraldehyde-3-phosphate} \rightarrow 5 \text{ dihydroxyacetone-3-phosphate}$
5. Aldolase	$3 \text{ Glyceraldehyde-3-phosphate} + 3 \text{ dihydroxyacetone-3-phosphate} \rightarrow 3 \text{ fructose-1,6-bisphosphate}$
6. Fructose-1,6-bisphosphatase	$3 \text{ Fructose-1,6-bisphosphate} + 3 \text{ H}_2\text{O} \rightarrow 3 \text{ fructose-6-phosphate} + 3 \text{ P}_i$
7. Transketolase	$2 \text{ Fructose-6-phosphate} + 2 \text{ glyceraldehyde-3-phosphate} \rightarrow 2 \text{ erythrose-4-phosphate} + 2 \text{ xylulose-5-phosphate}$
8. Aldolase	$2 \text{ Erythrose-4-phosphate} + 2 \text{ dihydroxyacetone-3-phosphate} \rightarrow 2 \text{ sedoheptulose-1,7-bisphosphate}$
9. Sedoheptulose-1,7,bisphosphatase	$2 \text{ Sedoheptulose-1,7-bisphosphate} + 2 \text{ H}_2\text{O} \rightarrow 2 \text{ sedoheptulose-7-phosphate} + 2 \text{ P}_i$
10. Transketolase	$2 \text{ Sedoheptulose-7-phosphate} + 2 \text{ glyceraldehyde-3-phosphate} \rightarrow 2 \text{ ribose-5-phosphate} + 2 \text{ xylulose-5-phosphate}$
11a. Ribulose-5-phosphate epimerase	$4 \text{ Xylulose-5-phosphate} \rightarrow 4 \text{ ribulose-5-phosphate}$
11b. Ribose-5-phosphate isomerase	$2 \text{ Ribose-5-phosphate} \rightarrow 2 \text{ ribulose-5-phosphate}$
12. Ribulose-5-phosphate kinase	$6 \text{ Ribulose-5-phosphate} + 6 \text{ ATP} \rightarrow 6 \text{ ribulose-1,5-bisphosphate} + 6 \text{ ADP} + 6 \text{ H}^+$
Net: $6 \text{ CO}_2 + 11 \text{ H}_2\text{O} + 12 \text{ NADPH} + 18 \text{ ATP} \rightarrow \text{Fructose-6-phosphate} + 12 \text{ NADP}^+ + 6 \text{ H}^+ + 18 \text{ ADP} + 17 \text{ P}_i$	

Карбоксилирование рибулезо-1,5-дифосфата RUBISCO

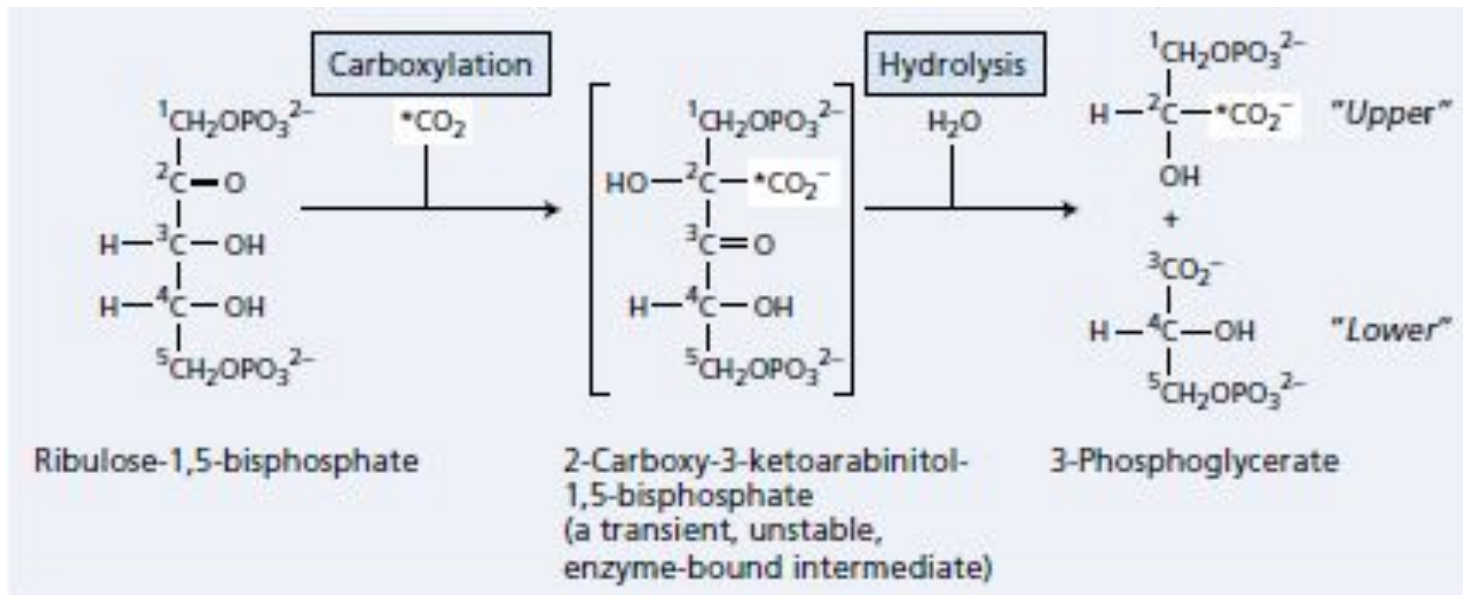

Особенности листа C4-растения

(D)

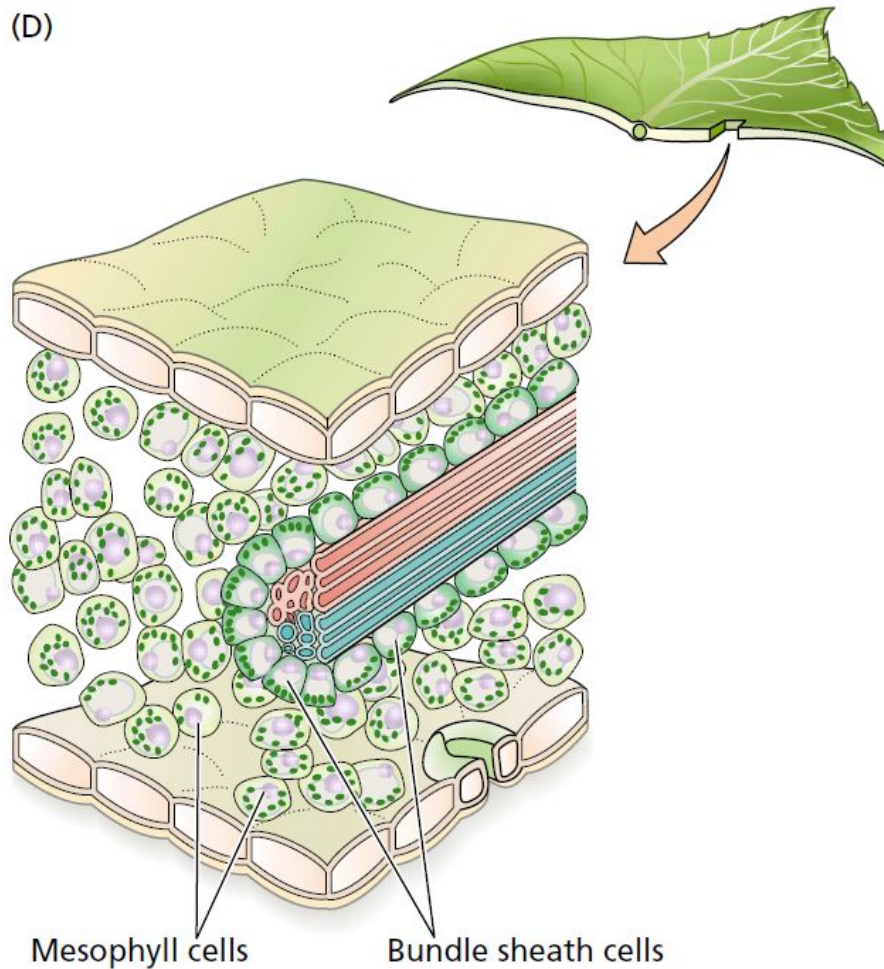

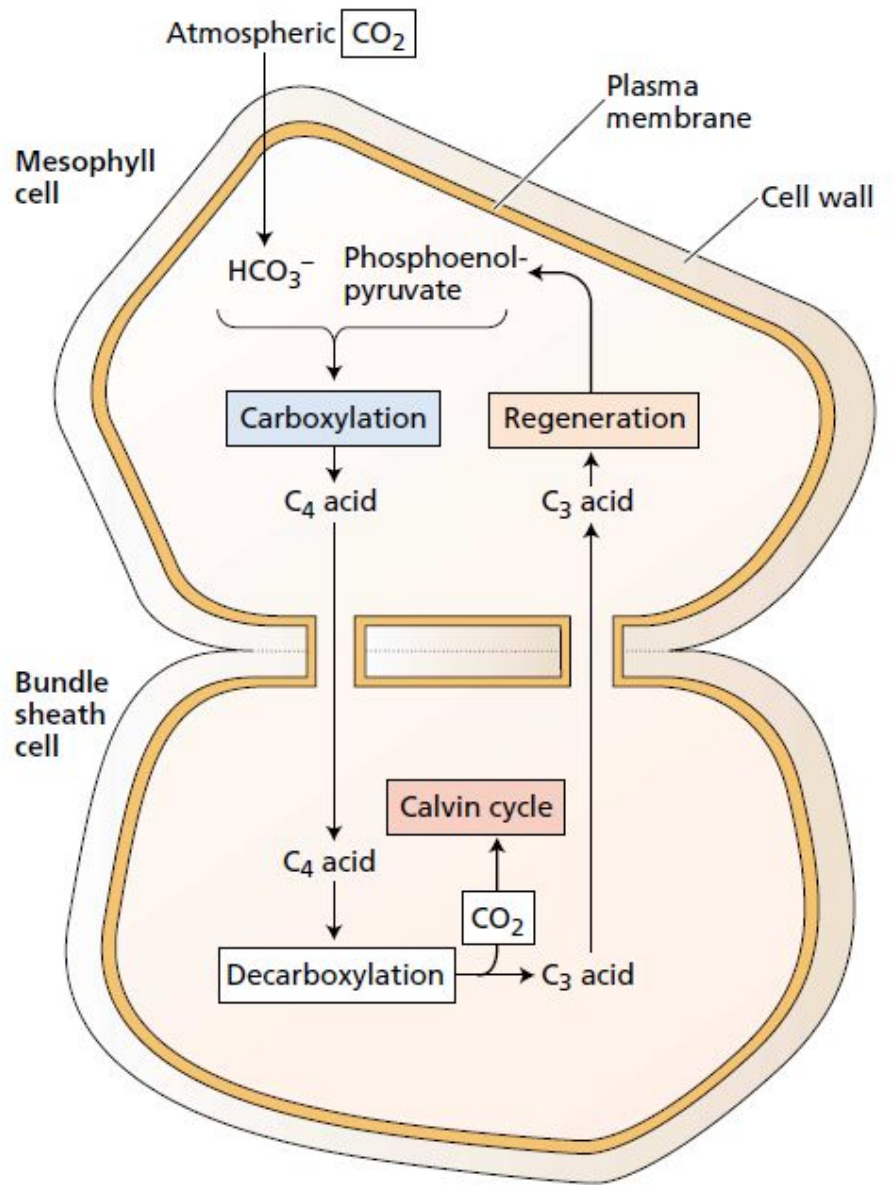

Реакции C4-пути ФС

Enzyme	Reaction
1. Phosphoenolpyruvate (PEP) carboxylase	Phosphoenolpyruvate + $\text{HCO}_3^- \rightarrow$ oxaloacetate + P_i
2. NADP:malate dehydrogenase	Oxaloacetate + NADPH + $\text{H}^+ \rightarrow$ malate + NADP^+
3. Aspartate aminotransferase	Oxaloacetate + glutamate \rightarrow aspartate + α -ketoglutarate
4. NAD(P) malic enzyme	Malate + $\text{NAD(P)}^+ \rightarrow$ pyruvate + CO_2 + NAD(P)H + H^+
5. Phosphoenolpyruvate carboxykinase	Oxaloacetate + ATP \rightarrow phosphoenolpyruvate + CO_2 + ADP
6. Alanine aminotransferase	Pyruvate + glutamate \leftrightarrow alanine + α -ketoglutarate
7. Adenylate kinase	AMP + ATP \rightarrow 2 ADP
8. Pyruvate-orthophosphate dikinase	Pyruvate + P_i + ATP \rightarrow phosphoenolpyruvate + AMP + PP_i
9. Pyrophosphatase	PP_i + $\text{H}_2\text{O} \rightarrow$ 2 P_i

C4-пусть фотосинтеза

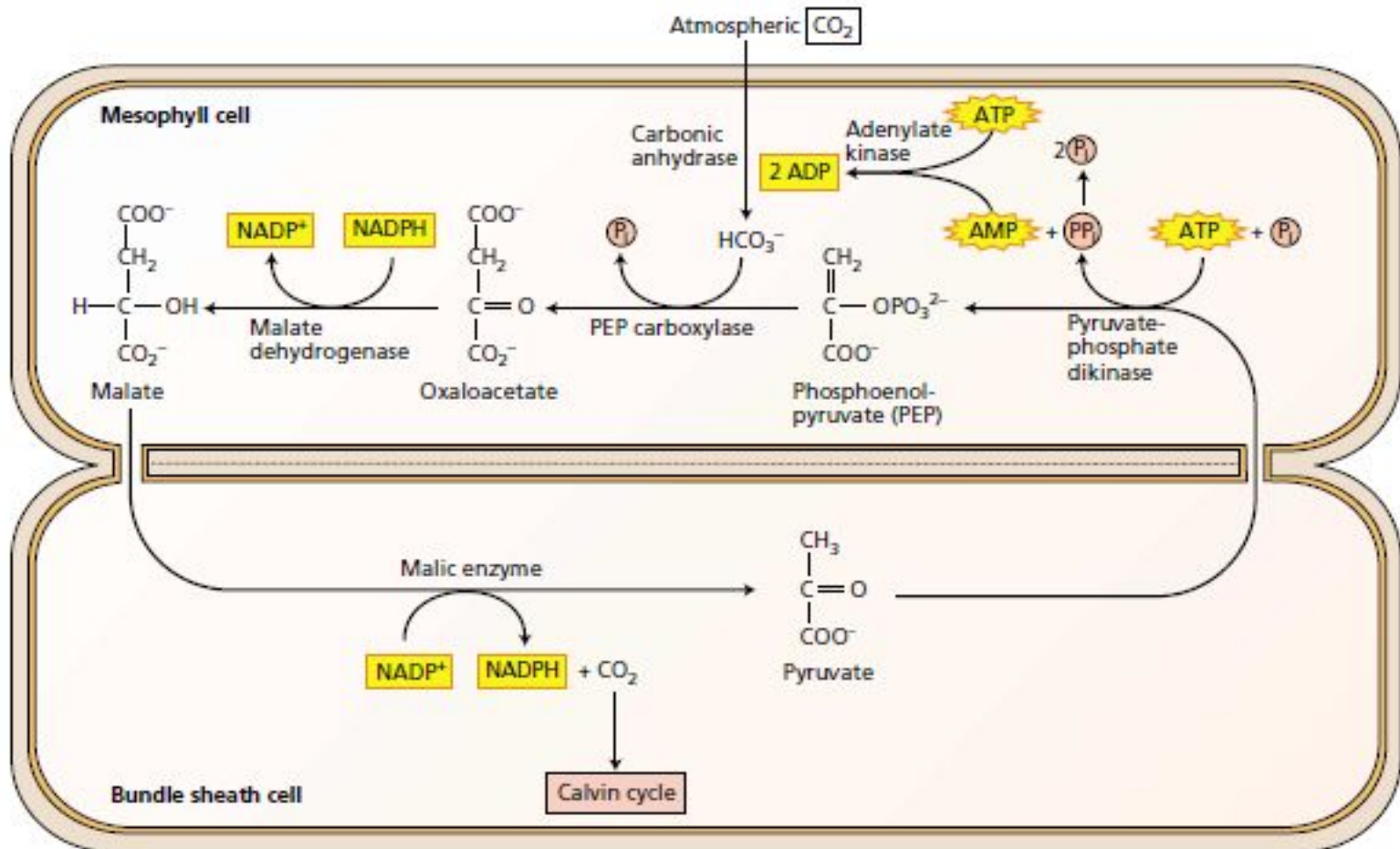

Энергетический обмен C4-пути ФС

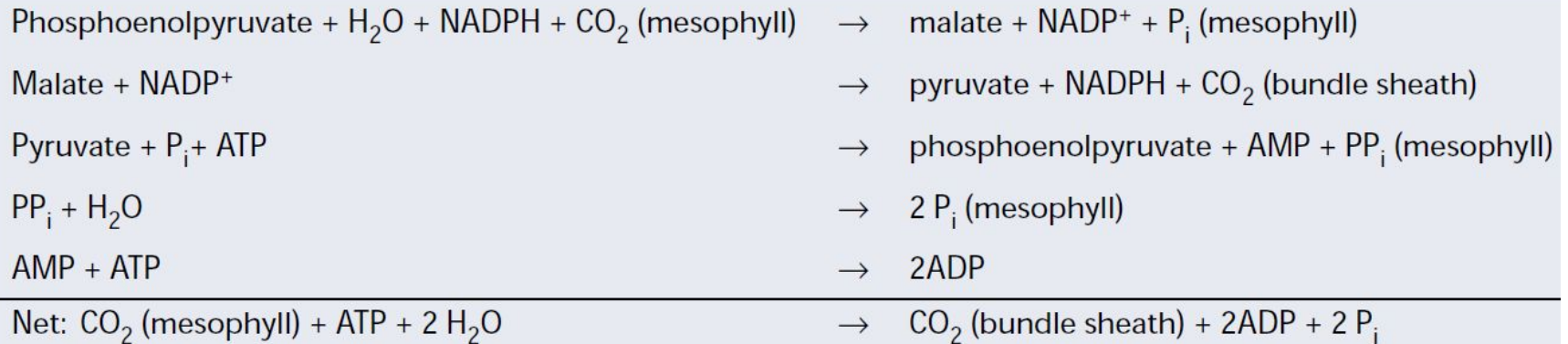

Cost of concentrating CO₂ within the bundle sheath cell = 2 ATP per CO₂

CAM-пусть ФС

Dark: Stomata opened

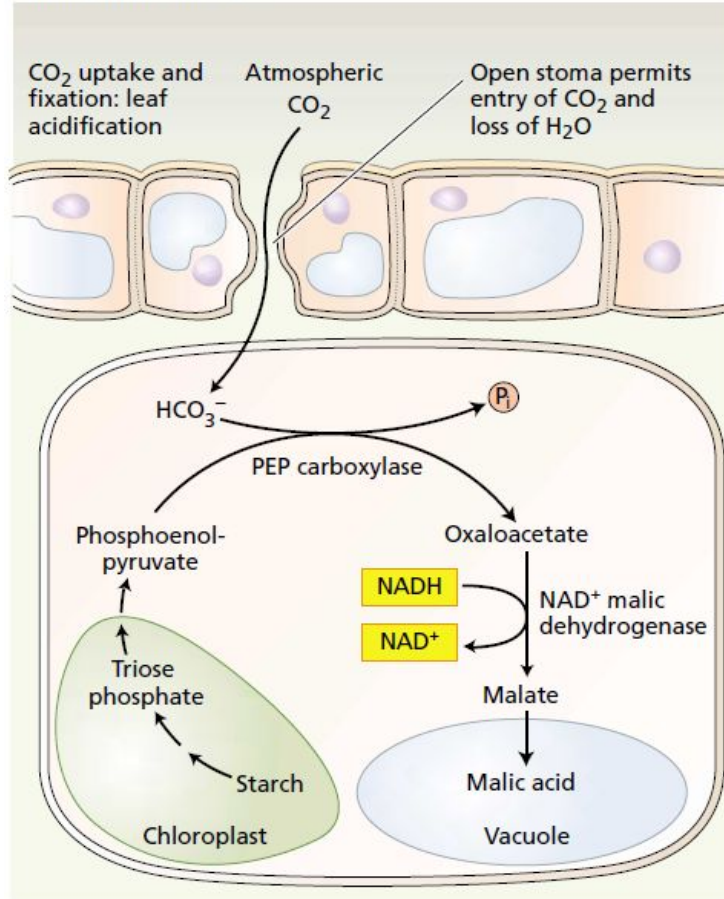

Light: Stomata closed

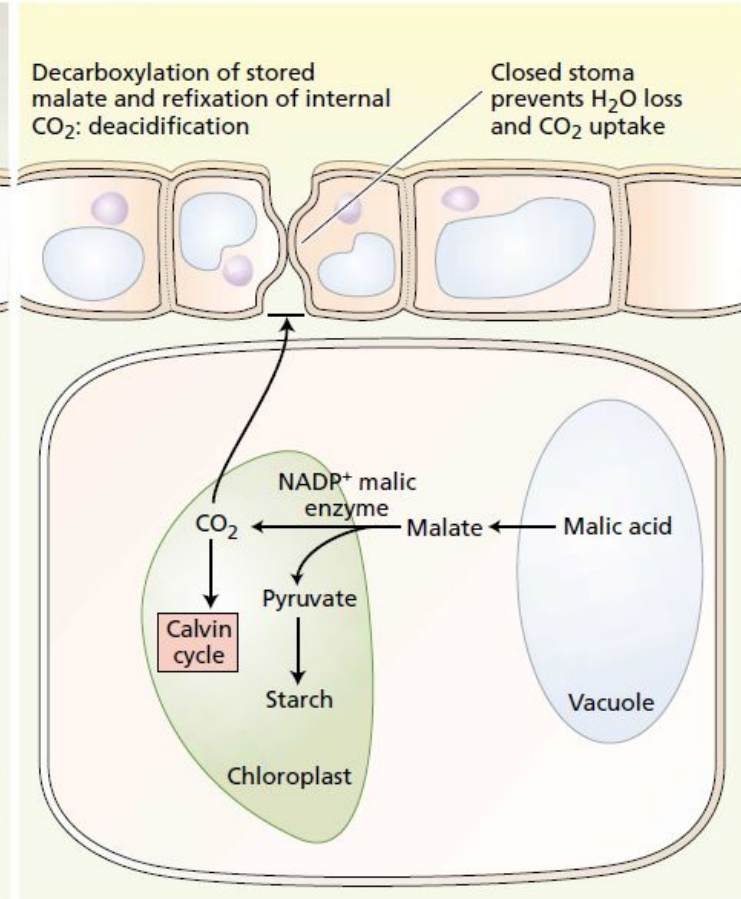

Синтез крахмала и Сахарозы

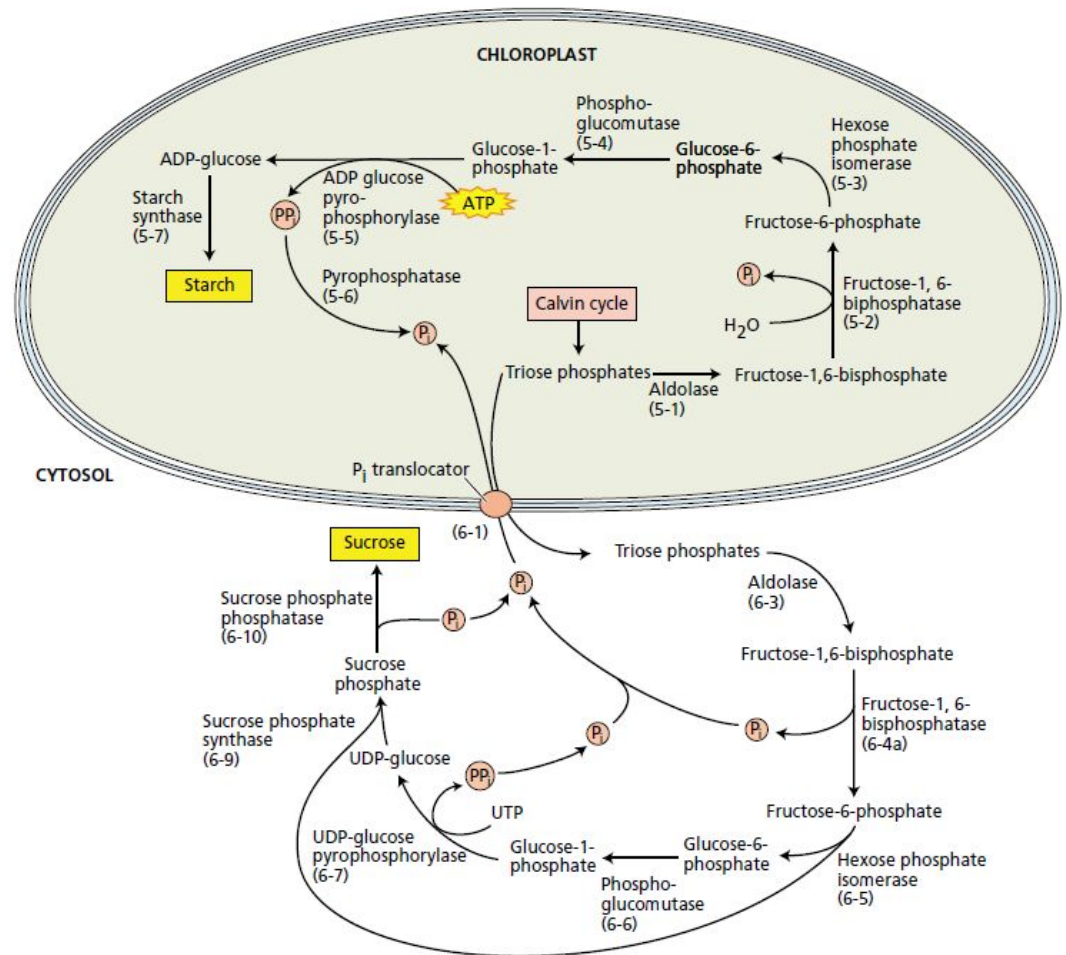

Фотодыхание

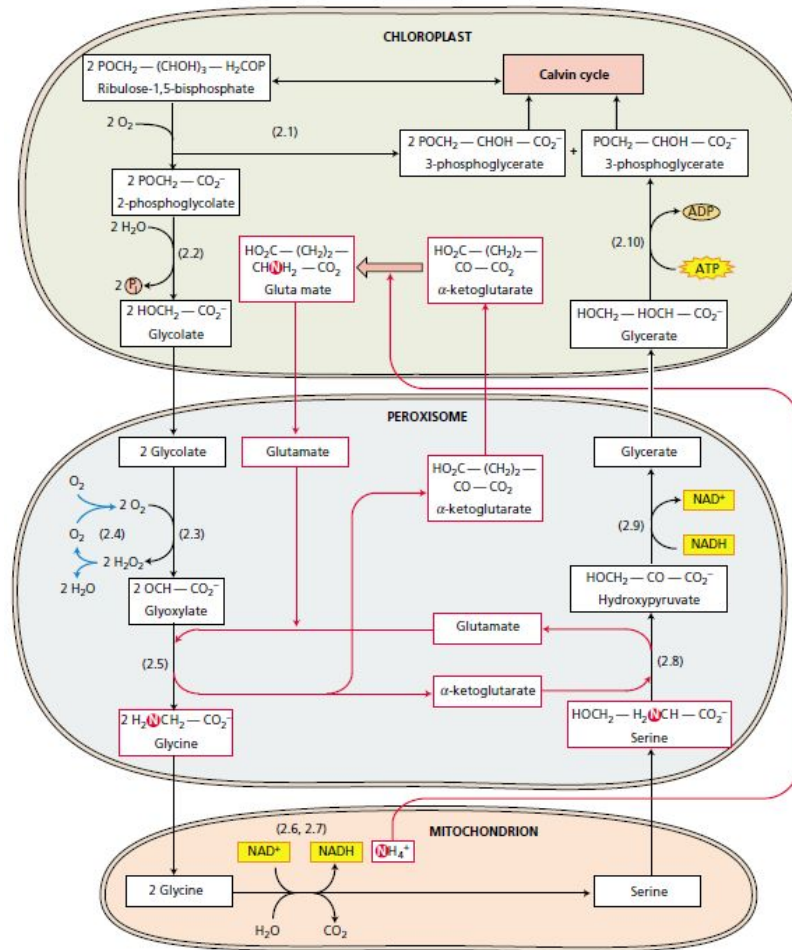

Реакции фотодыхания

Enzyme	Reaction
1. Ribulose-1,5-bisphosphate carboxylase/oxygenase (chloroplast)	$2 \text{ Ribulose-1,5-bisphosphate} + 2 \text{ O}_2 \rightarrow 2 \text{ phosphoglycolate} + 2 \text{ 3-phosphoglycerate} + 4 \text{ H}^+$
2. Phosphoglycolate phosphatase (chloroplast)	$2 \text{ Phosphoglycolate} + 2 \text{ H}_2\text{O} \rightarrow 2 \text{ glycolate} + 2 \text{ P}_i$
3. Glycolate oxidase (peroxisome)	$2 \text{ Glycolate} + 2 \text{ O}_2 \rightarrow 2 \text{ glyoxylate} + 2 \text{ H}_2\text{O}_2$
4. Catalase (peroxisome)	$2 \text{ H}_2\text{O}_2 \rightarrow 2 \text{ H}_2\text{O} + \text{ O}_2$
5. Glyoxylate:glutamate aminotransferase (peroxisome)	$2 \text{ Glyoxylate} + 2 \text{ glutamate} \rightarrow 2 \text{ glycine} + 2 \alpha\text{-ketoglutarate}$
6. Glycine decarboxylase (mitochondrion)	$\text{Glycine} + \text{ NAD}^+ + \text{ H}^+ + \text{ H}_4\text{-folate} \rightarrow \text{ NADH} + \text{ CO}_2 + \text{ NH}_4^+ + \text{ methylene-H}_4\text{-folate}$
7. Serine hydroxymethyltransferase (mitochondrion)	$\text{Methylene-H}_4\text{-folate} + \text{ H}_2\text{O} + \text{ glycine} \rightarrow \text{ serine} + \text{ H}_4\text{-folate}$
8. Serine aminotransferase (peroxisome)	$\text{Serine} + \alpha\text{-ketoglutarate} \rightarrow \text{ hydroxypyruvate} + \text{ glutamate}$
9. Hydroxypyruvate reductase (peroxisome)	$\text{Hydroxypyruvate} + \text{ NADH} + \text{ H}^+ \rightarrow \text{ glycerate} + \text{ NAD}^+$
10. Glycerate kinase (chloroplast)	$\text{Glycerate} + \text{ ATP} \rightarrow \text{ 3-phosphoglycerate} + \text{ ADP} + \text{ H}^+$

