

Sensors



Sensors

Sensors

Angular sensor – Resolver sensor

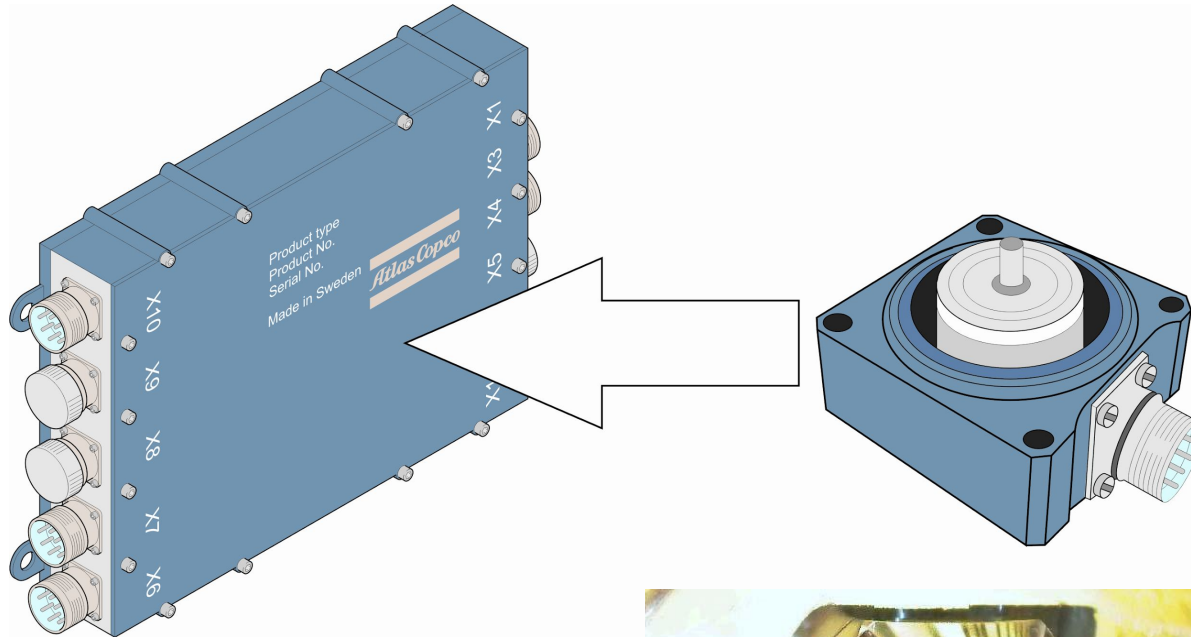

Sensors

Length sensor - Baluff

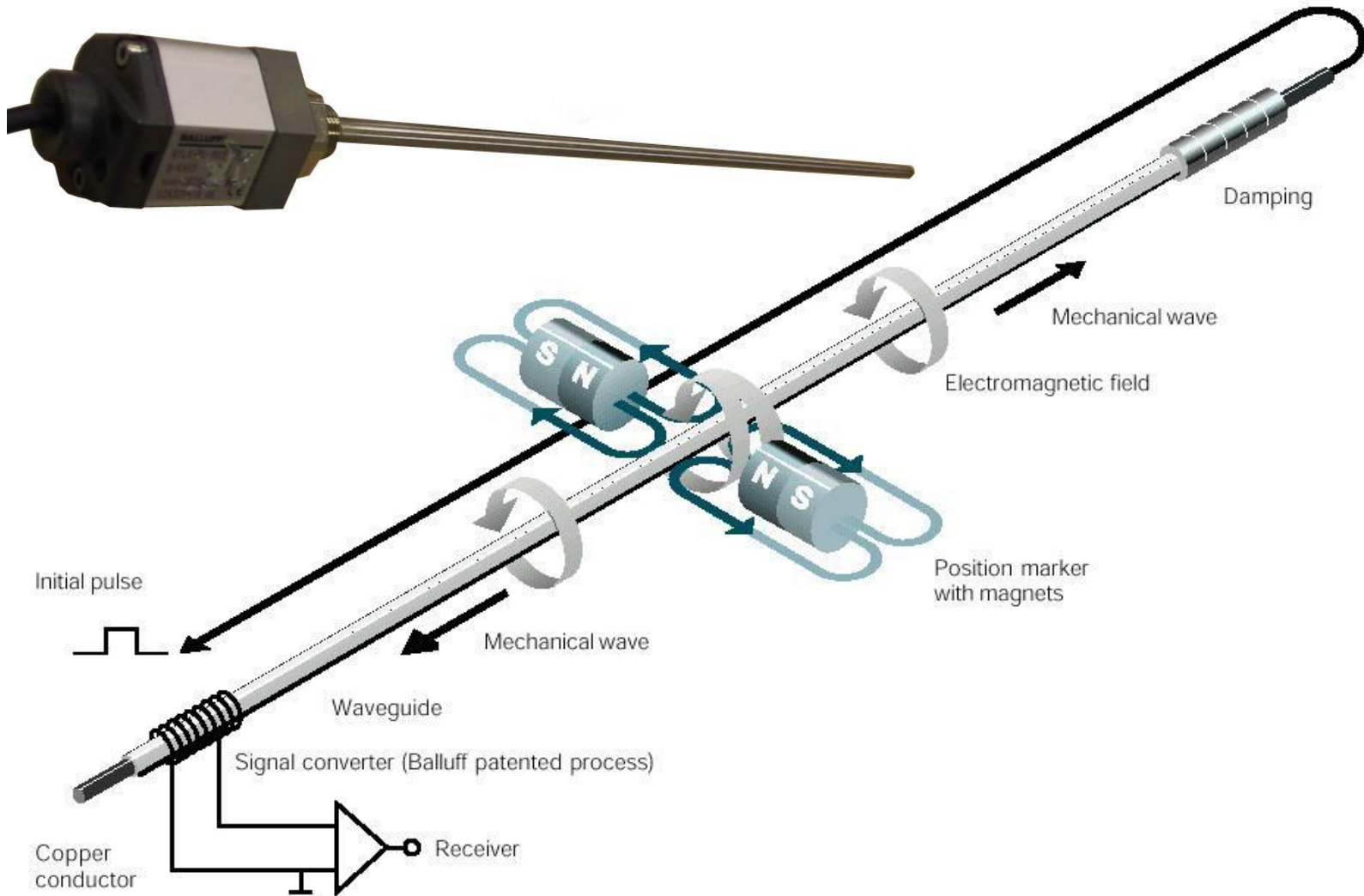

Sensors

Position sensor – Inductive sensor

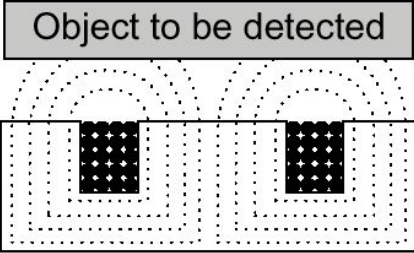
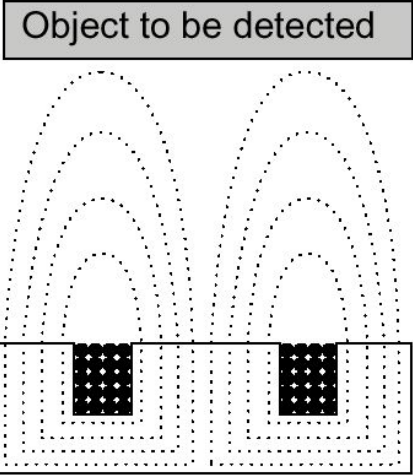
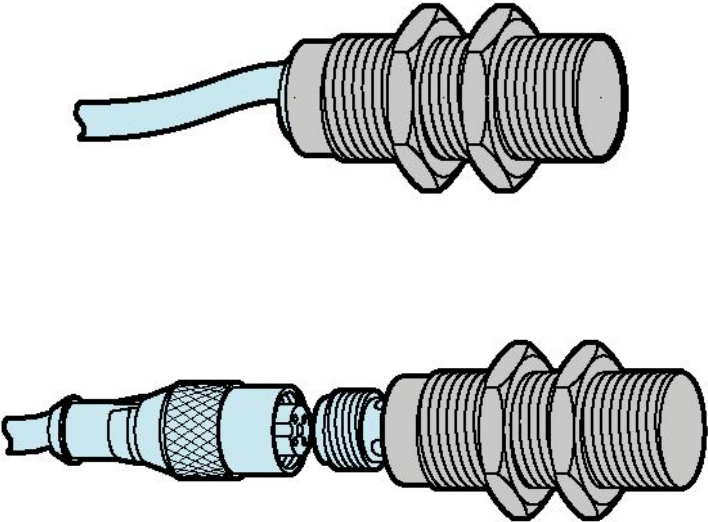

Sensors

Angle sensor - Inclinometer

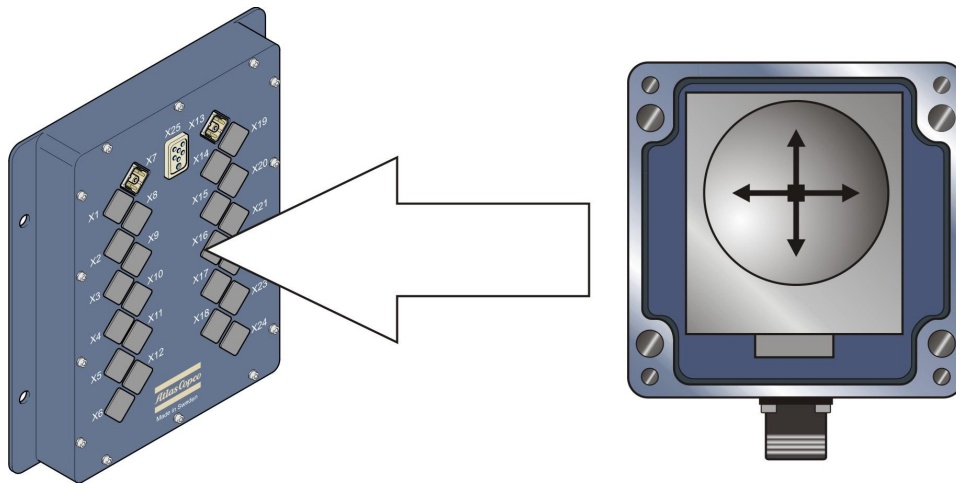

Sensors

Length sensor - Encoder

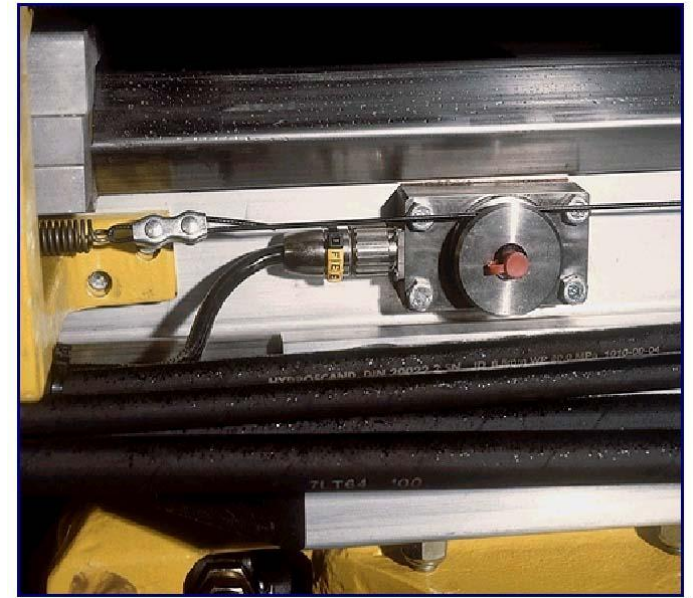
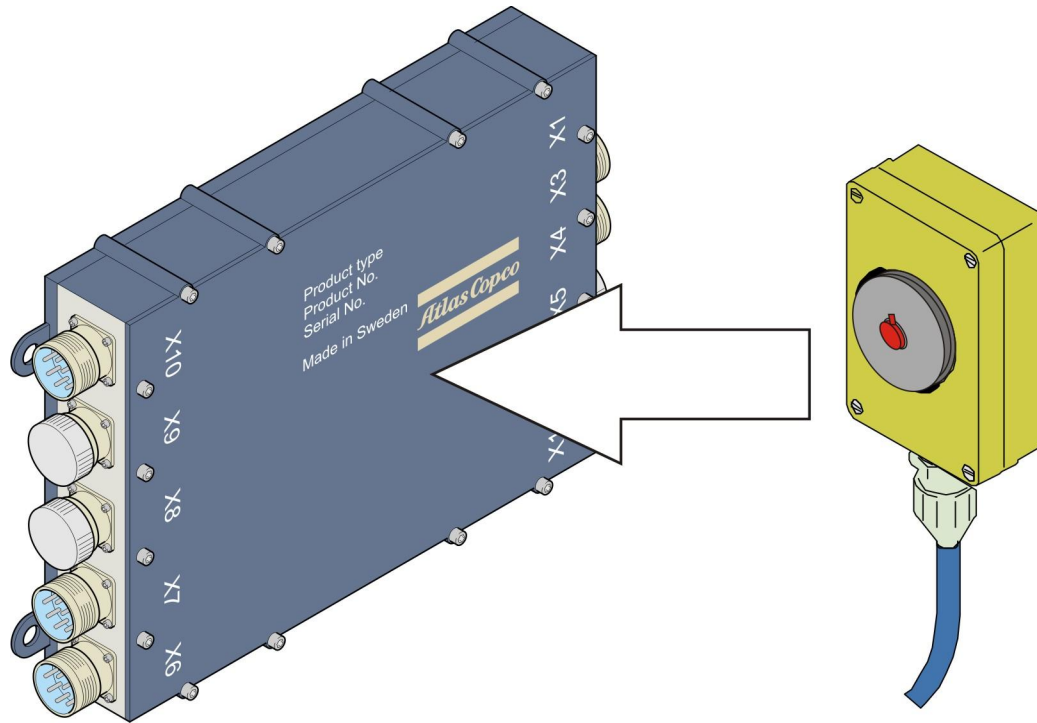

Sensors

Length sensor - Potentiometer

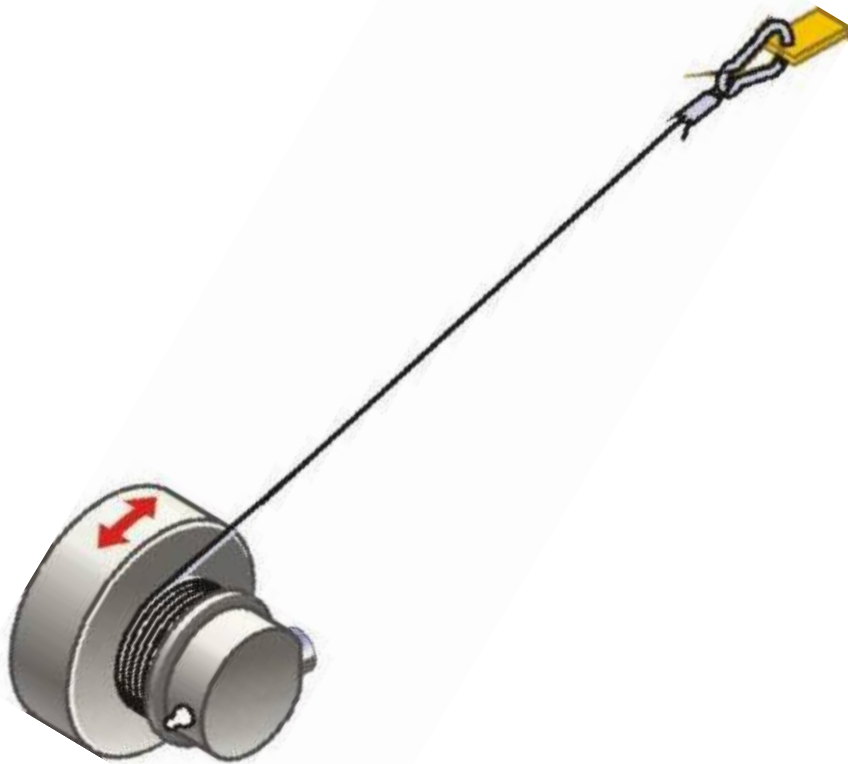

Sensors

Angle sensors – CANBUS Sensors

- Connects directly to the CAN bus
- Standard automotive components



Sensors

Angle sensors – CANBUS Sensors (D171)

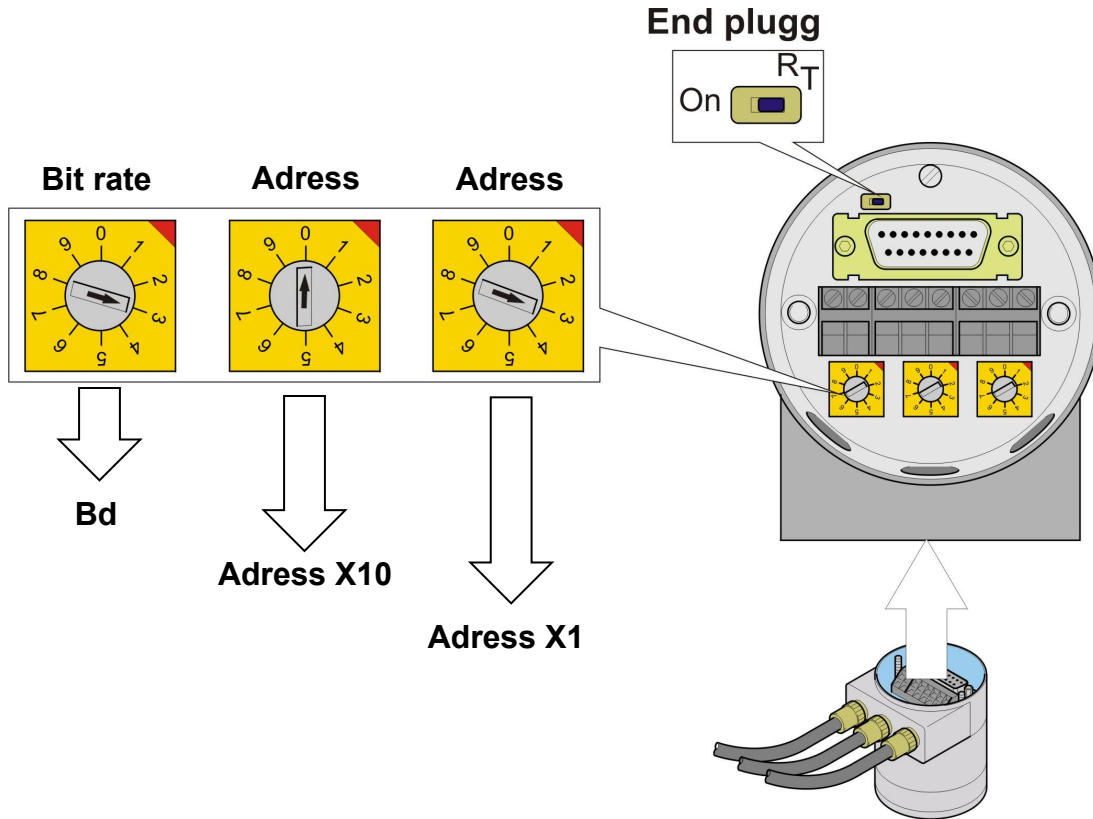

Sensors

Angle sensors – CANBUS Sensors (D171)

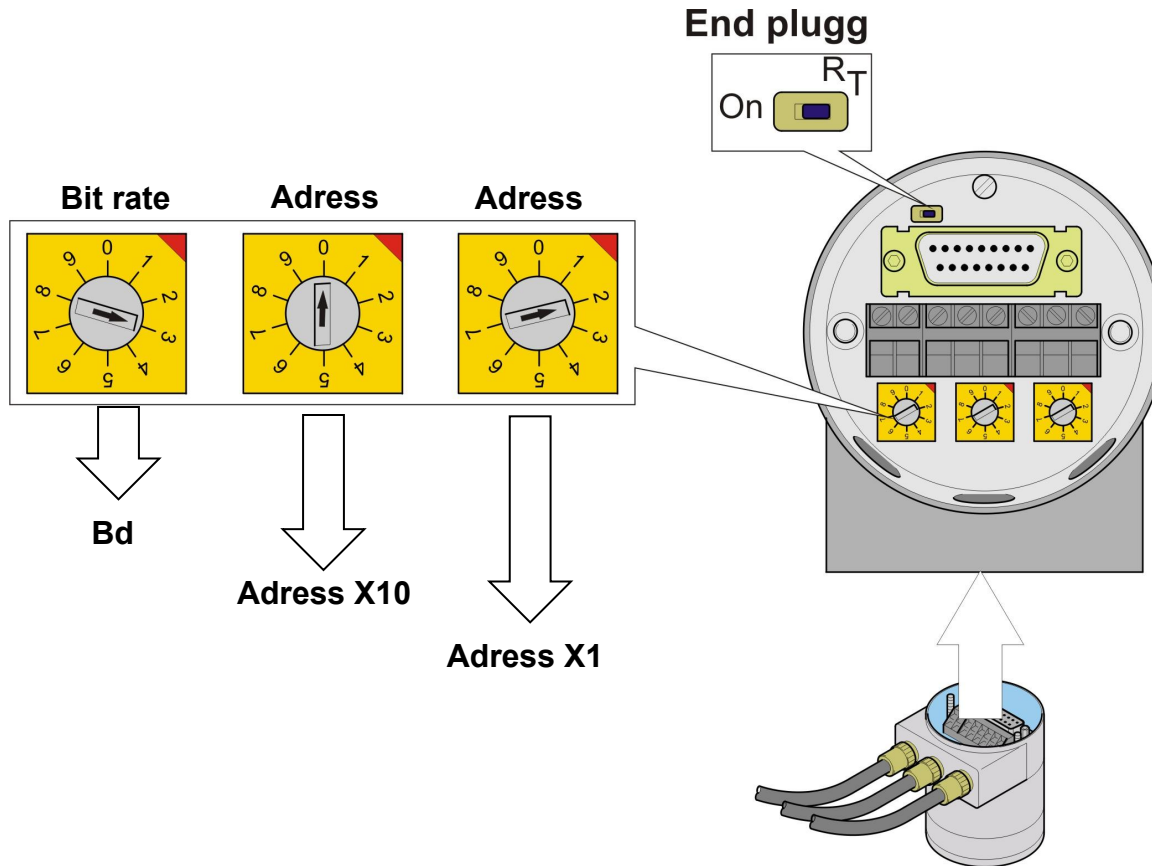

Sensors

Pressure sensors



50 bar

0 - 50bar

Coefficient
61

Air Pressure

Lubrication Pressure



350 bar

0 - 350 bar

Coefficient
427

Hydraulic Pressure

Water Pressure



Sensors

Pressure sensors - Offset



How to find Offset

Coefficient = 100

Offset = 0

New offset = Value x 10

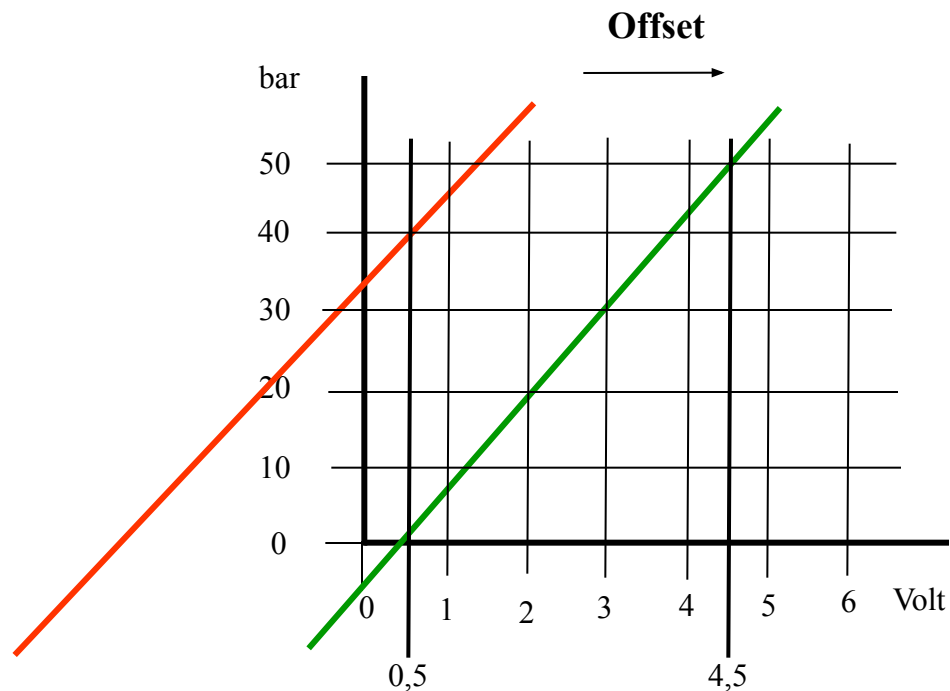

0,5 Volt = 0 bar

Sensors

Pressure sensors - Coefficient

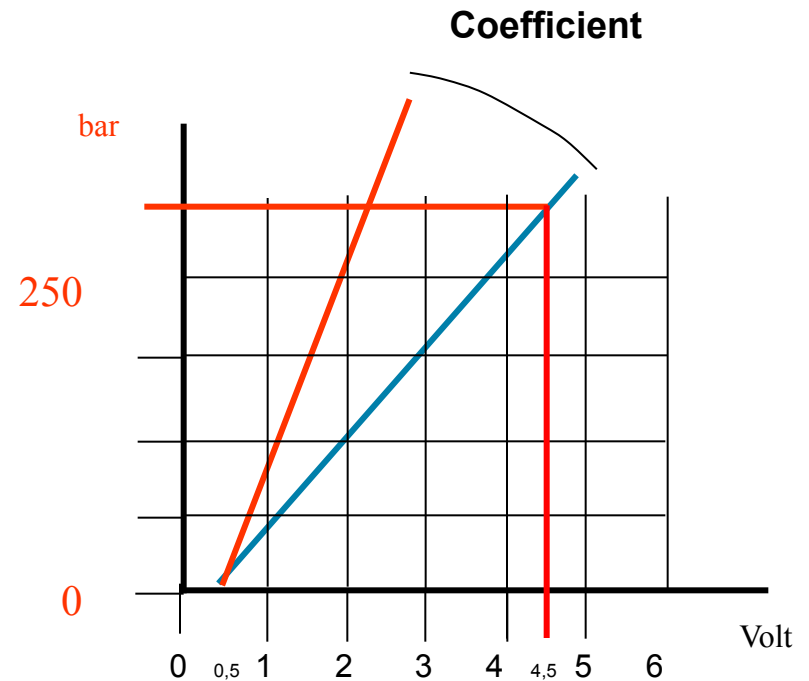
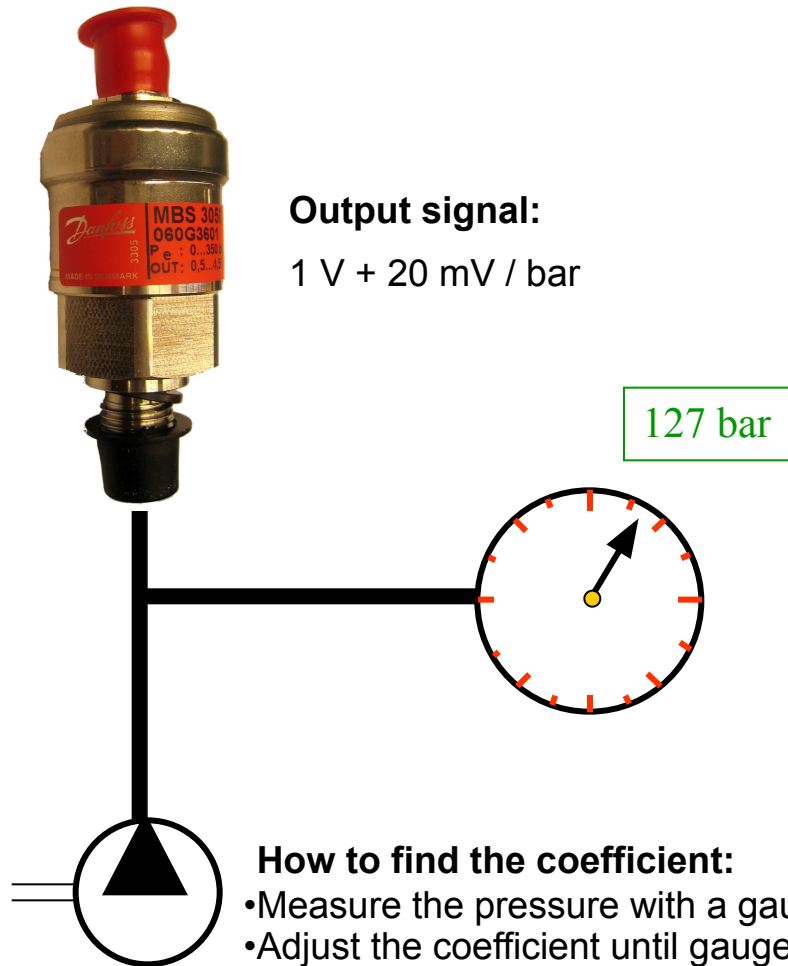

Sensors

Pressure sensors - Calibration

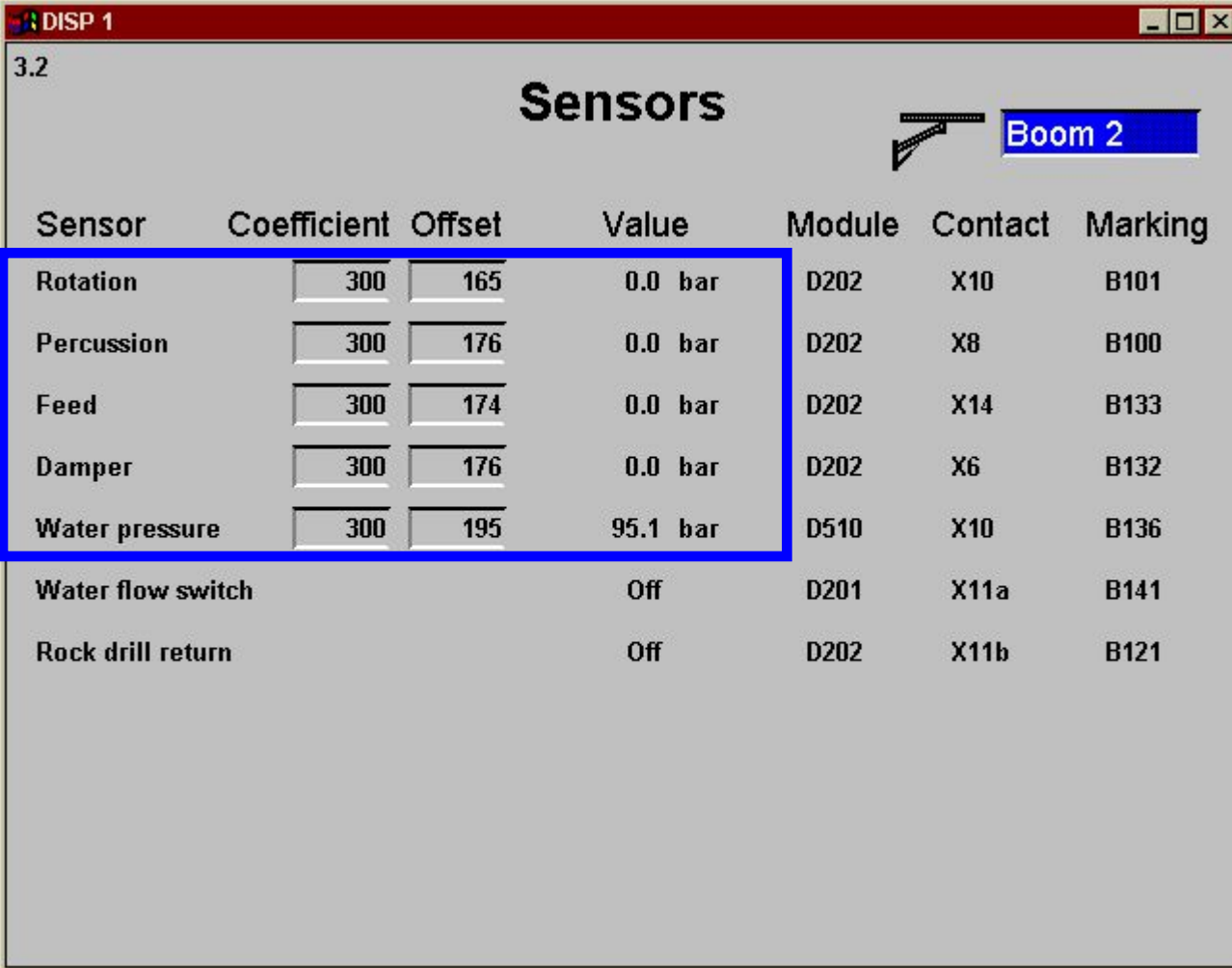

3.2

Sensors

 **Boom 2**

Sensor	Coefficient	Offset	Value	Module	Contact	Marking
Rotation	<input type="text" value="300"/>	<input type="text" value="165"/>	0.0 bar	D202	X10	B101
Percussion	<input type="text" value="300"/>	<input type="text" value="176"/>	0.0 bar	D202	X8	B100
Feed	<input type="text" value="300"/>	<input type="text" value="174"/>	0.0 bar	D202	X14	B133
Damper	<input type="text" value="300"/>	<input type="text" value="176"/>	0.0 bar	D202	X6	B132
Water pressure	<input type="text" value="300"/>	<input type="text" value="195"/>	95.1 bar	D510	X10	B136
Water flow switch			Off	D201	X11a	B141
Rock drill return			Off	D202	X11b	B121

Sensors

Pressure sensors - Calibration

Display_1

M3.1

Sensors

Boom 1

Sensor	Set to zero	Value	Module	Contact	Marking
Feed pressure	<input checked="" type="checkbox"/>	0.0 bar	D102	X14	B133
Rotation pressure	<input type="checkbox"/>	0.0 bar	D102	X10	B101
Percussion pressure	<input type="checkbox"/>	0.0 bar	D102	X8	B100
Damper pressure	<input type="checkbox"/>	44.8 bar	D102	X6	B132
Water pressure	<input type="checkbox"/>	19.9 bar	D510	X10	B136
Water flow		0	D102	X11a	B141
Rock drill return		0	D102	X11b	B121
Cradle position	<input type="button" value="Calibrate"/>	0.000 m	D120	R10	B307

**We are committed to your
superior productivity through
interaction and innovation.**



Atlas Copco

