

Біологічна роль головного комплексу гістосумісності МНС

(МНС - від англ. – *major histocompatibility complex*).

1. Вкажіть стрілочками активаційні зв'язки між клітинами ІС

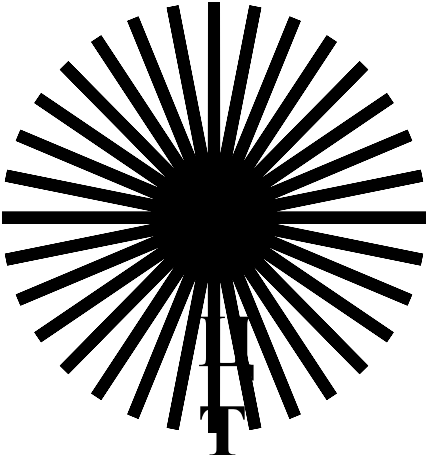
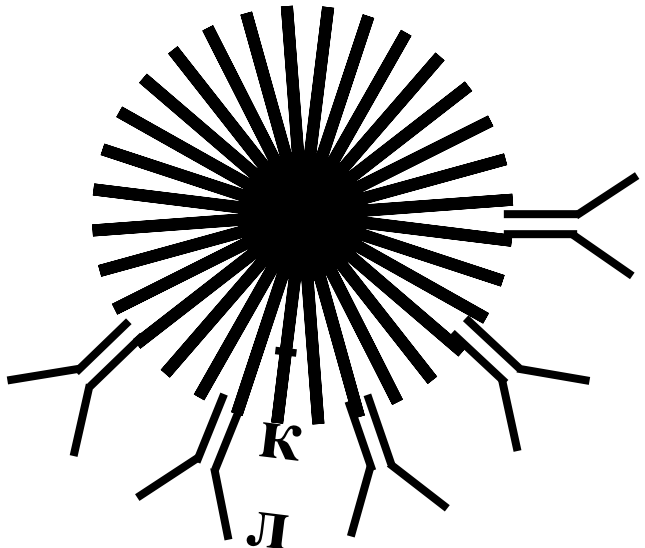
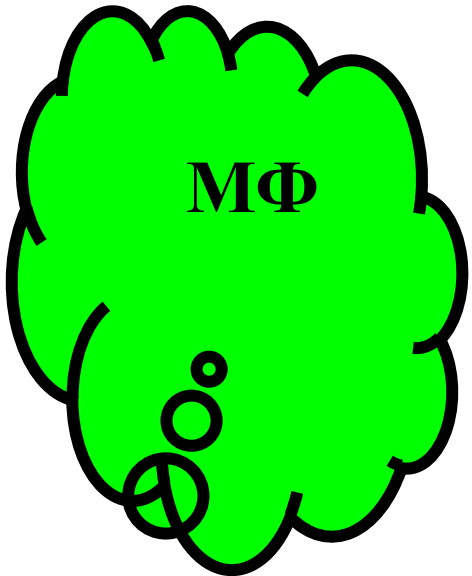

Л

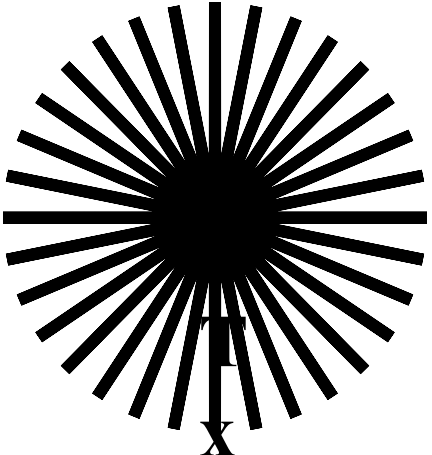

1

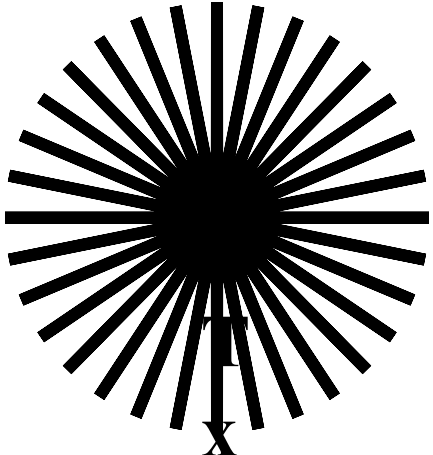

2

Презентація антигенів

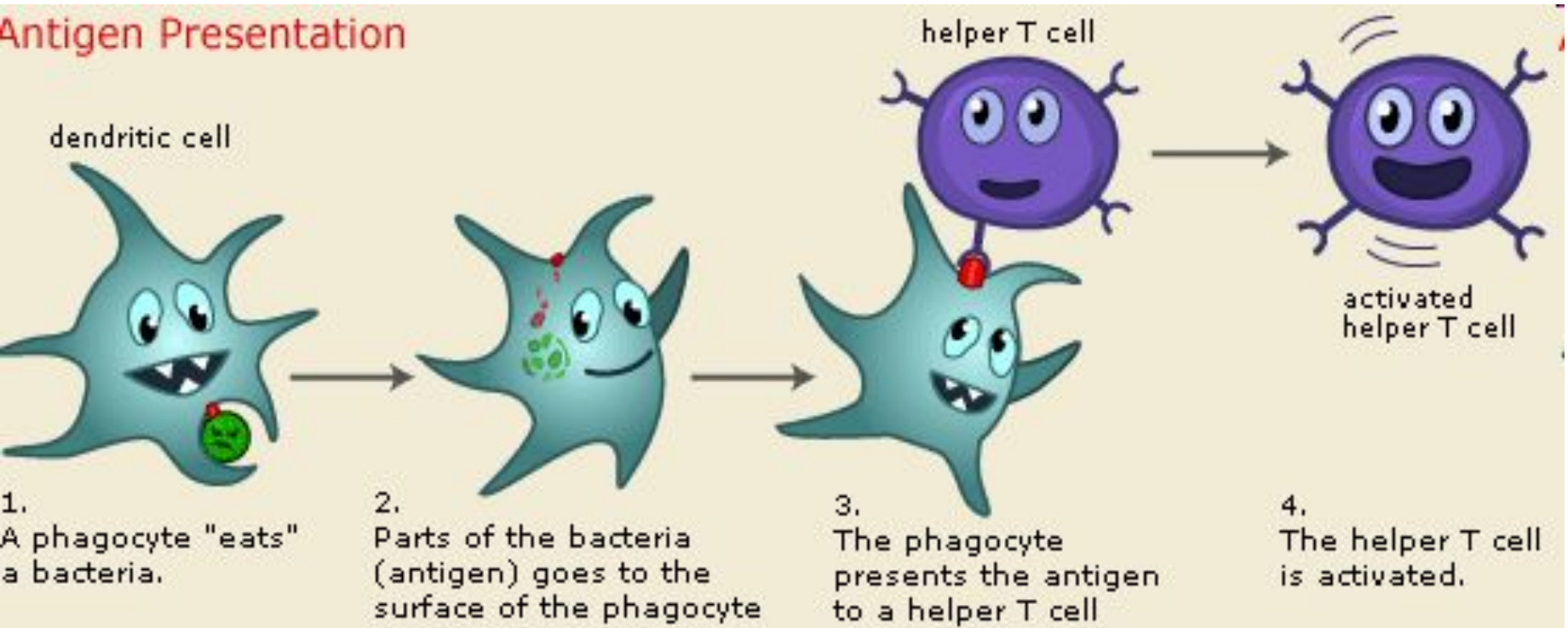



Бару Бенецераф, Жан Доссе і Джордж Снелл



1920 р.н.



1916 р.н.



1903-1996

Нобелівська премія (1980 р)

за відкриття головного комплексу
гістосумісності

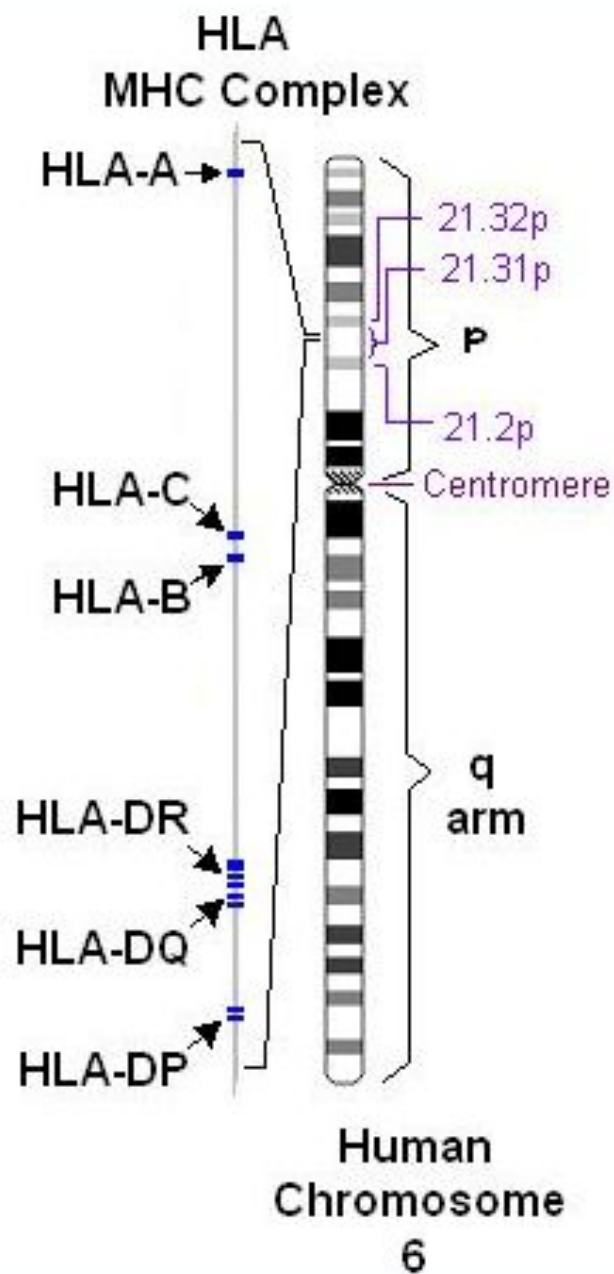

Gene structure of the human MHC

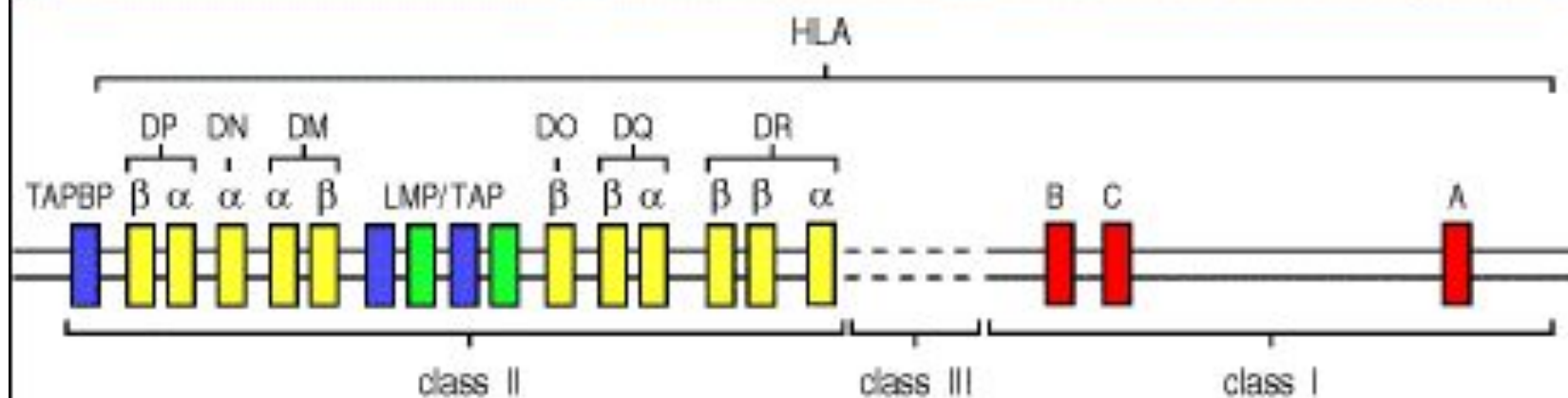

Gene structure of the mouse MHC

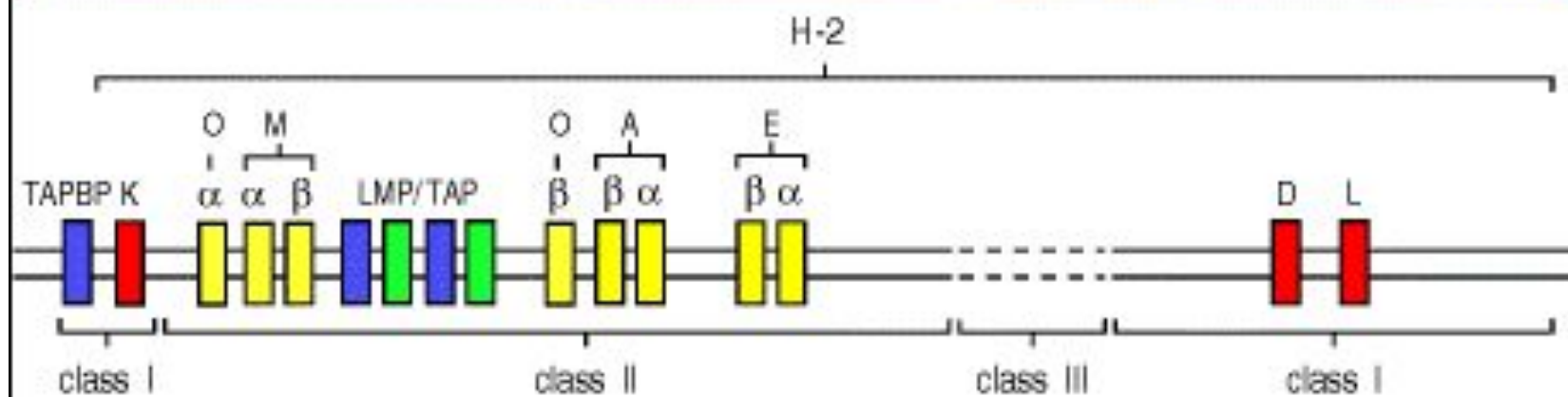

Пітер Догерті і Рольф Цинкернагель



Нобелівська премія (1996 р)

за відкриття МНС-рестрикції імунної відповіді

Схематична будова білків МНС I і МНС II

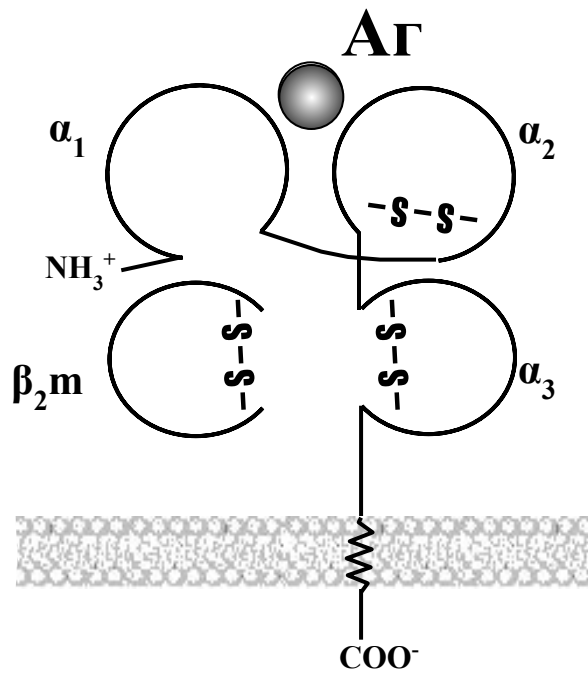

МНС I

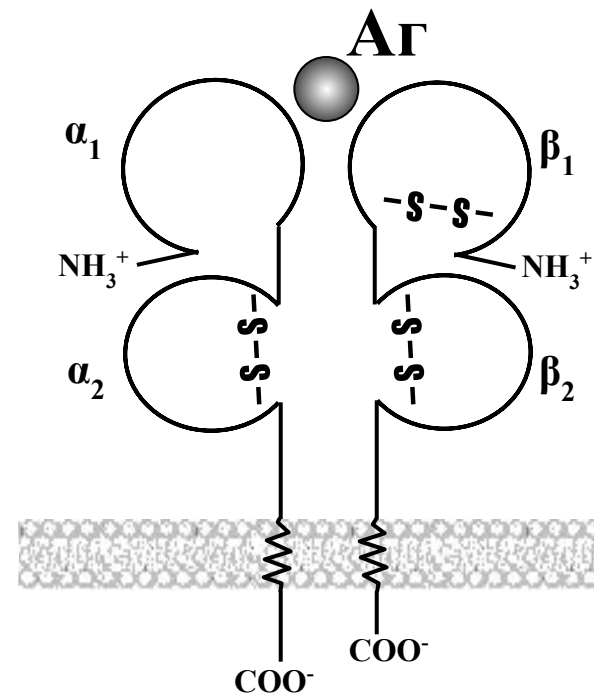

МНС II

Трьохмірна будова білків МНС I і МНС II

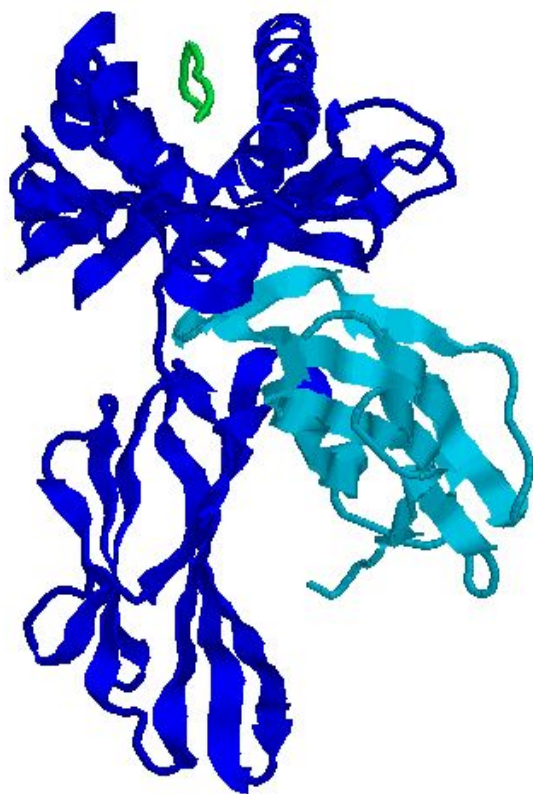

МНС I

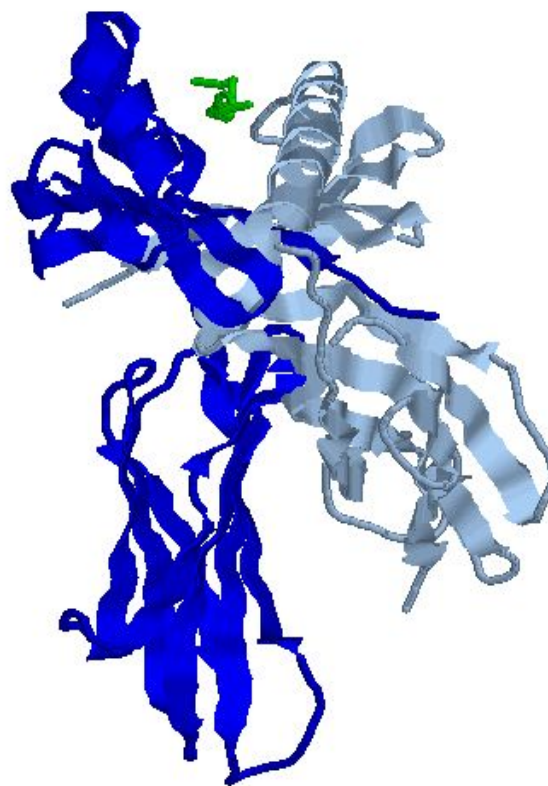

МНС II

Будова “активних центрів” МНС I і МНС II

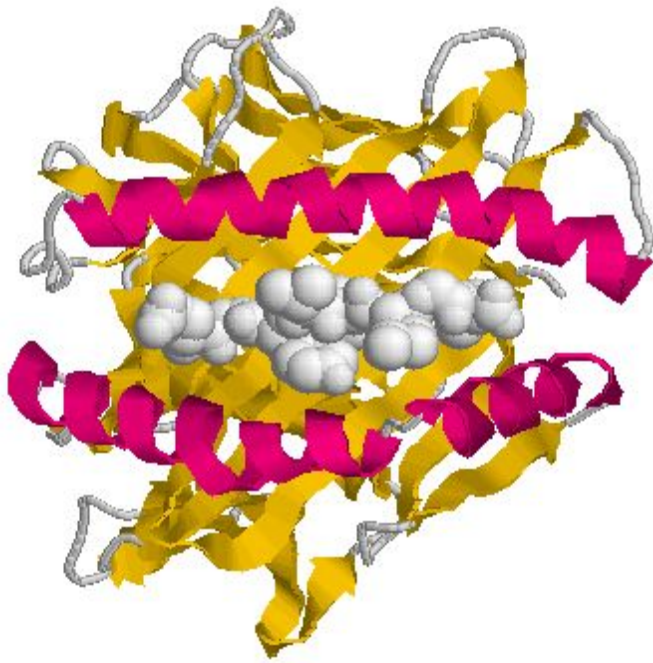

МНС I

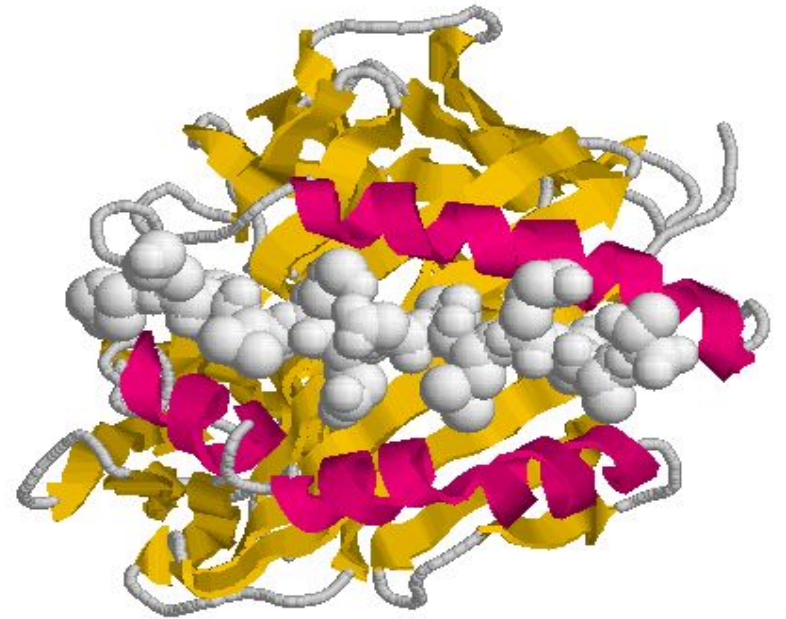

МНС II

Розміщення МНС I і МНС II на мембрані клітин

7272 Biophysics: Jenei *et al.*

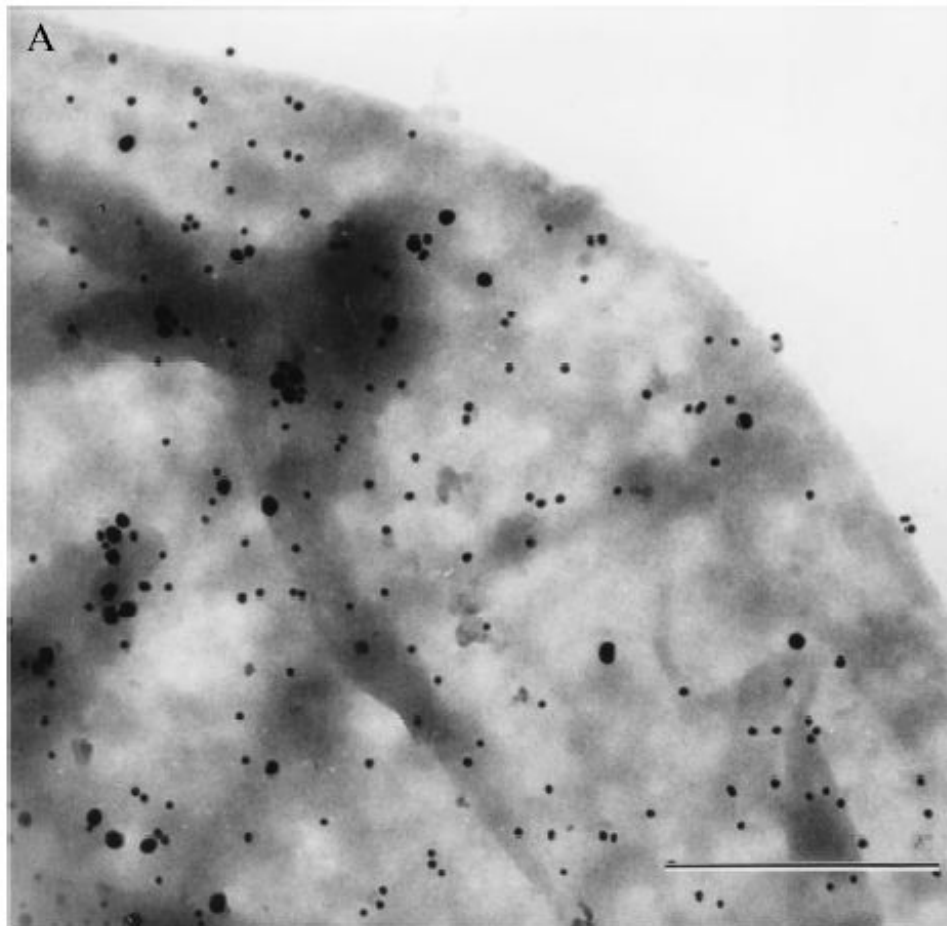

Антитіла до МНС I –
мічені 15 нм. кол.
золотом (маленькі
кульки)

Антитіла до МНС II –
мічені 30 нм. кол.
золотом (великі
кульки)

Біологічна роль антигенів МНС І

Будь-яка клітина організму може бути місцем перебування внутрішньоклітинних патогенів

- Імунна система повинна мати доступ до інформації про те, що робиться в середині кожної клітини
- Цю інформацію забезпечують антигени МНС I-го класу, які присутні майже на всіх клітинах організму

Вбивство уражених клітин Т-кілерами

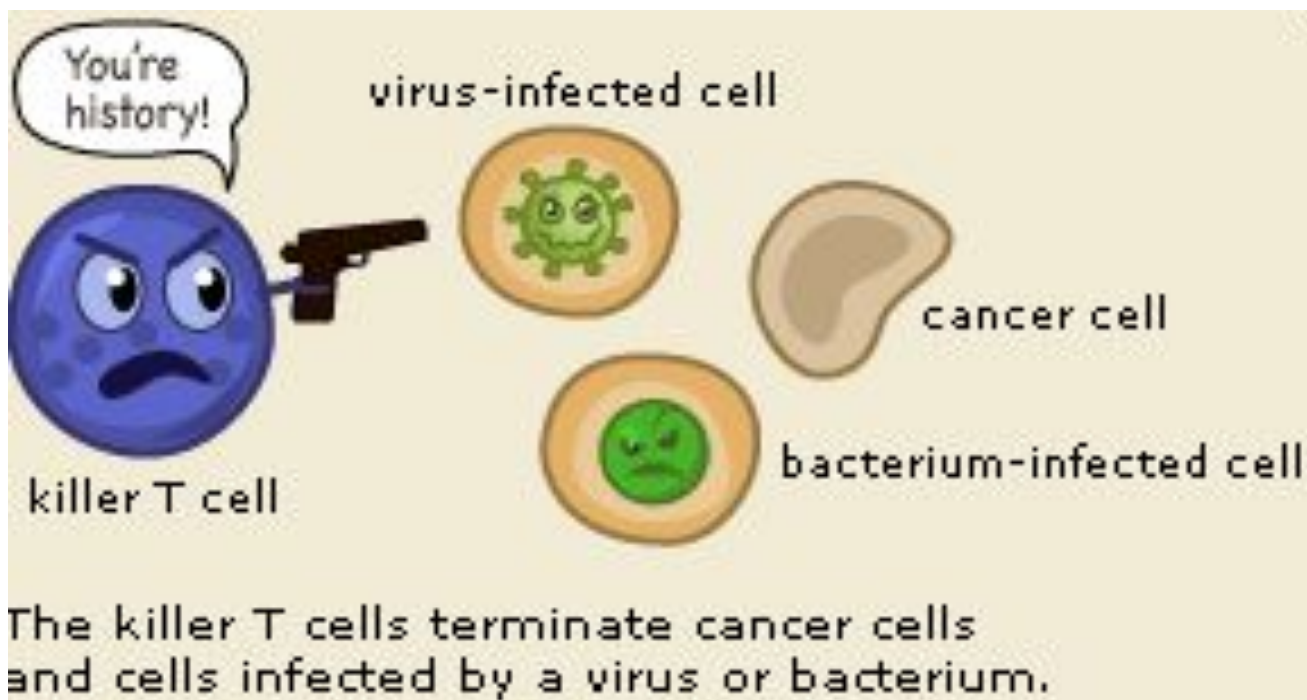

Структура протеосомы

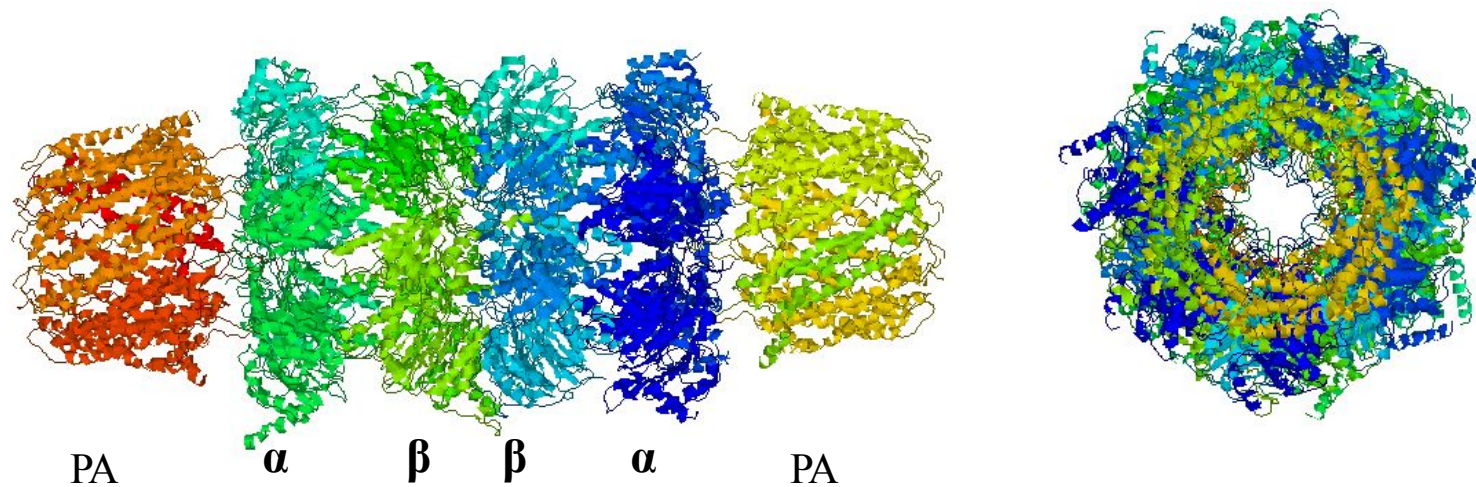

Плазматична мембрана

Апарат Гольджі

Ендоплазматичний ретикулум

β_2 -мікроглобулін

Пептиди

ТАП

Тапасін

Калретикулін

α -ланцюг МНС
+
калнексін

Протеасома

Молекула
ендогенного
білка

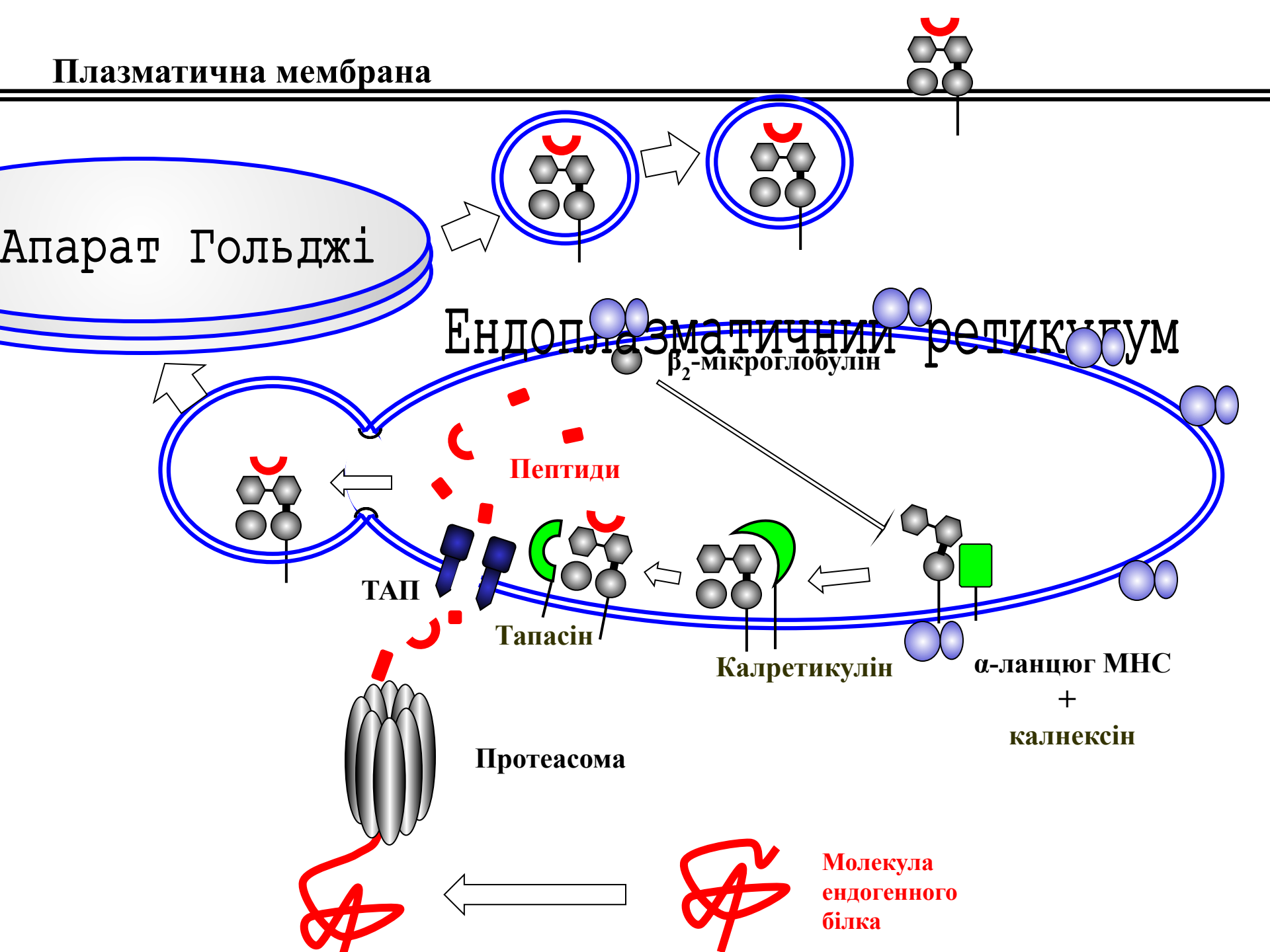

Плазматична мембрана

Апарат Гольджі

Ендоплазматичний ретикулум

β_2 -мікроглобулін

Пептиди

ТАП

Тапасін

Калретикулін
+ МНС I

α -ланцюг МНС
+
калнексін

Протеасома

Молекула
ендогенного
білка

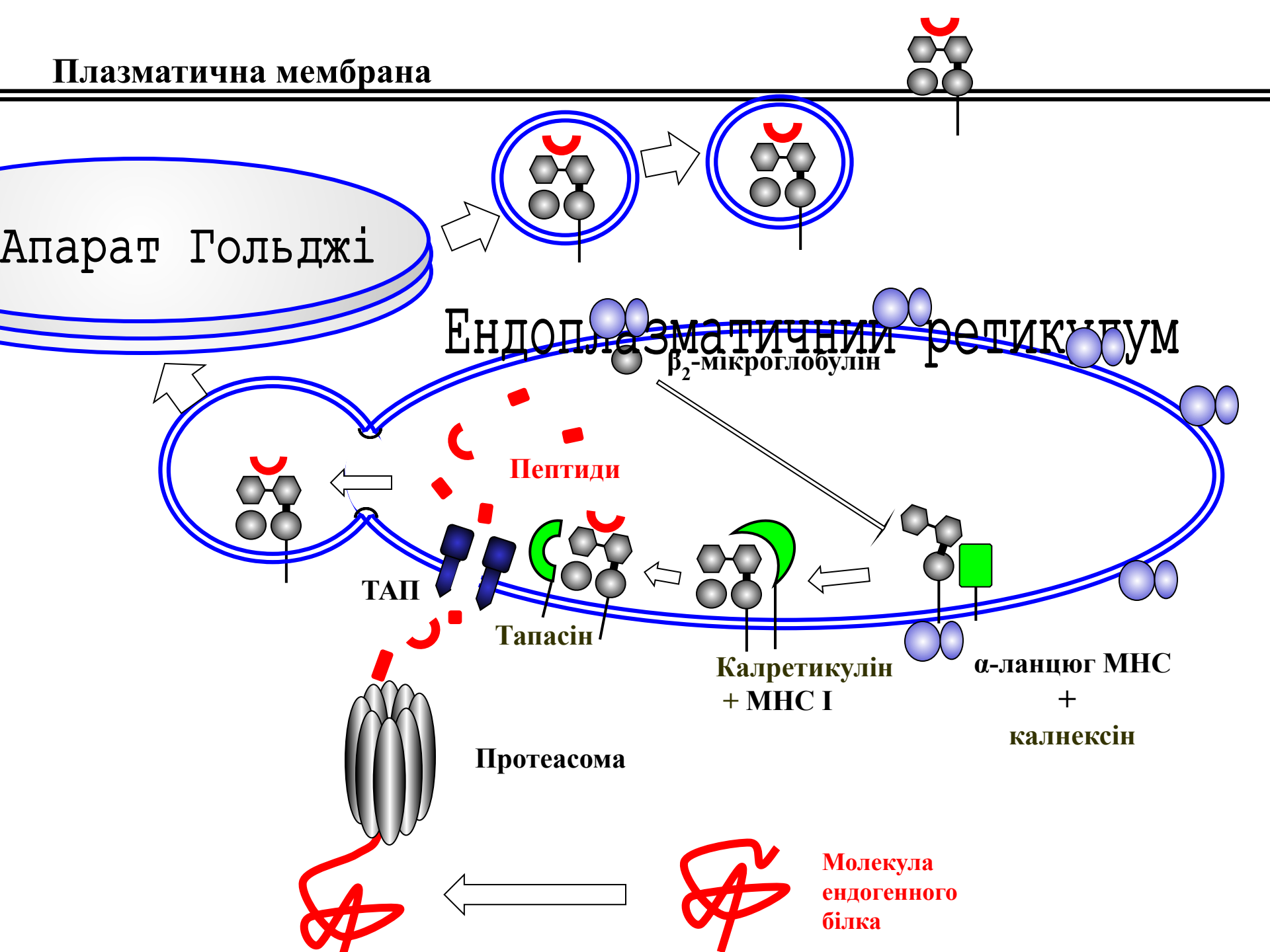

Деякі віруси виробили засоби впливу на систему МНС I

<u>Virus</u>	<u>Protein</u>	<u>Effect on class I</u>
Adenovirus	E3-k19	Retain in ER
HSV-1,2	ICP47	Blocks TAP
EBV	EBNA1	Block peptide generation
HCMV	US2, US11	ER to cytosol
HCMV	US3	Retain in ER
HCMV	US6	Blocks TAP
HCMV	US10	Degrades HLA-G
MCMV	m152	Retain in ER
MCMV	m04	Associates with H-2
MCMV	m06	Lysosomal degradation
HHV8	K3, K5	Endocytosis
HIV-1	Nef	Endocytosis

Схема інгібування активності природних кілерів

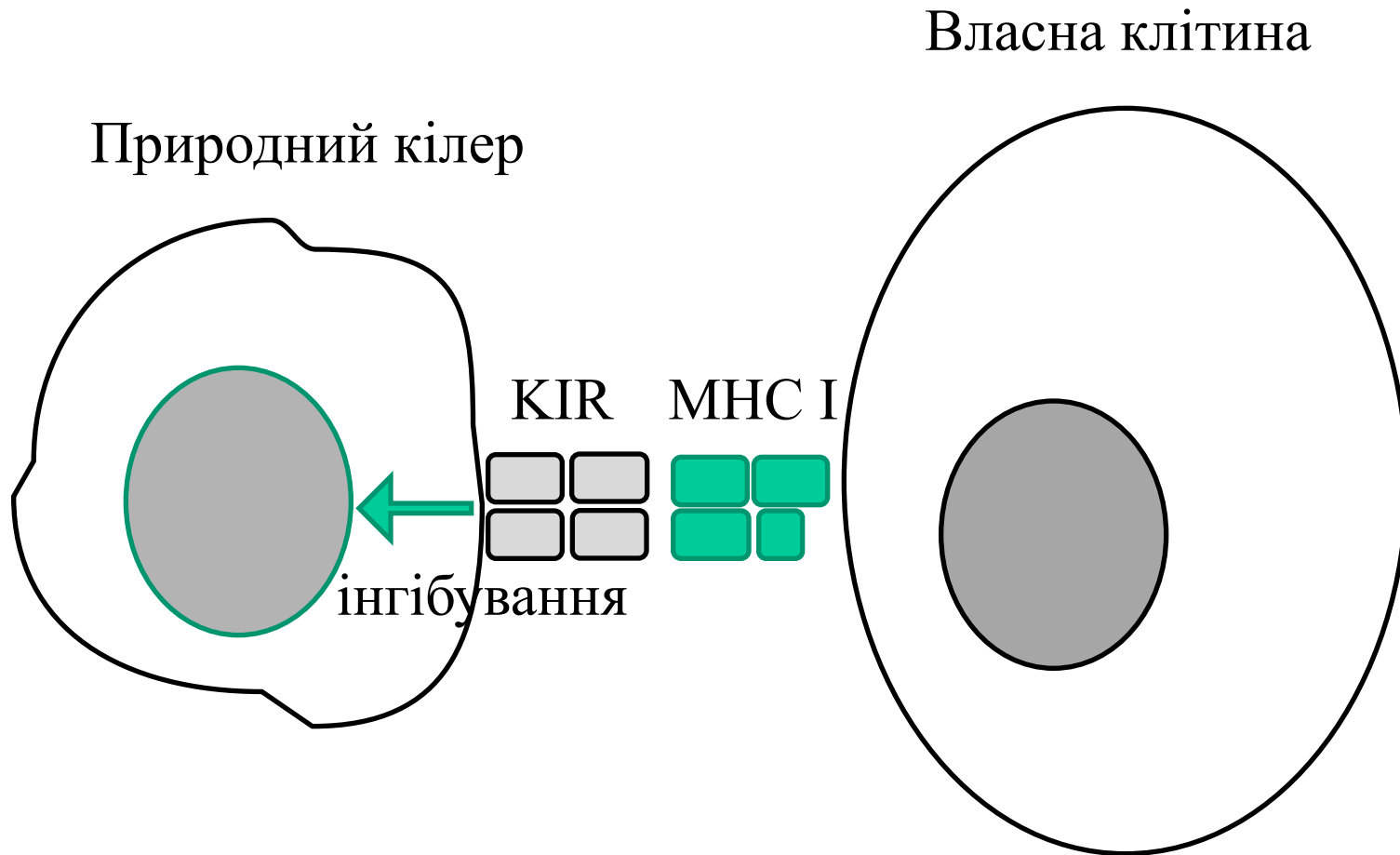

NK cells like to kill cells lacking MHC class I – “missing-self”

NK Cells Reject Tumors Lacking MHC Class I

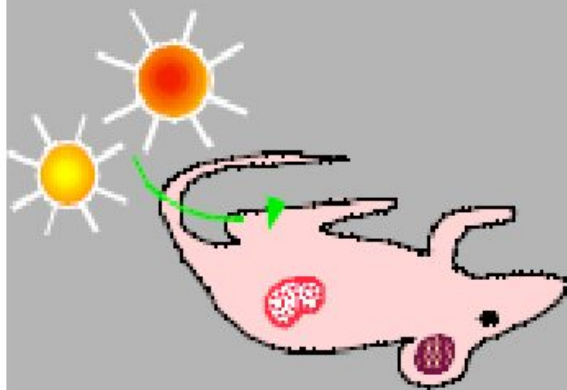

Class I⁺ tumors
grow *in vivo*

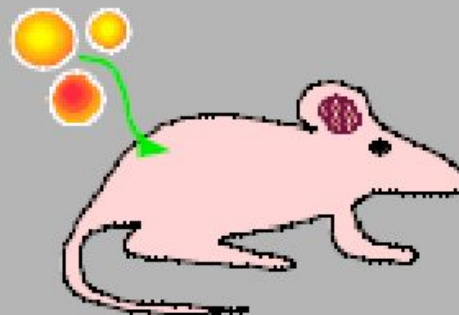

Class I⁻ tumors
are rejected

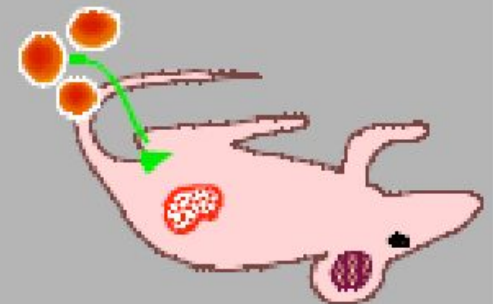

Class I⁻ tumors
in NK-depleted
mice grow *in vivo*

Karre et al. 1986 Nature 319:675

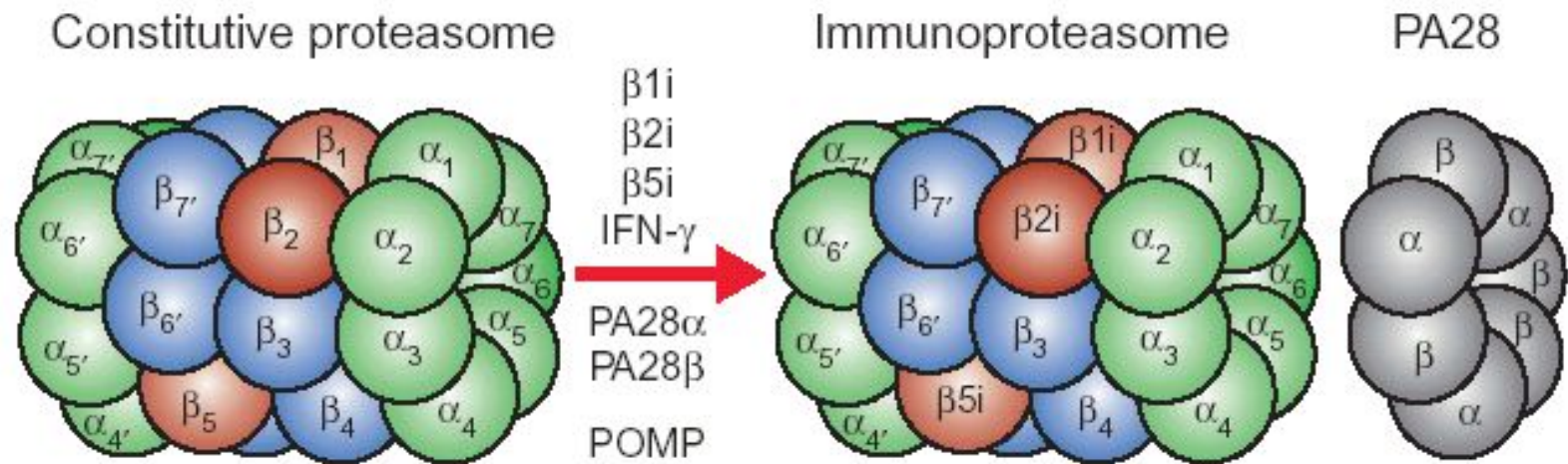

low molecular weight protein LMP 2, LMP7
 multicatalytic endopeptidase complex-like 1 (MECL1)

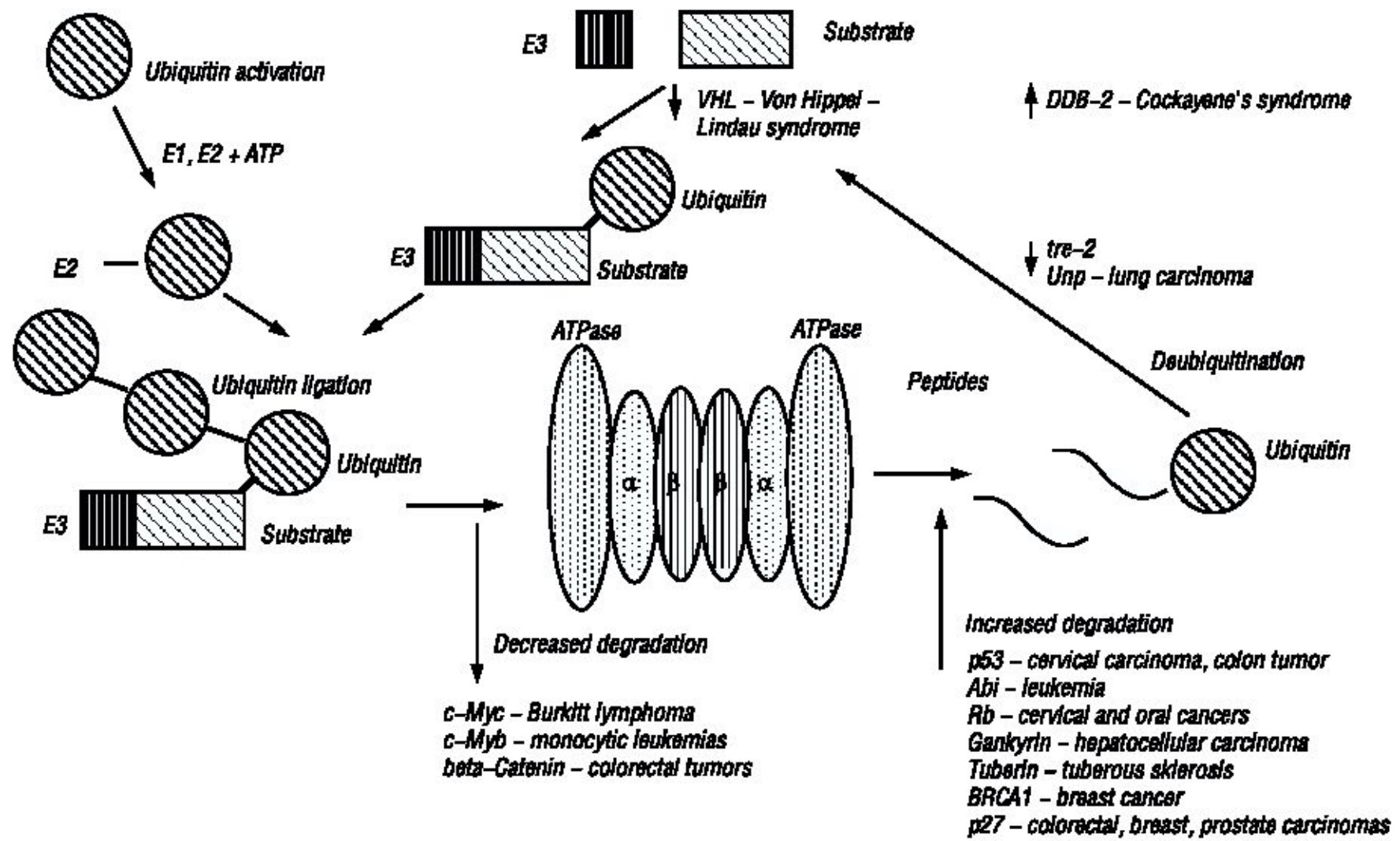

Біологічна роль антигенів МНС II

МНС II-го класу відповідають за комунікацію клітин імунної системи під час імунної відповіді

- МНС II-го класу необхідні для обміну інформацією про антиген між різними клітинами
- Тому клітини, що експресують МНС II-го класу, називають Антиген-Презентувальними Клітинами (АПК)

Презентація антигену – представлення антигену на поверхні клітин для розпізнавання іншими клітинами

1. В-клітини
2. макрофаги
3. Дендритні клітини

здатні до поглинання і процесінгу (розрізання)
антигену, а також до презентації його
фрагментів в комплексі з антигенами
гістосумісності II класу (МНСII)

Поглинання антигенів

- | | |
|----------------------|----------------|
| 1. В-клітини | ендоцитоз АГ |
| 2. Макрофаги | фагоцитоз |
| 3. Дендритні клітини | макропіноцитоз |

Functional and ultrastructural evidence for intracellular formation of major histocompatibility complex class II–peptide complexes during antigen processing

(endosomes/immunocytochemistry/endocytosis)

CLIFFORD V. HARDING*, EMIL R. UNANUE*, JAN W. SLOT[†], ALAN L. SCHWARTZ[‡], AND HANS J. GEUZE[†]

[†]Department of Cell Biology, Medical School, University of Utrecht, 3584 CX, Utrecht, The Netherlands; and *Department of Pathology and [‡]The Edward Mallinckrodt Departments of Pediatrics and Pharmacology, Washington University School of Medicine, Saint Louis, MO 63110

Contributed by Emil R. Unanue, May 3, 1990

Позаклітинний простір

Ендосома

Лізосома

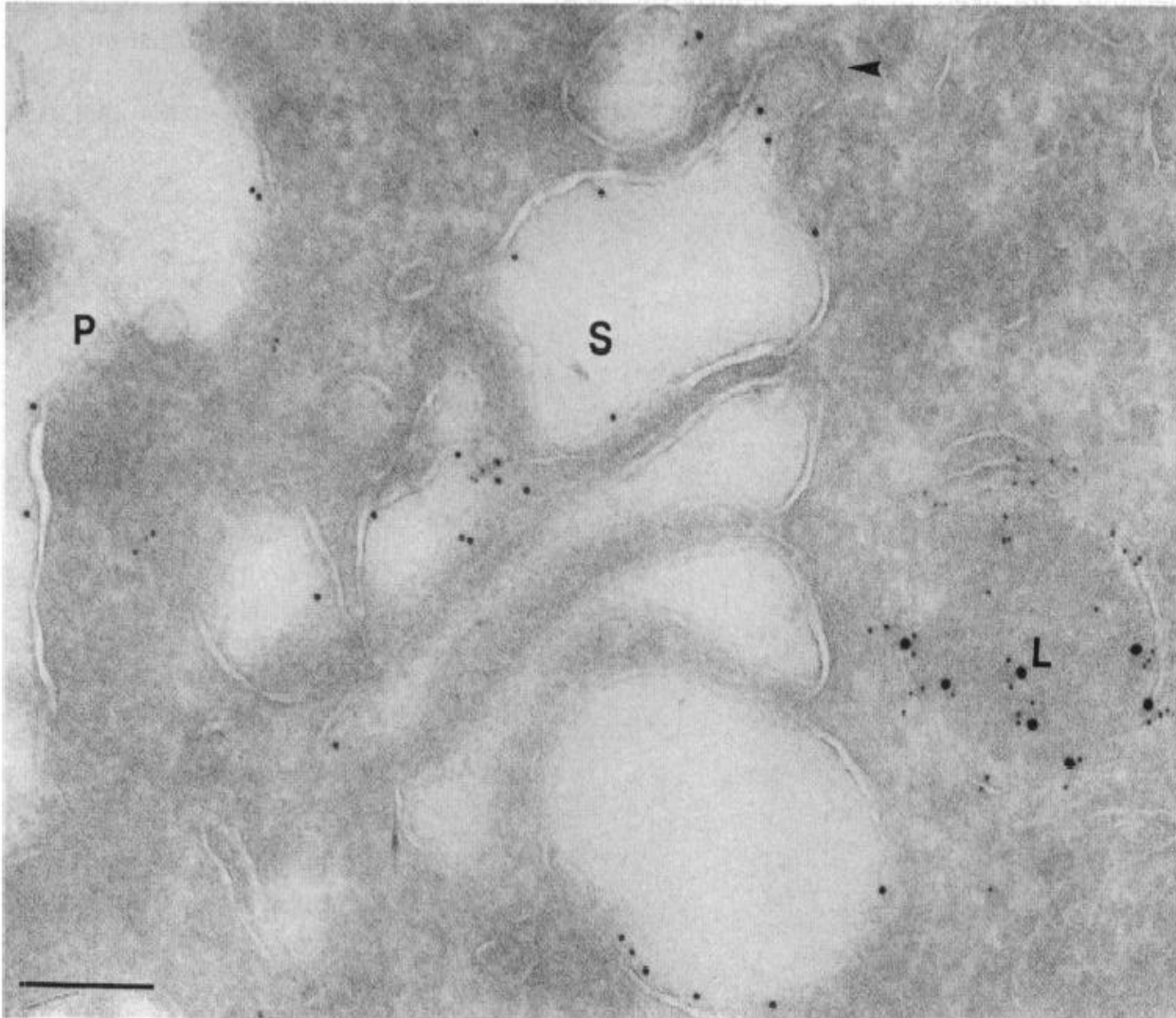
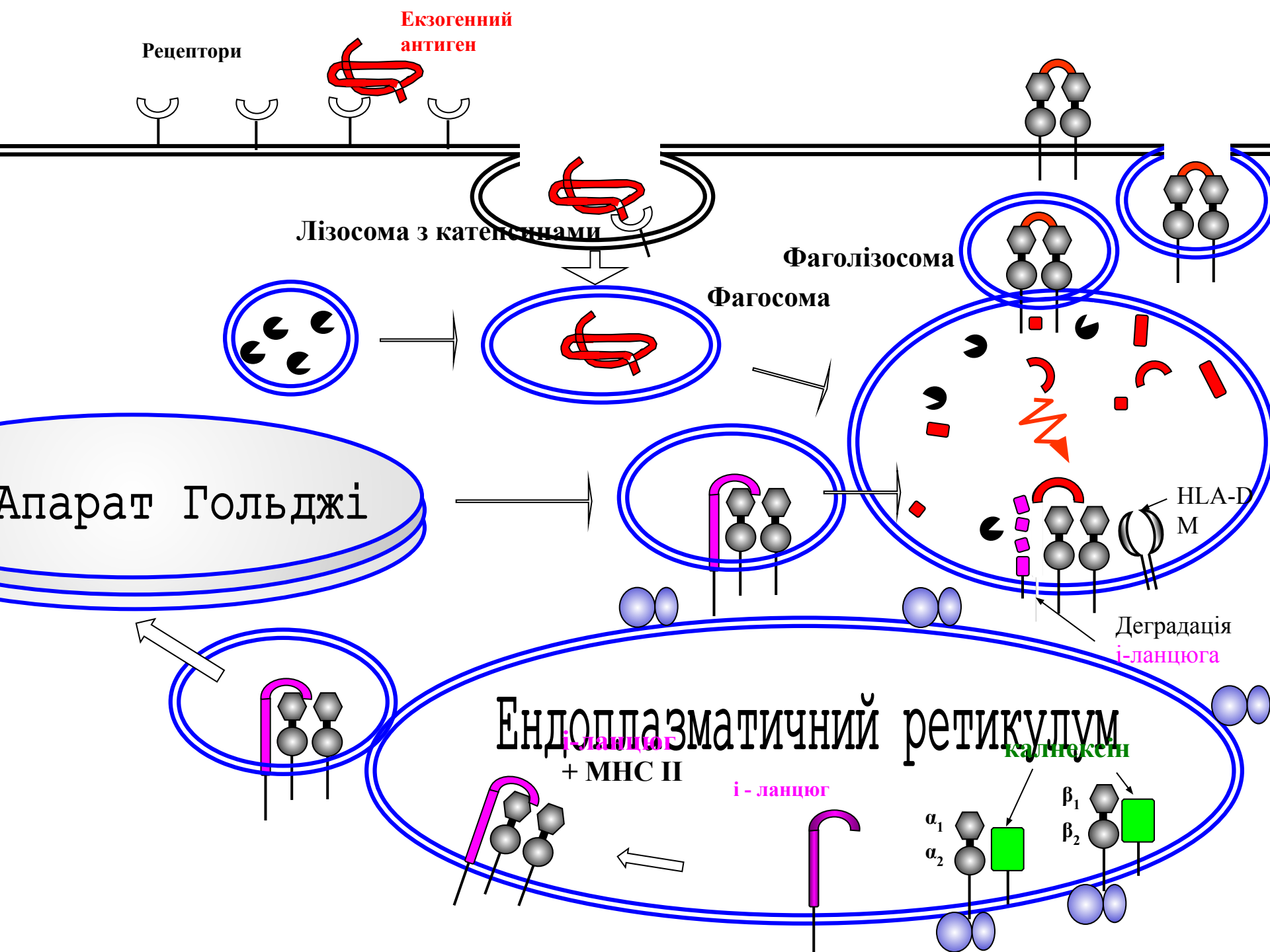
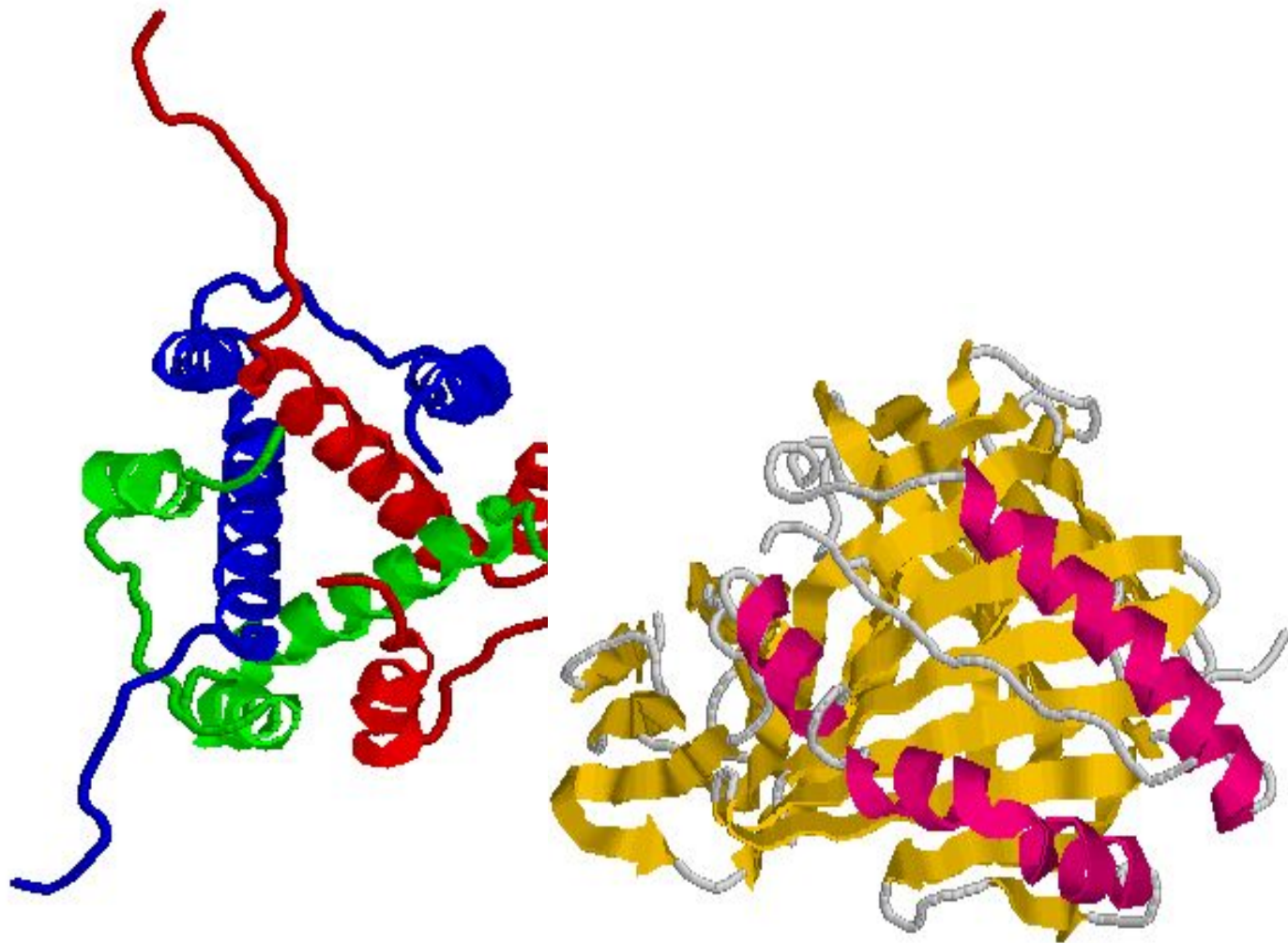
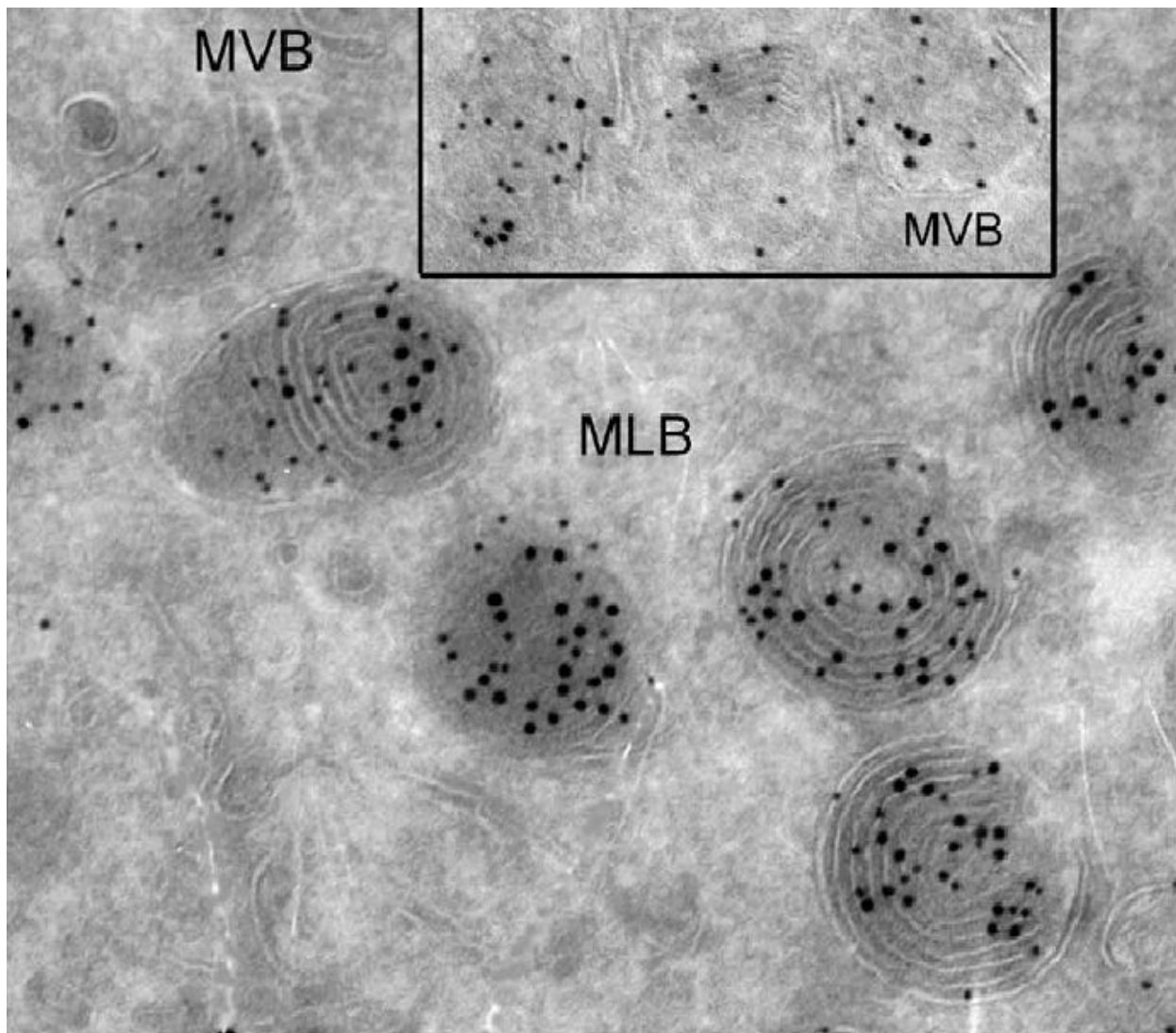

FIG. 2. Triple immunolabeled cryosection of a macrophage to show the presence of MHC-II (10-nm gold) at the plasma membrane (P) and in endocytic sacs (S). MHC-II is absent from a coated pit at the sac membrane (arrow-head) and from the homogeneously dense lysosome (L). The latter shows cathepsin D (15-nm gold) and lamp 1 (5-nm gold), which are both absent from the sacs. (Bar = 0.2 μm ; $\times 72,800$.)



Будова І-ланцюга





МНС компартмент

(за Lawrence J Stern, Ilaria Potolicchio and Laura Santambrogio)

MVB-мультивезикулярний, MLB-мультиламелярний

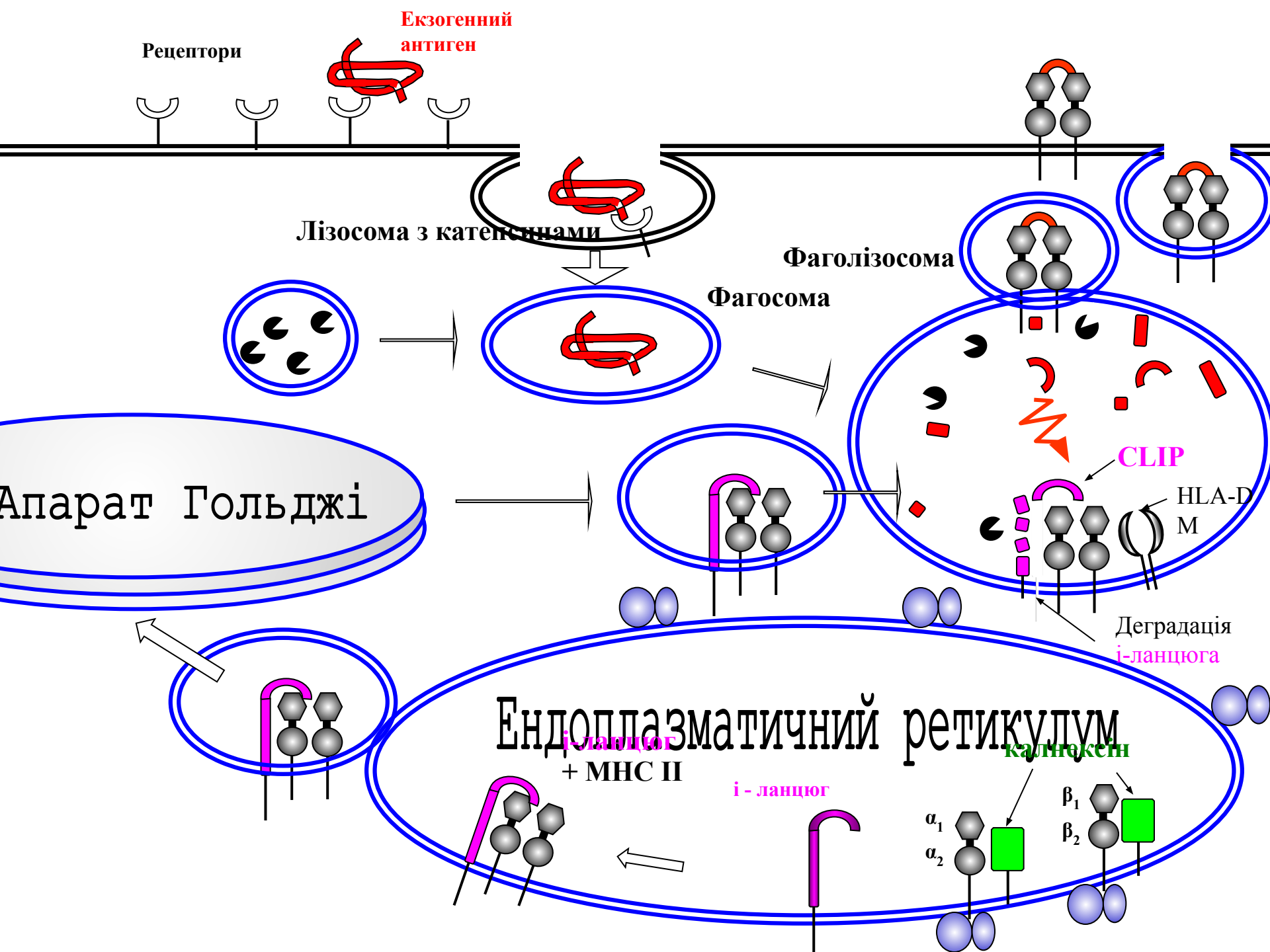

Перехресна презентація антигенів

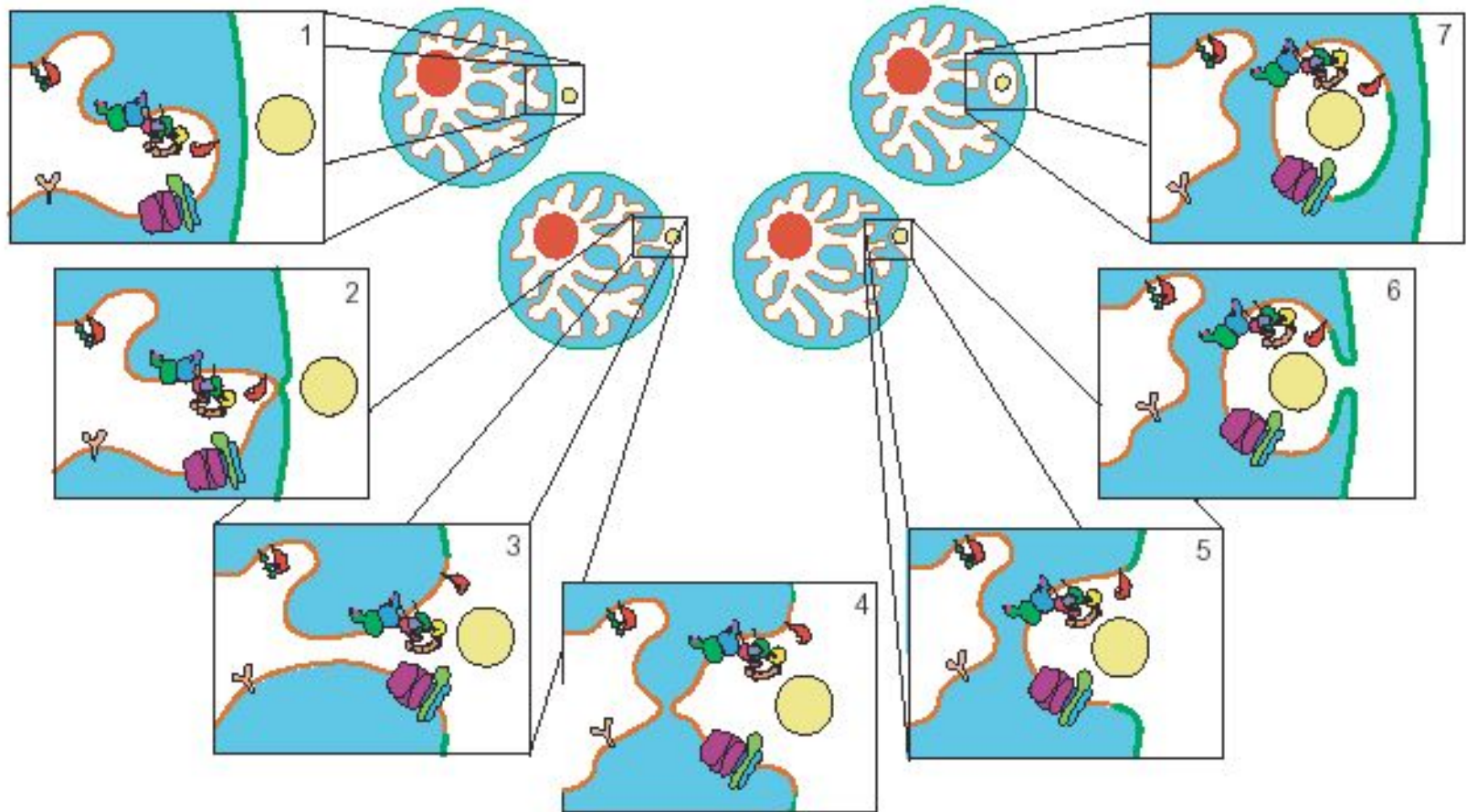

- Sec61 complex
- MHC class I loading complex
- Calnexin
- Calnexin-MHC class I heavy chain
- EDEM
- Latex bead
- ER-derived membrane
- Plasma membrane

Дендритні клітини також здатні презентувати поглинутий антиген з антигенами гістосумісності І-го класу і активувати Т-кілери

- Всі інші клітини в організмі здатні презентувати внутрішньоклітинні білки разом з МНС І, але не здатні активувати Т-кілери (вони можуть лише знищуватись, у разі небезпеки, активованими Т-кілерами)

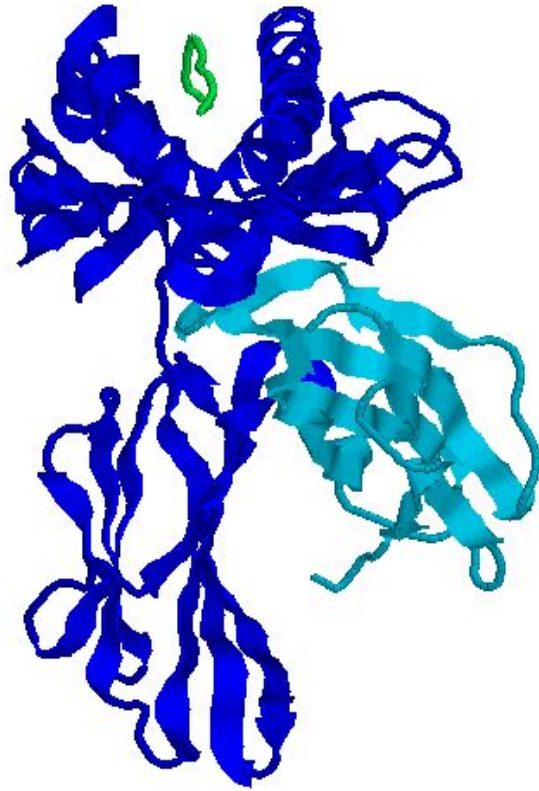

MHC I

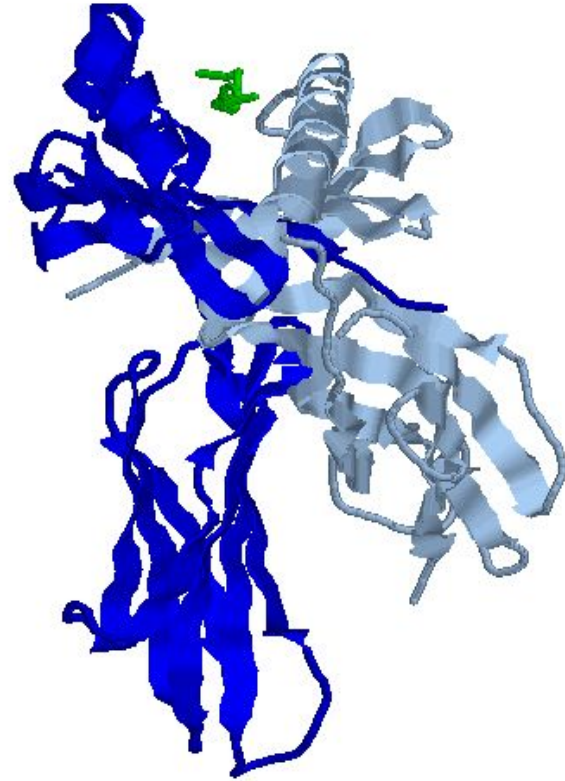

MHC II

Розпізнавання антигену з МНС

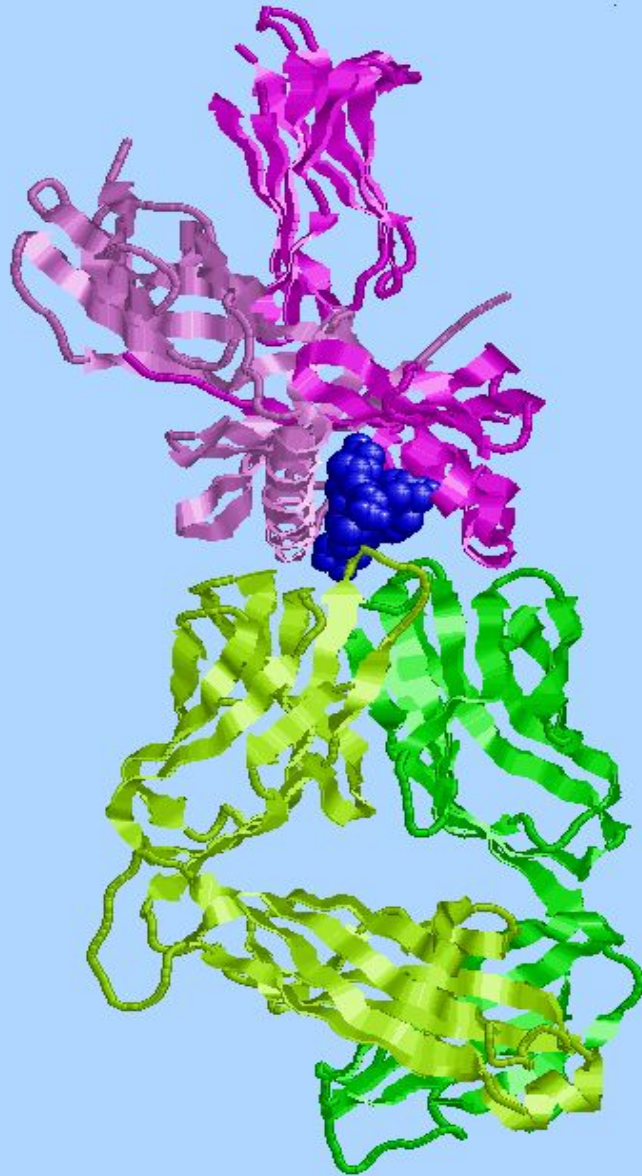

МНС

АГ

ТКР

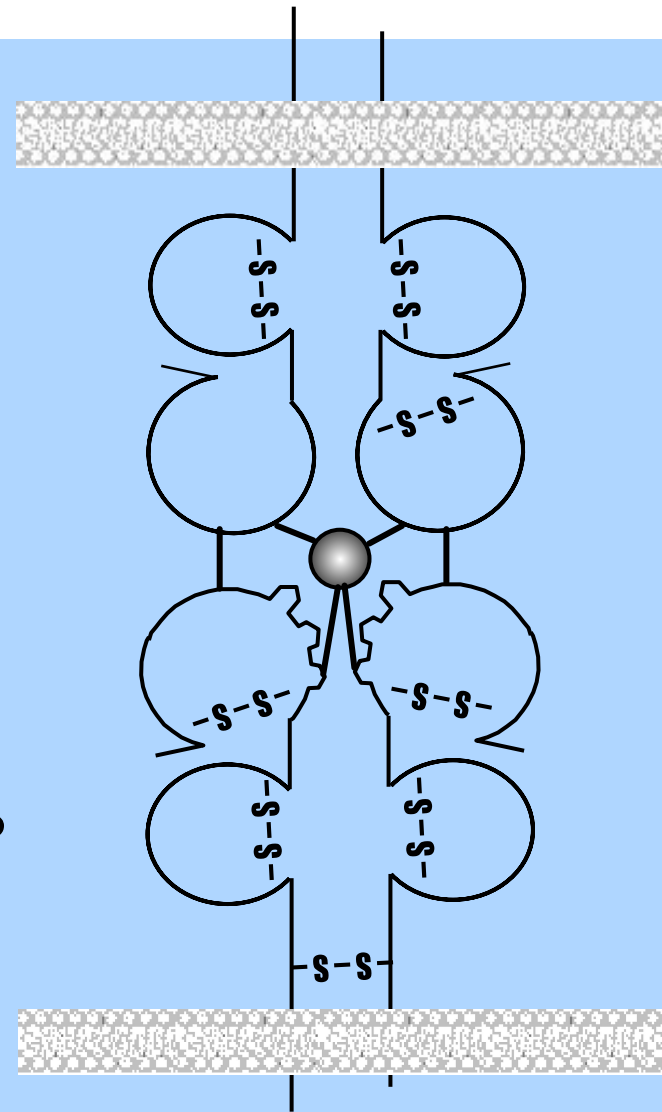

Порівняння будови активних центрів антитіла та ТКР.

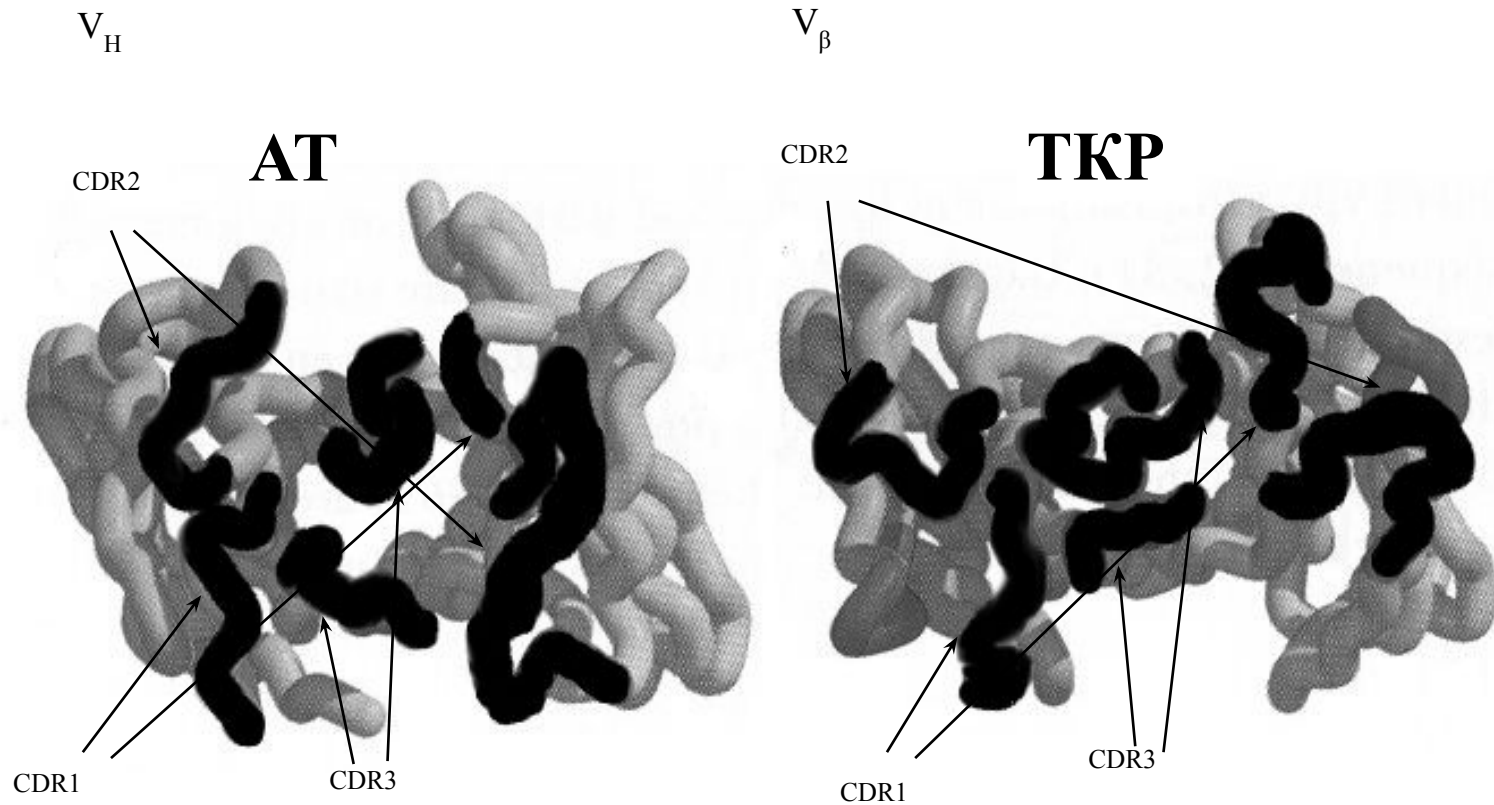

Logic of the RAG immune response

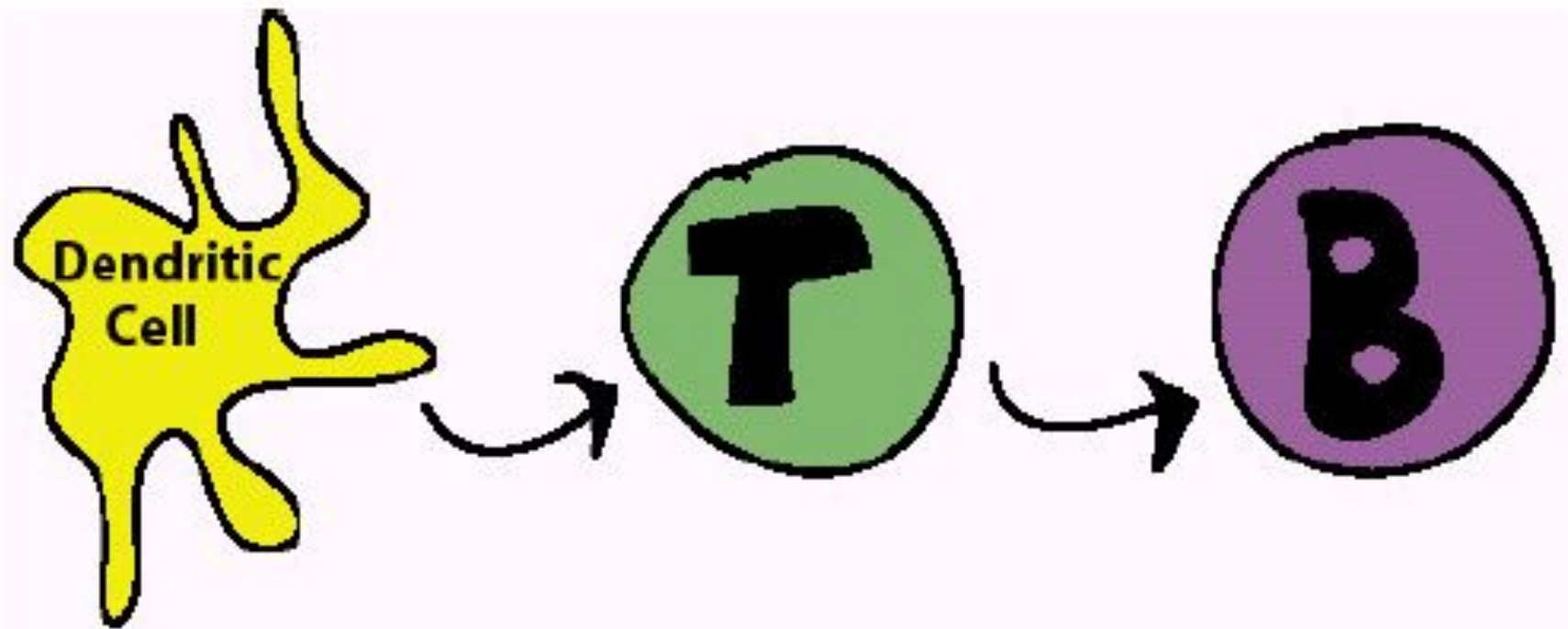

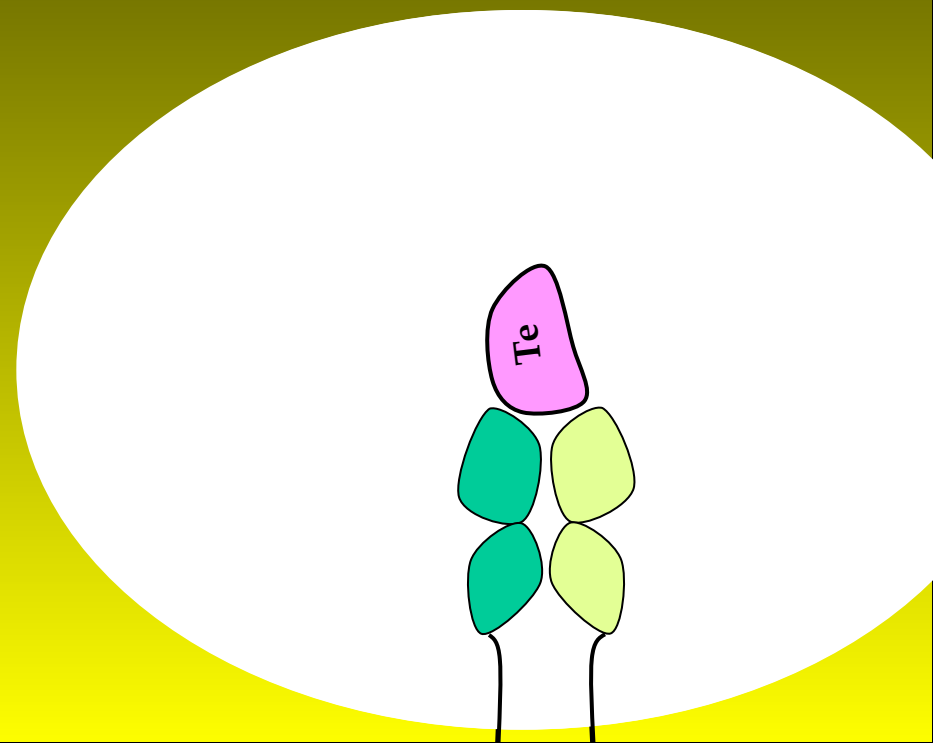
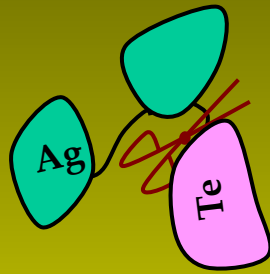
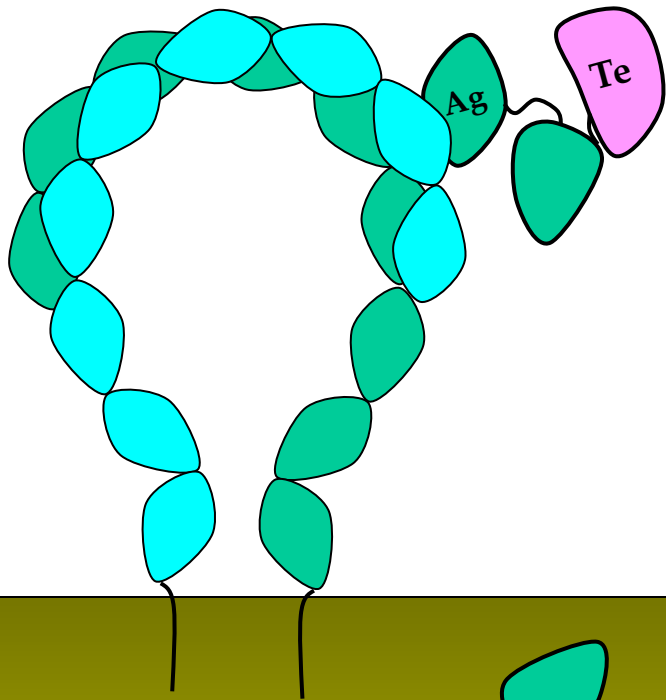

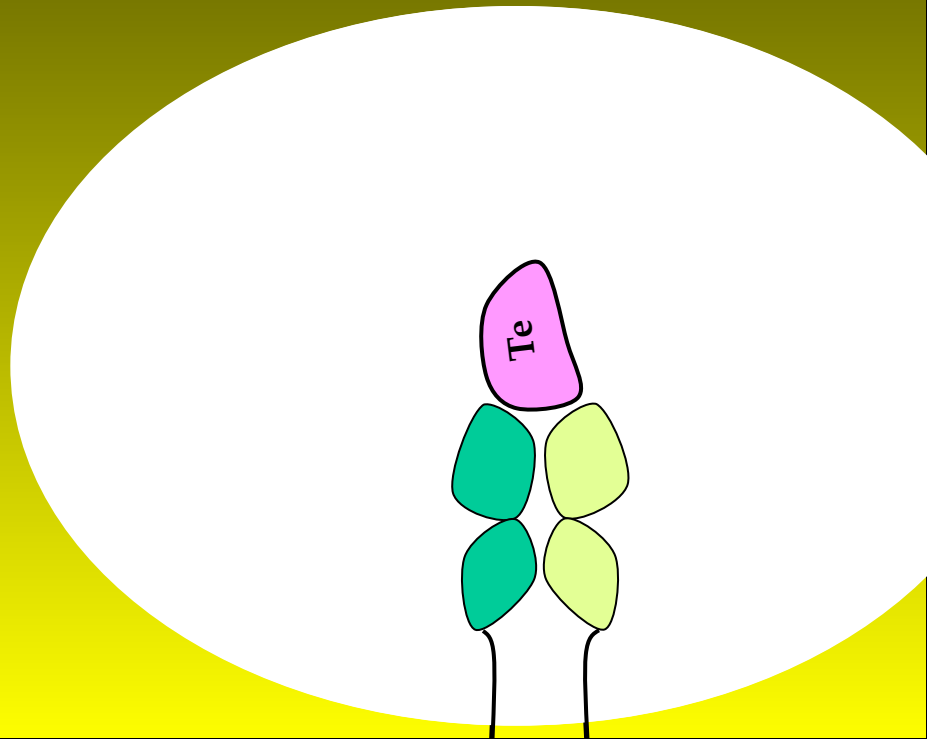
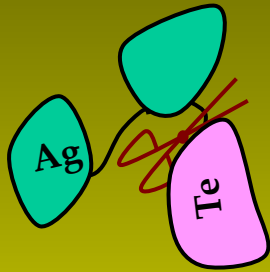
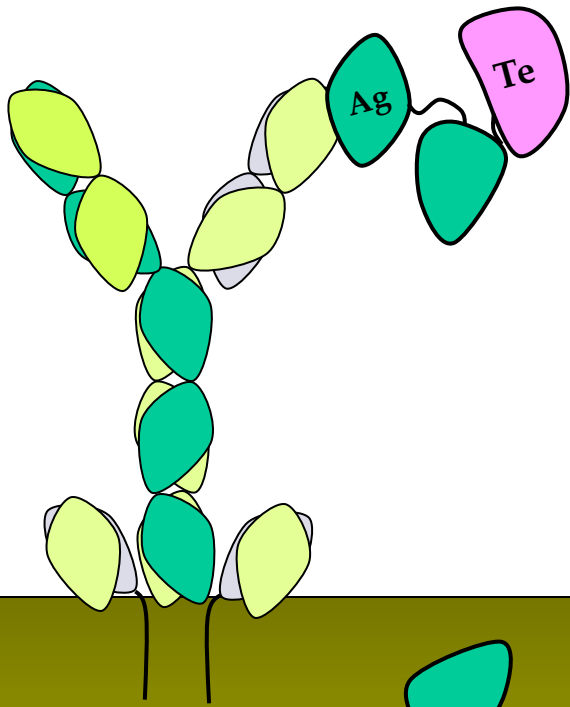

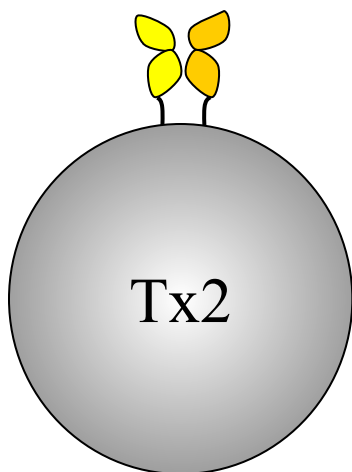
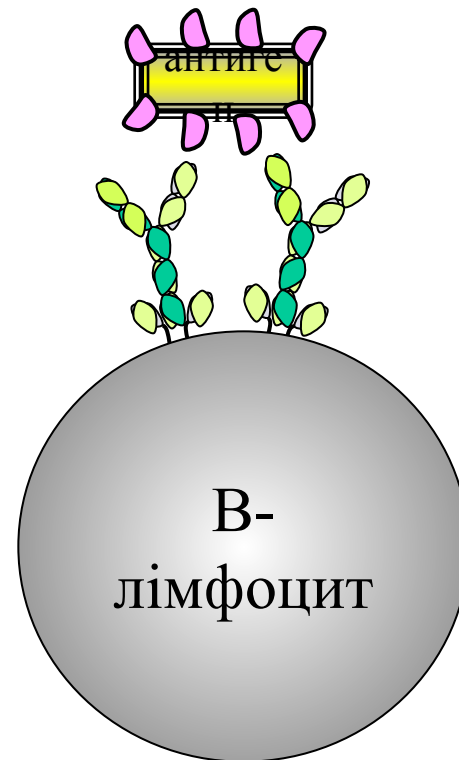
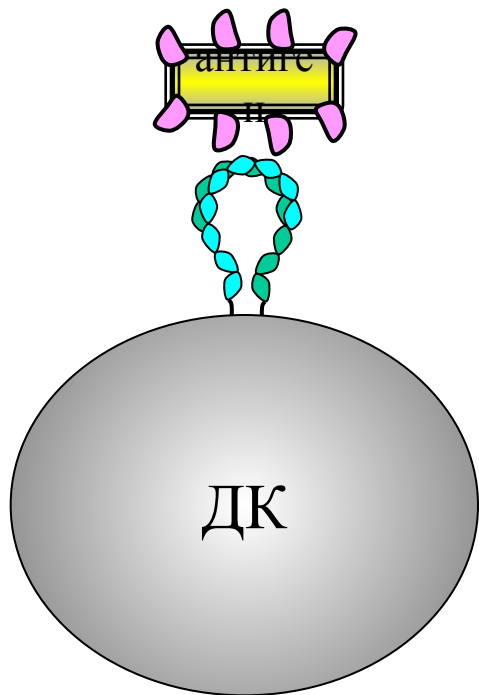

Загальна схема
імуної відповіді

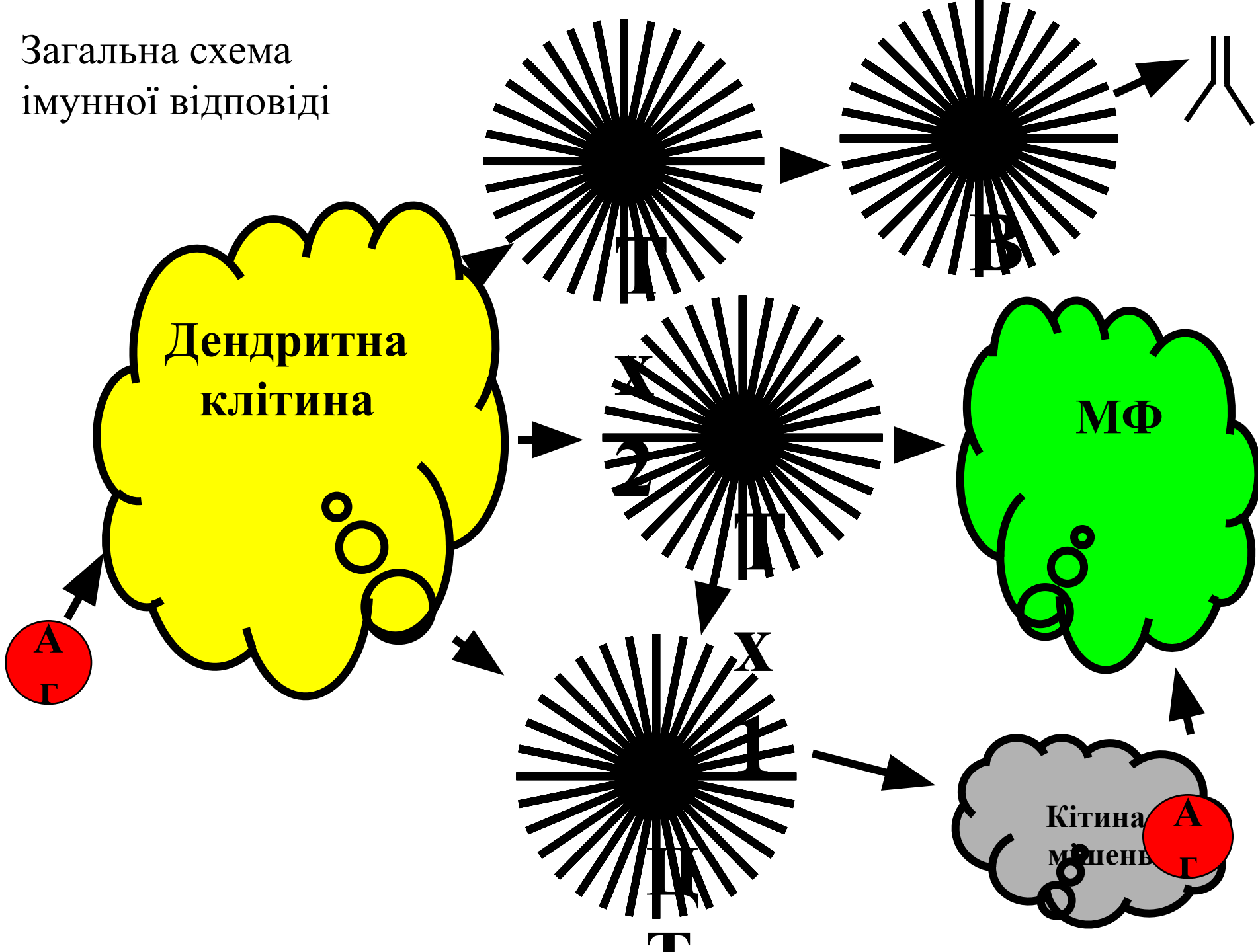

Т-залежна імунна відповідь

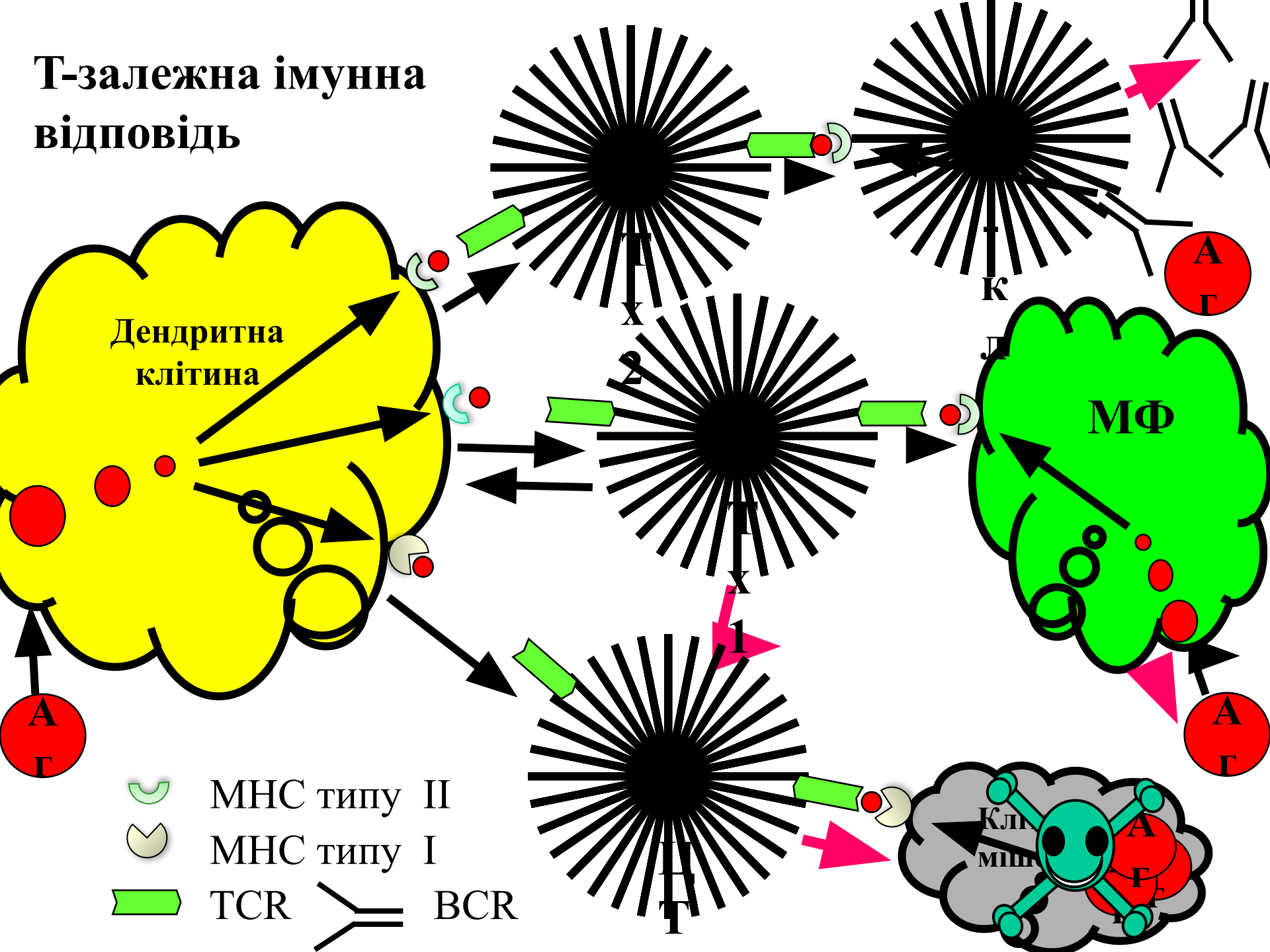

Генетика МНС

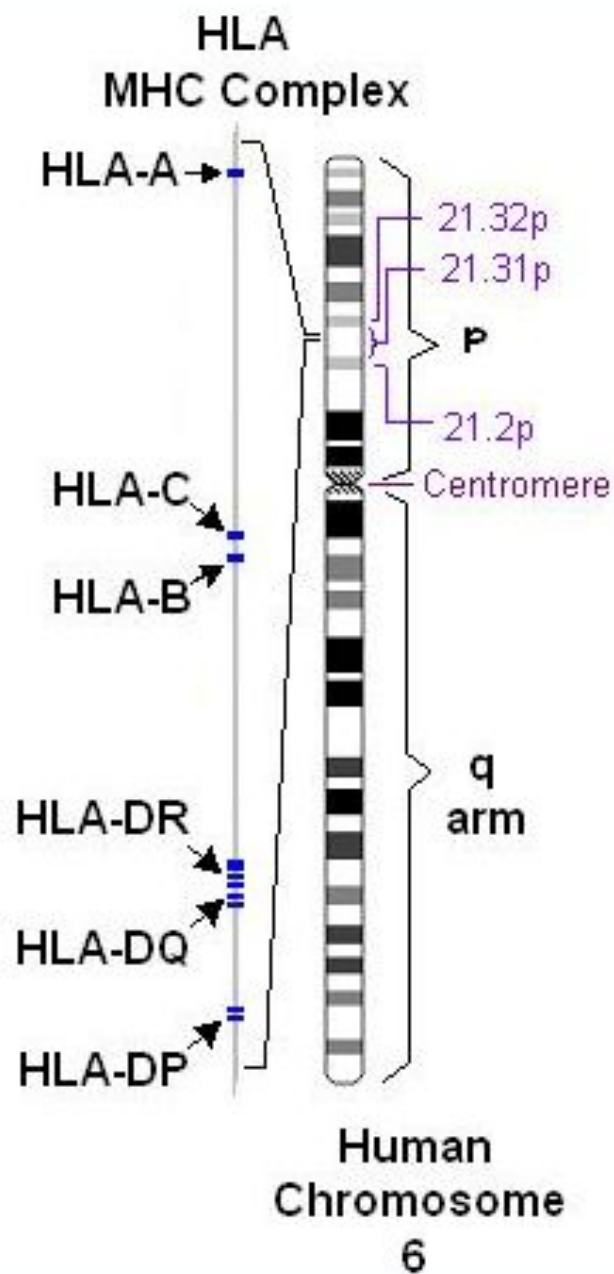

Gene structure of the human MHC

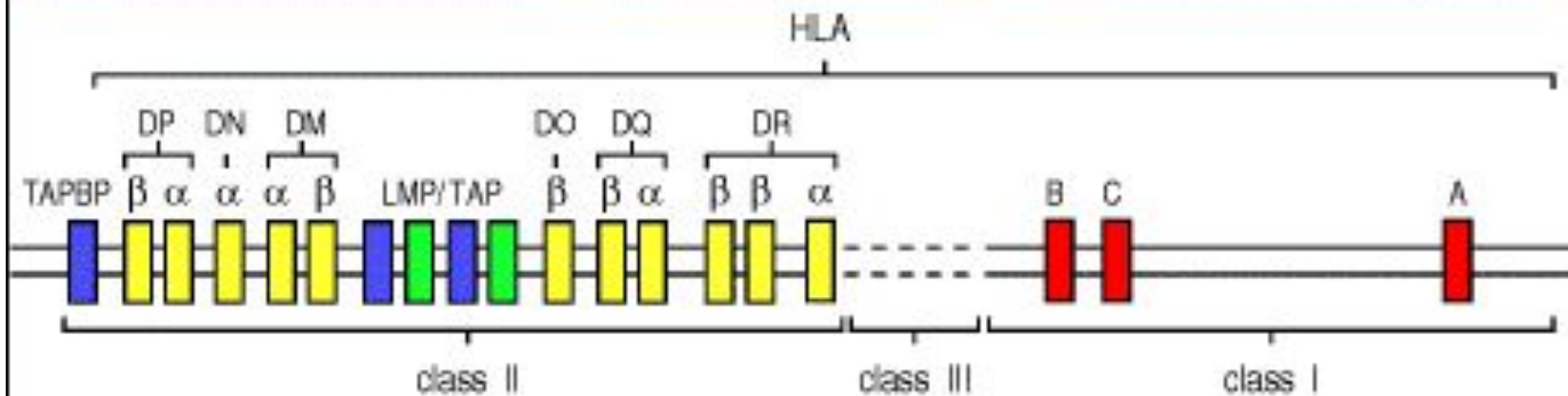

Gene structure of the mouse MHC

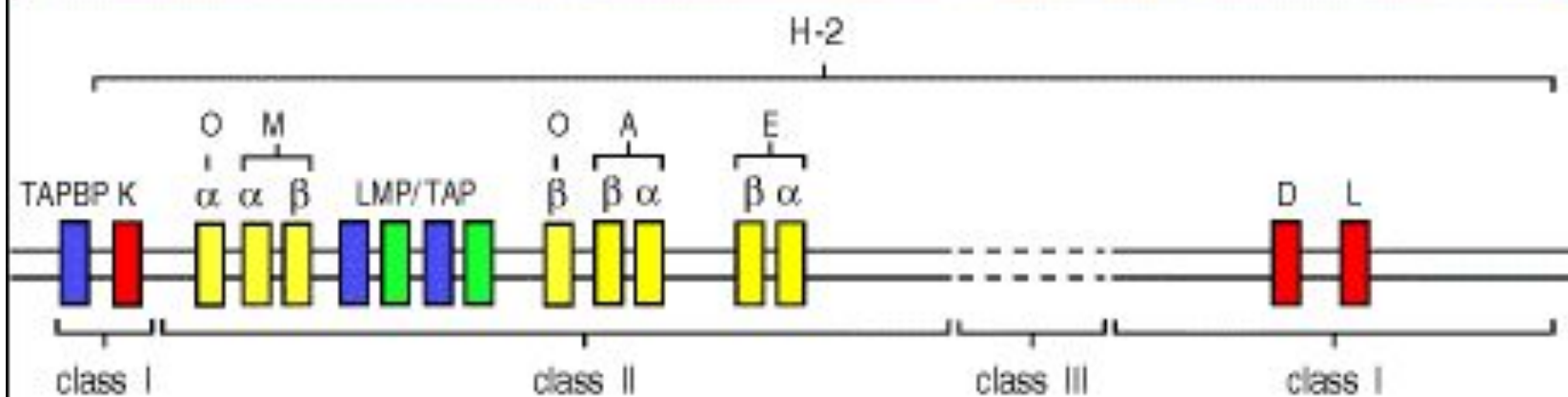

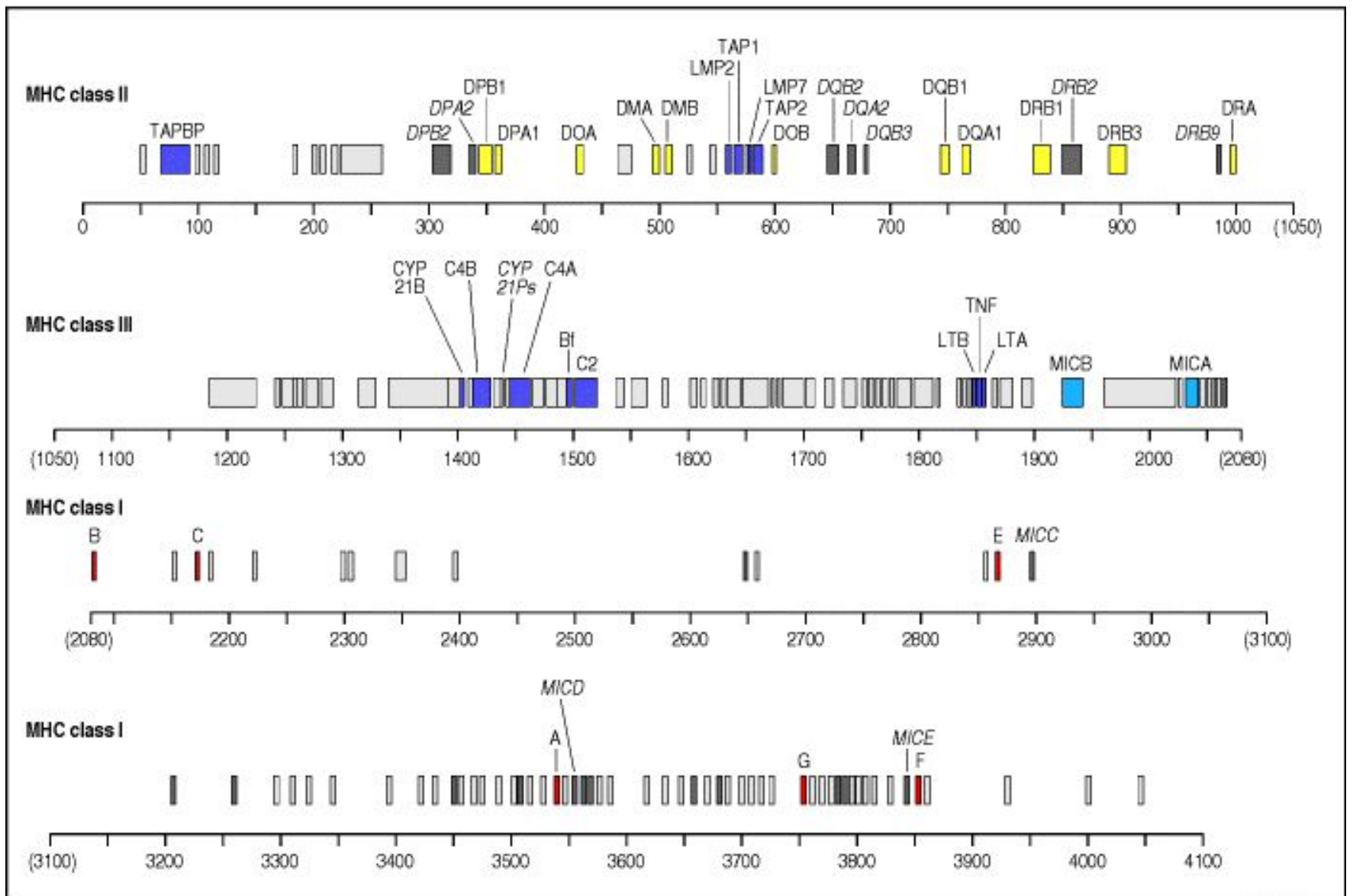

Гени HLA дуже поліморфні

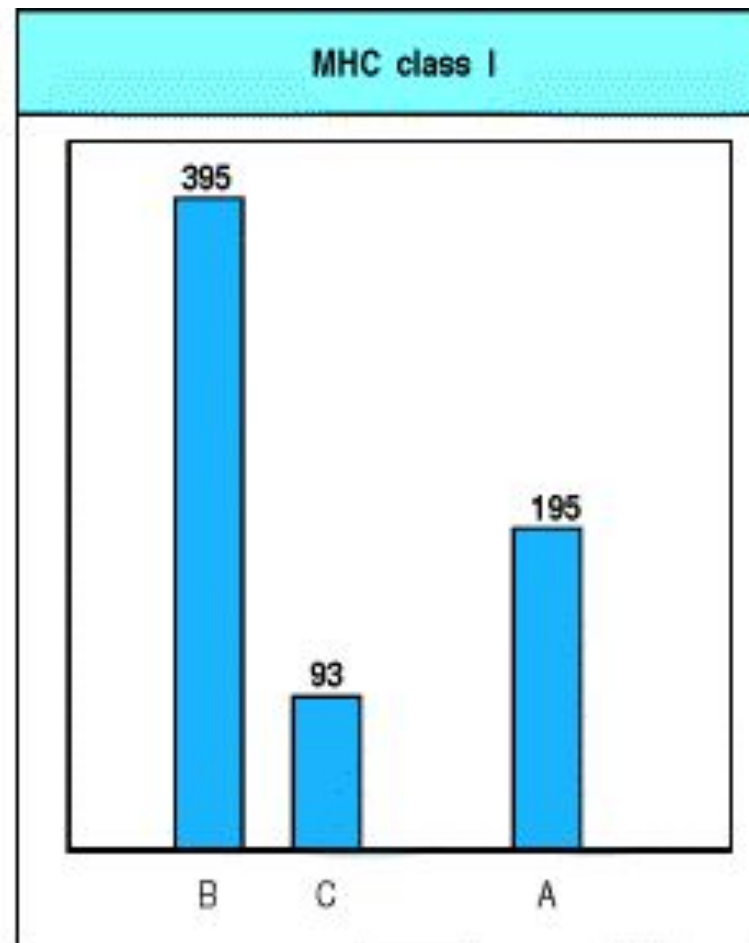
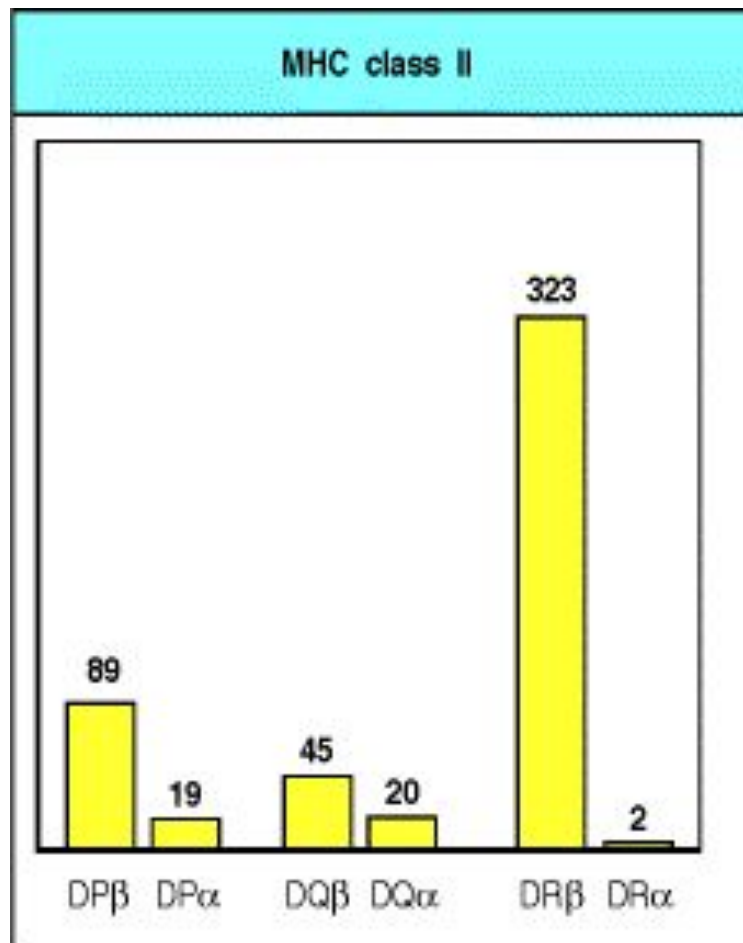

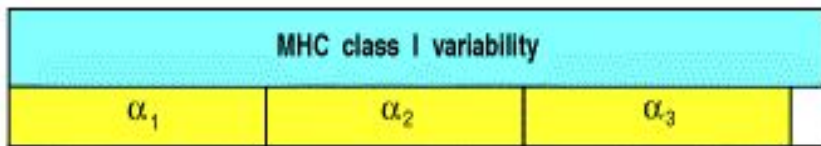
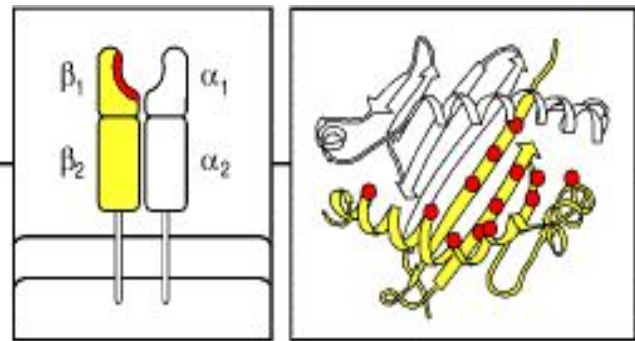
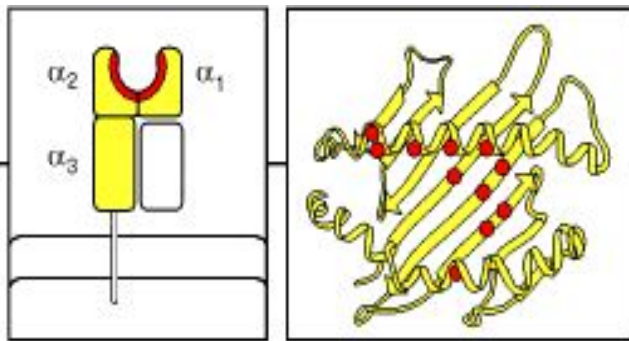

Variability

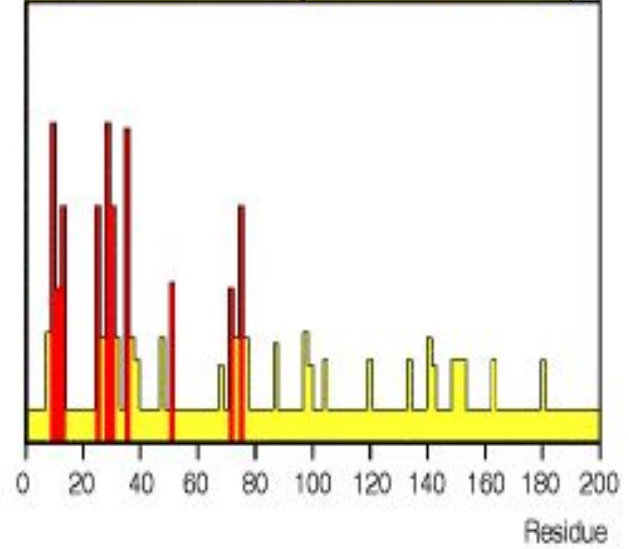
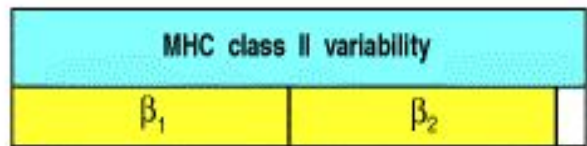
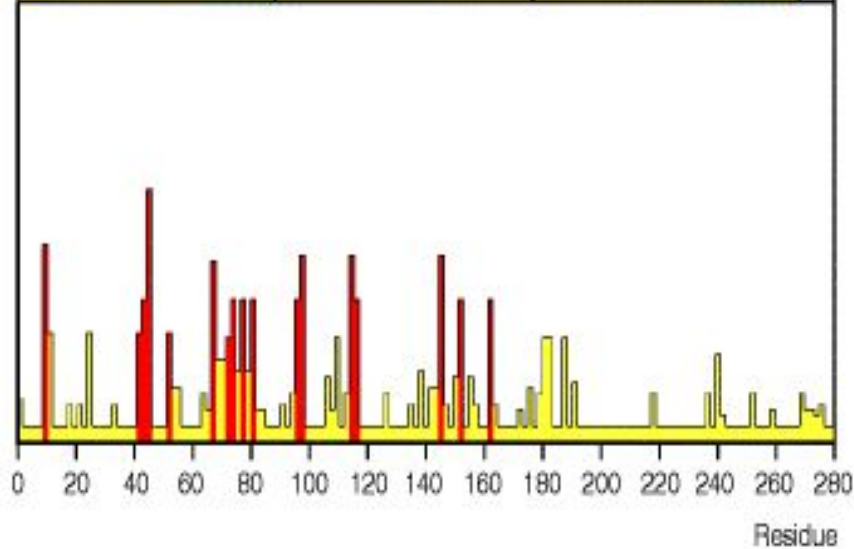

Ще про біологічну роль МНС...



CONTROL OF MATING PREFERENCES IN MICE BY GENES IN THE MAJOR HISTOCOMPATIBILITY COMPLEX*

By K. YAMAZAKI, E. A. BOYSE, V. MIKÉ, H. T. THALER, B. J. MATHIESON,‡
J. ABBOTT, J. BOYSE, Z. A. ZAYAS, AND L. THOMAS

(From the Memorial Sloan-Kettering Cancer Center, New York 10021)

While observing AKR and AKR backcross mice being bred to produce an AKR- $H-2^b$ congenic mouse strain, one of us (J. B.) noticed that homozygous $H-2^b$ ♂♂ were more attracted to heterozygous $H-2^b:H-2^k$ ♀♀ than to $H-2^b$ homozygous ♀♀. Meanwhile another of us (L. T.), unaware of these observations, arrived at the theoretical conclusion that histocompatibility antigens might act as olfactory self-markers distinguishing different members of a population from one another (1).

This article is an account of our study of $H-2$ -associated "mating preference." By " $H-2$ " we imply the chromosomal region including $H-2$ which differentiates congenic stocks from their partner strains. We used a straightforward experimental design: A ♂ mouse (e.g., "bb") was caged with two $H-2$ congenic ♀♀ (e.g., "bb" and "kk"), in estrus, and the trio was observed continuously until the ♂ successfully mated with one of the ♀♀.



First trial

Subsequent trials

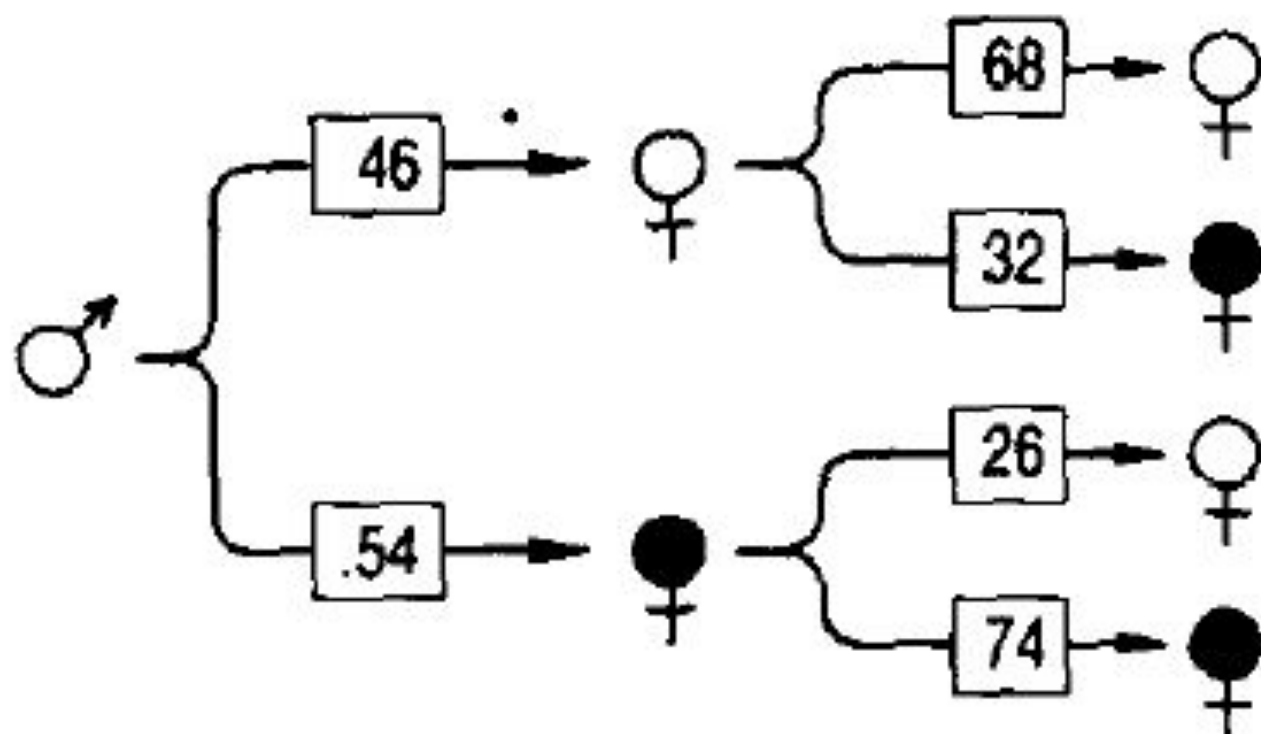

○ dd

● bb

Self Reference

Familial Imprinting

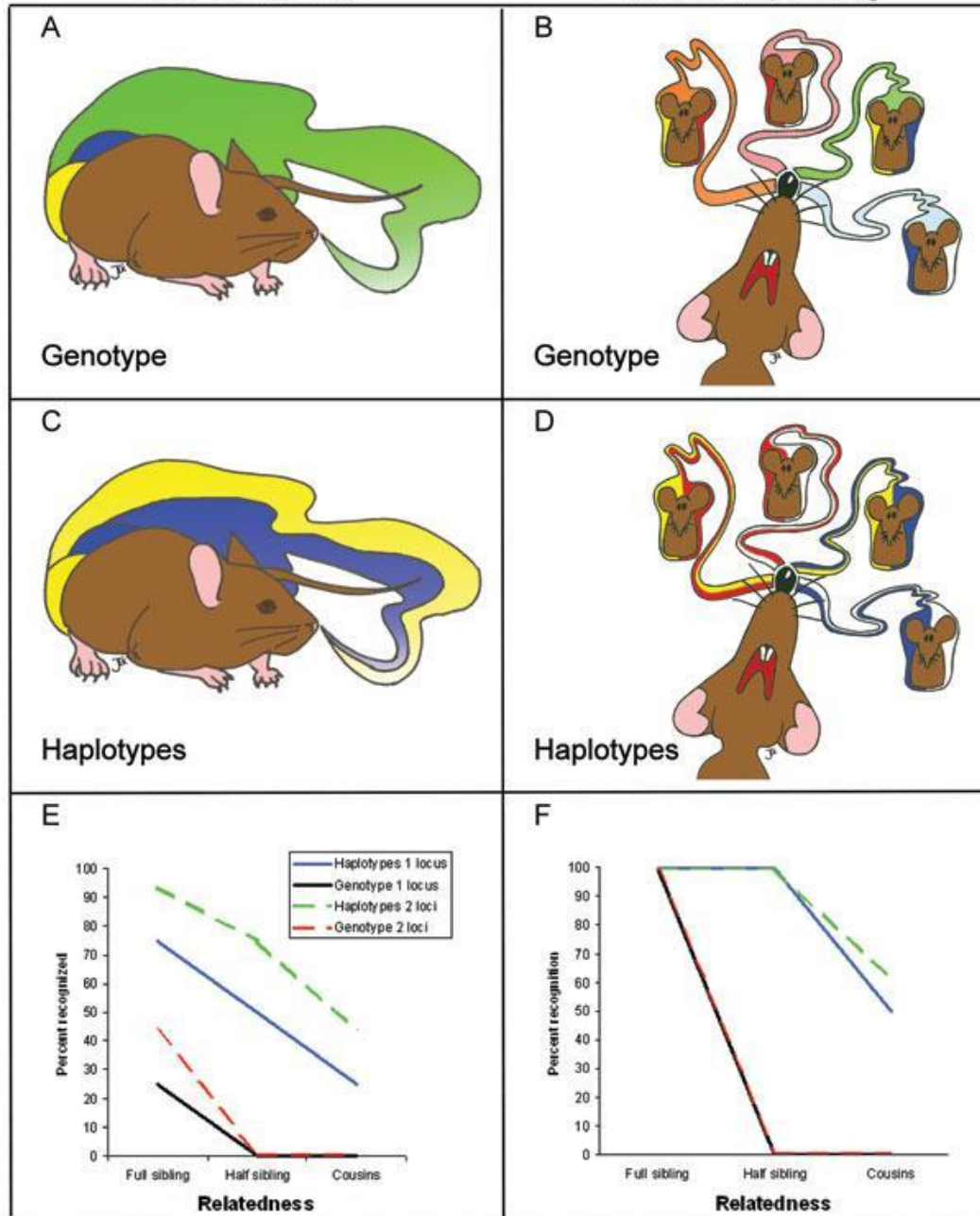

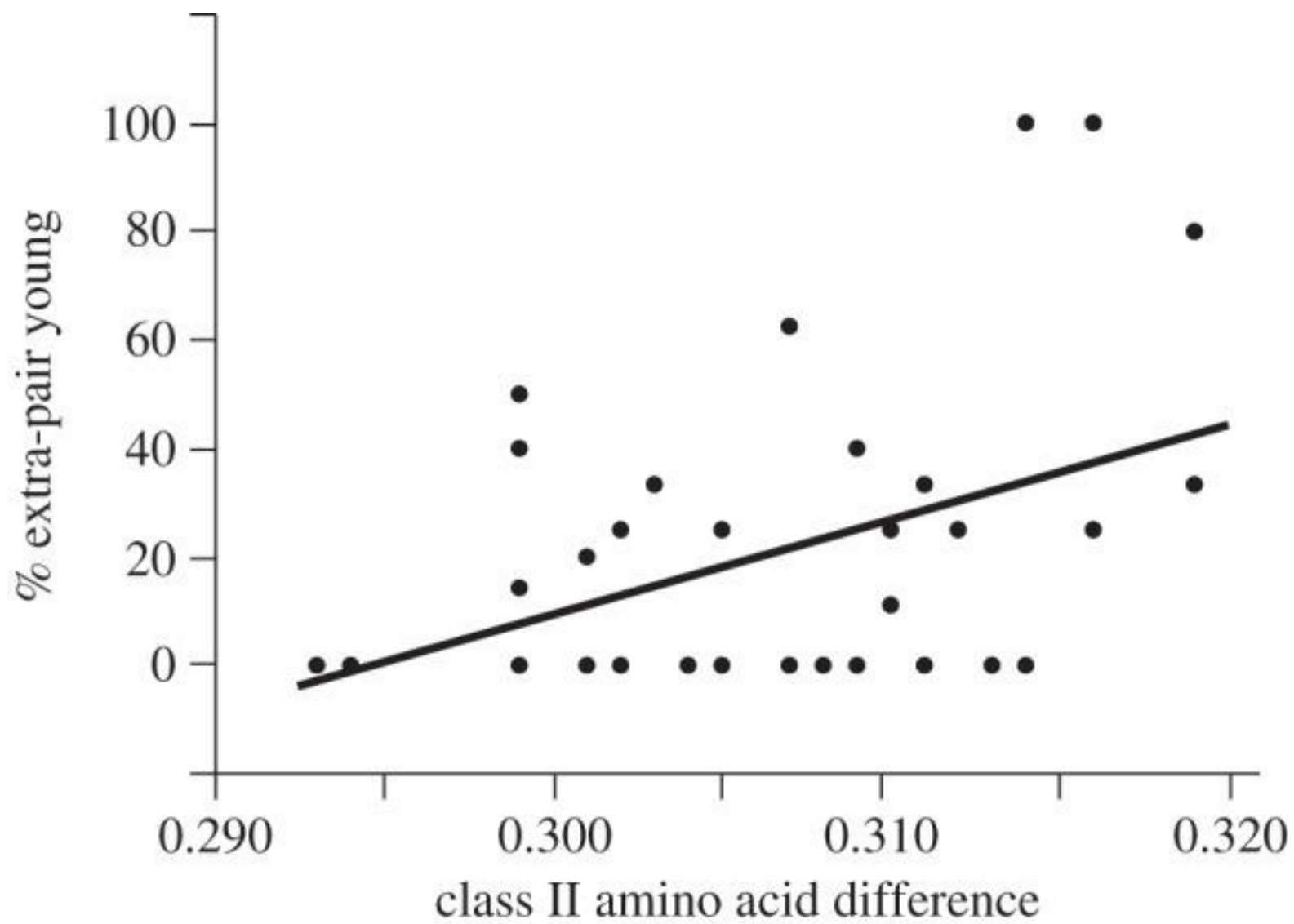



MHC-dependent mate preferences in humans

CLAUS WEDEKIND¹, THOMAS SEEBECK², FLORENCE BETTENS³
AND ALEXANDER J. PAEPKE¹

¹ *Abteilung Verhaltensökologie, Zoologisches Institut, Universität Bern, CH-3032 Hinterkappelen, Switzerland*

² *Institut für Allgemeine Mikrobiologie, Universität Bern, Baltzerstrasse 4, CH-3012 Bern, Switzerland*

³ *Institut für Immunologie und Allergologie, Inselspital Bern, CH-3010 Bern, Switzerland*

SUMMARY

One substantial benefit of sexual reproduction could be that it allows animals (including humans) to react rapidly to a continuously changing environmental selection pressure such as coevolving parasites. This counteraction would be most efficient if the females were able to provide their progeny with certain allele combinations for loci which may be crucial in the parasite-host arms race, for example the MHC (major histocompatibility complex). Here we show that the MHC influences both body odours and body odour preferences in humans, and that the women's preferences depend on their hormonal status. Female and male students were typed for their HLA-A, -B and -DR. Each male student wore a T-shirt for two consecutive nights. The next day, each female student was asked to rate the odours of six T-shirts. They scored male body odours as more pleasant when they differed from the men in their MHC than when they were more similar. This difference in odour assessment was reversed when the women rating the odours were taking oral contraceptives. Furthermore, the odours of MHC-dissimilar men remind the test women more often of their own actual or former mates than do the odours of MHC-similar men. This suggests that the MHC or linked genes influence human mate choice today.



ELSEVIER

Evolution and Human Behavior 26 (2005) 213–226

Evolution
and Human
Behavior

MHC-heterozygosity and human facial attractiveness

S. Craig Roberts^{a,b,*}, Anthony C. Little^b, L. Morris Gosling^a, David I. Perrett^c,
Vaughan Carter^d, Benedict C. Jones^e, Ian Penton-Voak^f, Marion Petrie^a

^a*School of Clinical Medical Sciences, University of Newcastle, Newcastle-upon-Tyne NE1 4HH, UK*

^b*School of Biological Sciences, University of Liverpool, Liverpool L69 7ZB, UK*

^c*School of Psychology, University of St. Andrews, St. Andrews KY16 9JU, UK*

^d*National Blood Service, Holland Drive, Newcastle-upon-Tyne NE2 4NQ, UK*

^e*School of Psychology, University of Aberdeen, Aberdeen AB24 2UB, UK*

^f*Department of Experimental Psychology, University of Bristol, Bristol BS8 1TN, UK*

Initial receipt 1 April 2004; final revision received 9 September 2004



WIKIPEDIA
The Free Encyclopedia

- Main page
- Contents
- Featured content
- Current events
- Random article
- Donate to Wikipedia
- Wikimedia Shop

- Interaction
 - Help
 - About Wikipedia
 - Community portal
 - Recent changes
 - Contact page

- Tools

- Print/export

- Languages
 - Edit links

Create account Log in

Article Talk

Read Edit View history

Search



Wiki Loves Earth photo contest:
Upload photos of Ukraine's natural heritage sites to help Wikipedia and win fantastic prizes!



Major histocompatibility complex and sexual selection

From Wikipedia, the free encyclopedia

A pathogen is any agent that causes disease. The body has two defense mechanisms for dealing with pathogenic microorganisms and other harmful substances: the inflammatory reaction and the development of an acquired immunity. Acquired immunity consists of humoral or cell-mediated immunity, and develops after initial contact with a pathogen; it is manifested by the ability of one's immune system to fight foreign antigens.^[1]

All living cells have structures called antigens present on their cell surface. Antigens are either a polysaccharide or a protein that reacts specifically with a cell surface receptor or an antibody. For each person and each type of cell there are different antigens on the cell's surface. The unique, genetically-determined antigens present on cell surfaces are determined by a cluster of genes on chromosome 6 at loci 6p21.3 called the **major histocompatibility complex (MHC)**.^[2] In humans, these antigens were first identified on a type of white blood cell (leukocyte) and were therefore named human leukocyte antigens (HLA antigens). As a result, the human major histocompatibility complex can also be called the HLA system. Often in reference to these antigens and the set of genes responsible for these antigens the terms MHC and HLA are used interchangeably.^[1]

The antigens on cell surfaces are processed by the cells of the body's immune system depending on their antigenicity. Specifically, the antigenicity of the HLA surface proteins depends on whether they are one's own proteins (self-antigens) or whether they are the foreign proteins of another person (non-self-antigens). The HLA proteins on a person's own cells are recognized by their immune system as such, while non-self-antigens will incite an immune response. Originally, MHC proteins were considered of interest only in regards to organ transplantation because transplants in which the donor and recipient cells contained different MHC proteins resulted in organ rejection unless the immune system was suppressed. Further studies have shown MHC to actually have a much larger role in the immune system than just organ transplantation. The MHC region of genes contains extremely high levels of gene density and diversity; genetic variation within this region plays a vital role in susceptibility to autoimmune, infectious, and other diseases.^[2] MHC genes are also involved in various non-immune functions such as olfaction^[2] and self/non-self-recognition.^{[1][3]}

Contents [hide]

- 1 MHC Class I, II, and III proteins
- 2 MHC evolution and allelic diversity
- 3 MHC and sexual selection
 - 3.1 The relationship between olfaction and MHC
 - 3.2 MHC-mediated mate choice: case studies
 - 3.3 MHC and sexual conflict
- 4 See also
- 5 References

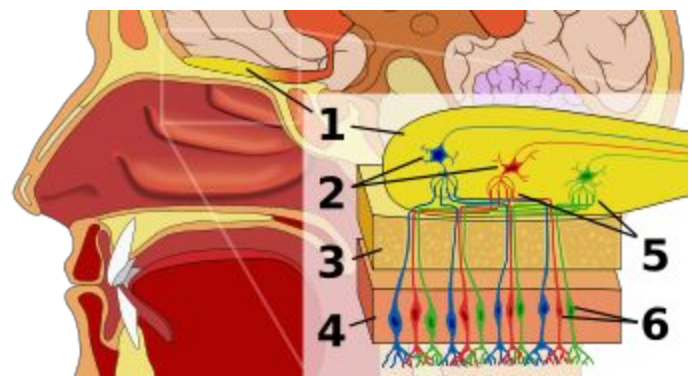

MHC Class I, II, and III proteins [edit]

