



Архитектурные методы в археологии







Чертёж – это анализ!





1-я известковая линза

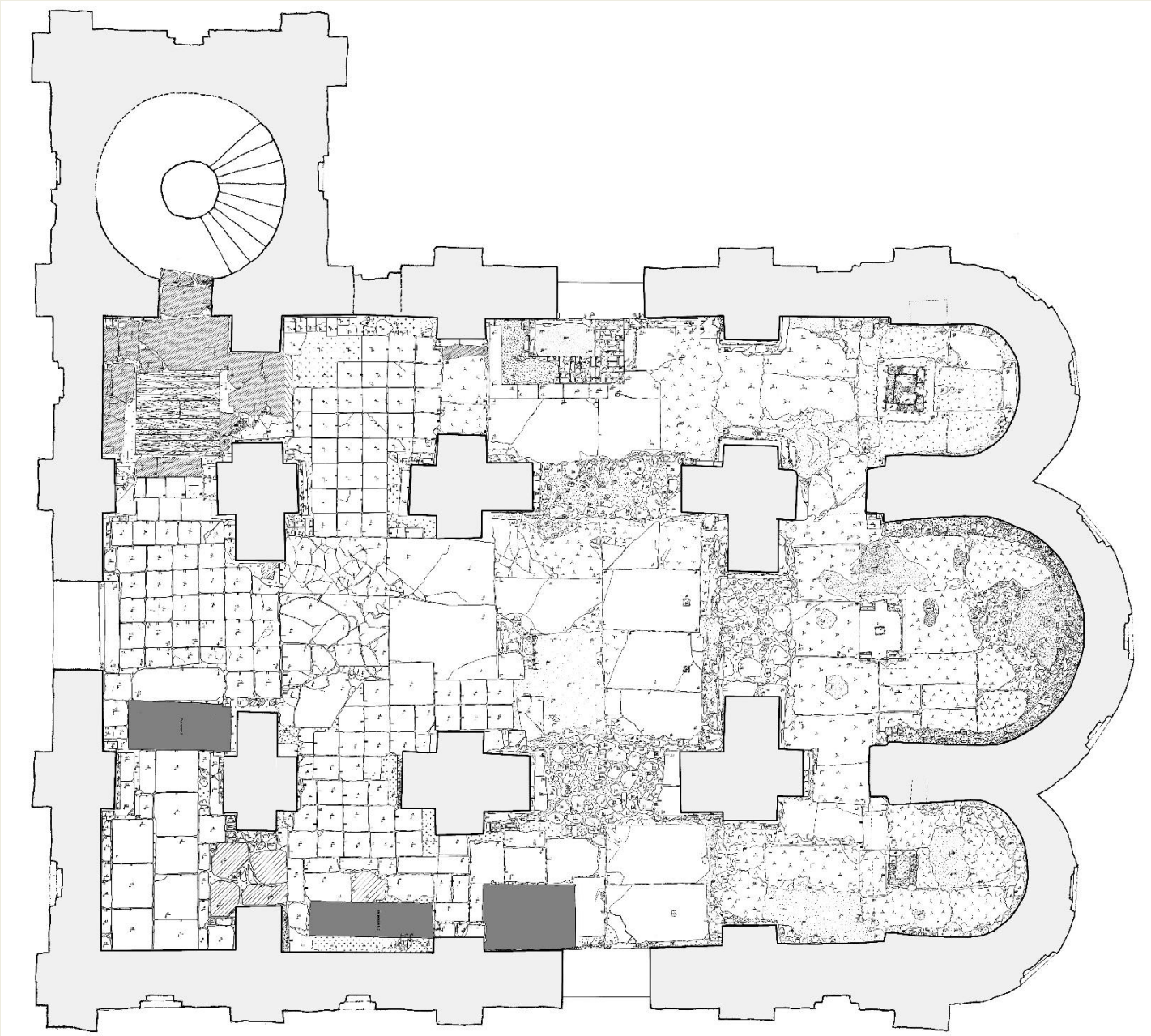
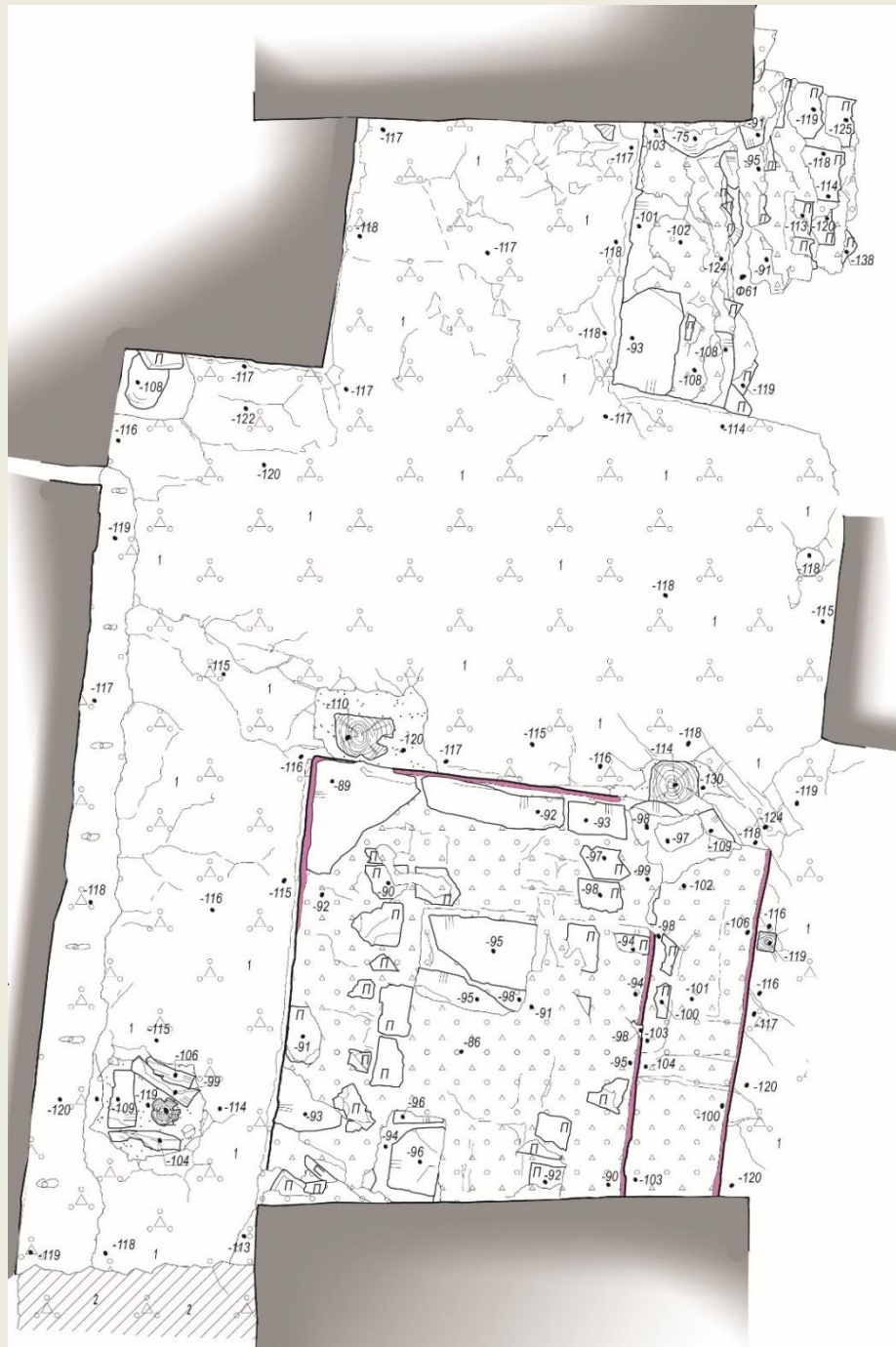
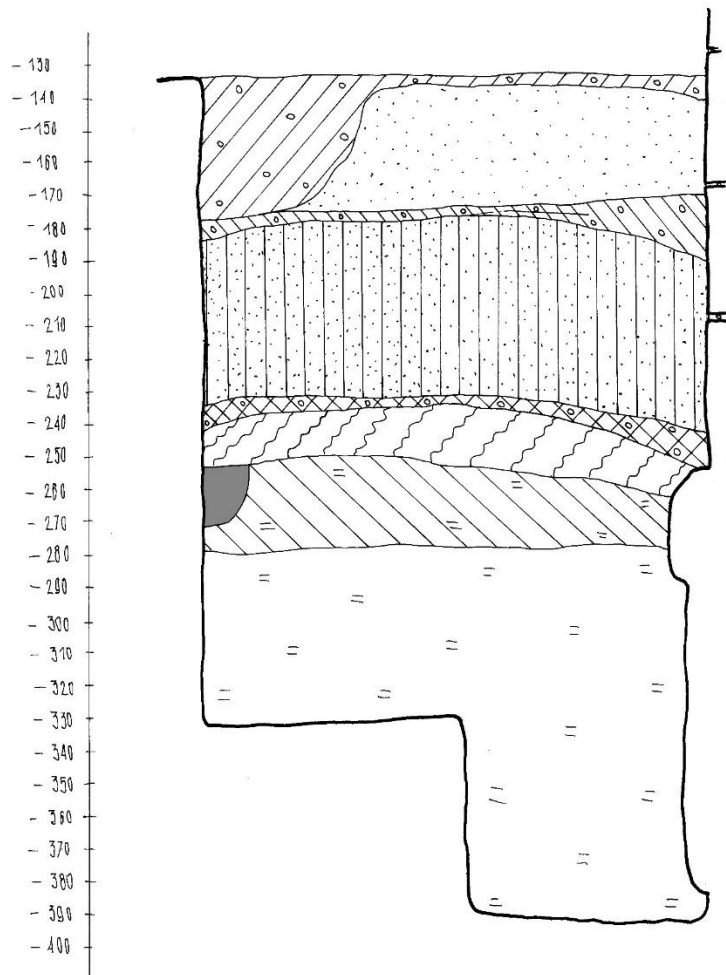
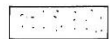

1-й песок

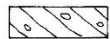

2-я известковая линза



2-й песок



3-я известковая линза

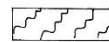

гумусированный слой

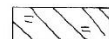

коричневый гумусированный слой

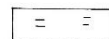

предматерик



ленточный фундамент

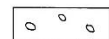

известковый раствор

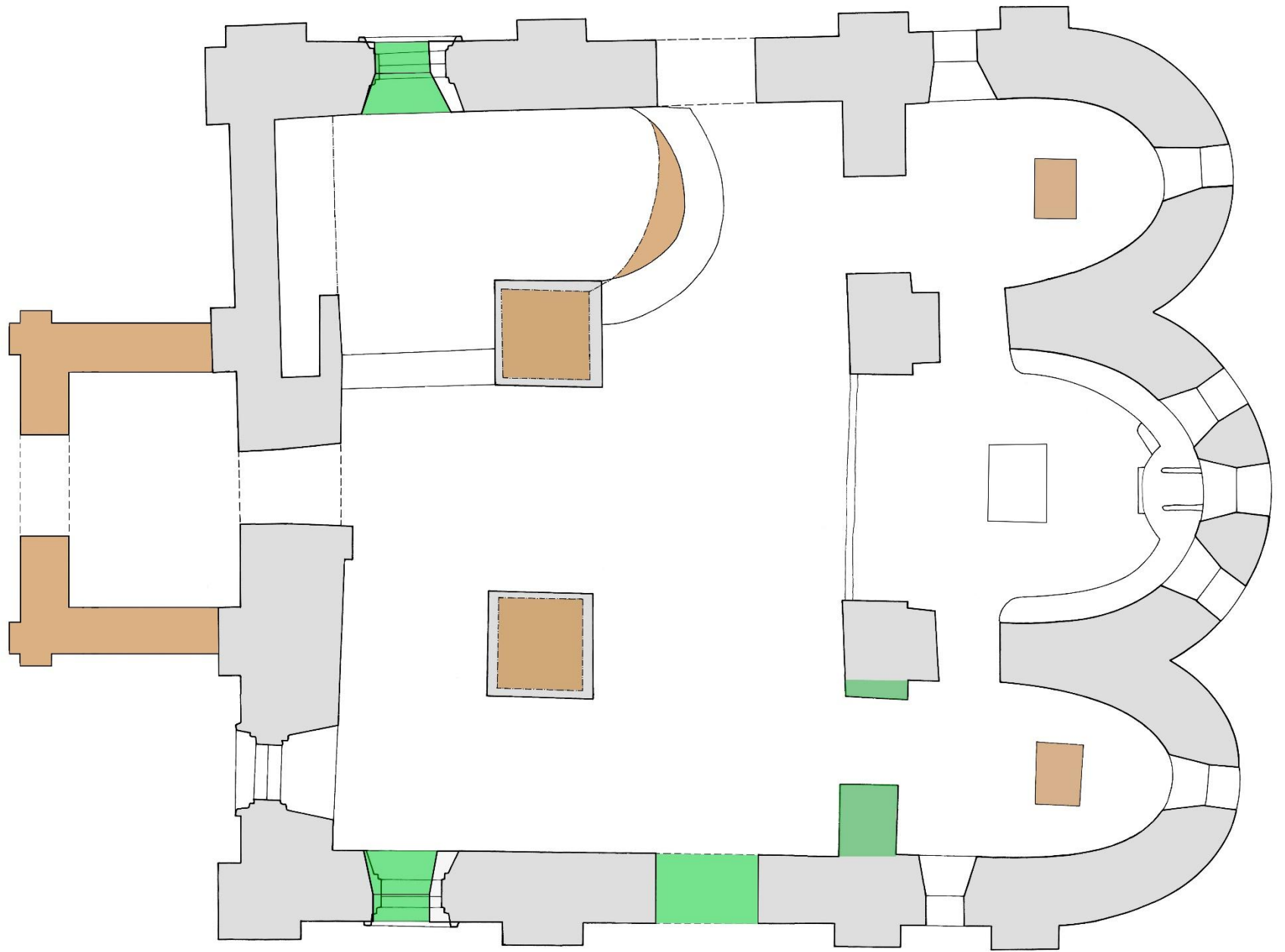

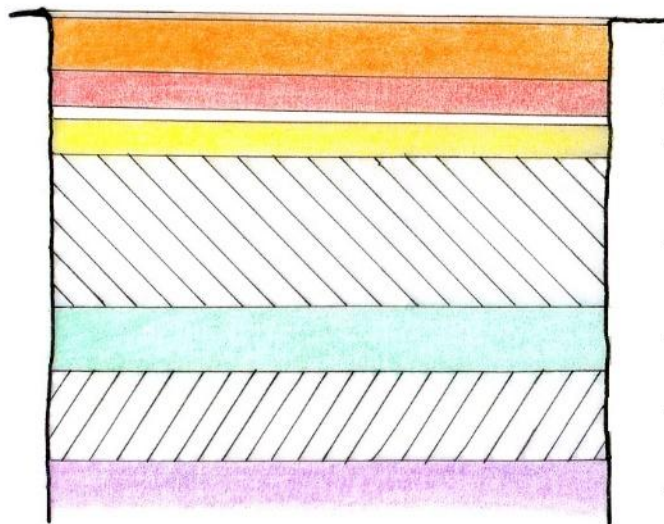
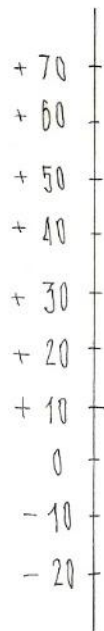

- чугунный
- 1-й кирпичный
- 2-й кирпичный
- уровень плит у Феоктиста
- слой строительного мусора с фресками
- плитяной
- слой строительного мусора с фресками
- наливной пол XII в.



Виды чертежей:

- полевые
- чистовые (домашние)
- аналитические

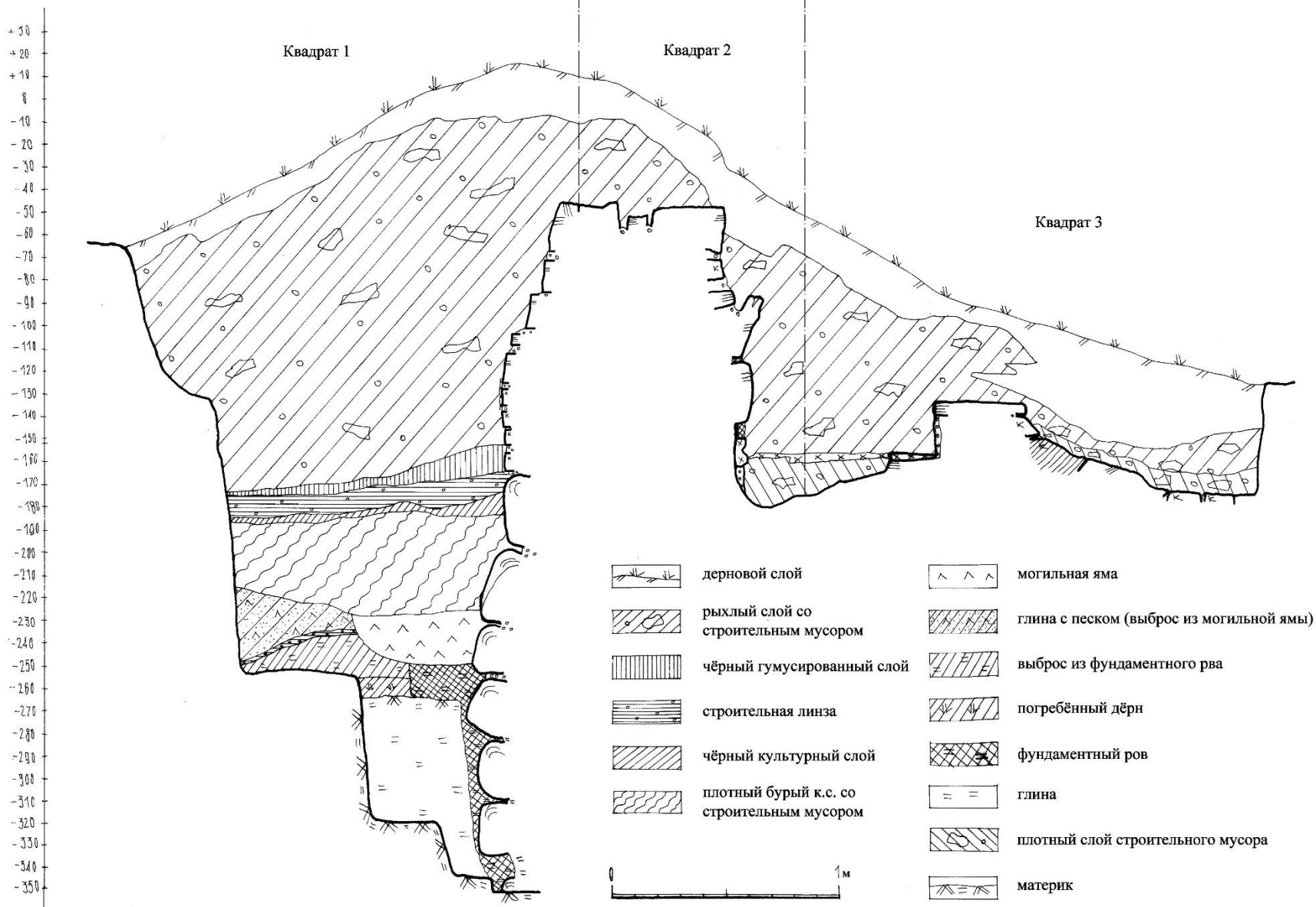

Виды чертежей:

- план
- фасад
- разрез/сечение
- аксонометрия



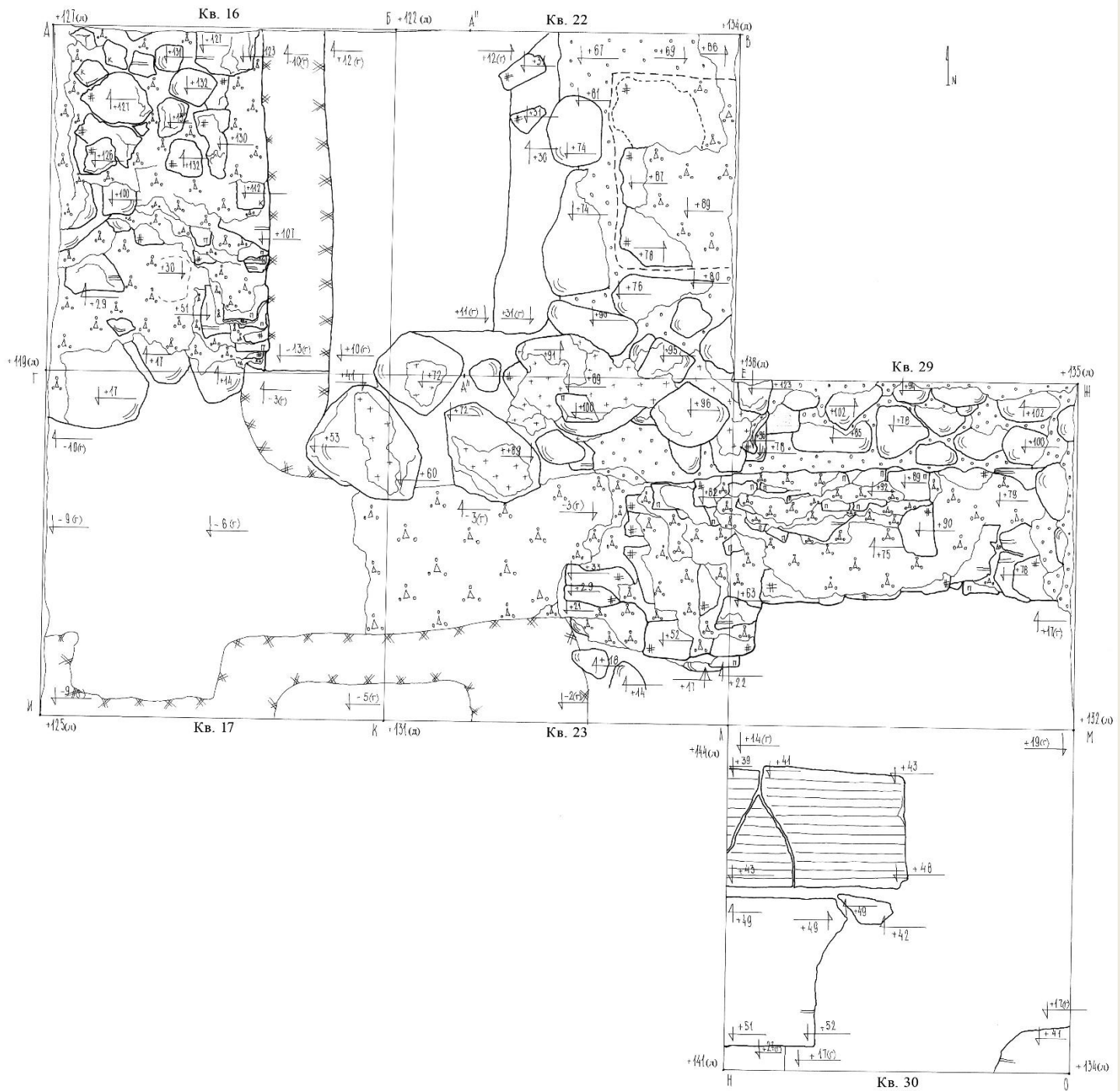

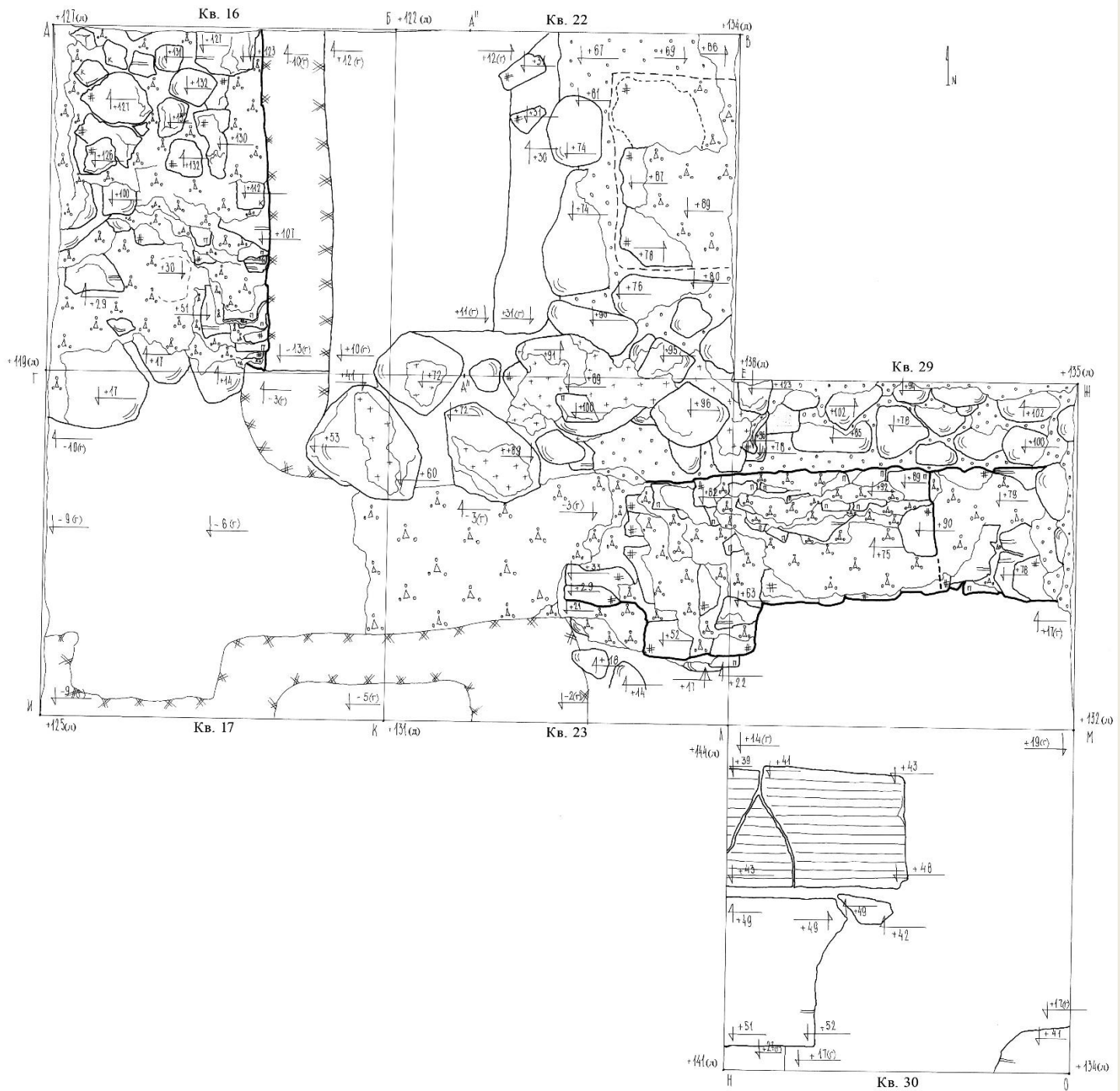

Нивелирование –
определение ВЫСОТЫ

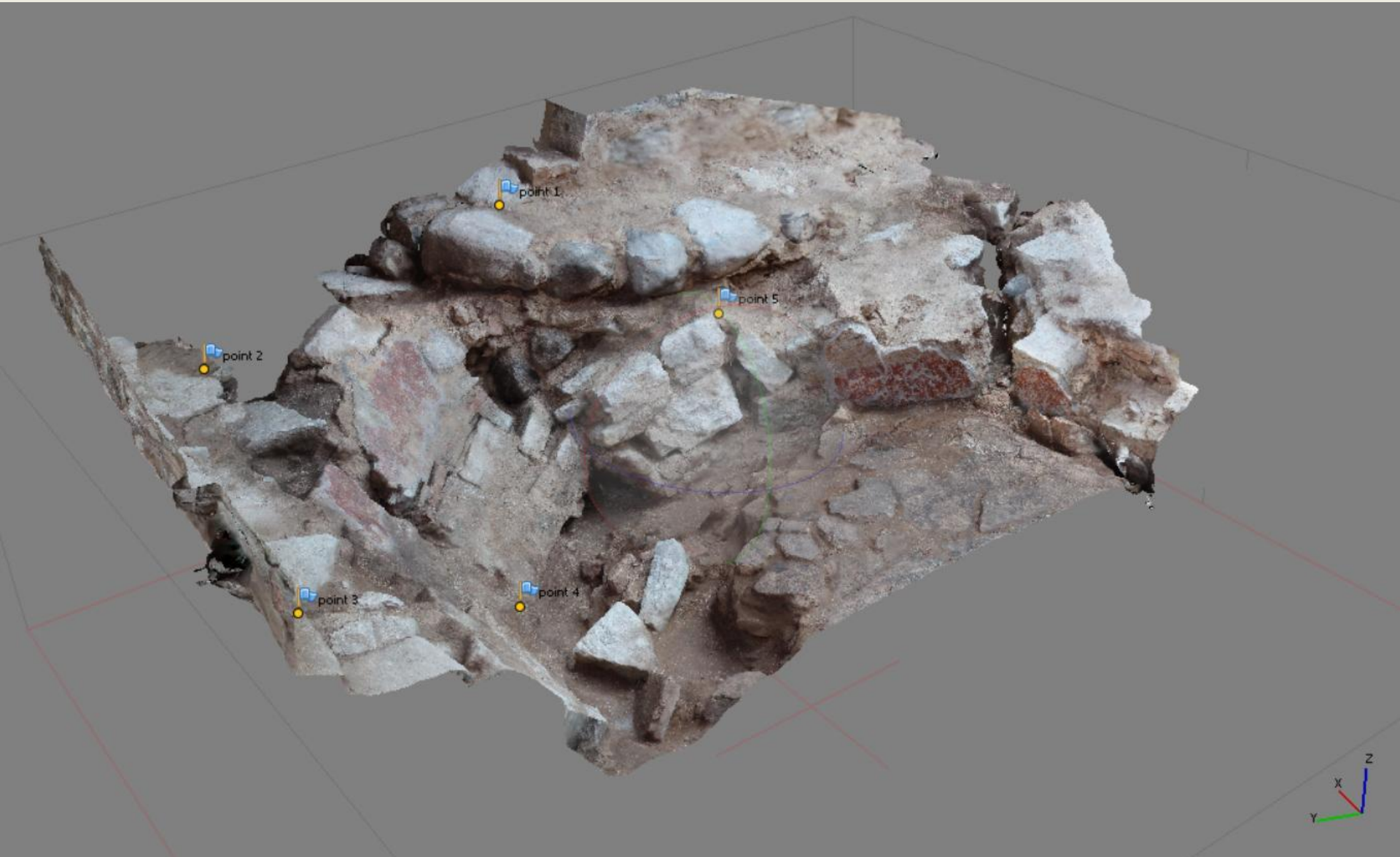



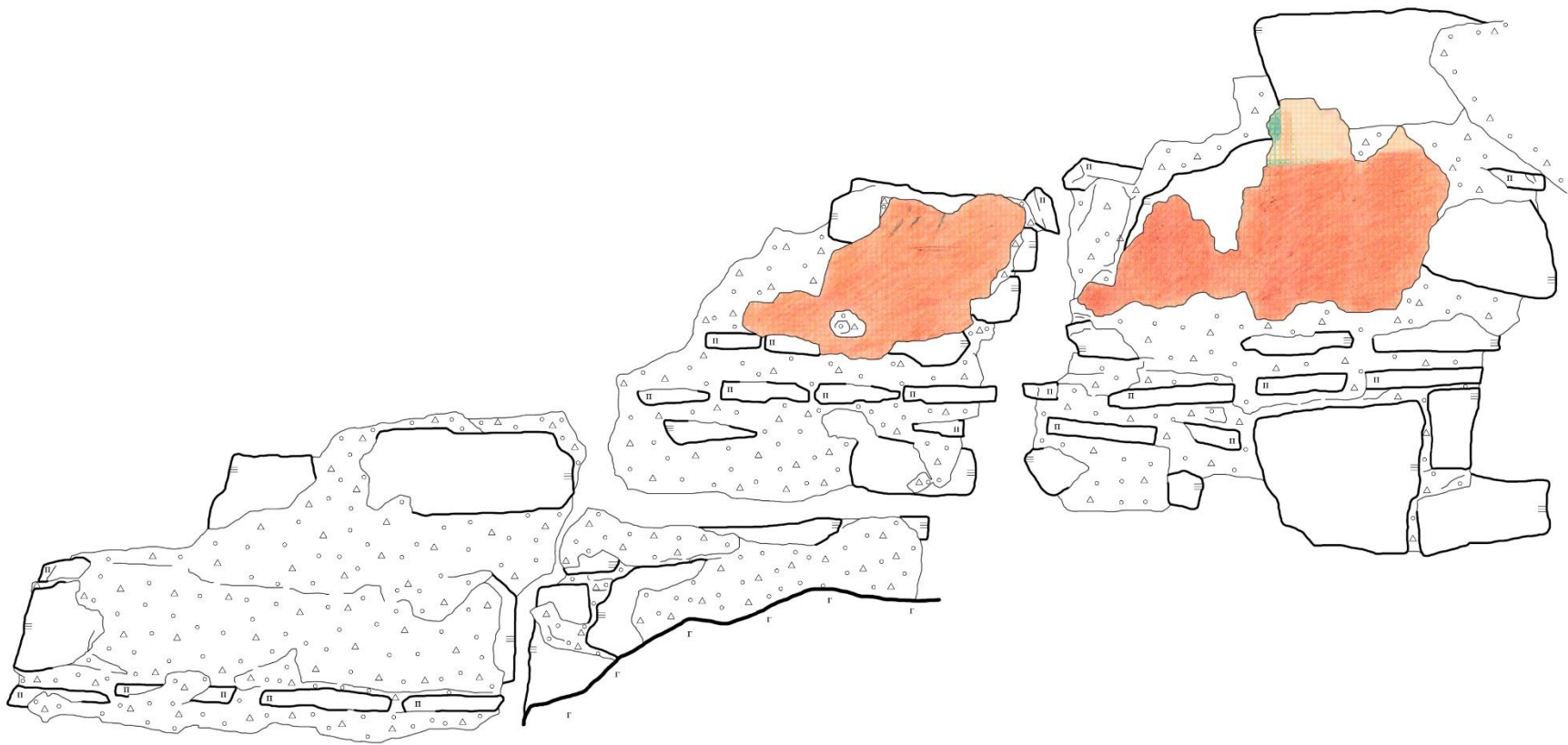



План

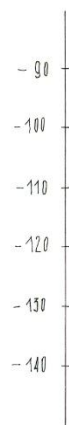
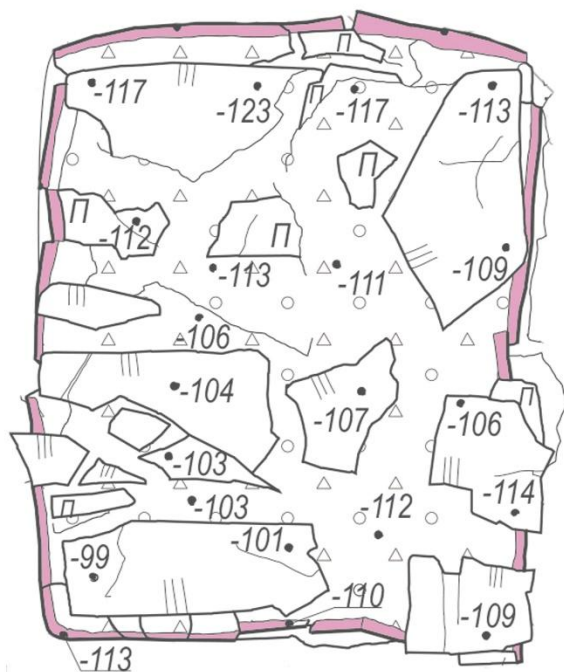

Западный фасад

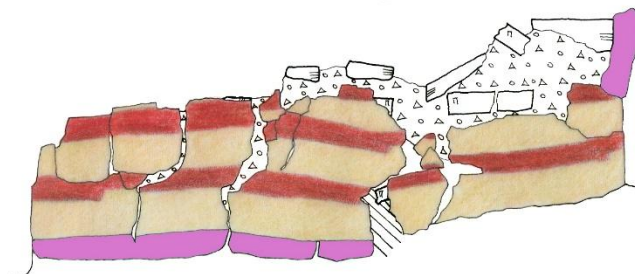

Северный фасад

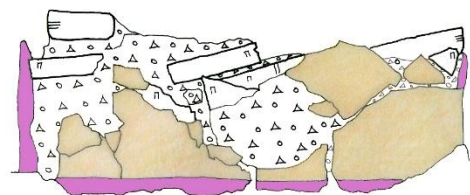

Восточный фасад

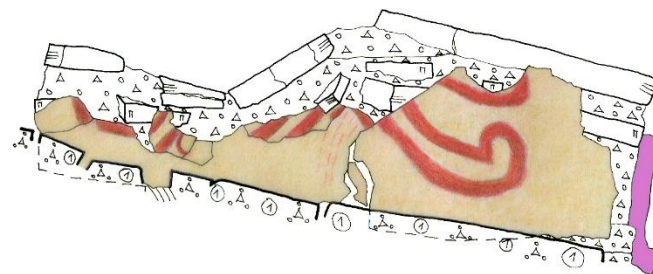

0
- 10
- 20
- 30
- 40
- 50
- 60
- 70
- 80
- 90
- 100
- 110
- 120
- 130
- 140
- 150
- 160
- 170
- 180
- 190
- 200
- 210
- 220
- 230
- 240
- 250
- 260
- 270
- 280
- 290
- 300
- 310
- 320
- 330
- 340
- 350
- 360

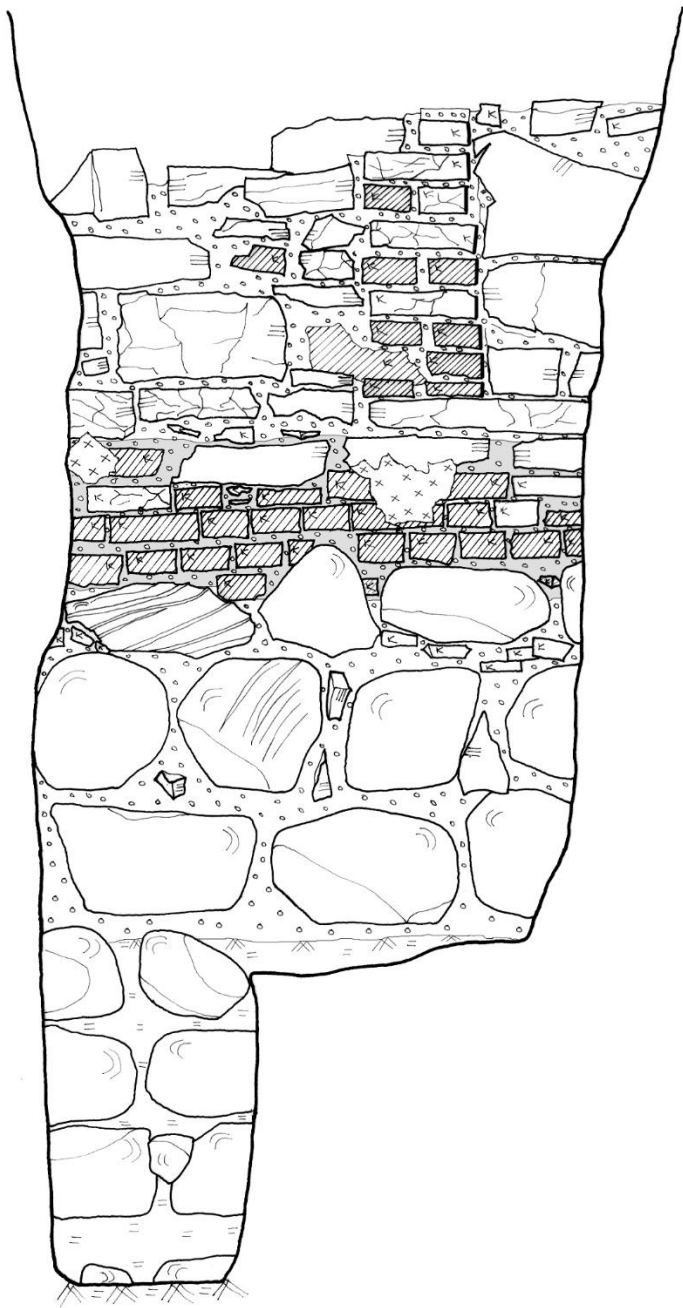

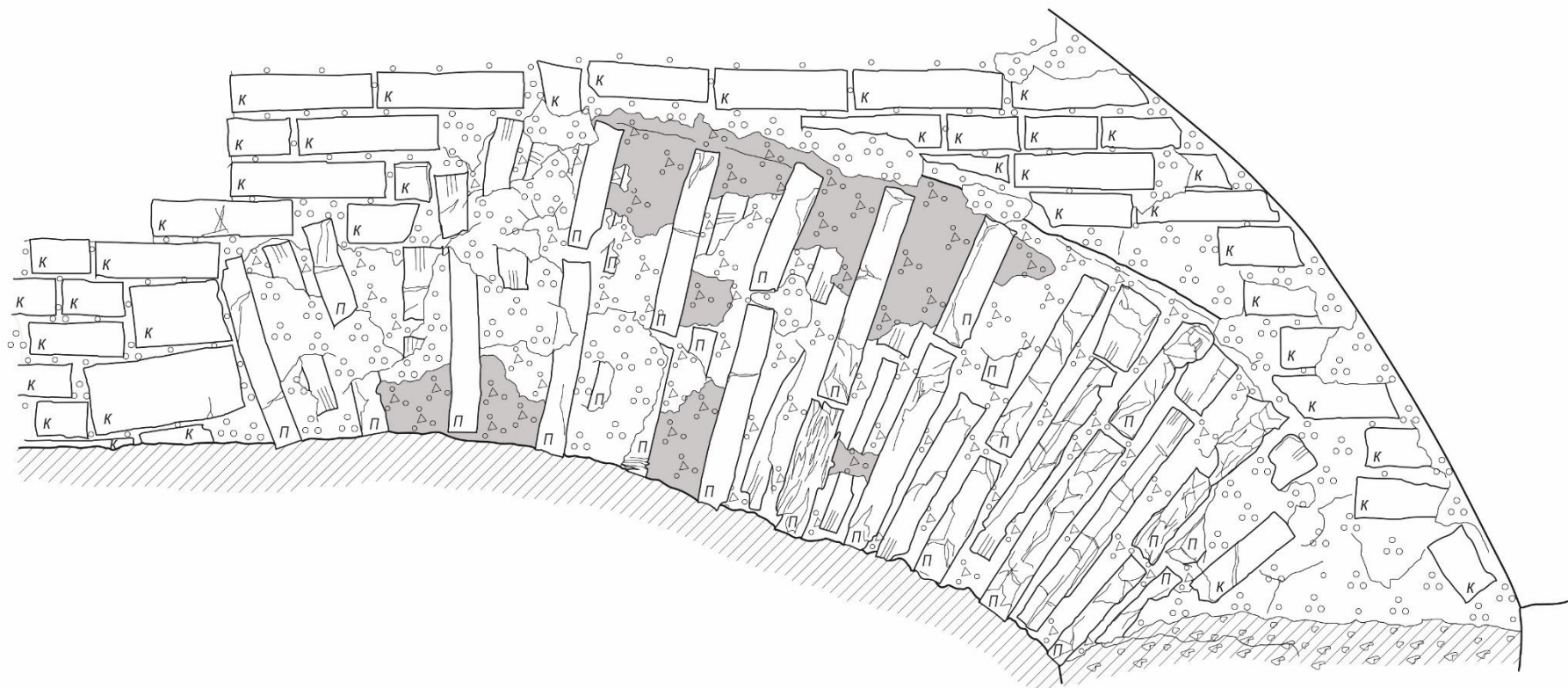

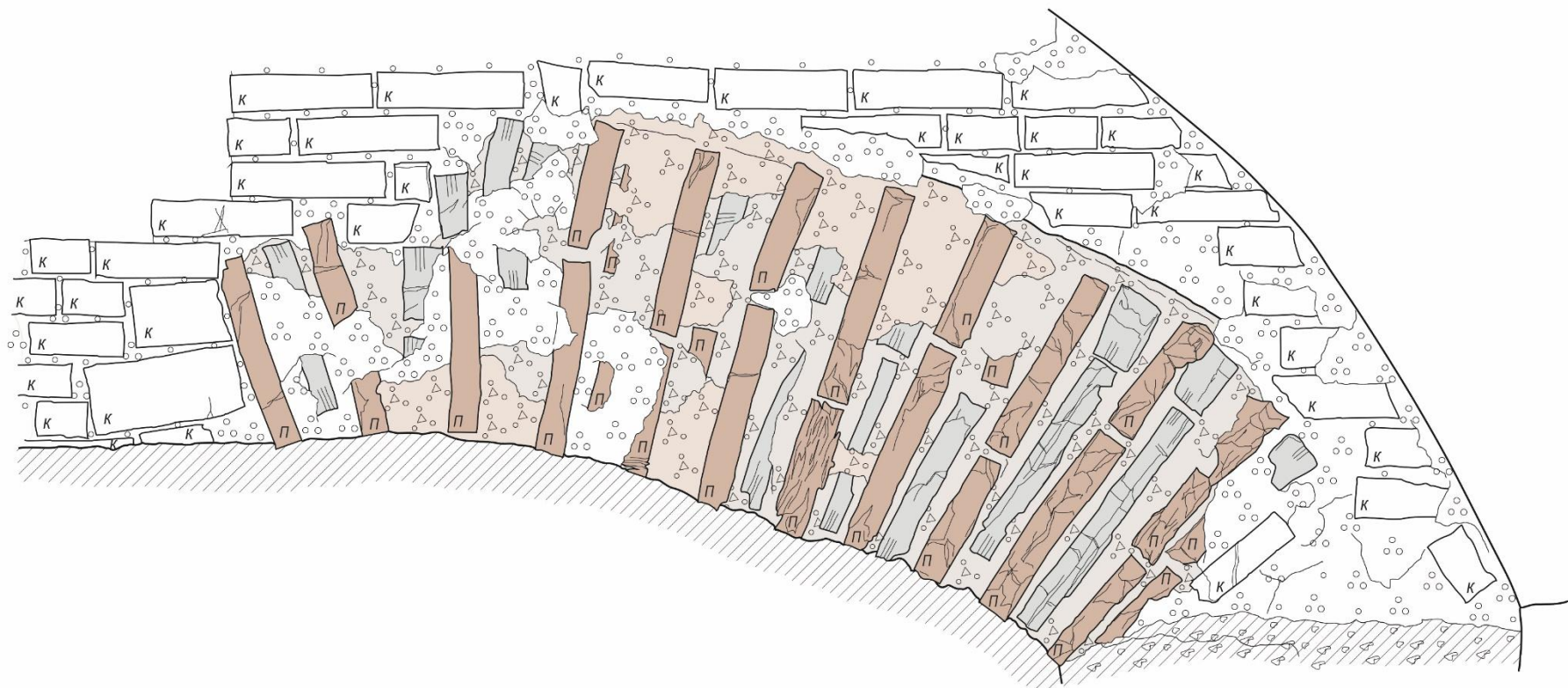

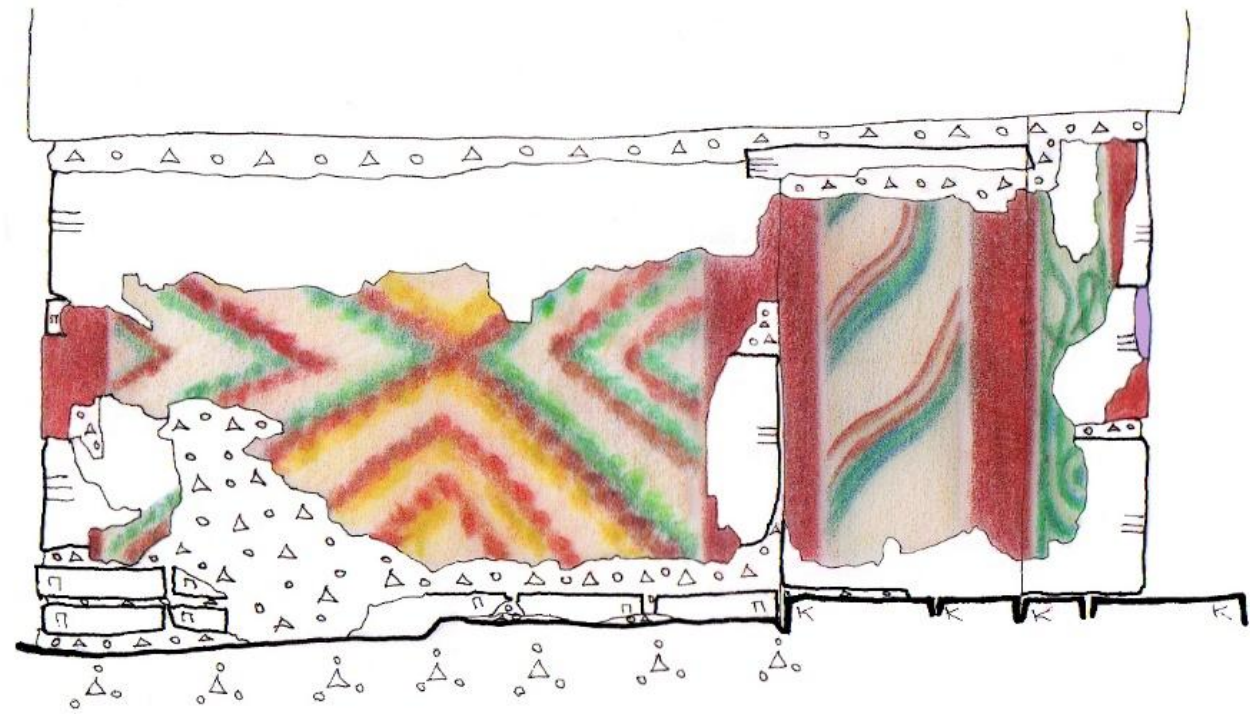
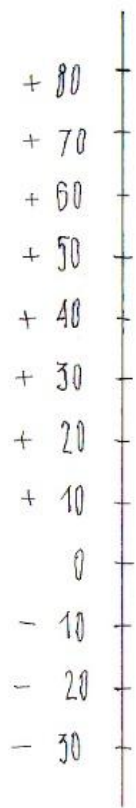

План

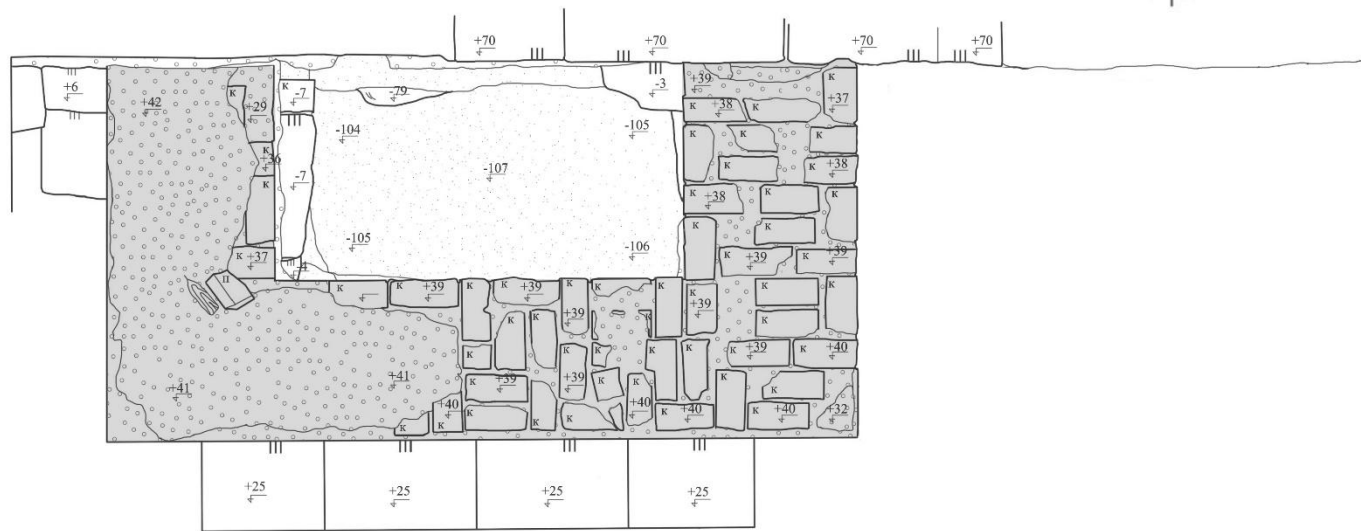

Сечение

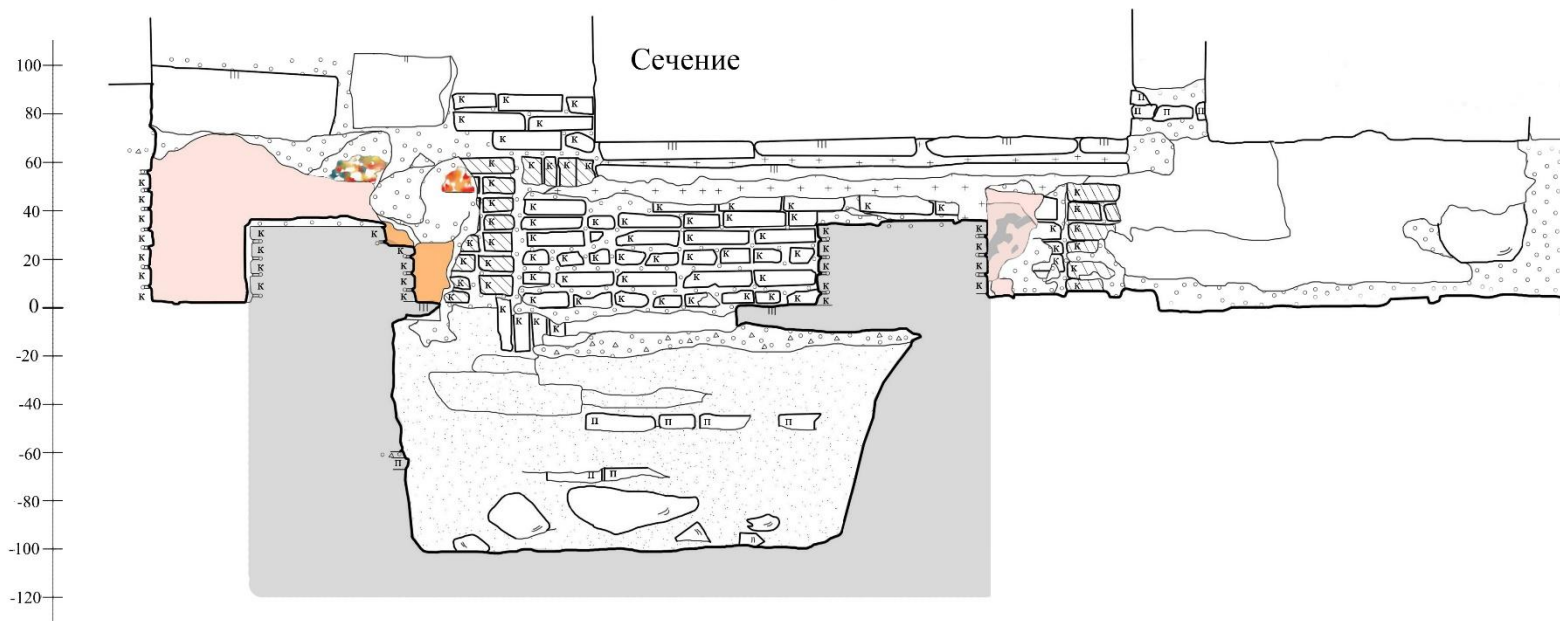

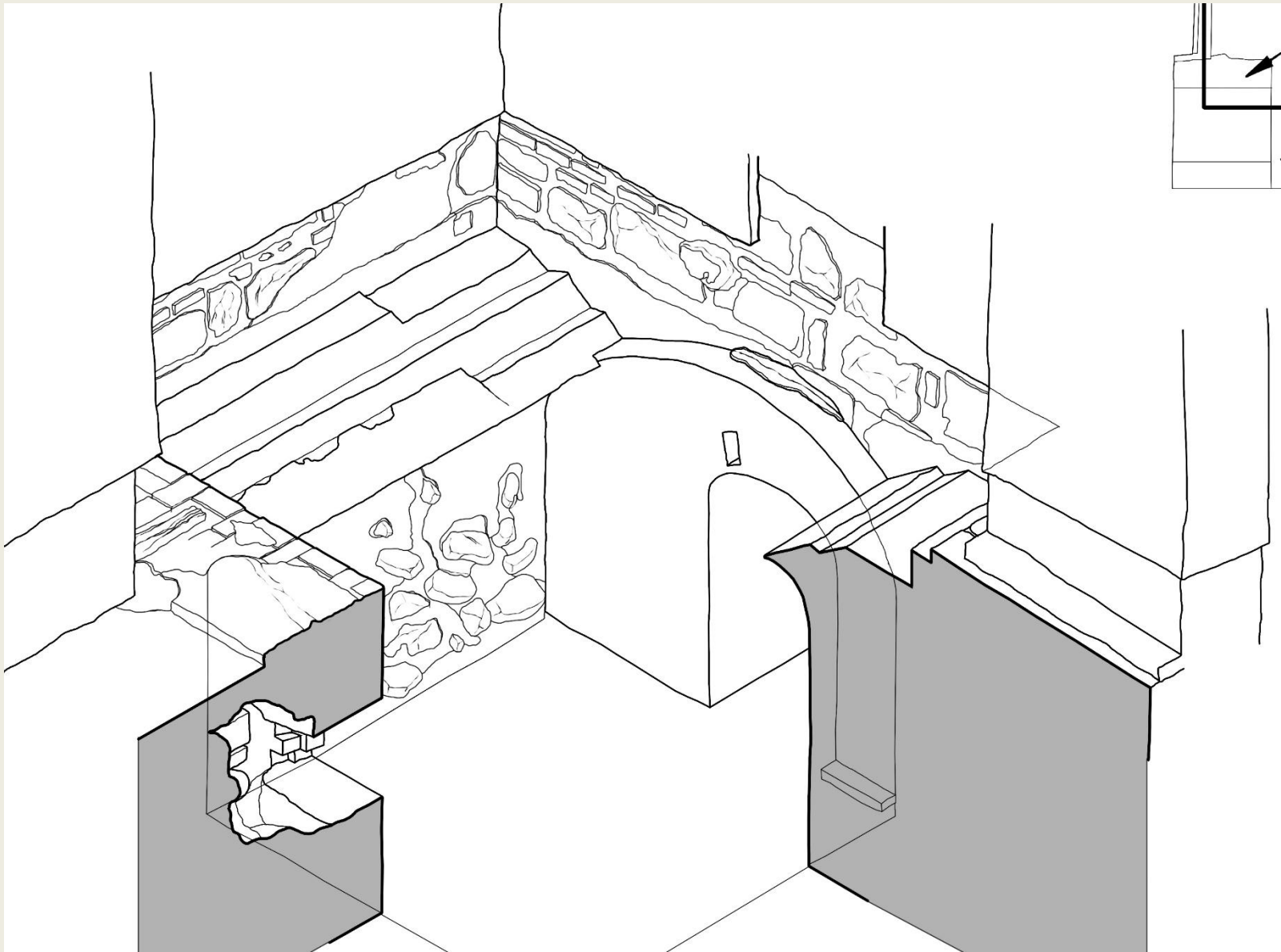

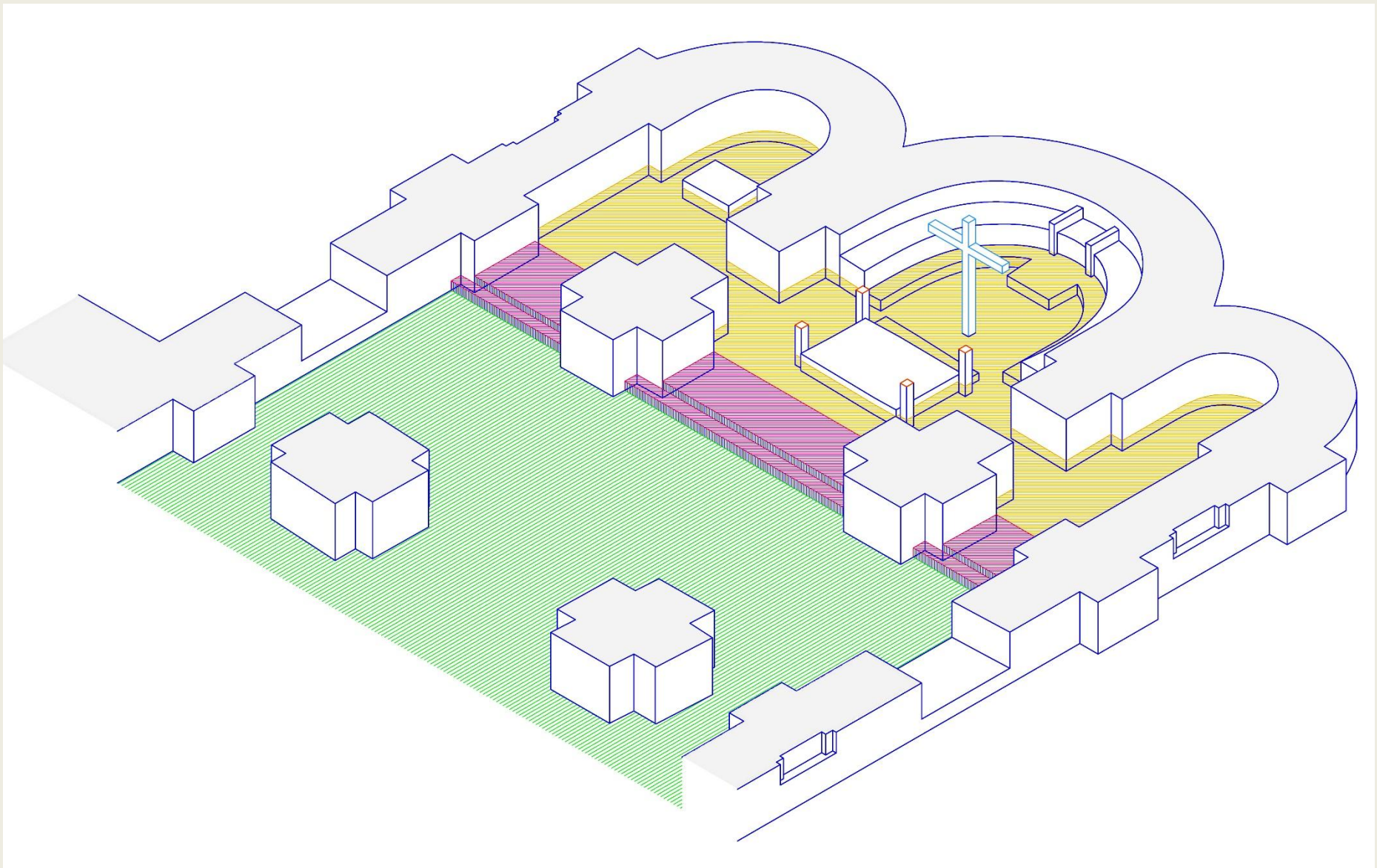

Реконструкция и анализ

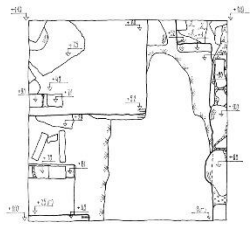

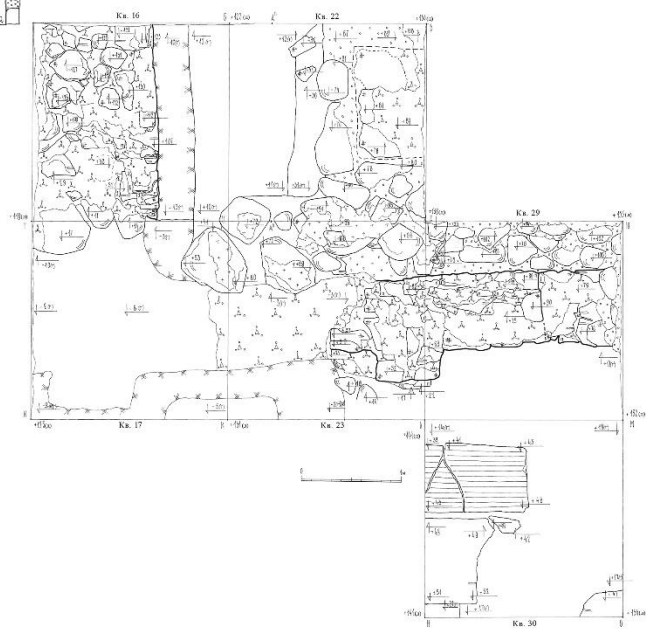
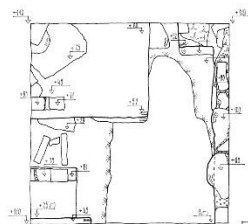

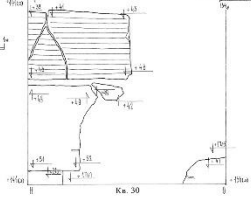
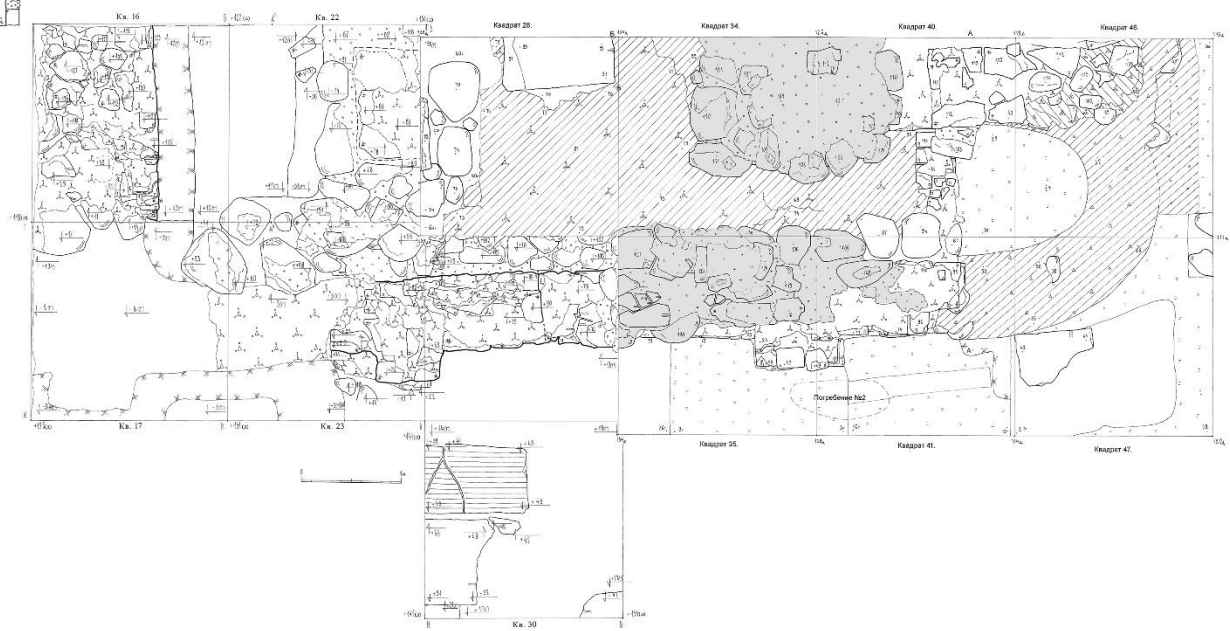
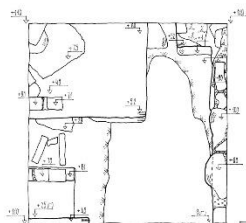

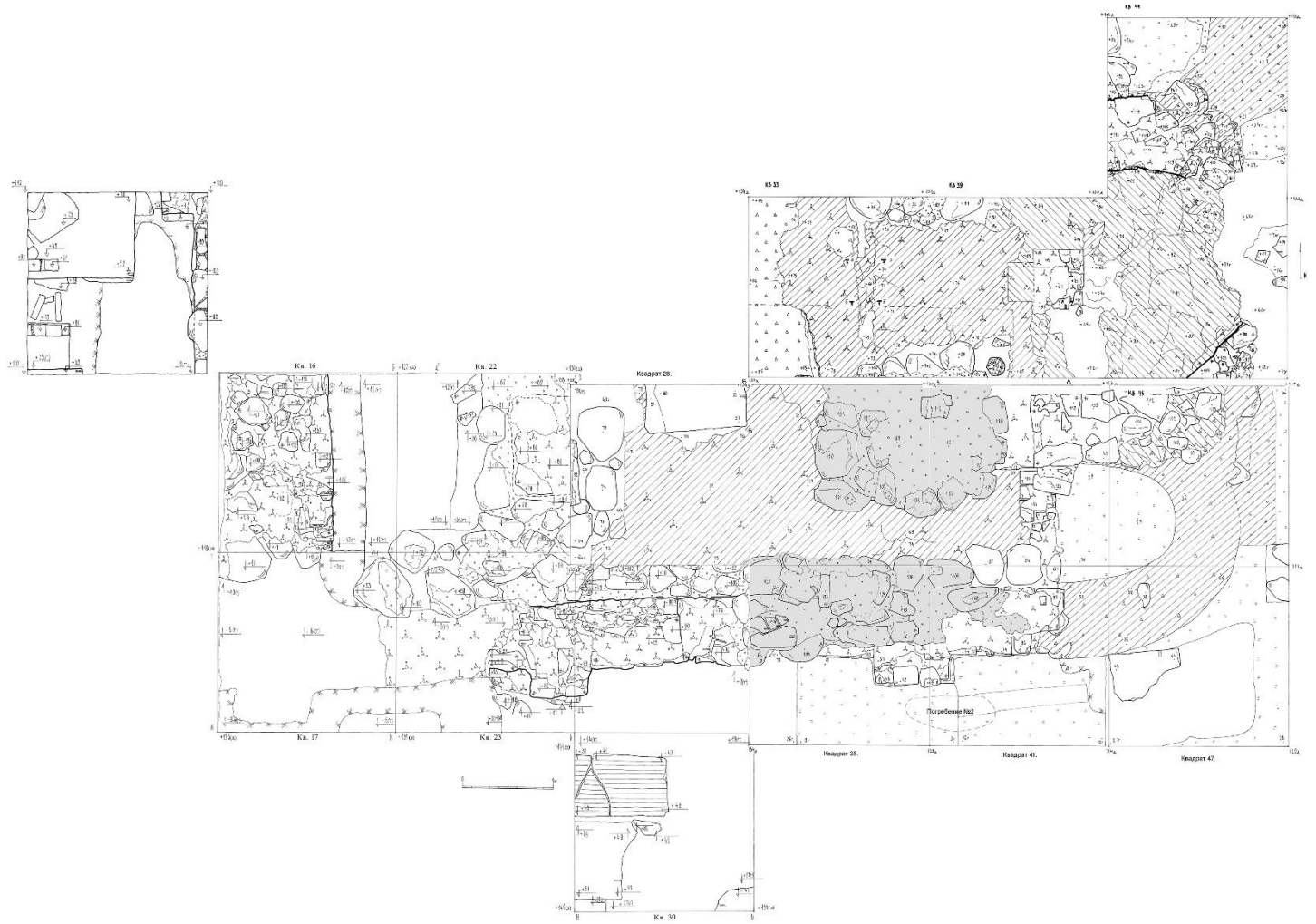

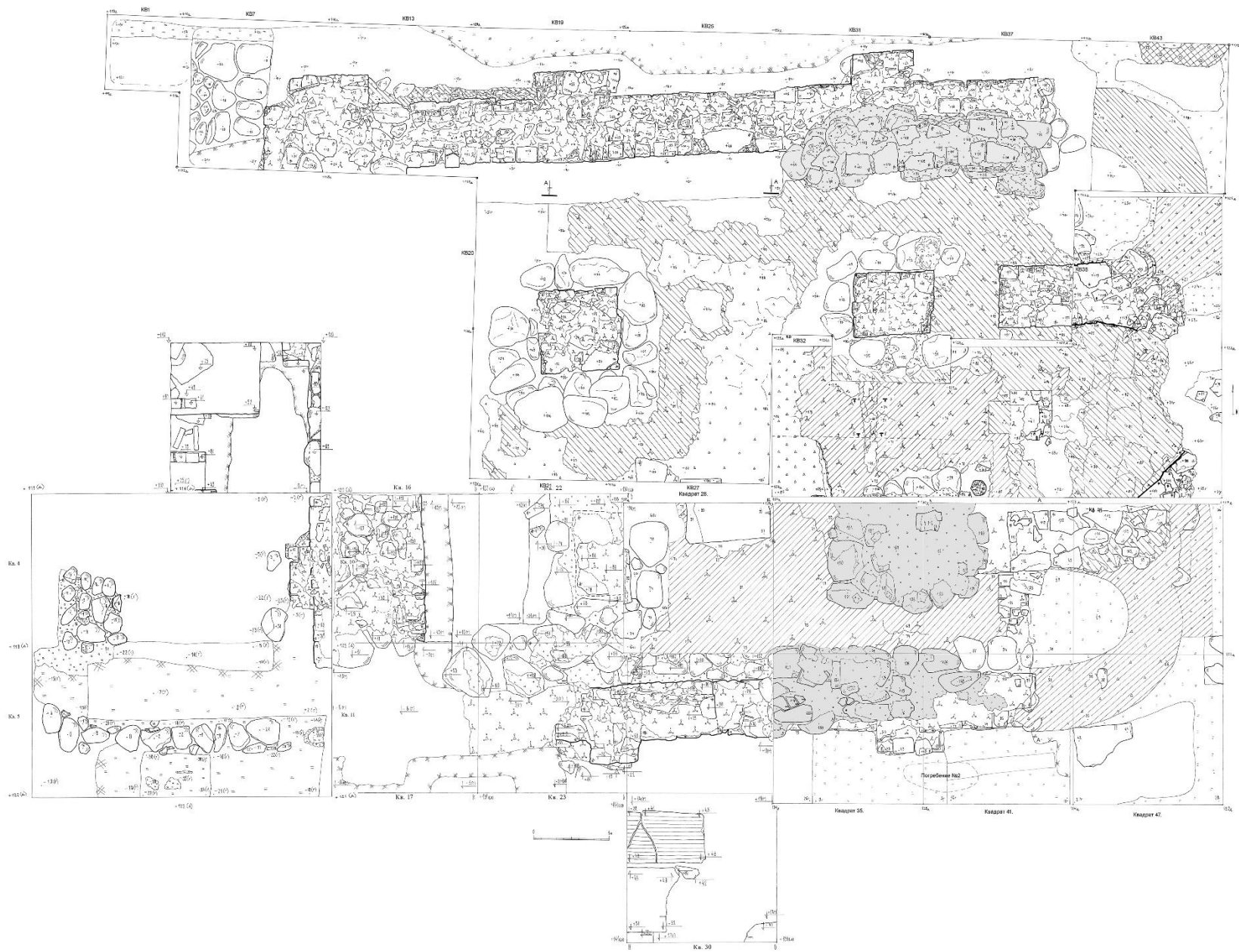

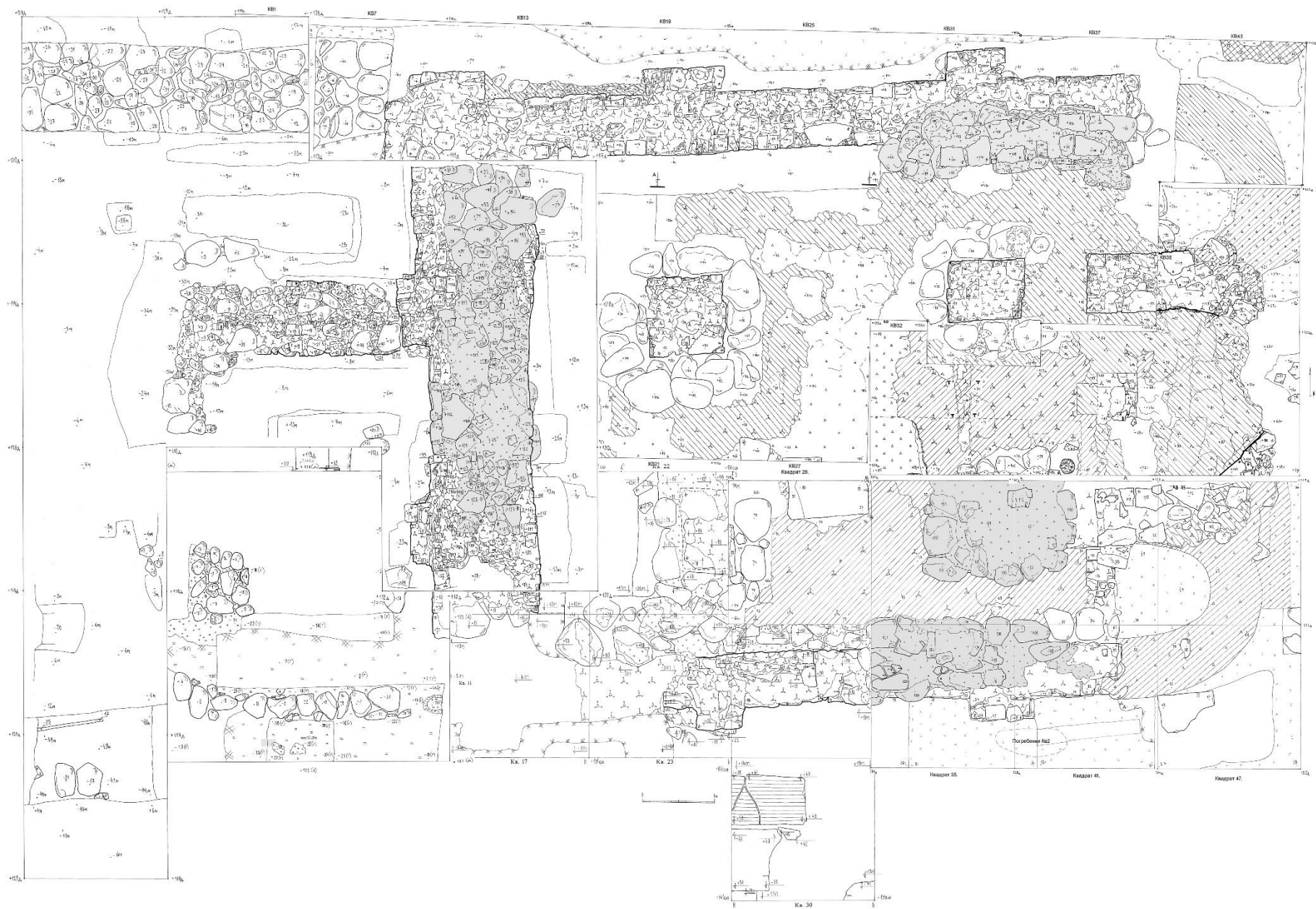

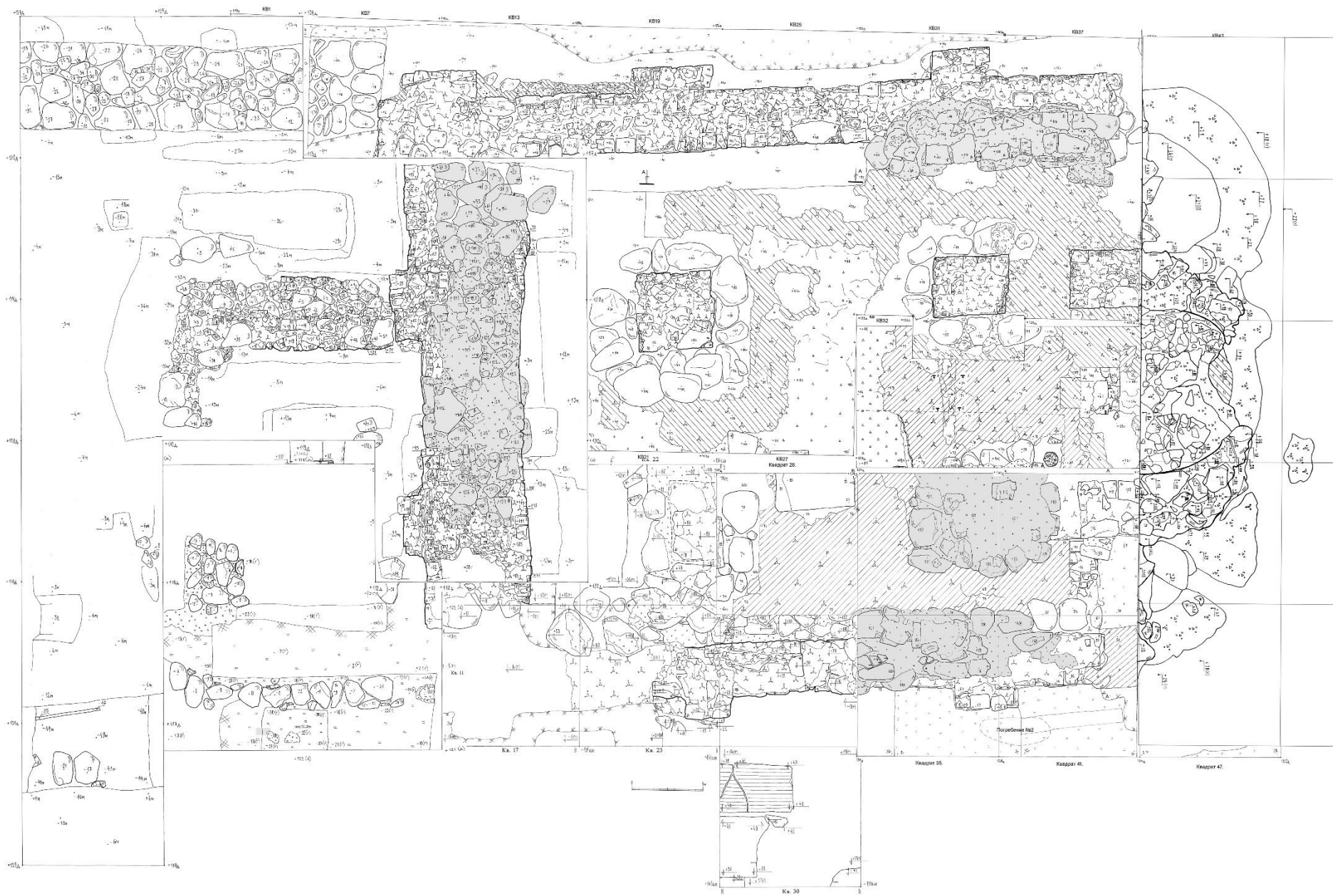

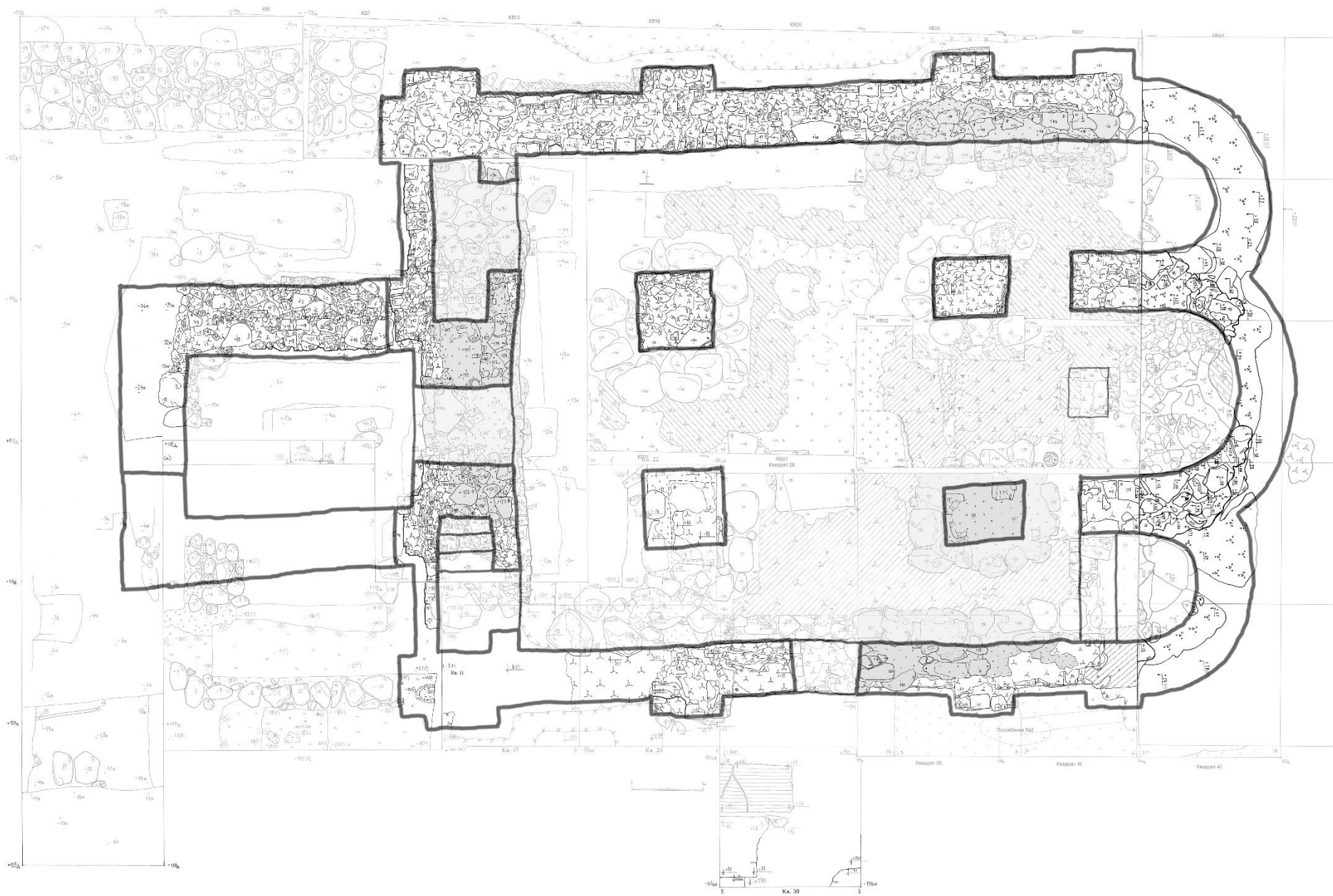

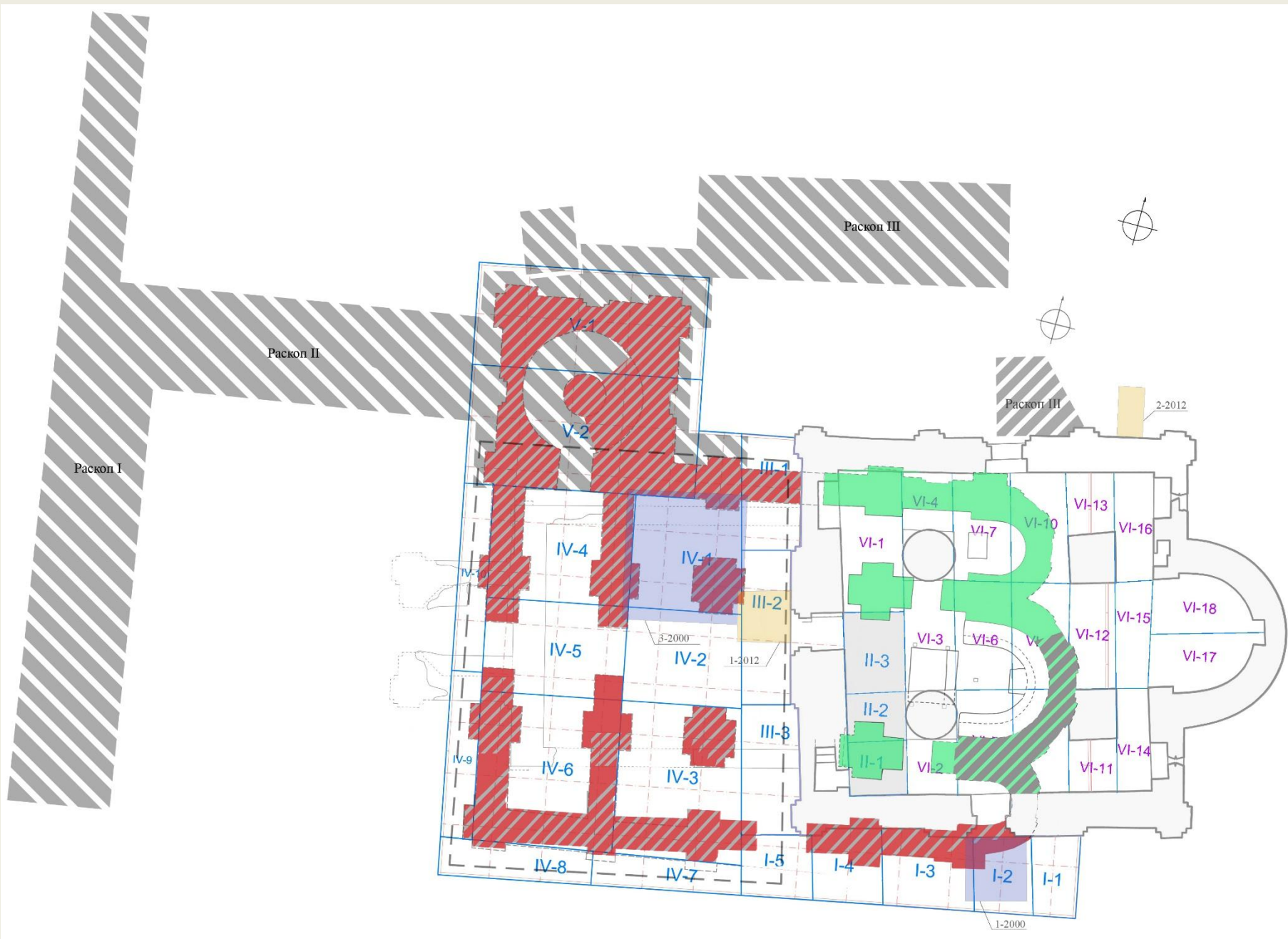

Ракон I

Ракон II

Ракон III

Ракон III

2-2012

V-1

V-2

III-1

IV-4

IV-1

III-2

VI-1

VI-4

VI-7

VI-10

VI-13

VI-16

VI-18

VI-17

VI-15

VI-12

VI-11

VI-14

IV-5

IV-2

3-2000

1-2012

VI-3

VI-6

II-3

VI-9

II-2

VI-5

IV-9

IV-6

IV-3

II-1

VI-2

IV-8

IV-7

I-5

I-4

I-3

1-2000

I-2

I-1



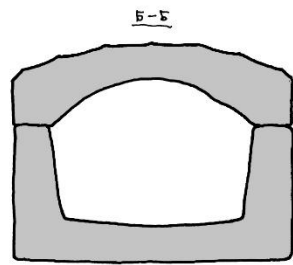
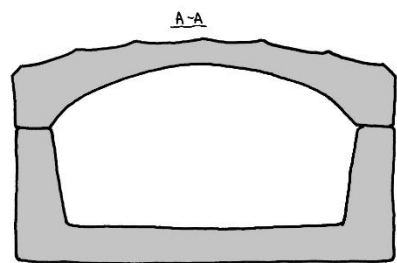
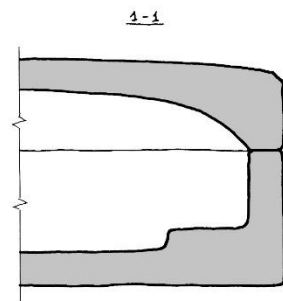
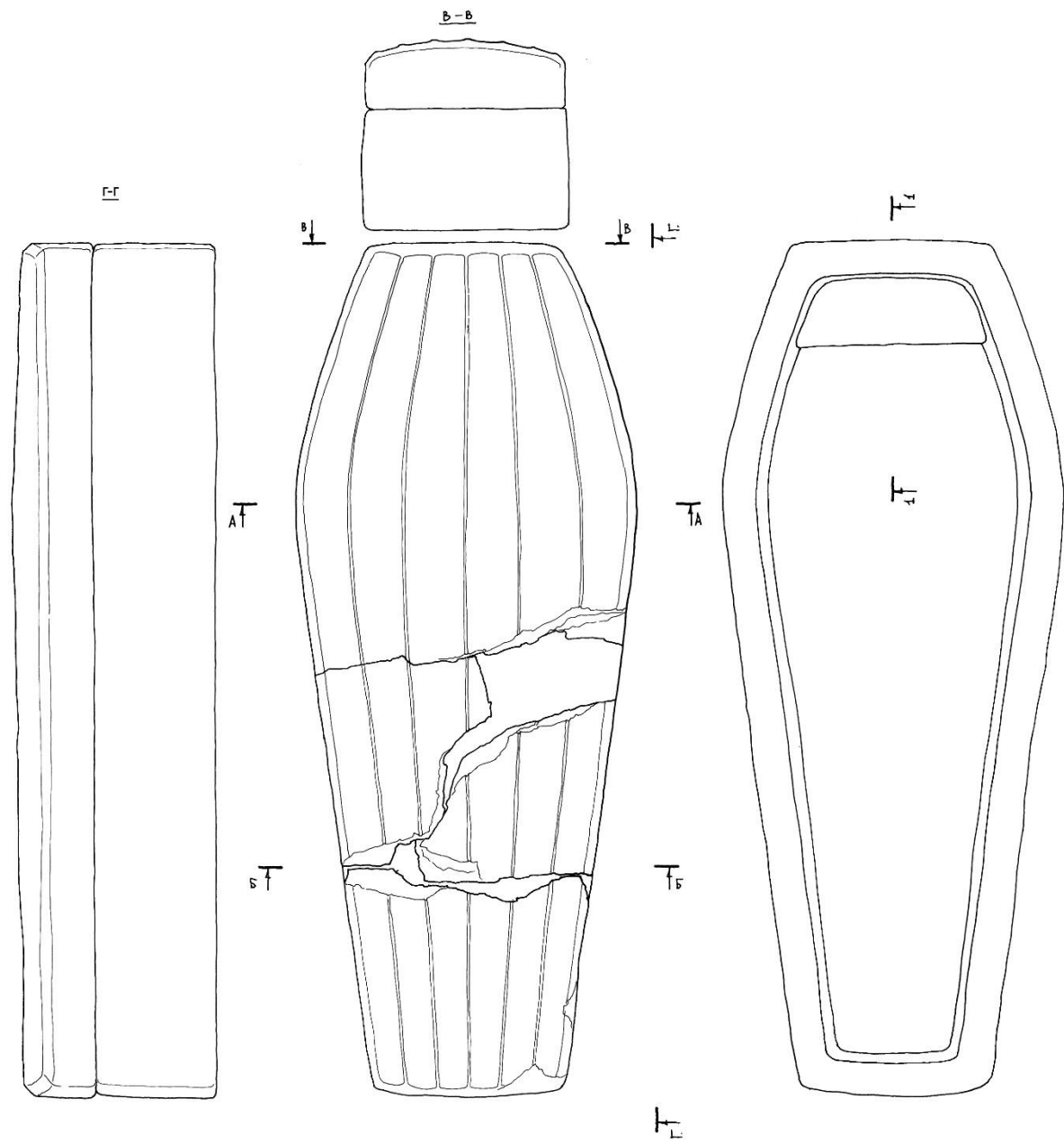



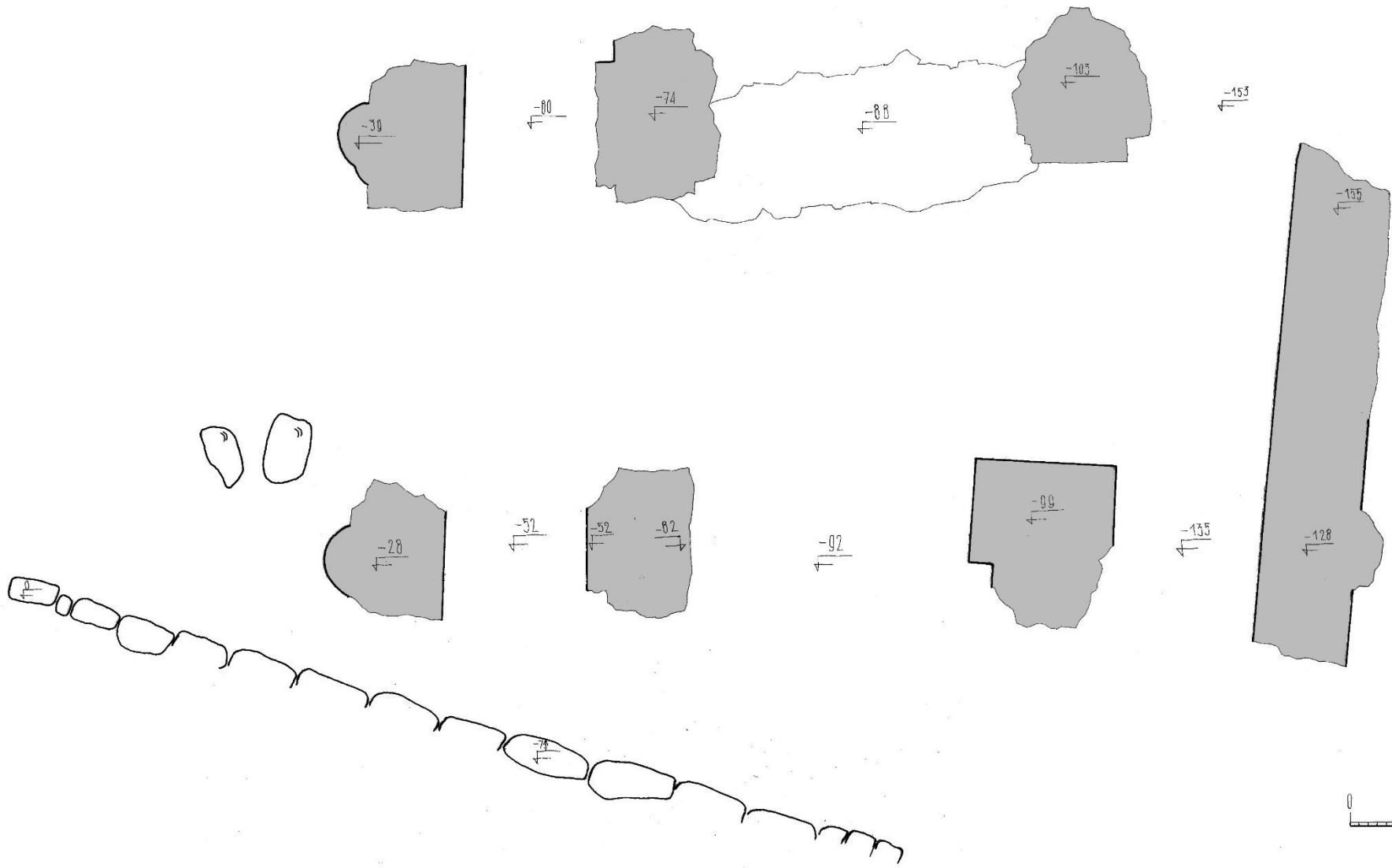



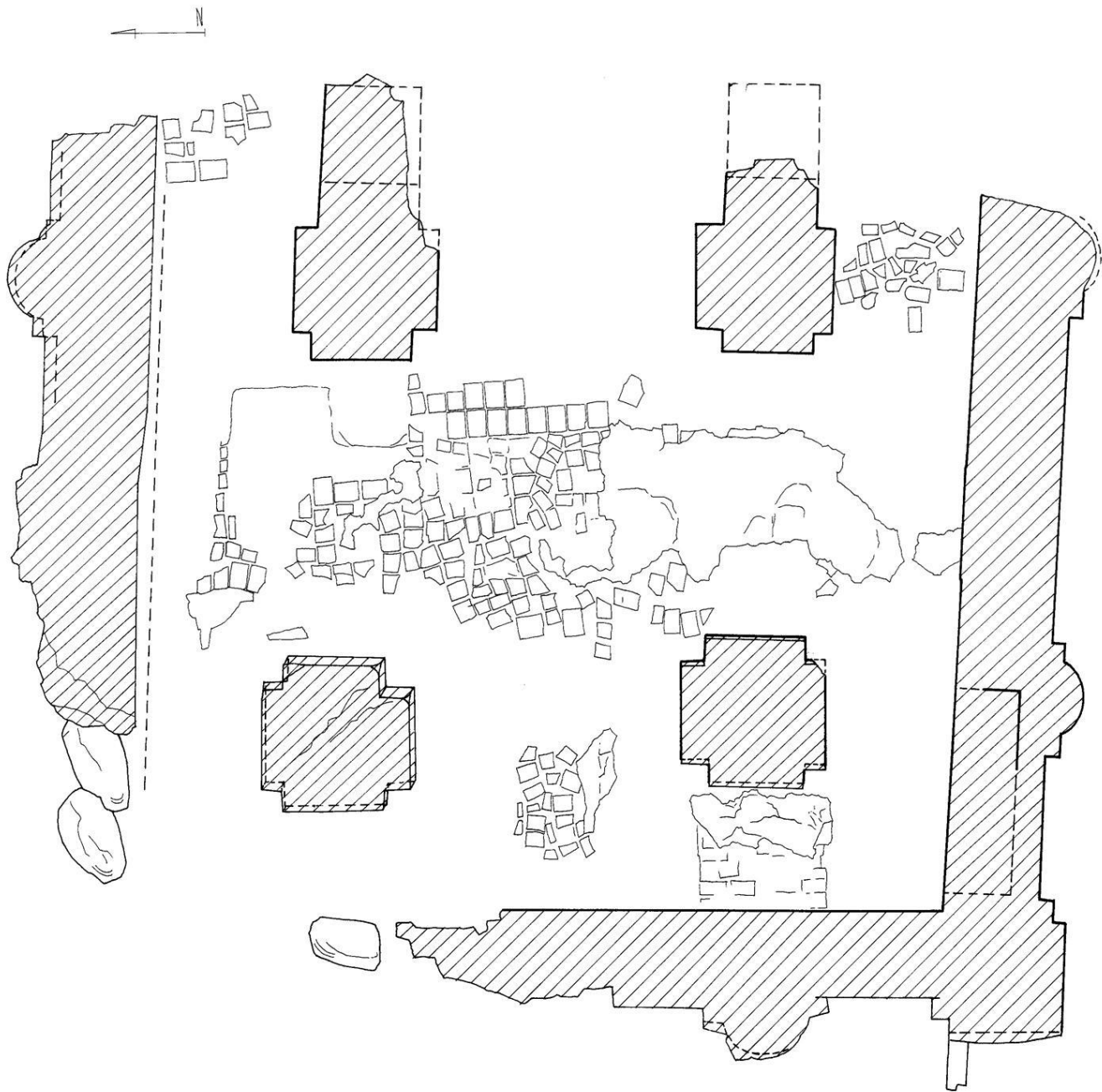

1 0 1 2 3 4m

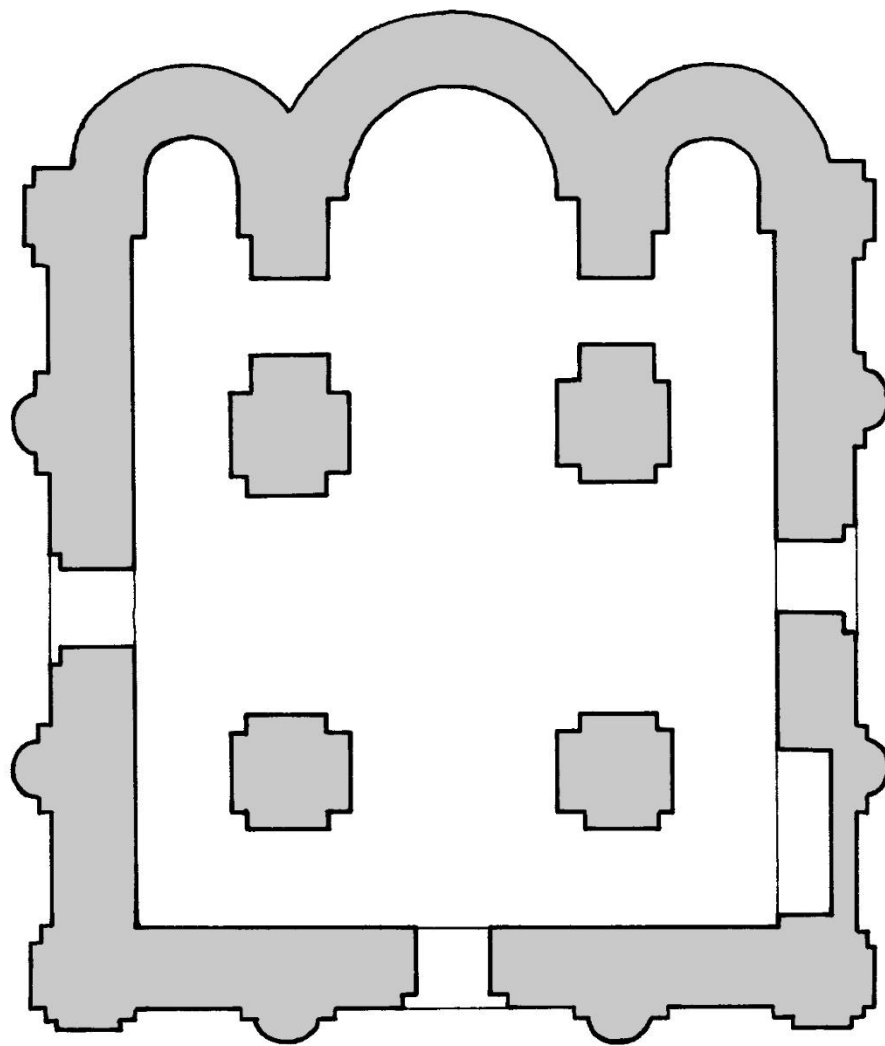

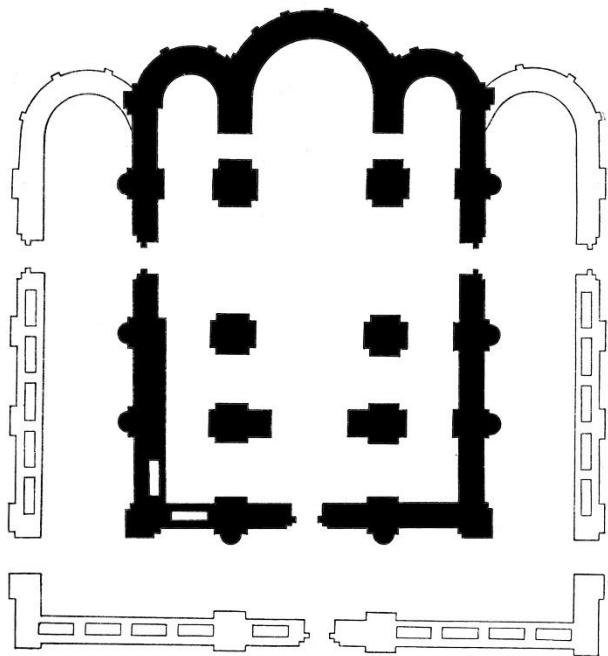

1

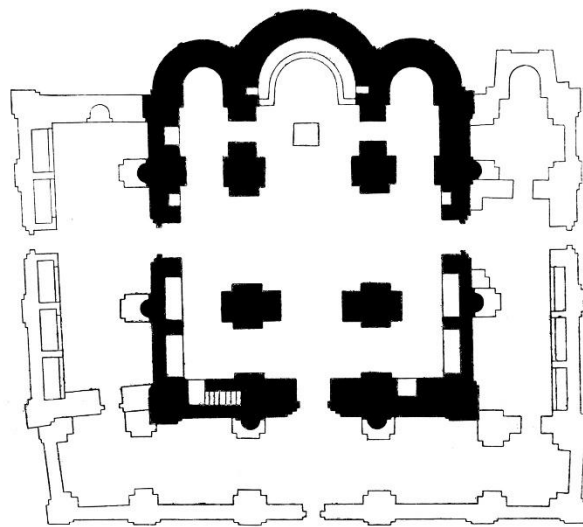

2

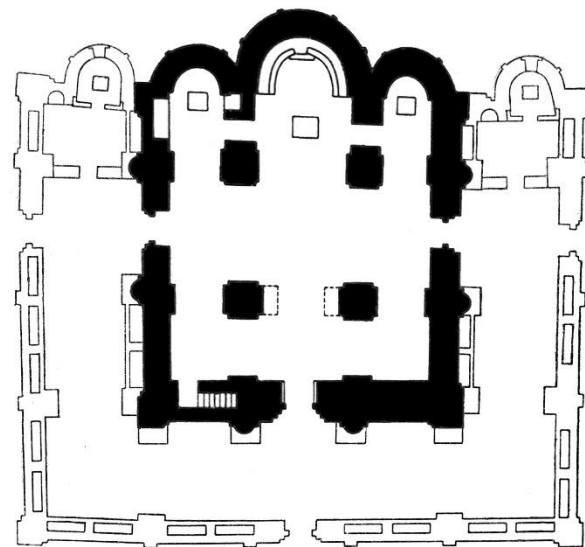

3

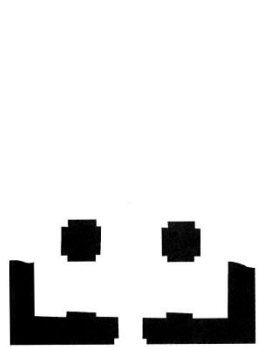

4

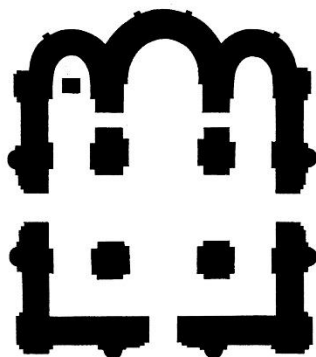

5

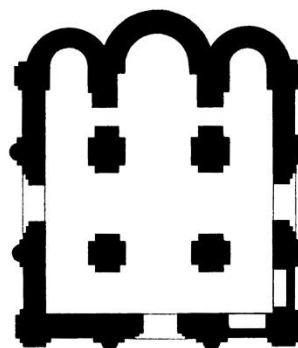

6

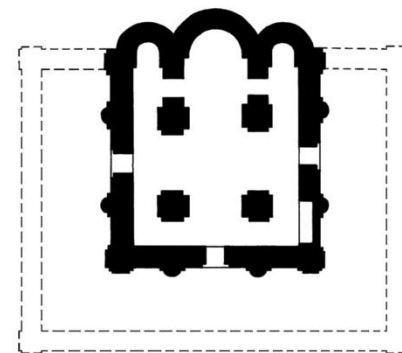

7

Памятники Смоленска XII в.

1 - Борисоглебский собор; 2 - ц. Петра и Павла; 3 - ц. Ивана Богослова;

4 - ц. в Перекопном пер.; 5 - ц. на ул. Соболева; 6 - ц. Василия;

7 - ц. на Б. Краснофлотской ул.

