

Chemical Energy Storage

Gamini Sumanasekera

Department of Physics and Astronomy, Univ. of
Louisville

Conn Center for Renewable Energy Research,
Univ. of Louisville

Energy Storage

Renewable energy is often intermittent (like wind and sun), and storage allows use at a convenient time.

Energy is stored to use it at a different time than when it was generated.

The process of converting the energy to storable form means that some energy is lost.

Additional energy is lost when the energy is released or recovered.

Ideally, storage is avoided to have a more efficient process.

Renewable Energy:

Energy source/fuel type that can regenerate and can replenish itself indefinitely.

Biomass, Wind, Solar, hydro, geothermal

Energy comes in two basic forms: potential and kinetic

Potential Energy is any type of stored energy. It can be chemical, nuclear, gravitational, or mechanical.

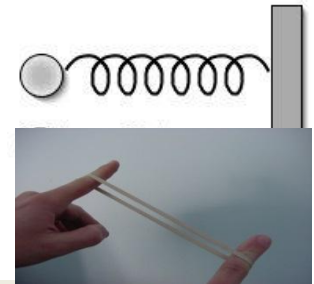
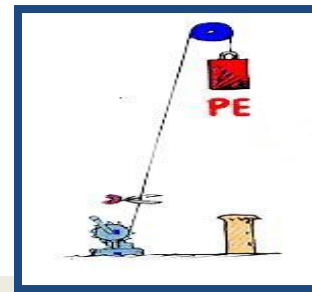
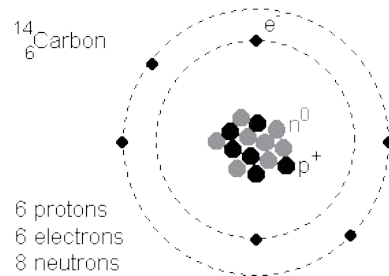
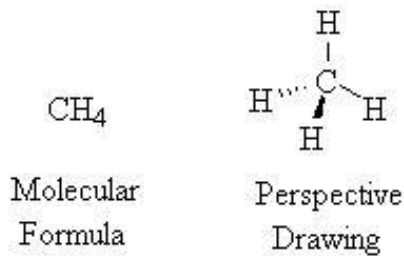

Kinetic Energy is found in movement. A flying airplane, a plummeting meteor each have kinetic energy. Even the tiniest things have kinetic energy, like atoms vibrating when they are hot or when they transmit sound waves. Electricity is the kinetic energy of flowing electrons.

$$E = \frac{1}{2} m \cdot v^2$$

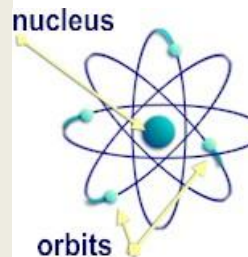

Energy Conversion

- Hydroelectric power plants take advantage of the gravitational potential energy of water as it falls from the top of a dam to the bottom.
- A car transforms the potential energy trapped in gasoline into Energy
- Coal and natural gas use the chemical potential energy trapped in fossil fuels.
- Nuclear power plants change the nuclear potential energy of uranium or plutonium into electricity too.
- Wind turbines change the kinetic energy of air molecules in wind into electricity.

Units of Energy and Power

The **joule (J)** is a measure of energy, or the ability or capacity to do work.

The **watt (W)** is a measure of *electric* power. (Power is the rate of doing work or producing or expending energy.)

One watt is equal to 1 joule (J) per second. A **megawatt (MW)** is one million watts.

Other measures of energy are **kilowatt-hour (kWh)**, a thousand watts of power produced or used for one hour, equivalent to 3.6 million joules (MJ).

British thermal unit (Btu), equivalent to 1,055 J or 0.293 Wh.

Million (MM) Btu = 1,055 MJ = 293 kWh.

Types of Energy Storage

Electricity can be stored by converting it into another form such as potential, kinetic or chemical energy.

Electrical energy storage technologies include the following types of storage media:

- Flywheel energy storage (FES)
- Super capacitor energy storage (SCES)
- Superconducting magnetic energy storage (SMES)
- *Compressed air energy storage (CAES)*
- *Pumped hydro energy storage (PHES)*
- **Battery electric storage system (BESS)**

Energy Storage

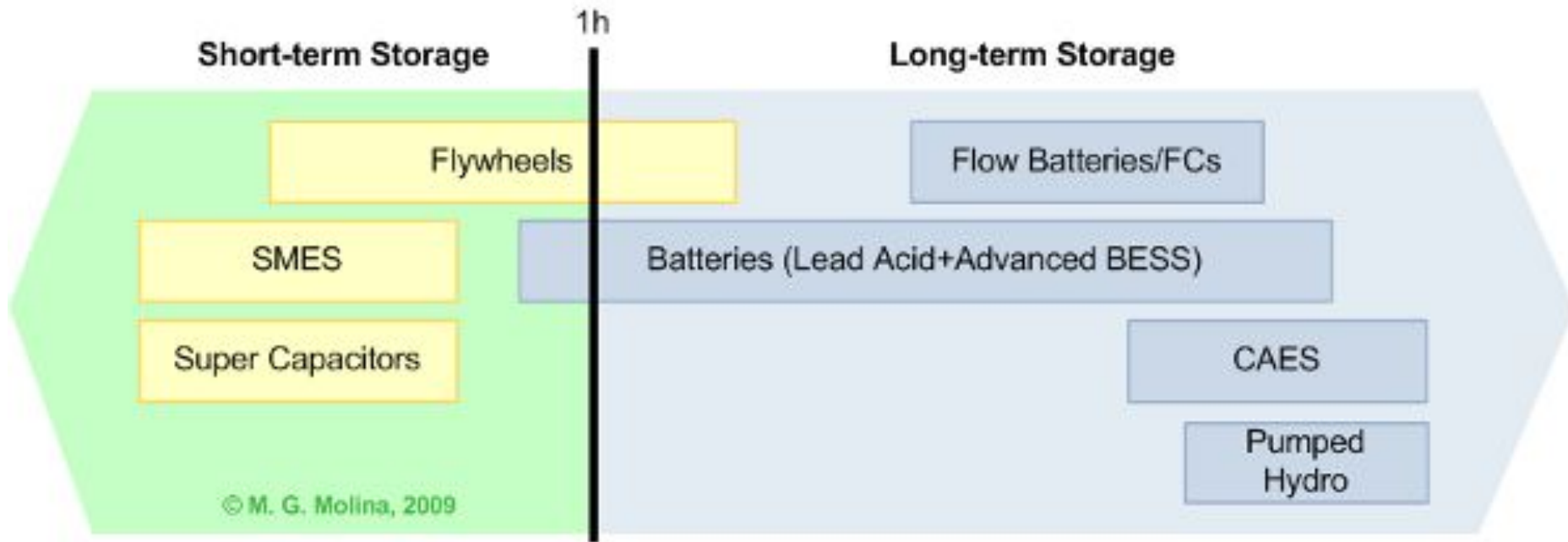

Electrical Power & Energy Storage Comparison

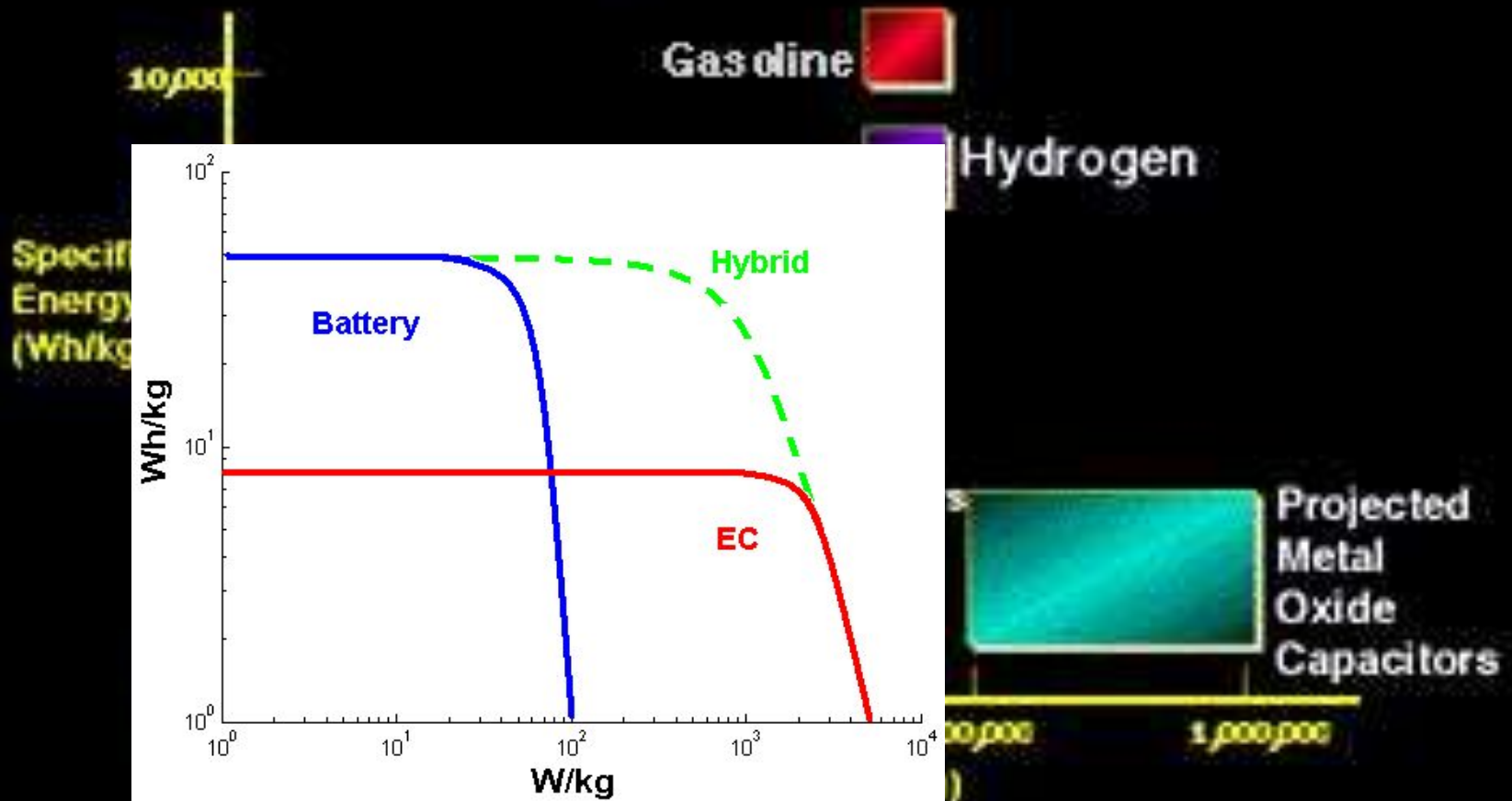

Compressed Air Energy Storage (CAES)

When required, the pressurized air is heated and expanded in an expansion turbine

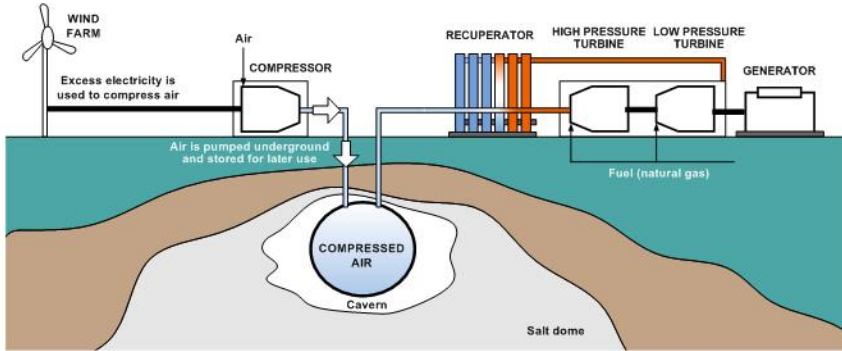

Flywheels

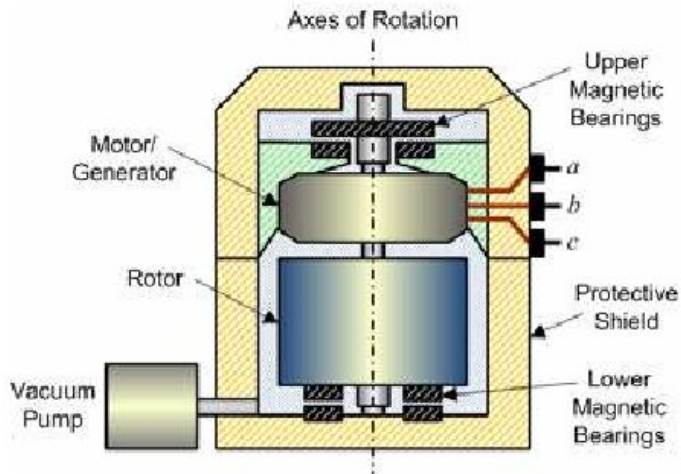

Flywheels store energy as angular momentum
Magnetic bearings reduce bearing friction to 2% of speed drop per day

Pumped Hydro Energy Storage (PHES)

Stored water is released during high electrical demand

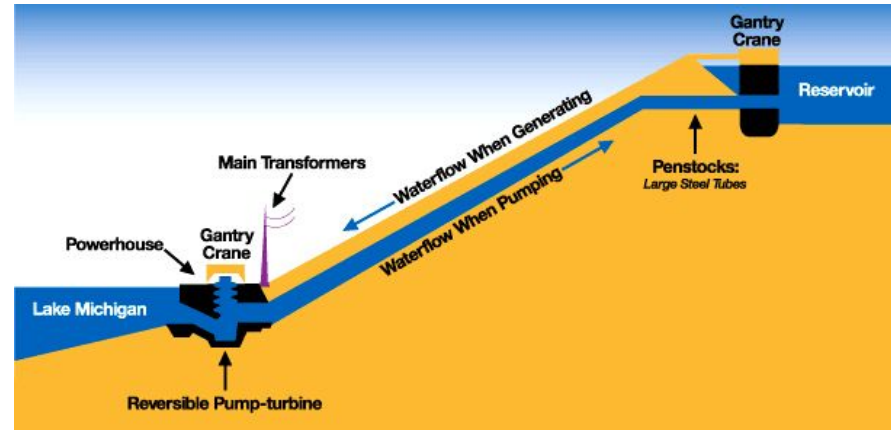

Superconductor energy storage (SCES)

Stores energy in the magnetic field created by the flow of direct current in a superconducting coil

Since a superconductor has essentially zero resistance, a current once started will flow “forever” (persistent current)

At a later time, energy could be extracted from the superconductor by discharging the coil

Battery Electric Storage System (BESS)

- have high energy densities
- technology is matured
- relatively easy to use

Let us consider the following battery types:

- Lead-acid
- **Lithium ion (Li-ion)**
- Lithium sulphur (Li-S)
- Flow Batteries (Stationary Electrical
Energy Storage)

Battery status in transportation

	Now	Target
Energy Density (Wh/kg or Wh/L)	220 Wh/kg	500 Wh/kg
Cost	\$150/kWh	\$60/kWh
Cycle Life	1000 cycles 7 years	5000-10000 cycles 20-25 years
Charge Rate	1-2 hours	<10 min
Safety	Not safe	Safe

Energy Usage

- Cell Phones 10 Wh
- Drones 70 Wh
- Tesla 85,000 Wh
- World 10 TWh

Li-ion

	Cell level (goal)	System level (goal)
Energy (Wh/kg)	200 (600)	100 (300)
Cost(\$/kWh)	15-200 (70)	300-500 (150)

ELECTROCHEMICAL ENERGY TECHNOLOGIES

Alternative Energy Technologies

- Solar, wind, nuclear, hydro, geothermal, fuel cells, batteries, supercapacitors
- **Fuel cells, batteries, supercapacitors:** Only viable option for automobiles (~ 30%)
- **Batteries:** Critical for storing and efficiently utilizing solar and wind energies

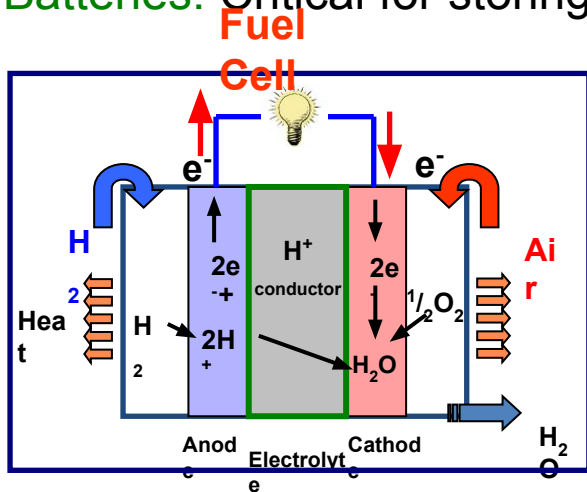

Conversion Device

Portable, transportation, & stationary

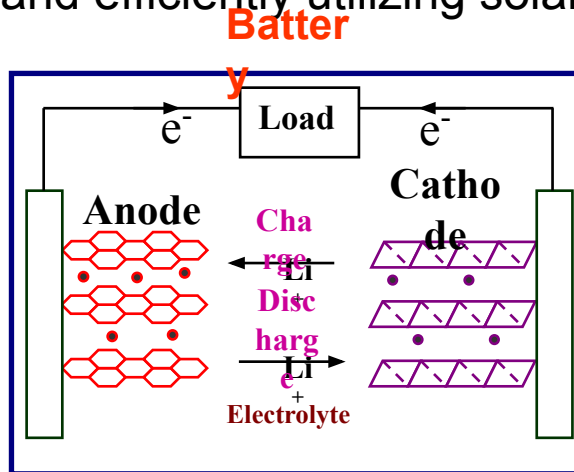

Storage Device

Portable, transportation, & stationary

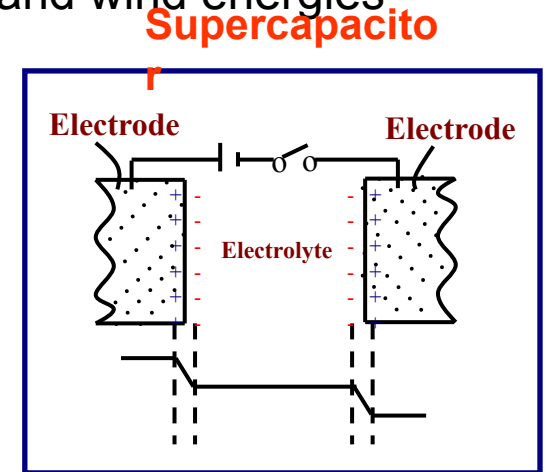

Storage Device

Portable & transportation



On-Site Power Generation



- Chemical energy directly into electrical energy – clean energy technologies
- **Challenges:** high cost, safety, durability, & operability problems

HIGH ENERGY CATHODES FOR LITHIUM ION BATTERIES

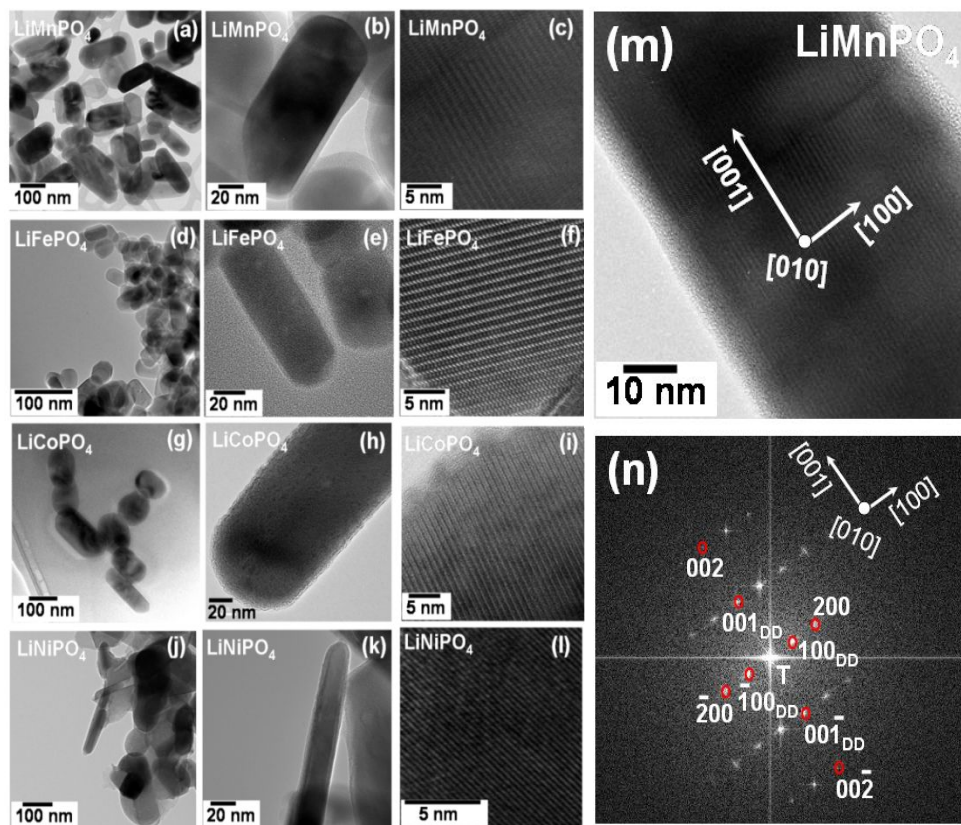
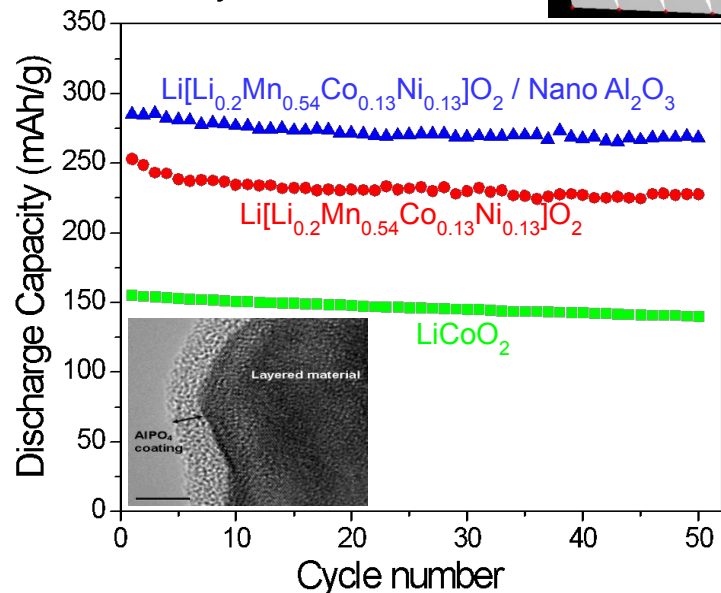
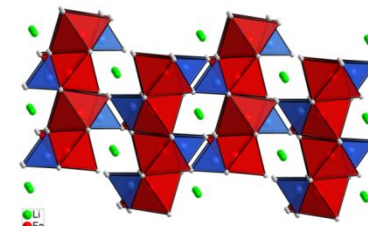
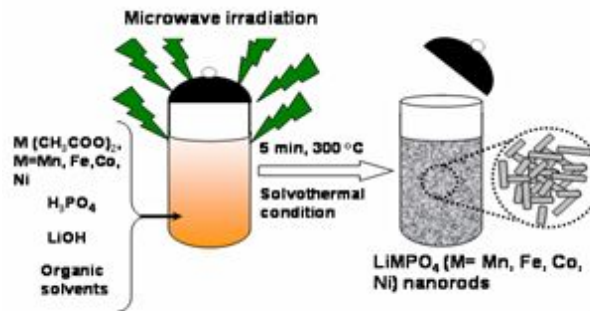
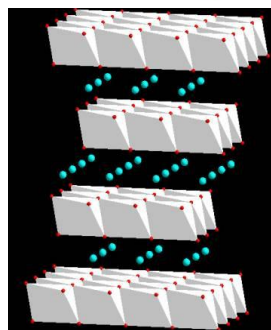
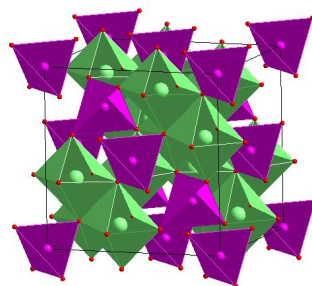
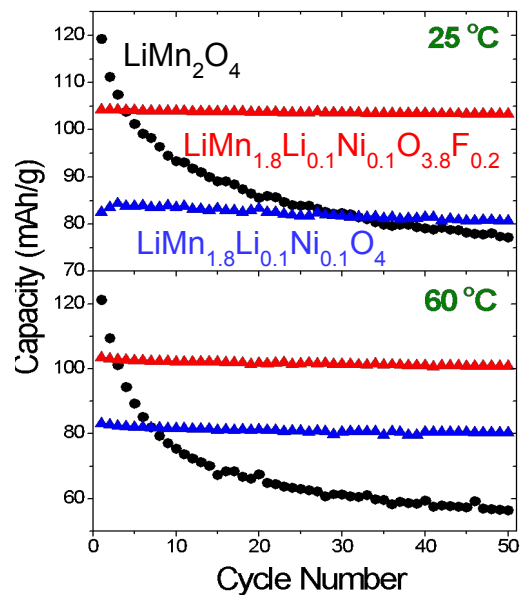

NANO-ENGINEERED ANODES FOR LITHIUM ION BATTERIES

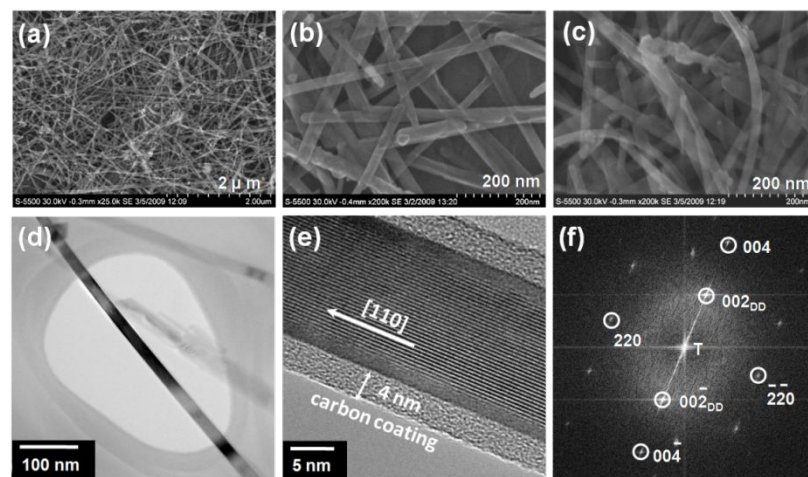
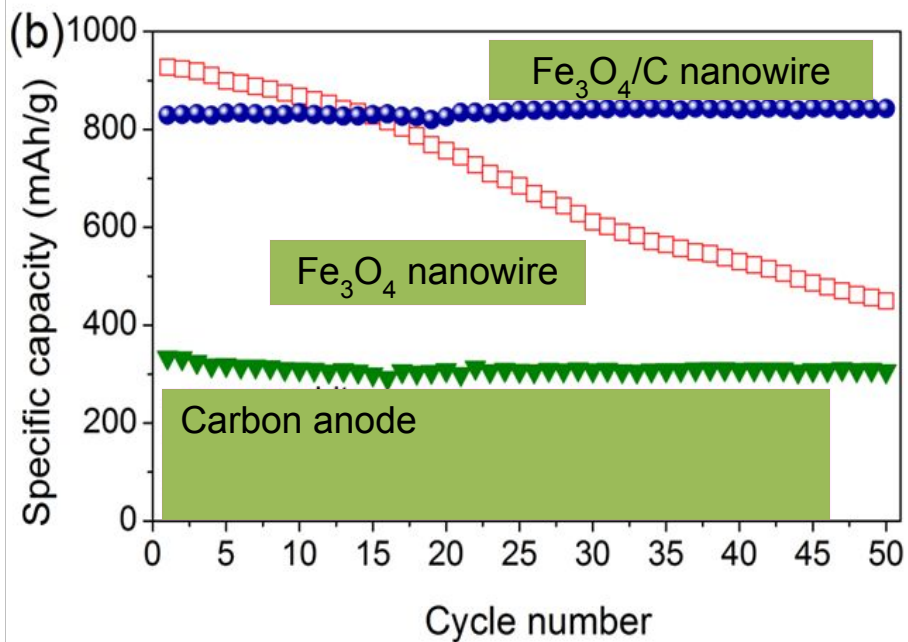
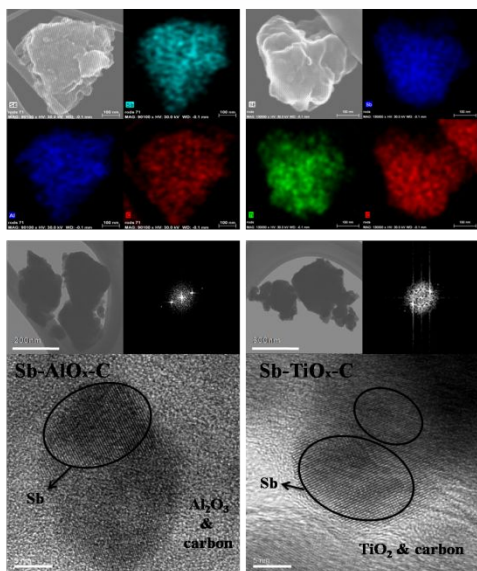
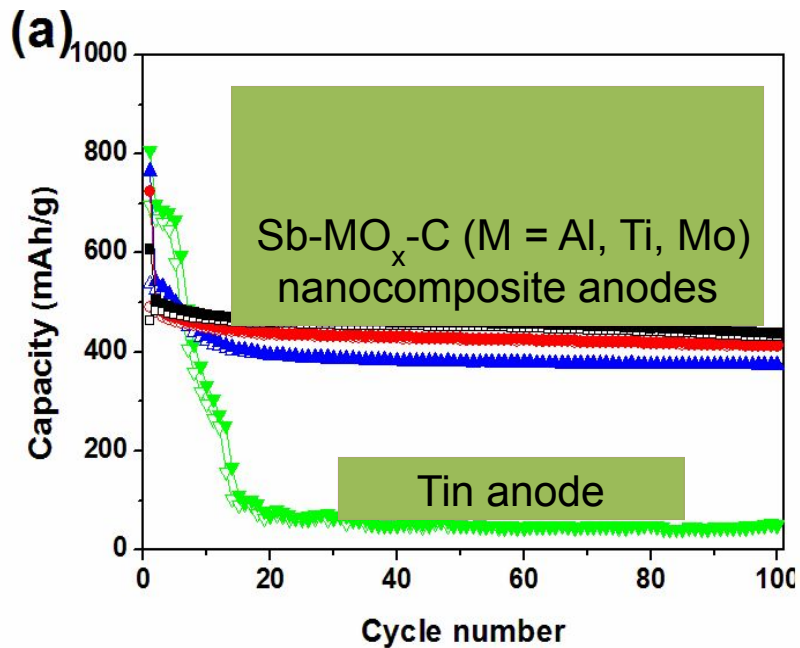

Energy Density – Storage Systems

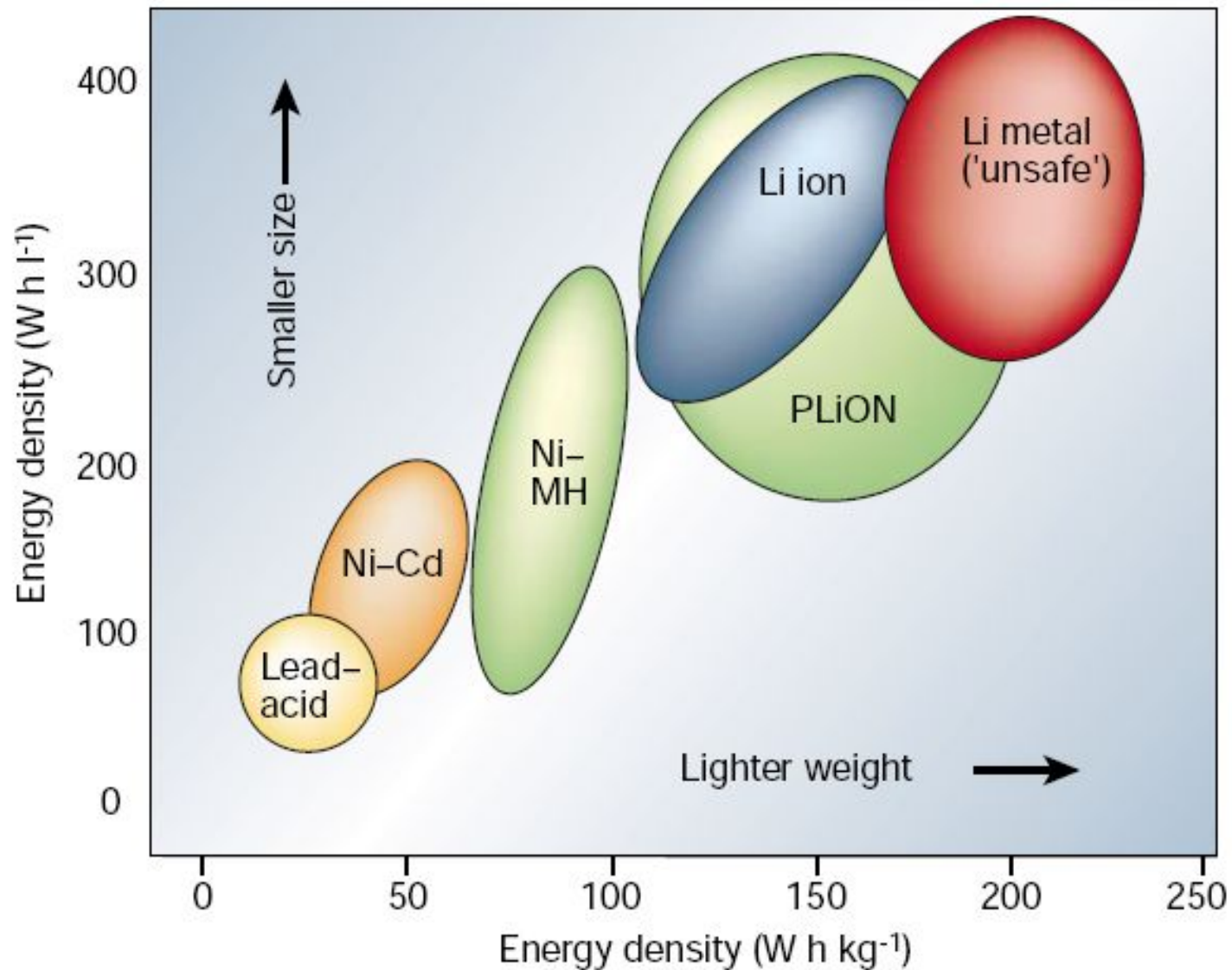

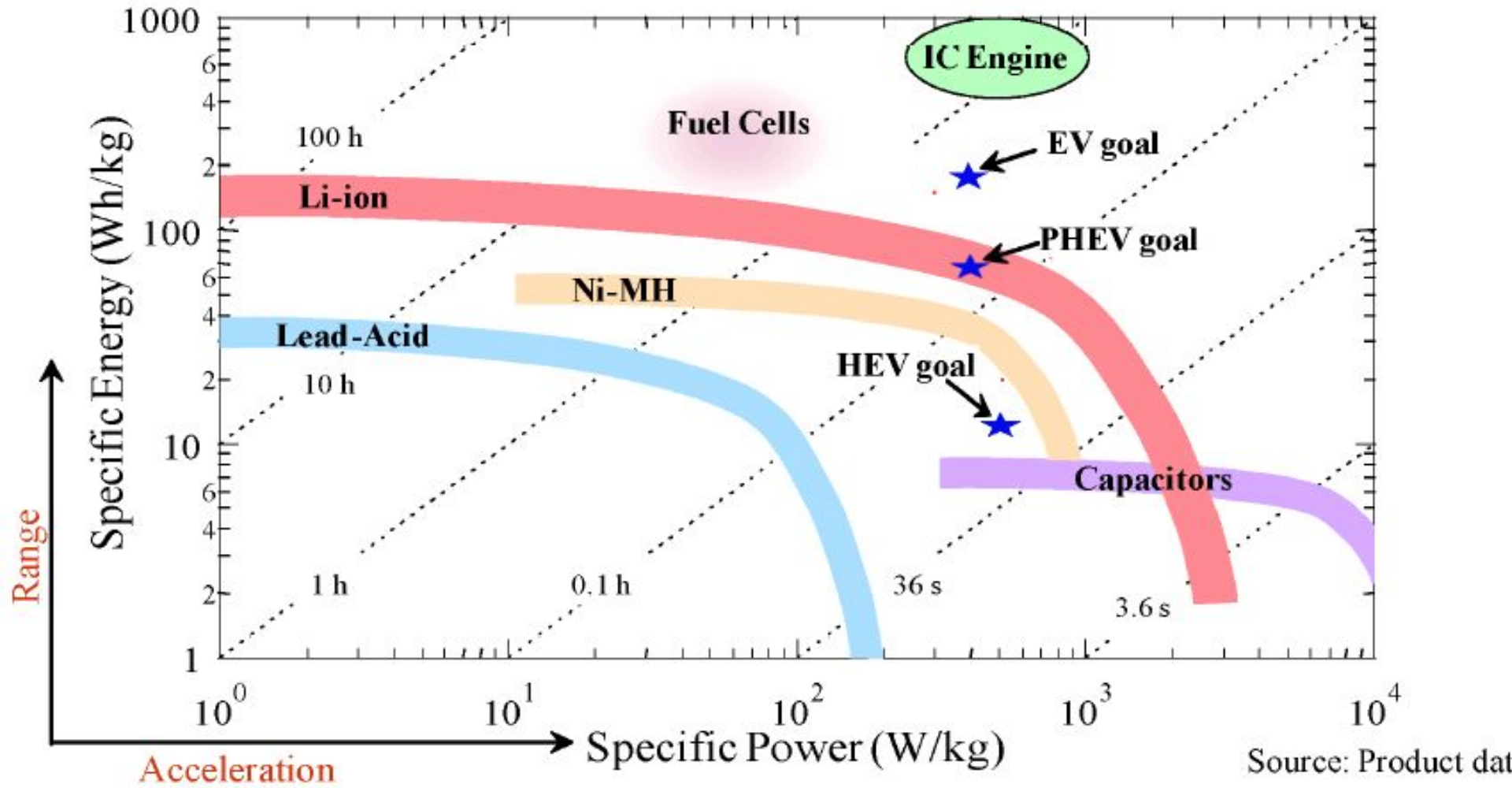

Most common anode and cathode materials for Li based batteries

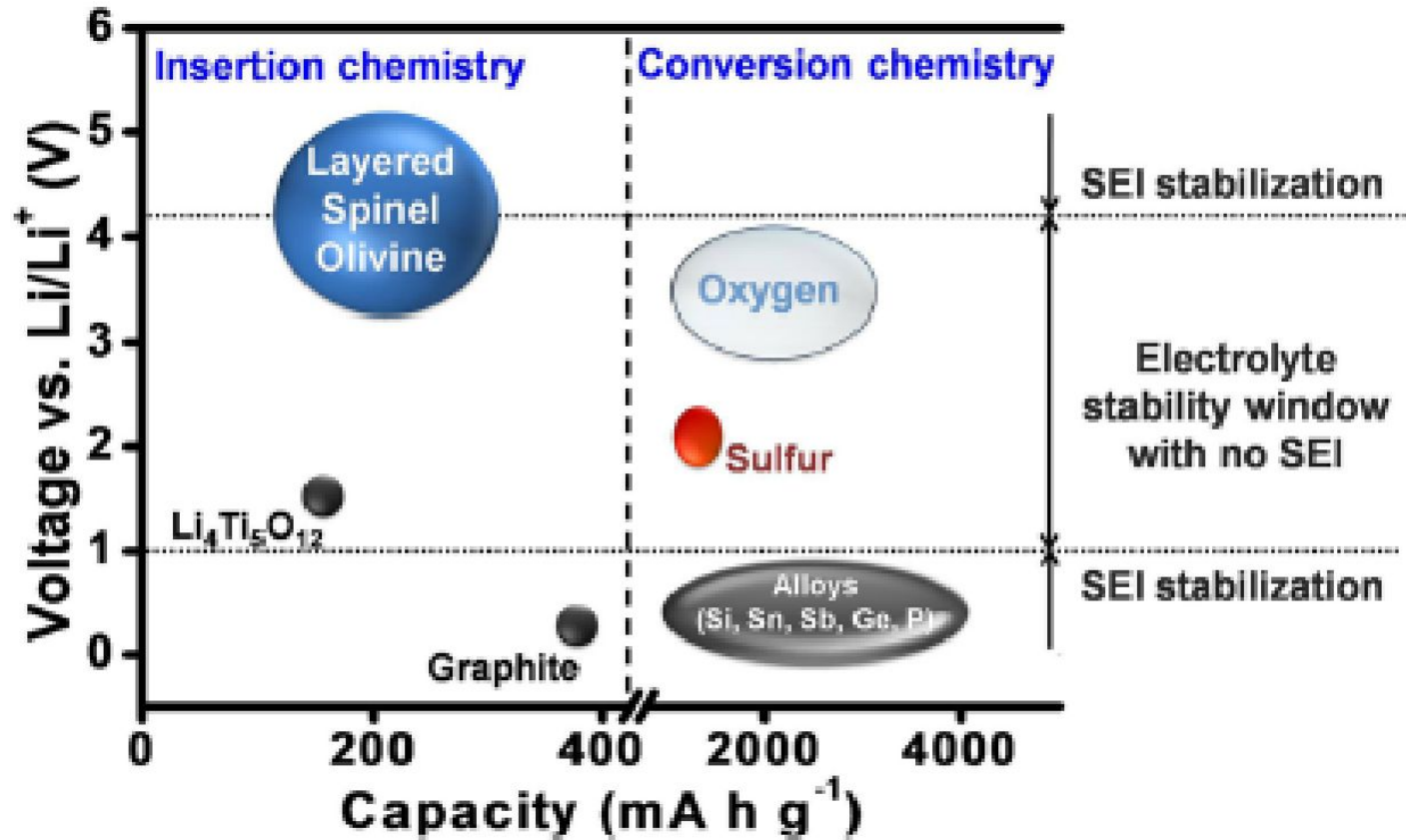



Table 21.2 Selected Standard Electrode Potentials (298 K)

	Half-Reaction	$E^\circ_{\text{half-cell}}$ (V)
	$\text{F}_2(\text{g}) + 2\text{e}^- \rightleftharpoons 2\text{F}^-(\text{aq})$	+2.87
	$\text{Cl}_2(\text{g}) + 2\text{e}^- \rightleftharpoons 2\text{Cl}^-(\text{aq})$	+1.36
	$\text{MnO}_2(\text{s}) + 4\text{H}^+(\text{aq}) + 2\text{e}^- \rightleftharpoons \text{Mn}^{2+}(\text{aq}) + 2\text{H}_2\text{O}(\text{l})$	+1.23
	$\text{NO}_3^-(\text{aq}) + 4\text{H}^+(\text{aq}) + 3\text{e}^- \rightleftharpoons \text{NO}(\text{g}) + 2\text{H}_2\text{O}(\text{l})$	+0.96
	$\text{Ag}^+(\text{aq}) + \text{e}^- \rightleftharpoons \text{Ag}(\text{s})$	+0.80
	$\text{Fe}^{3+}(\text{aq}) + \text{e}^- \rightleftharpoons \text{Fe}^{2+}(\text{aq})$	+0.77
	$\text{O}_2(\text{g}) + 2\text{H}_2\text{O}(\text{l}) + 4\text{e}^- \rightleftharpoons 4\text{OH}^-(\text{aq})$	+0.40
	$\text{Cu}^{2+}(\text{aq}) + 2\text{e}^- \rightleftharpoons \text{Cu}(\text{s})$	+0.34
	$2\text{H}^+(\text{aq}) + 2\text{e}^- \rightleftharpoons \text{H}_2(\text{g})$	0.00
	$\text{N}_2(\text{g}) + 5\text{H}^+(\text{aq}) + 4\text{e}^- \rightleftharpoons \text{N}_2\text{H}_5^+(\text{aq})$	-0.23
	$\text{Fe}^{2+}(\text{aq}) + 2\text{e}^- \rightleftharpoons \text{Fe}(\text{s})$	-0.44
	$\text{Zn}^{2+}(\text{aq}) + 2\text{e}^- \rightleftharpoons \text{Zn}(\text{s})$	-0.76
	$2\text{H}_2\text{O}(\text{l}) + 2\text{e}^- \rightleftharpoons \text{H}_2(\text{g}) + 2\text{OH}^-(\text{aq})$	-0.83
	$\text{Na}^+(\text{aq}) + \text{e}^- \rightleftharpoons \text{Na}(\text{s})$	-2.71
$\text{Li}^+(\text{aq}) + \text{e}^- \rightleftharpoons \text{Li}(\text{s})$	-3.05	

1 H	
3 Li	4 Be

Periodic Table of the Elements

- hydrogen
- alkali metals
- alkali earth metals
- poor metals
- nonmetals
- noble gases

© www.elementsdatabase.com

				2 He
5 B	6 C	7 N	8 O	9 F
				10 Ne

Li-ion Battery: Working Principle

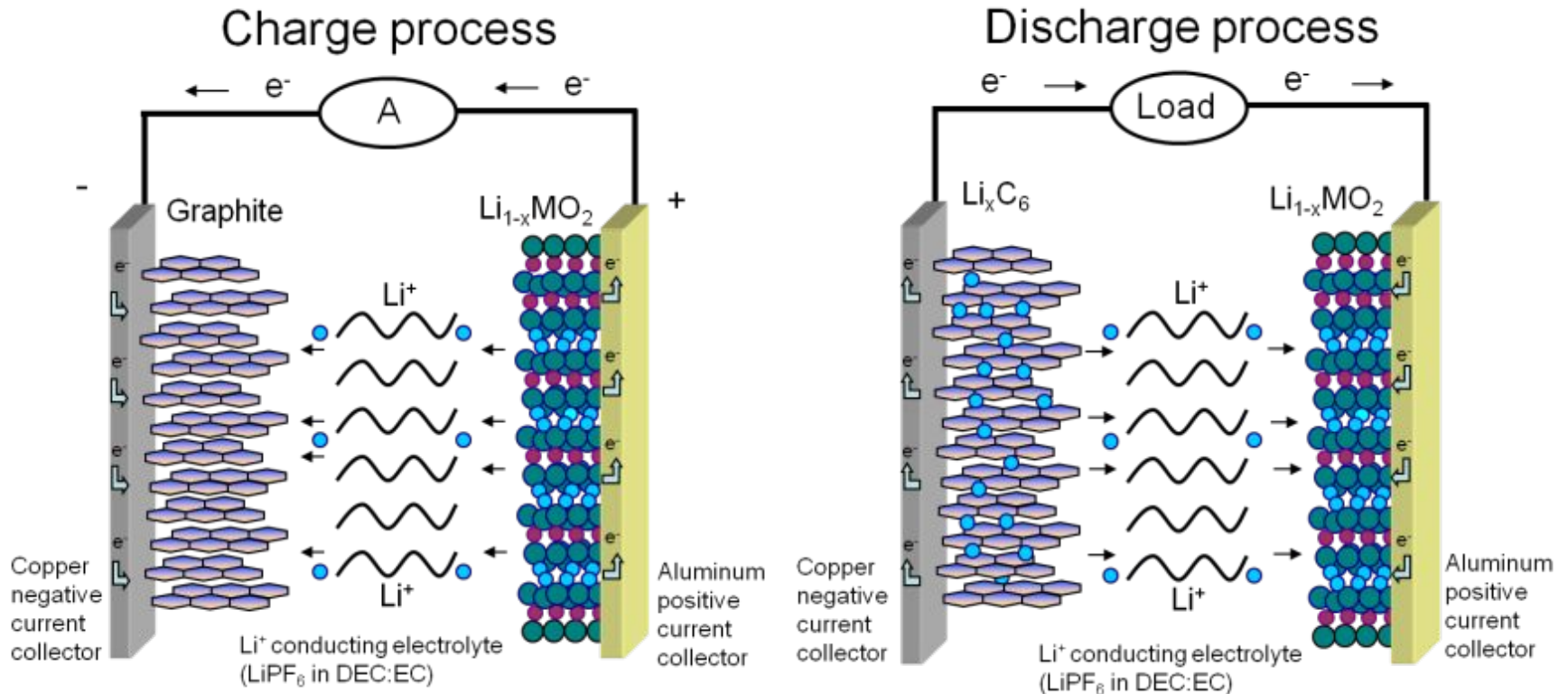

LiC₆ Negative Electrode (Sony 1990)

- Which (negative) electrode materials are used?

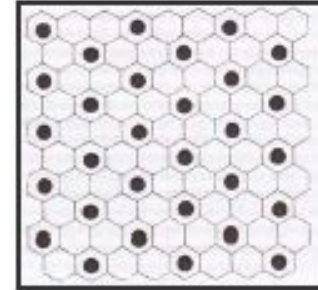
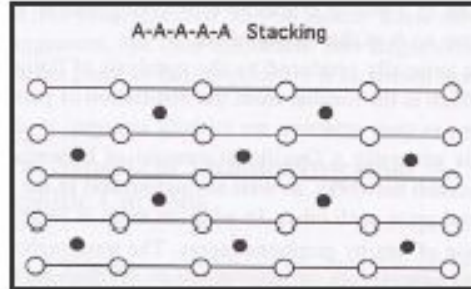
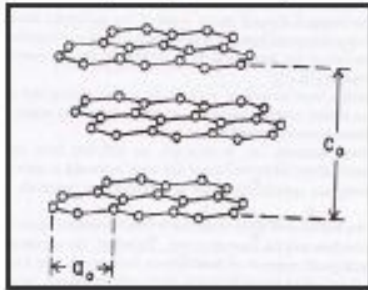

discharged



charged

Anode

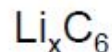
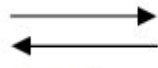
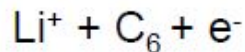

$$x < 1$$

$$1.0 \text{ V} < E^0 < \sim 0.05 \text{ V vs. Li}$$

Cathode

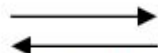
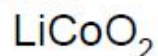

$$x < 0.5$$

$$3.5 \text{ V} < E^0 < \sim 4.25 \text{ V vs. Li}$$

Charge: Coulomb

Current: Coulomb/sec=Ampere

1 gram mole has $N_A = 6.022 \times 10^{23}$ molecules

Li-ion Battery Materials

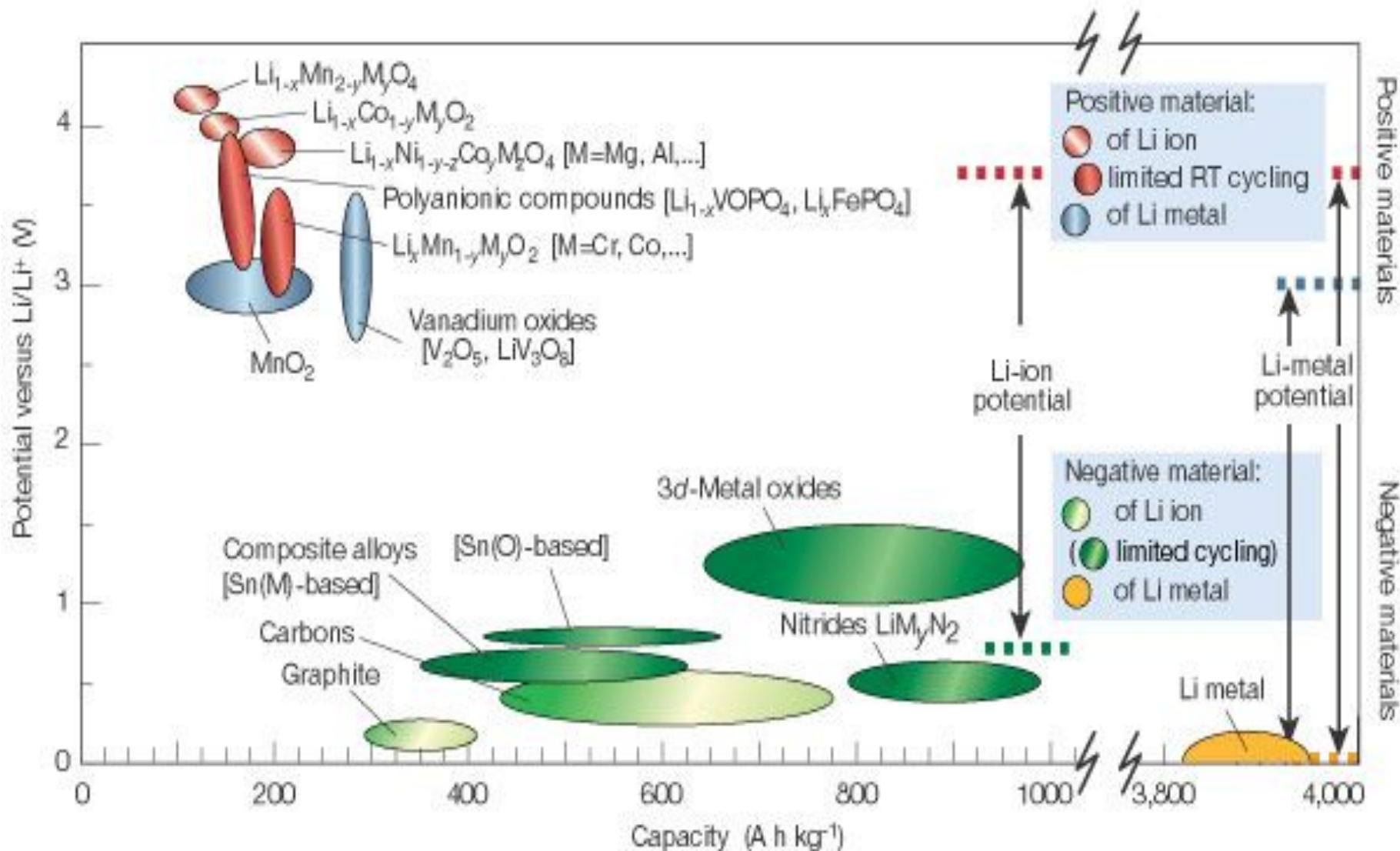

Between all Li-metal alloys, Li-Si and Li-Sn are the more interesting . . .

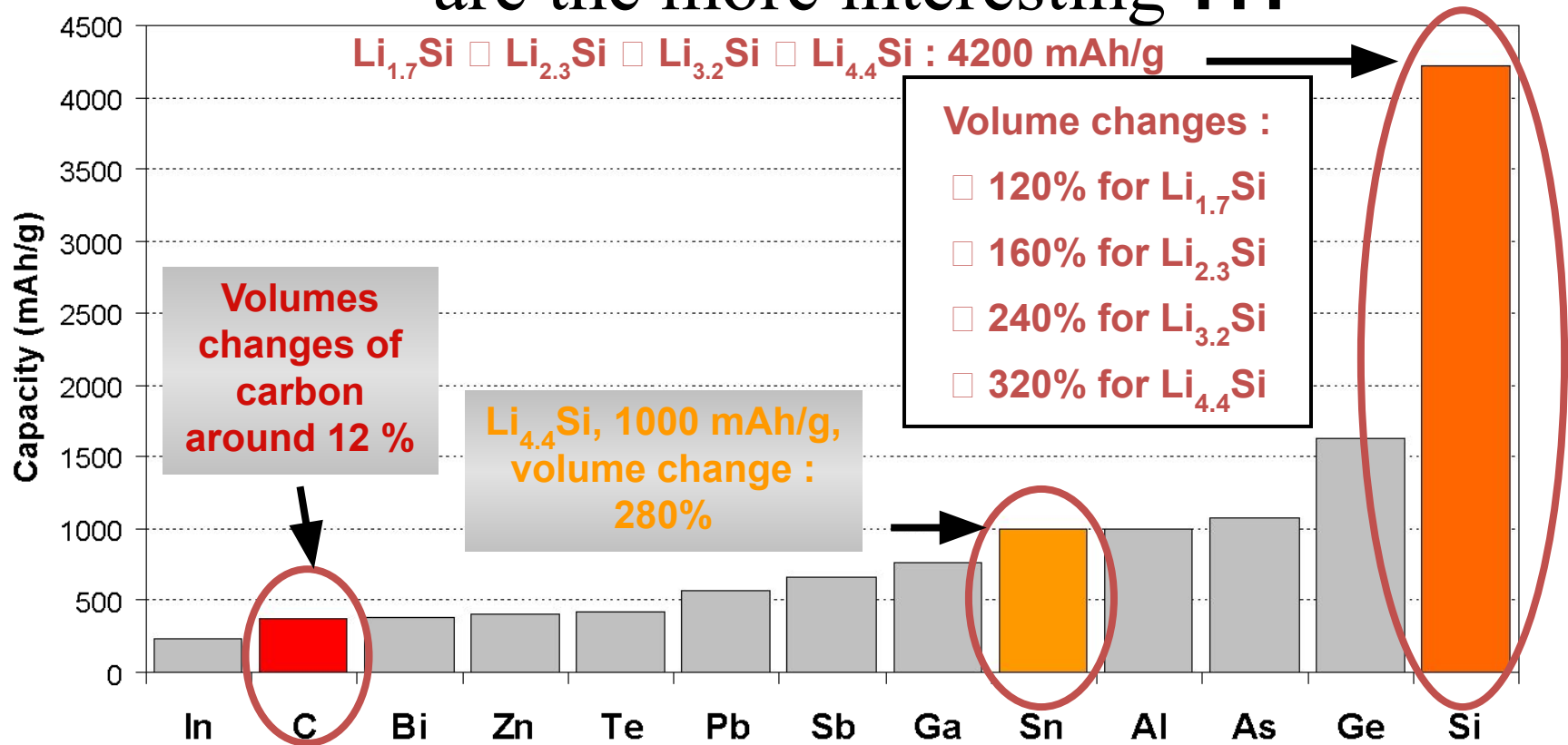

Challenge: find a mean to contain Li_xM_y volume changes on charge / discharge and to improve consecutive capacity loss on cycling :

- Nano-sized particles & Electrode structuration ;
- Limit the insertion in the case of Si : $\text{Li}_{1.7}\text{Si}$ (1600 mAh/g).

Which (negative) electrode materials are used?

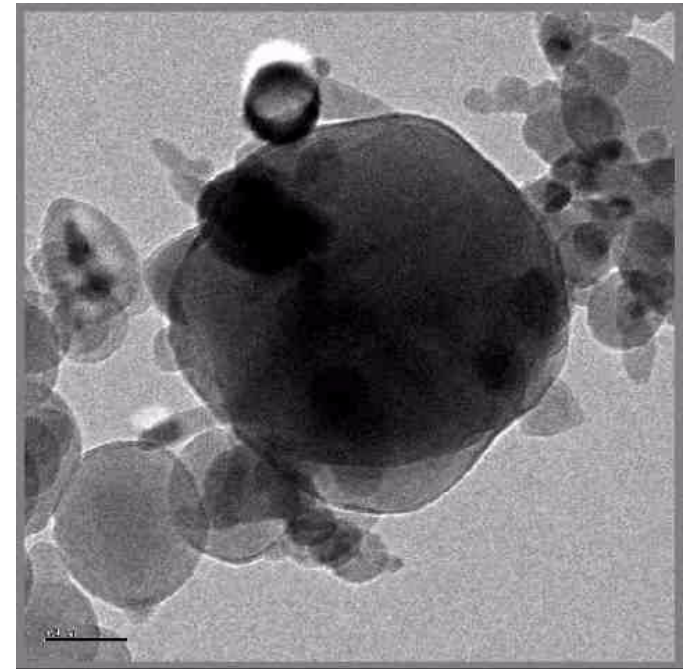
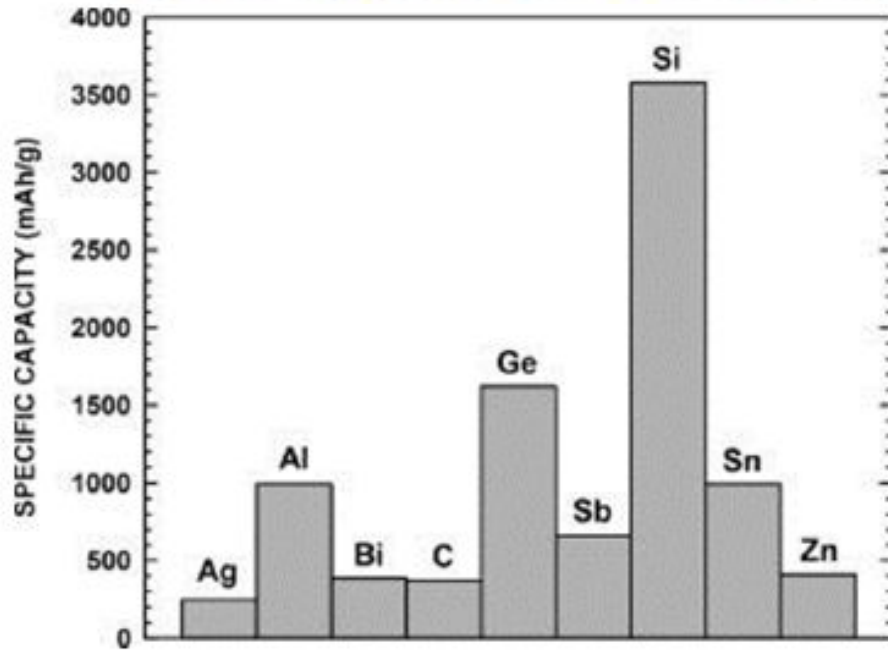

Si has the highest specific capacity.

Materials such as Si and Sn show large capacities compared to graphite.



These materials have very large volume change, which results in the destruction of the electrode on lithiation

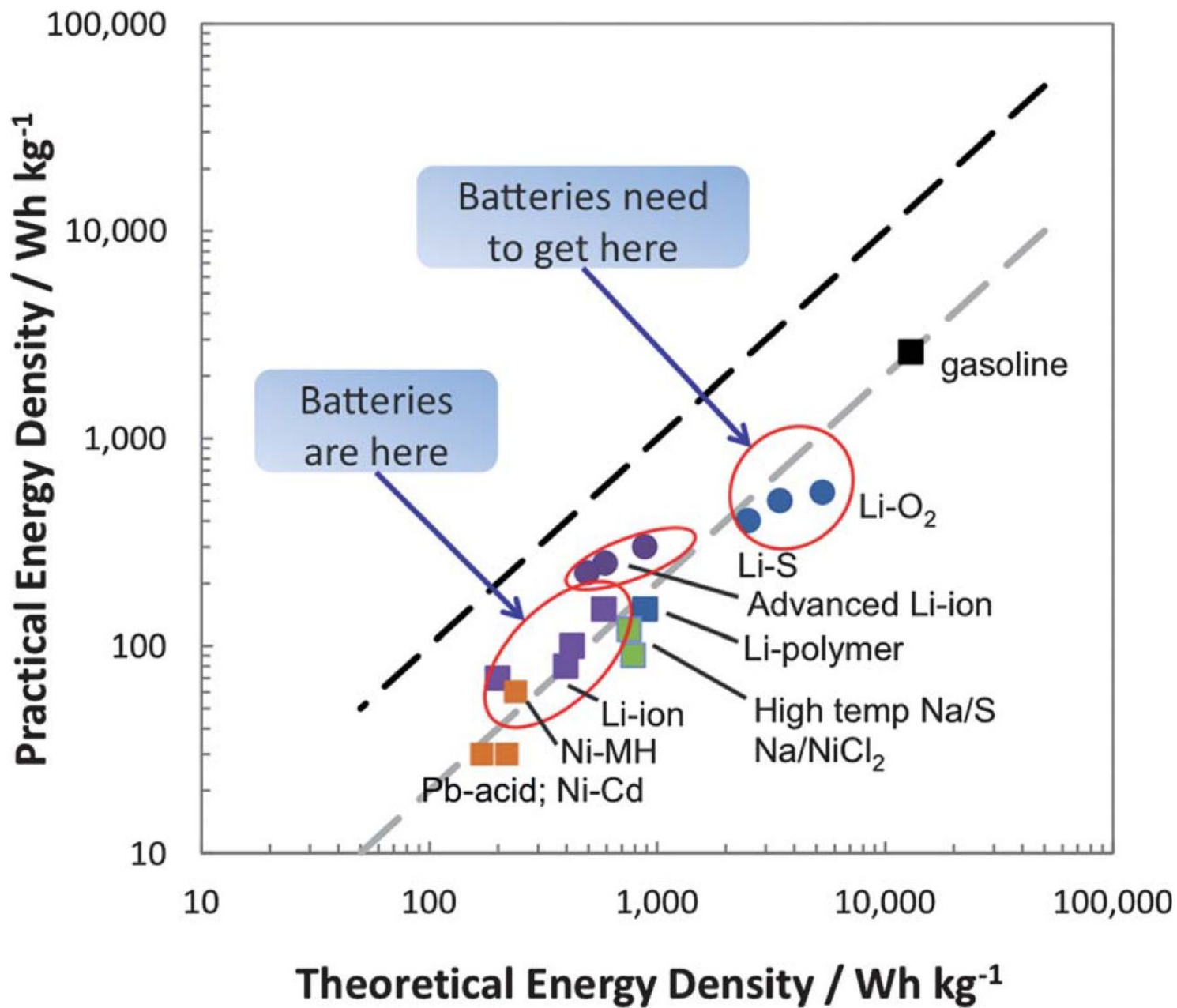

Beyond lithium-ion

Negative materials

Exchanging more than electron per mole (Mg, Al)

Lithium air 100 Wh/kg ?

Lithium- sulfur
300 Wh/kg ?

Low cost sodium batteries ?

Use of bio renewable materials

Li-S Batteries

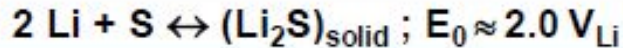
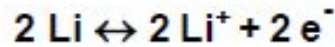
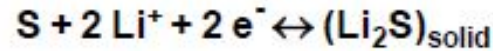

Sulfur capacity $\sim 1600 \text{ mAh/g}$

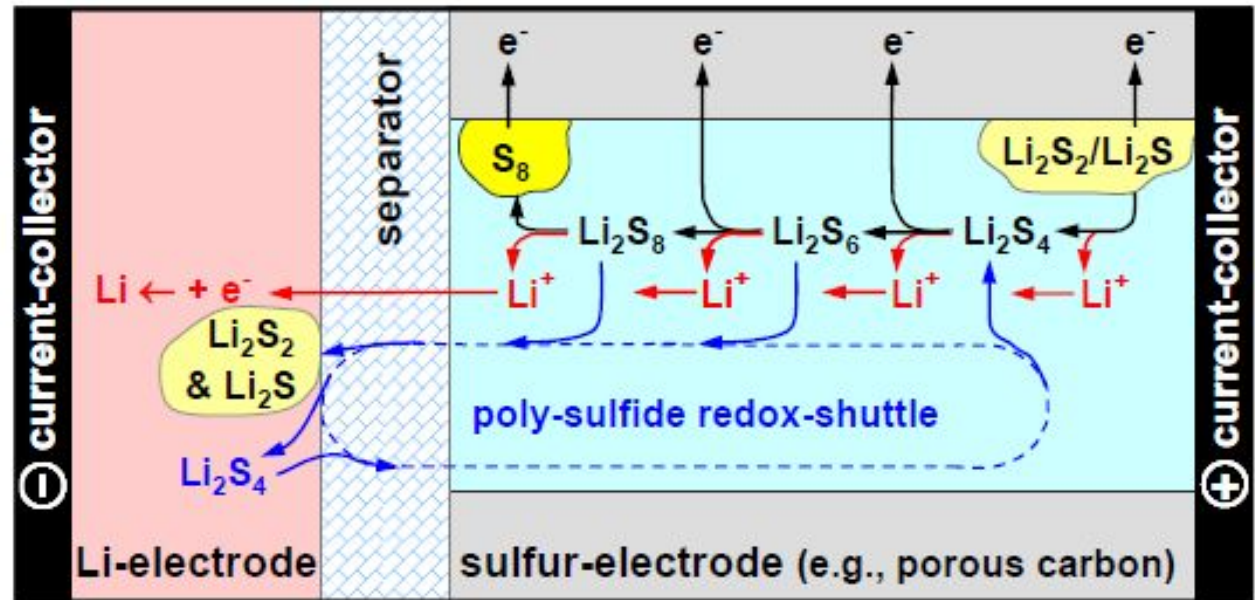

challenges & development needs:

- polysulfide diffusion to anode → Li^+ -conducting diffusion-barrier
- poor C-rate & cathode "clogging" → cathode design
- stable anode configuration → improved Li-metal anode design or alternative

Flow Batteries

- Flow batteries use pumped electrolytes that move outside of the battery case
 - Polysulfide Bromide (PSB), Vanadium Redox (VRB), Zinc Bromine (ZnBr), and Hydrogen Bromine (H-Br) batteries are examples
- A “filling station” could exchange spent electrolyte for new “charged” electrolyte
- The power and energy ratings are thus independent since the power is from the battery electrodes while the electrolyte may be replaced periodically

Flow Battery

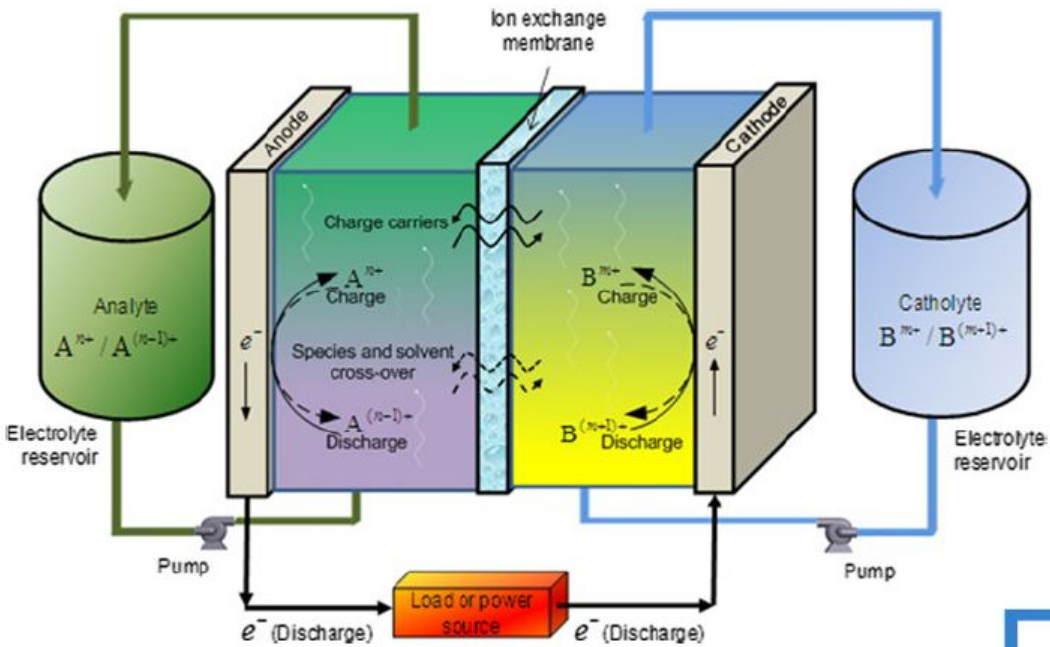

Charge Reaction:

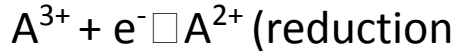
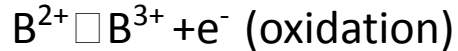

Discharge Reaction:

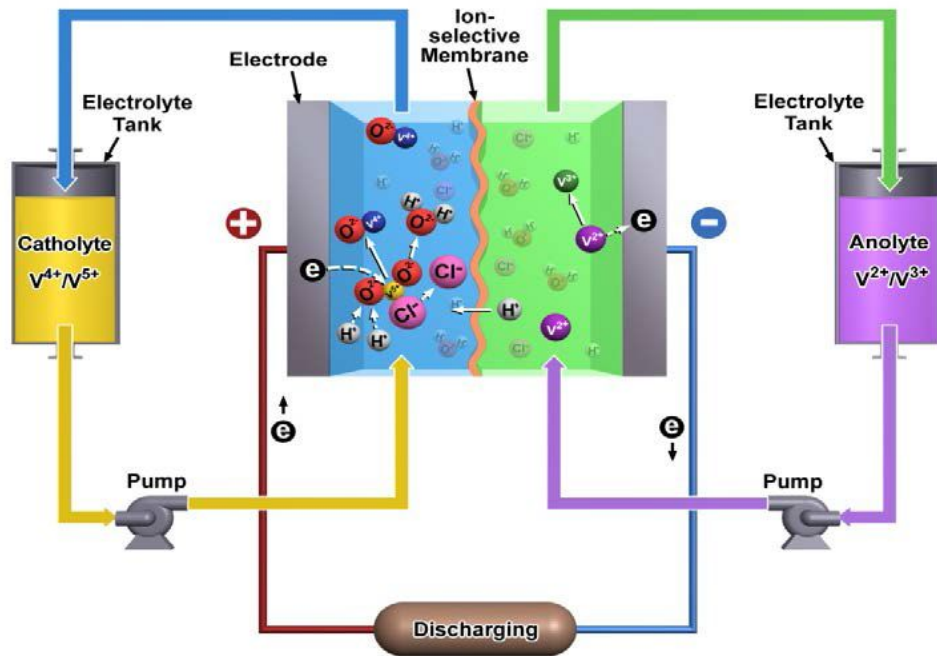
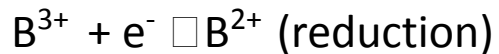

EXAMPLES OF REDOX FLOW BATTERY CHEMISTRIES

Couple	Cell Rxs	Half-cell E°	E°
Fe/Cr	Fe^3/Fe^2 Cr^2/Cr^3	.77 -.41	1.18
V/V	$\text{VO}_2^+/\text{VO}^2$ V^2/V^3	.99 -.26	1.25
Fe/Ti	Fe^3/Fe^2 Ti^3/TiO^2	.77 .1	.67
Br/S	$\text{Br}_3^-/3\text{Br}^-$ $2\text{S}_2^{-2}/\text{S}_4^{-2}$	1.09 -.266	1.356
Fe/V	Fe^3/Fe^2 V^2/V^3	.77 -.26	1.03
Br/V	$\text{Br}_3^-/3\text{Br}^-$ V^2/V^3	1.09 -.26	1.35

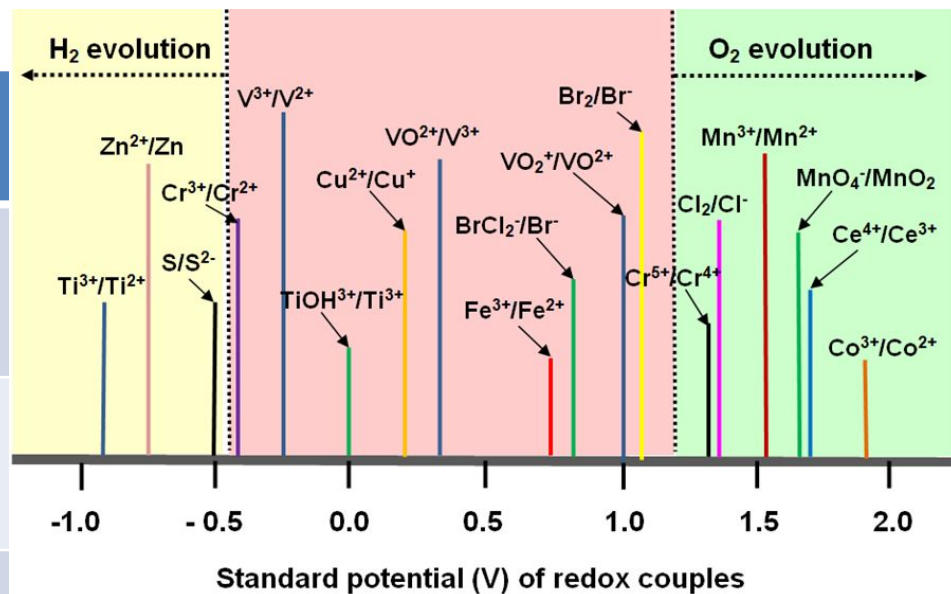

Landscape of Energy Storage Technologies

