



Электрическое оборудование вагонов

81-765/766/767

Альбом фотографий электрического оборудования вагонов для сдачи экзамена по профессии «Машинист электропоезда».

Составитель Кулецкий А.Н. V.10-20.



Подвагонное оборудование вагона 81-765.

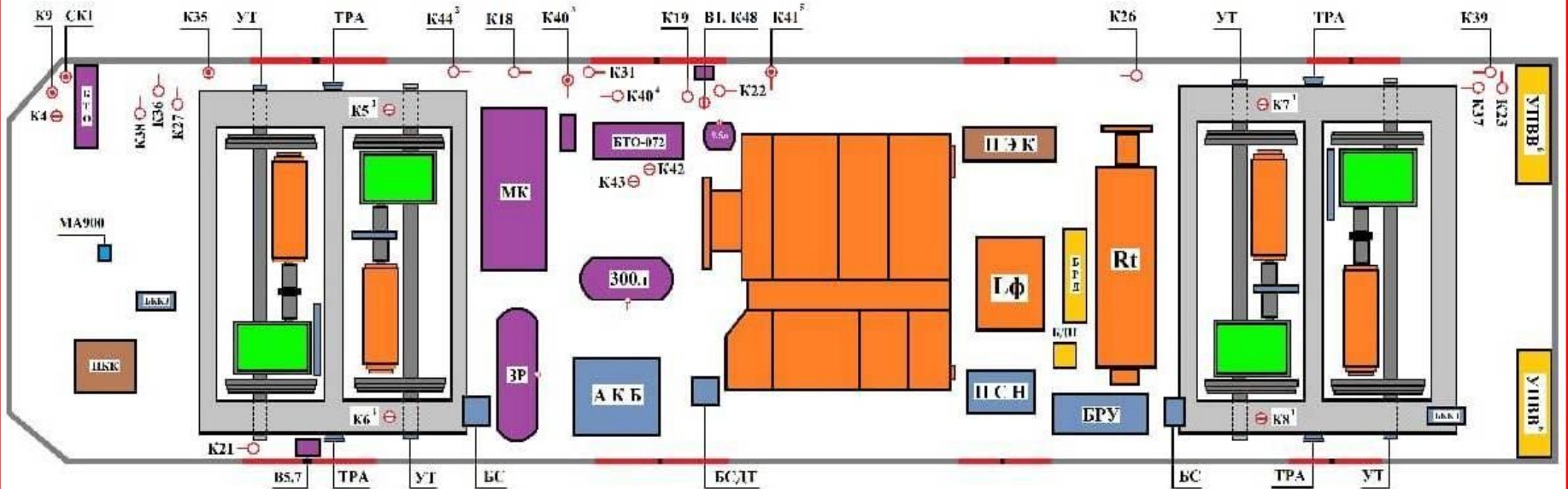
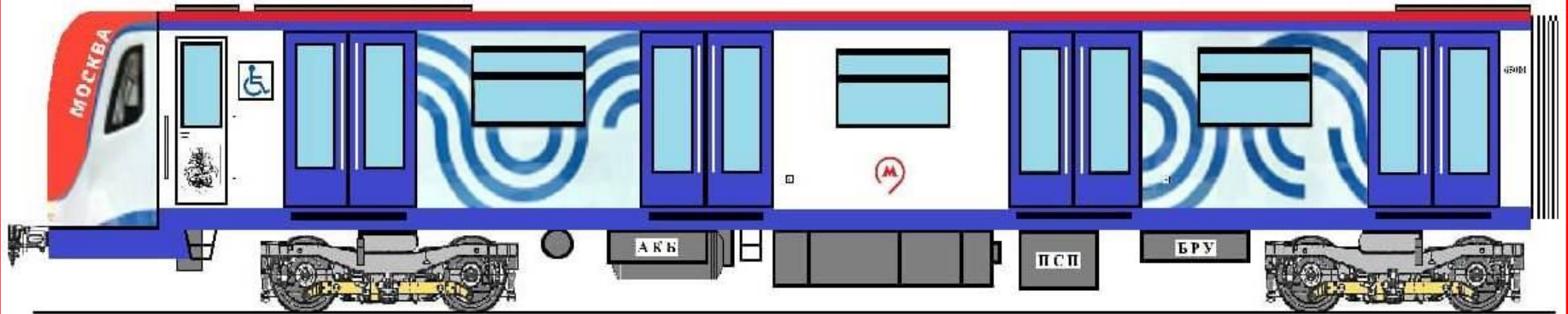

Подвагонное оборудование вагона 81-766.

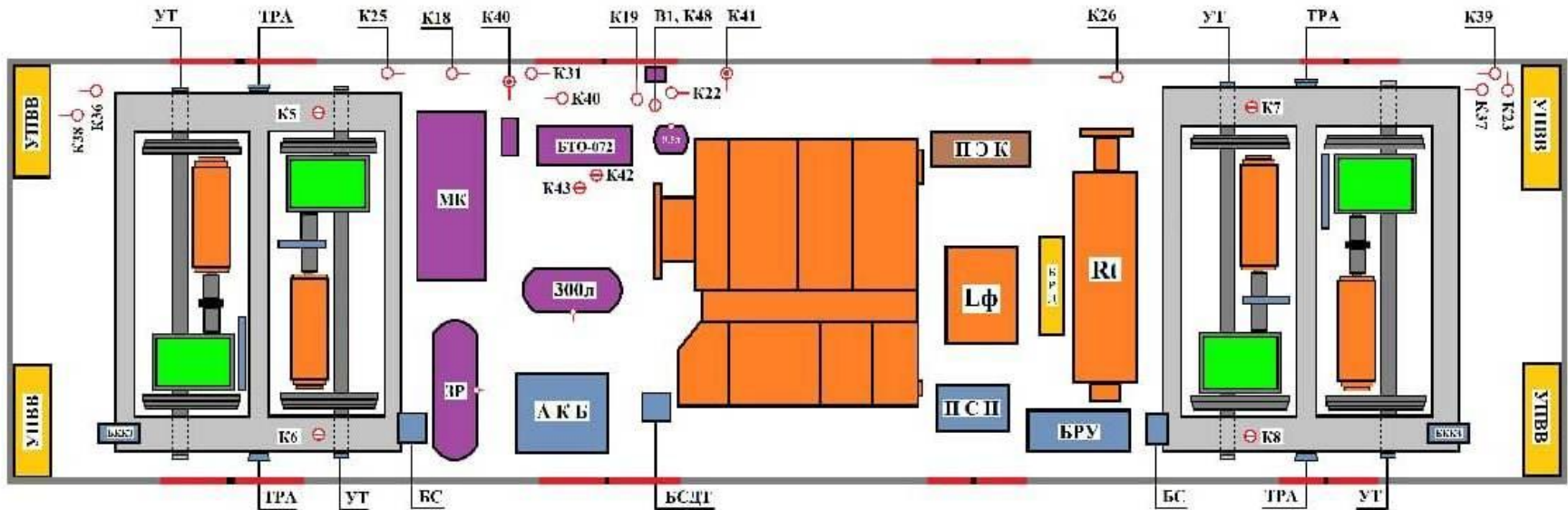
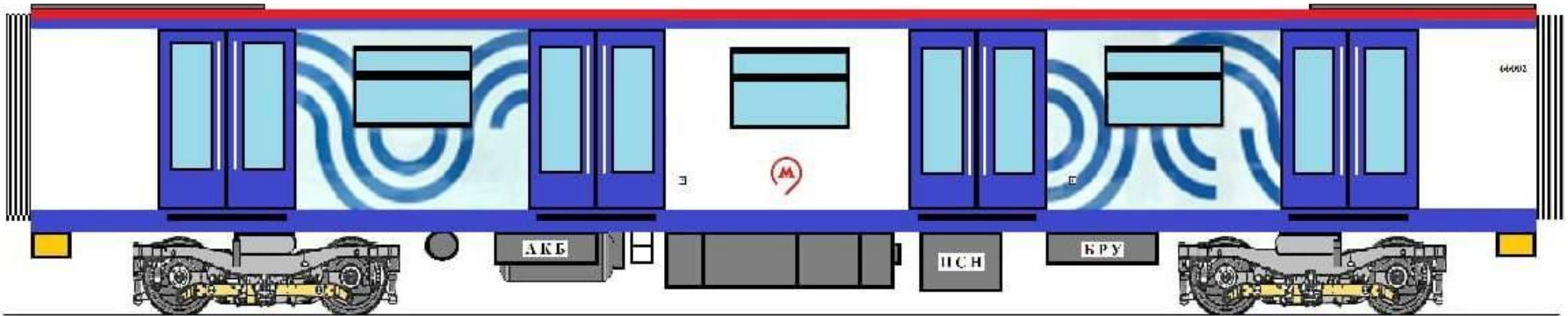

Подвагонное оборудование вагона 81-767.

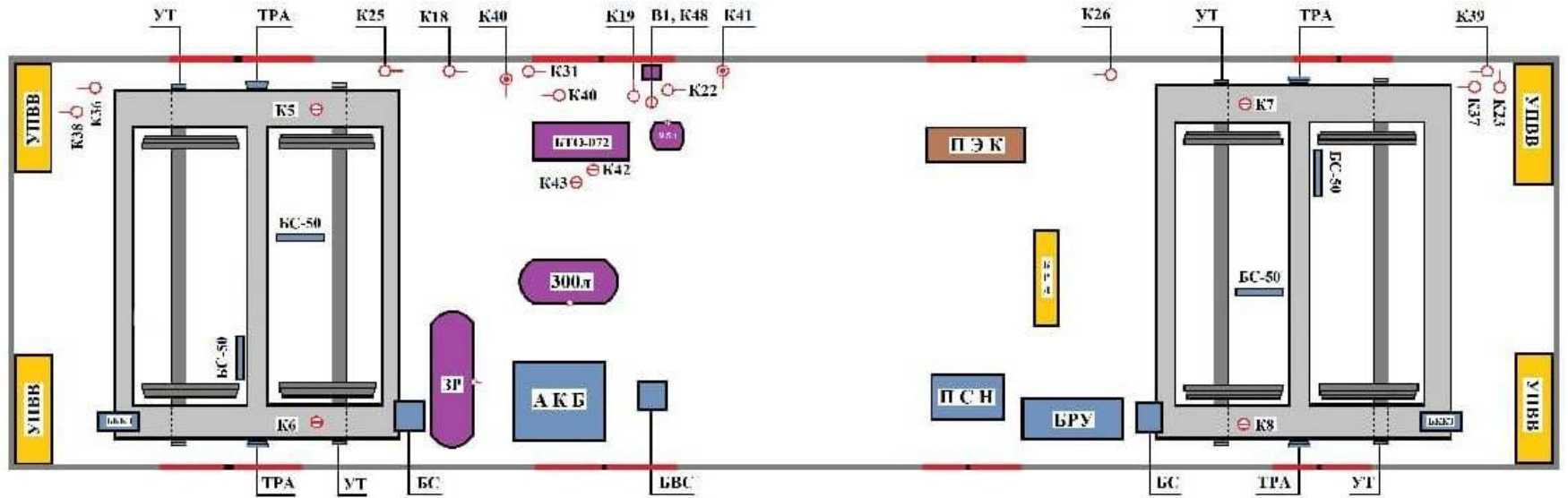
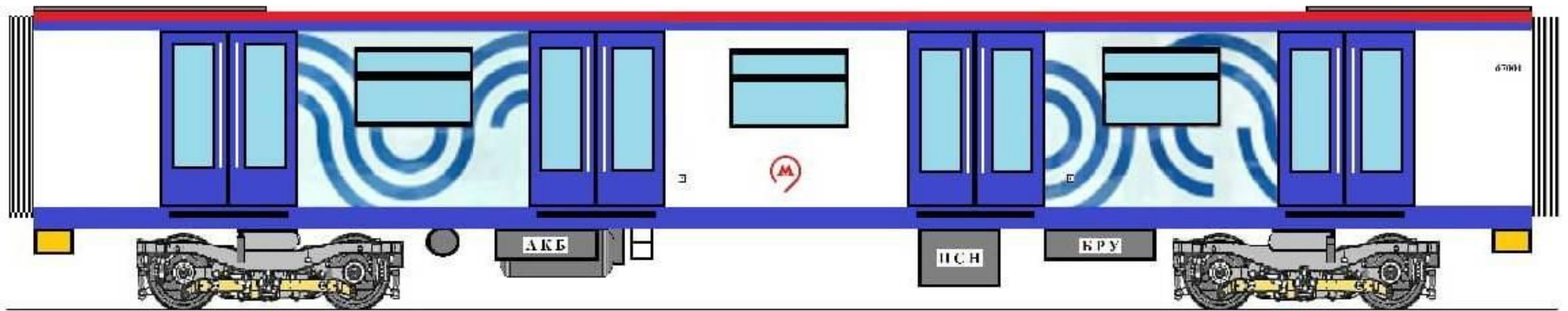

Кабина управления.



Пульт машиниста основной.

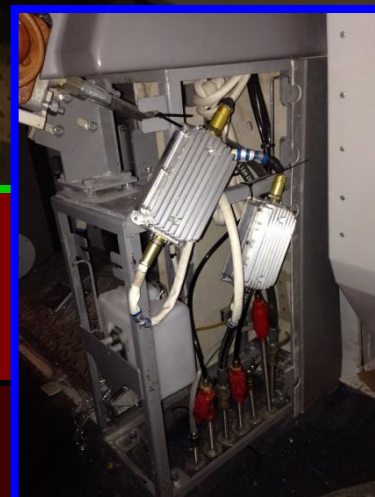

Контроллер машиниста.



Контроллер машиниста «Alfa Union».

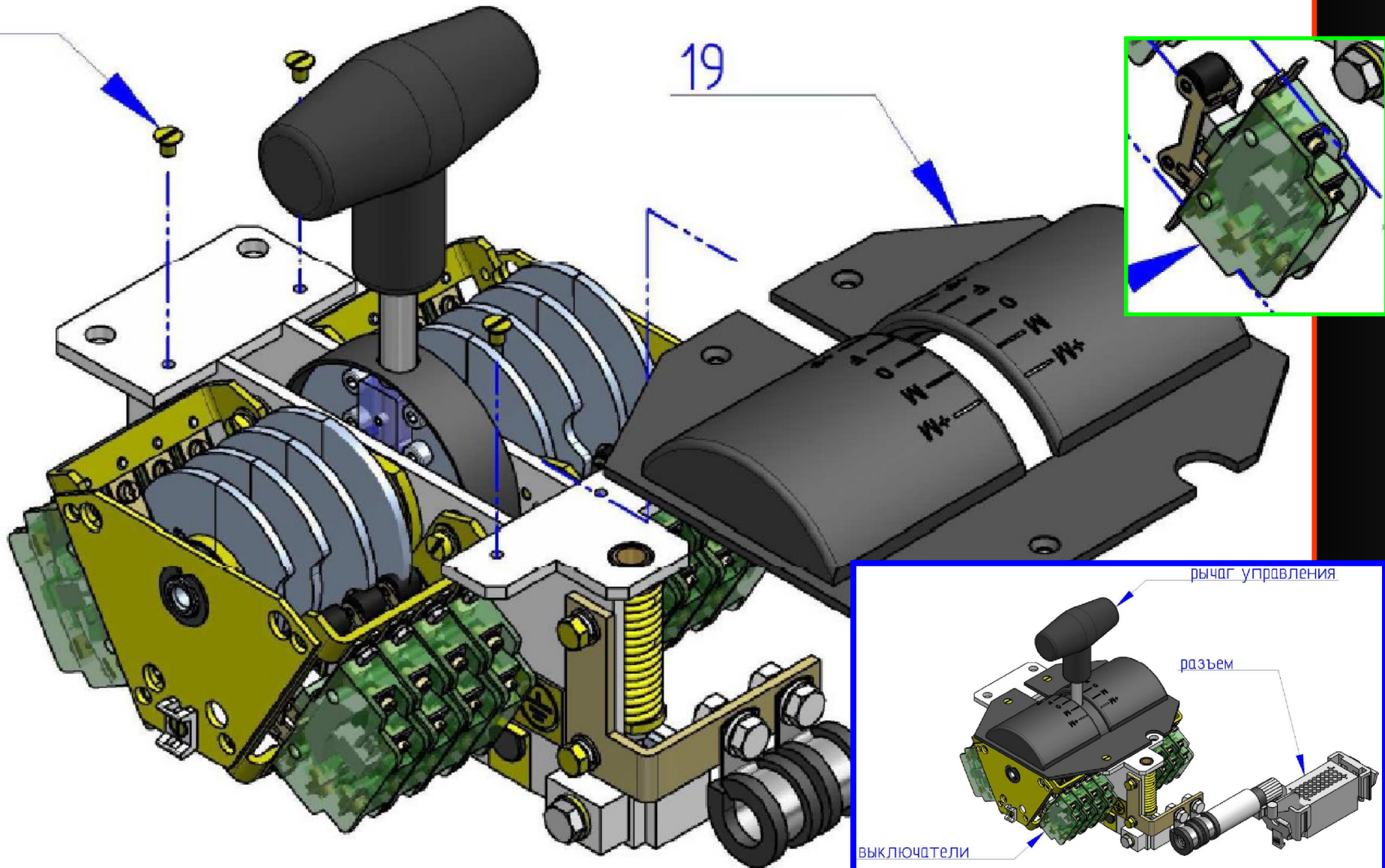

Аппаратный отсек

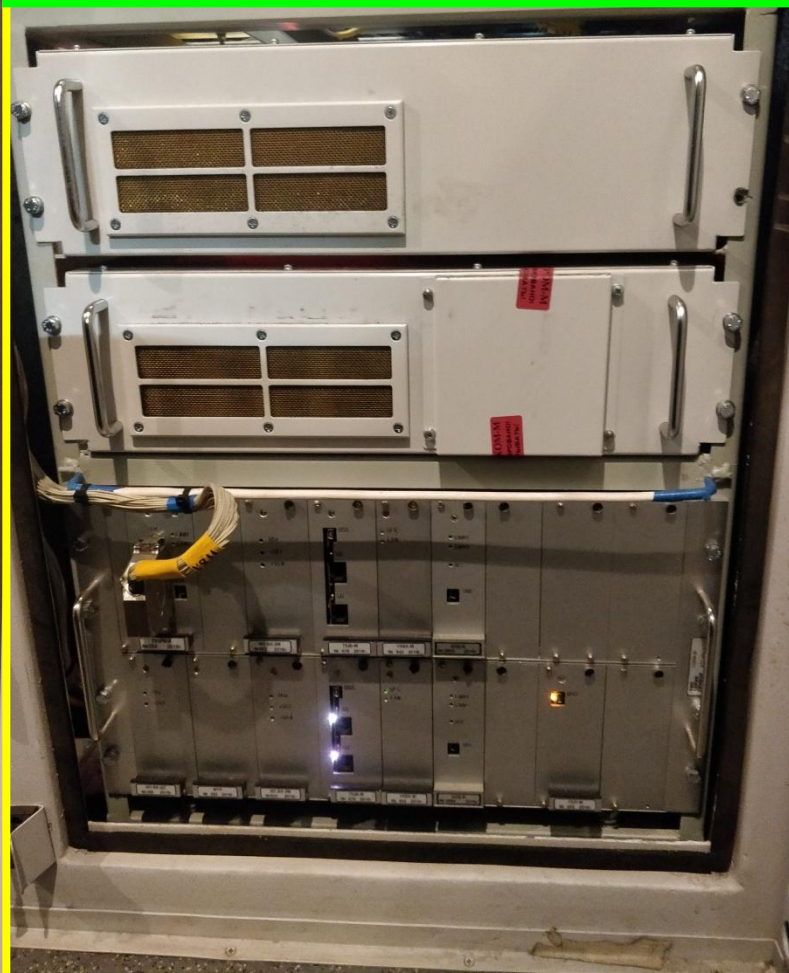

Аппаратный отсек МПИС, РПДП, МУГС, РЛСМ БПФ, РПСР.

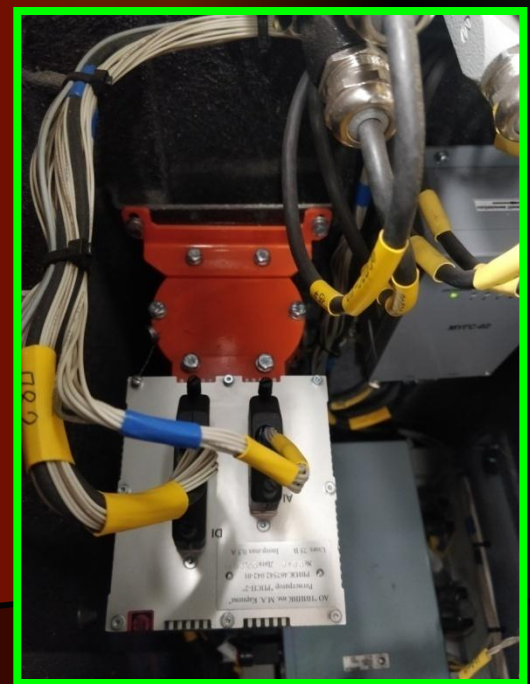

Пульт машиниста вспомогательный.

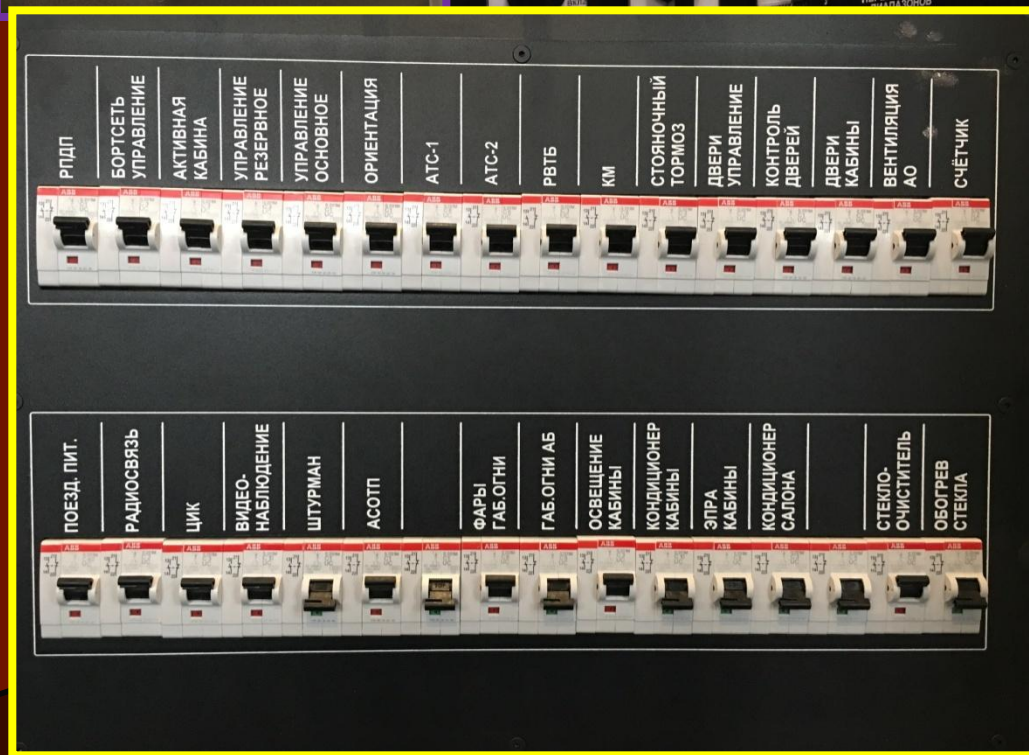
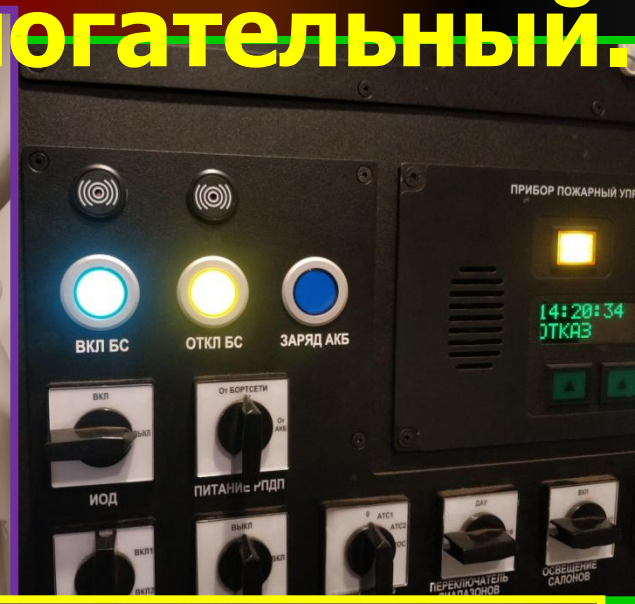
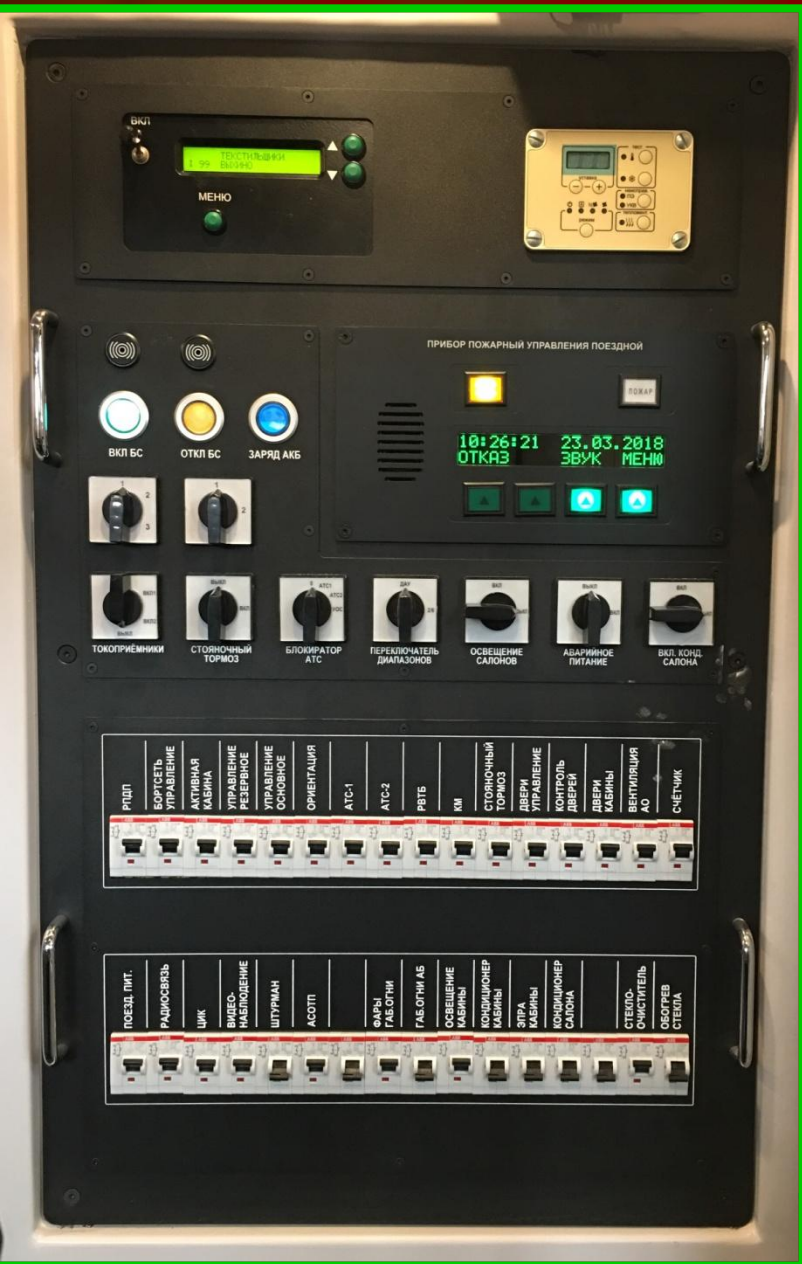

Панель коммутации.



Противоюзная защита.

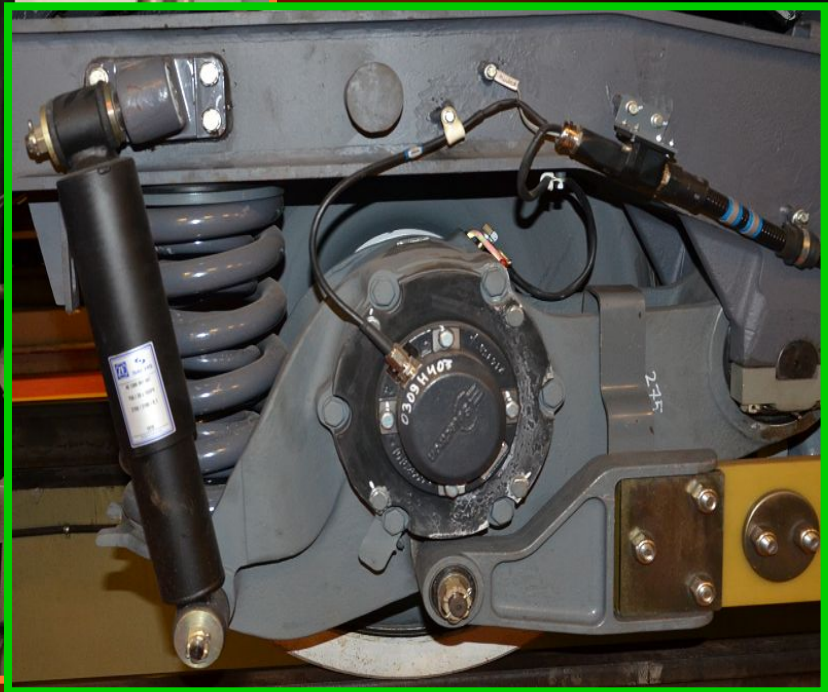
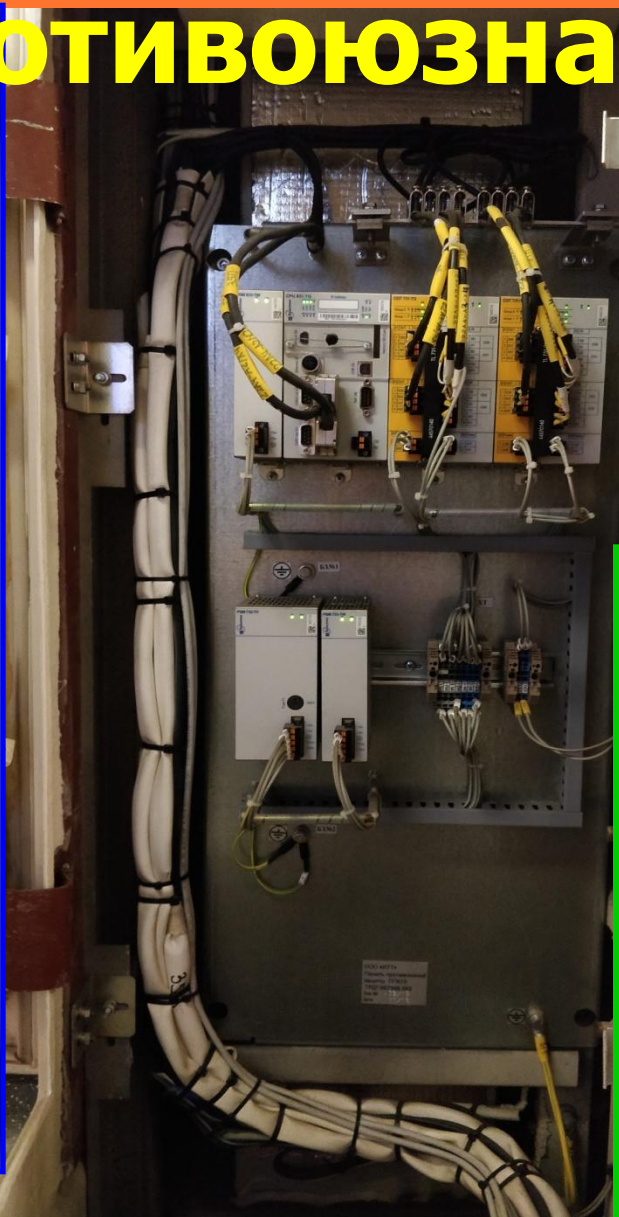

Панель вагонная, БУВ-С.

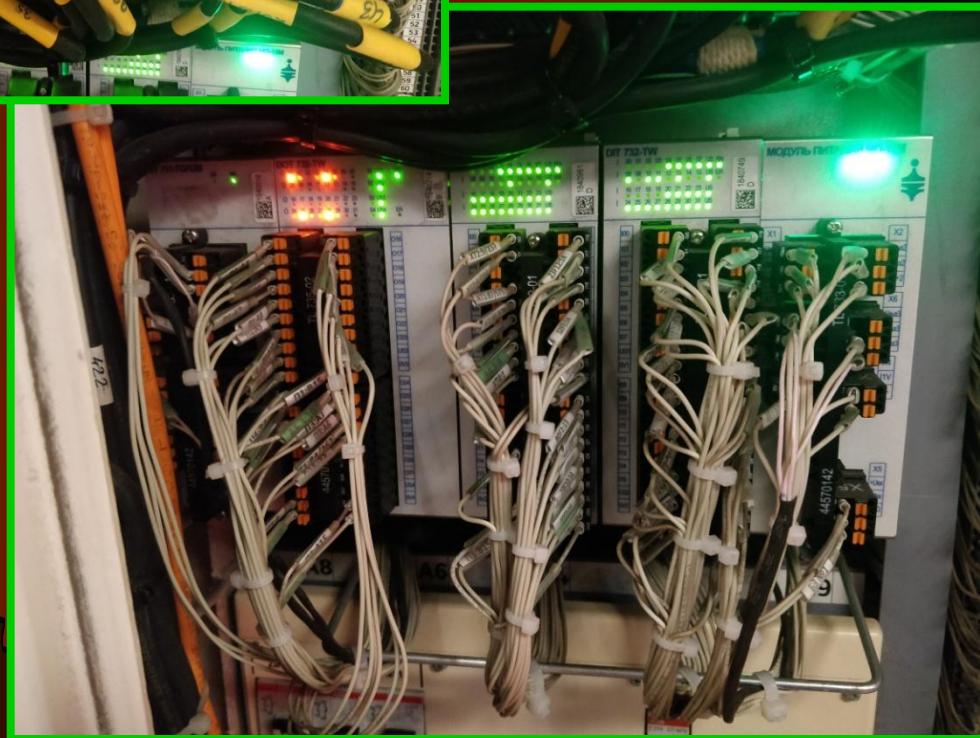
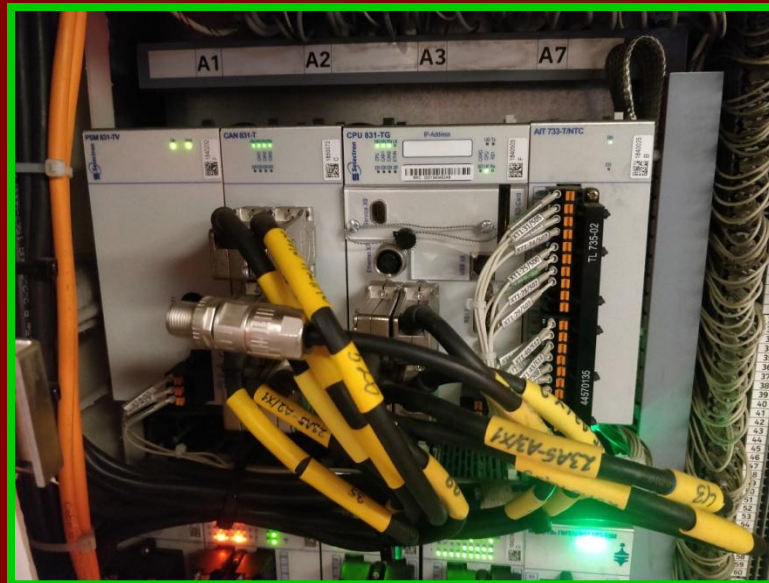

Панель управления вагоном.

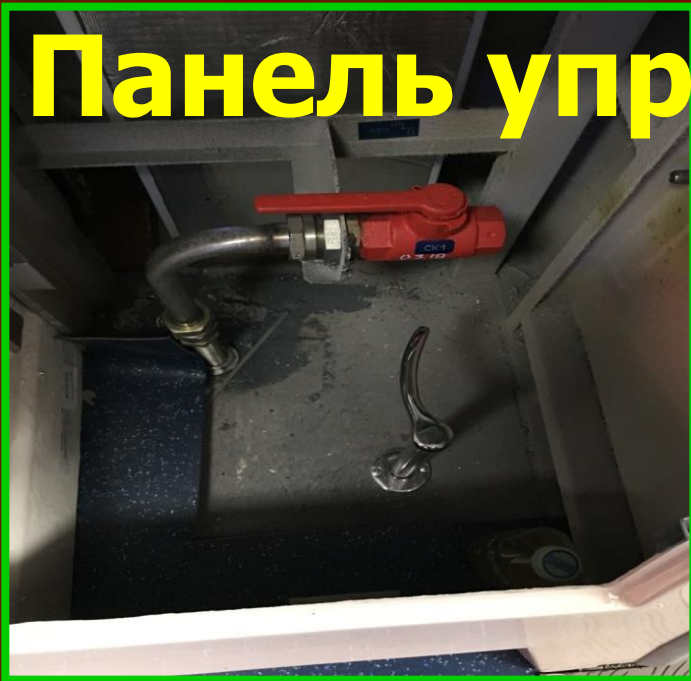

Шкаф с краном машиниста



Фары и габаритные огни.



Система обеспечения климата (СОК-ВМ).



Освещение салона.



Контейнер тягового инвертора.

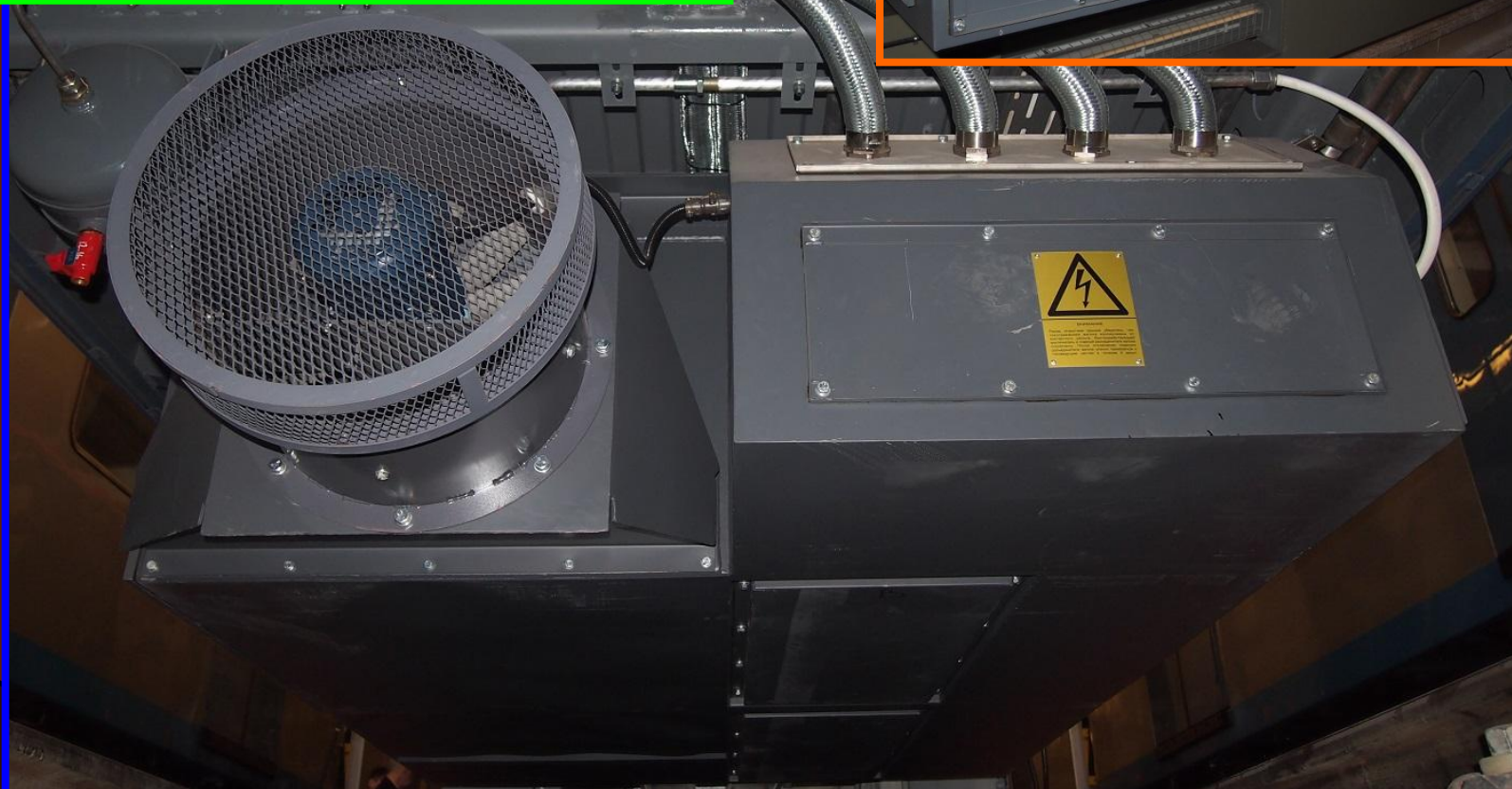

КТИ 3 открытые отсеки.

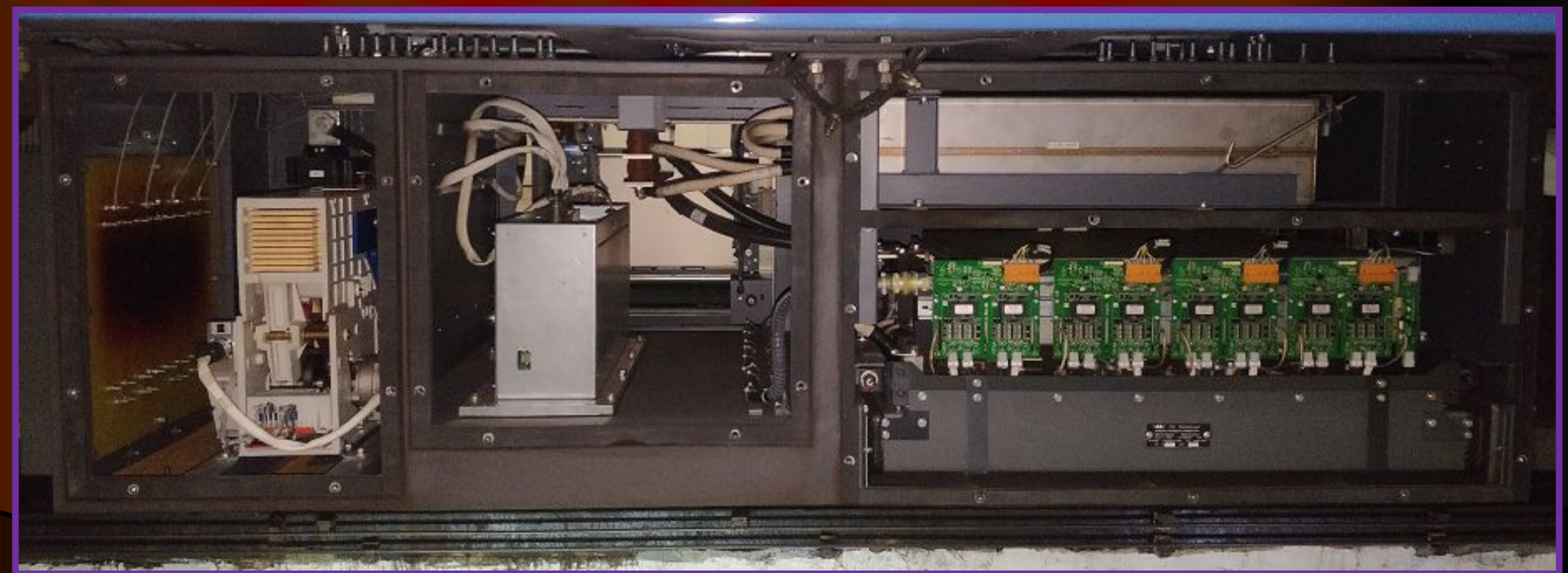
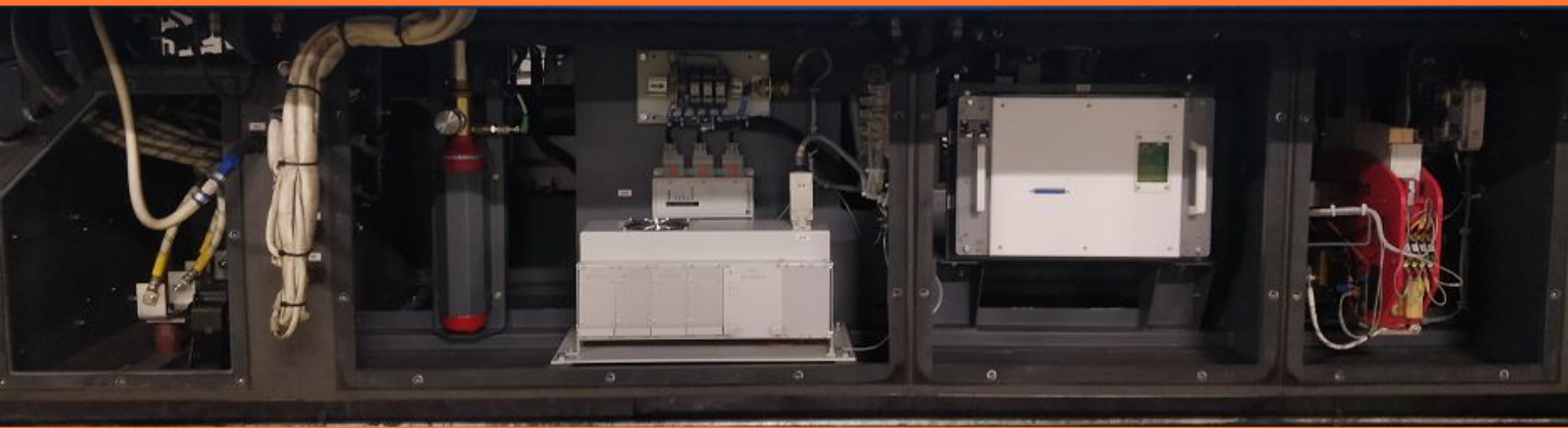

Отсек №1. Контакторов.

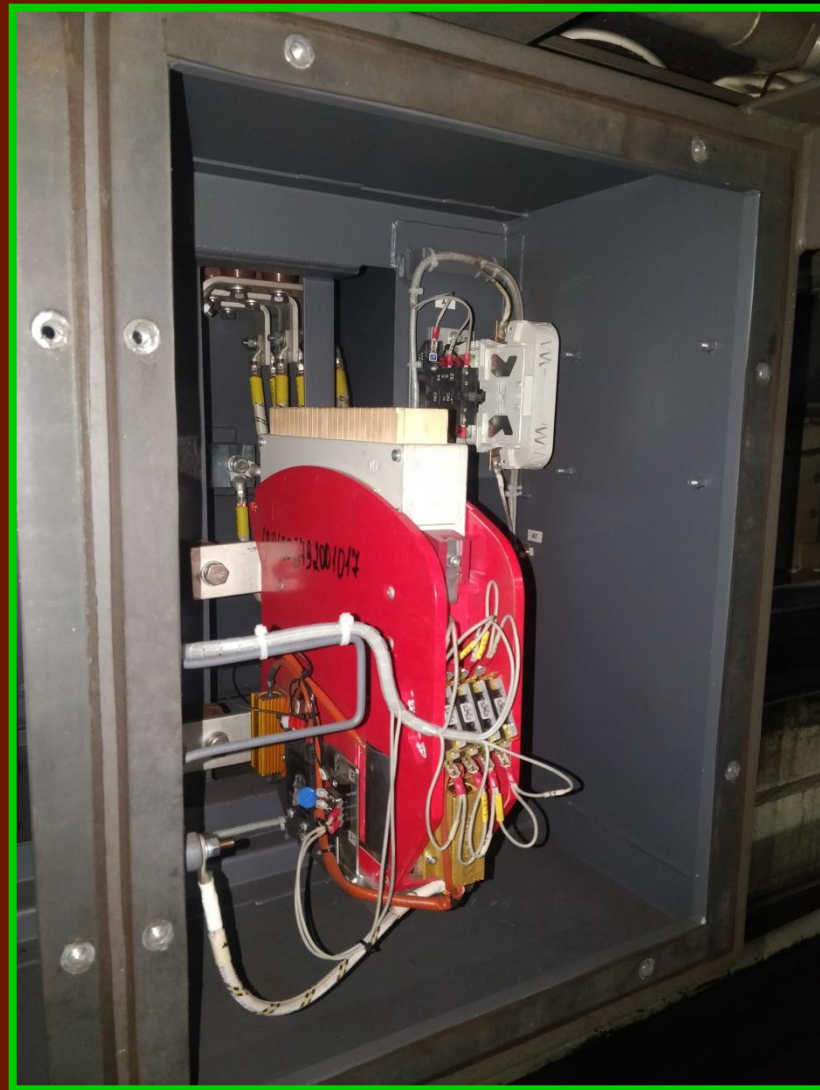
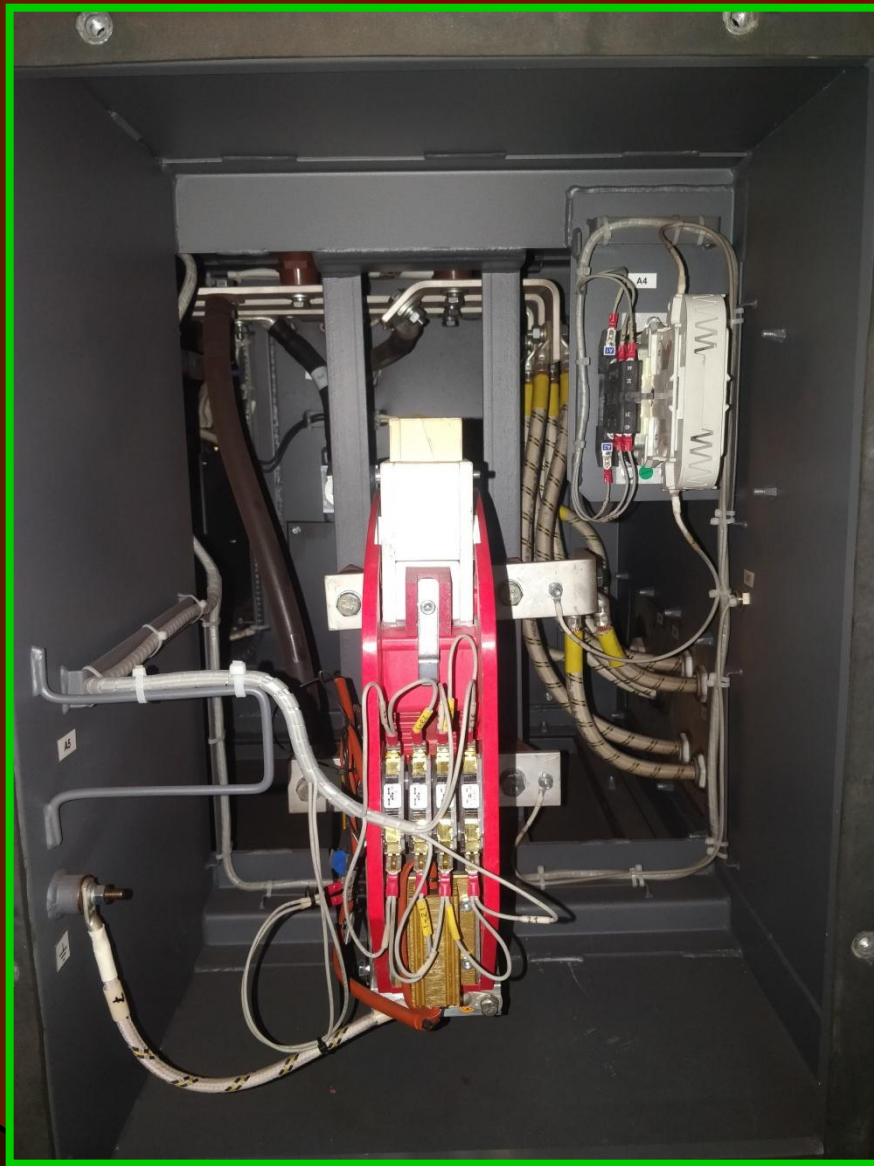

Зарядный контактор LTC-250.



Зарядный резистор.

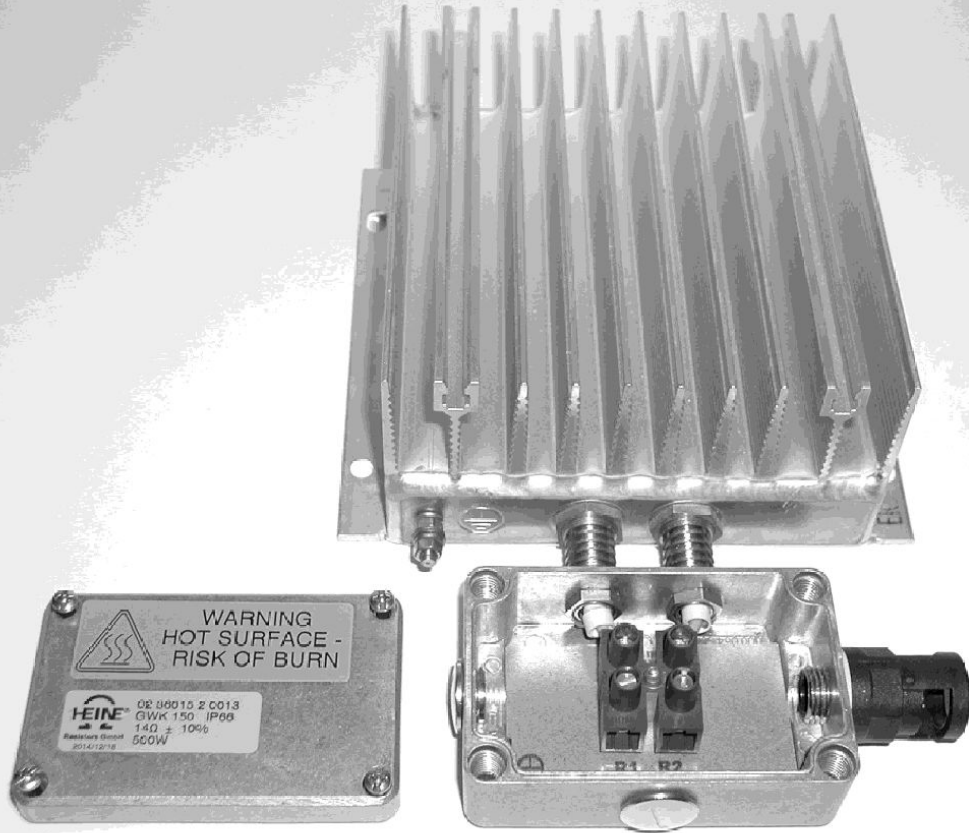

Отсек №2. Блока управления ТЯГОВЫМ ПРИВОДОМ.

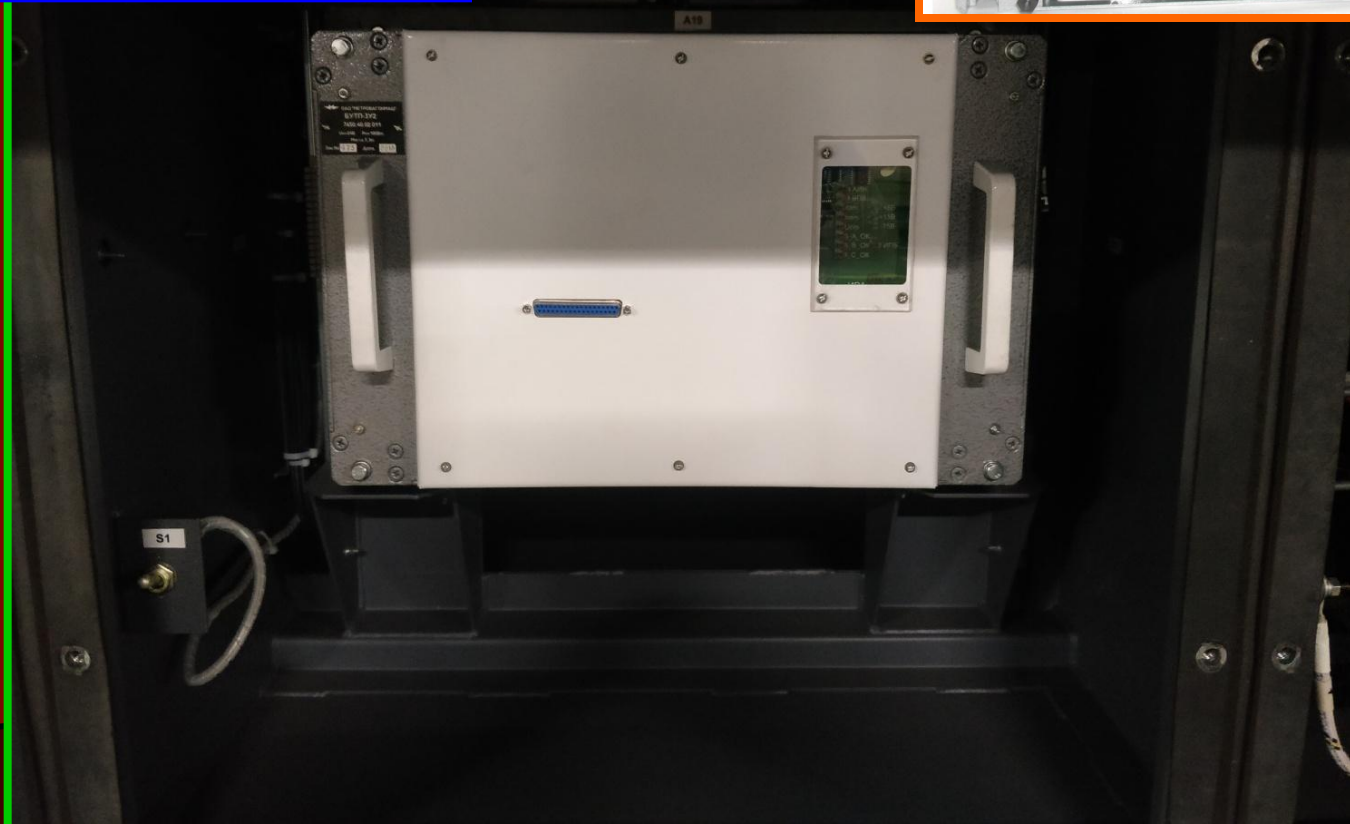
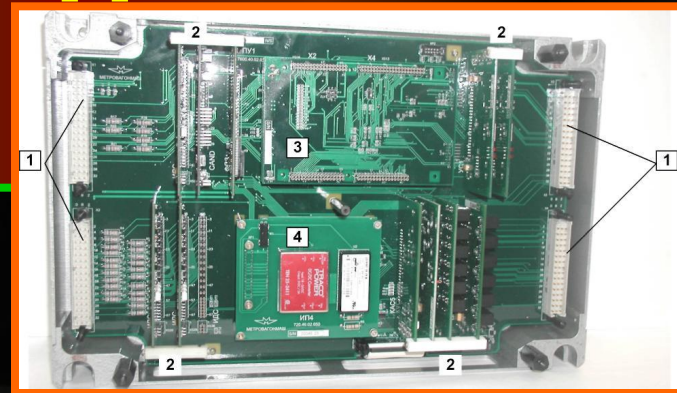

Отсек №3. Вторичного электропитания.

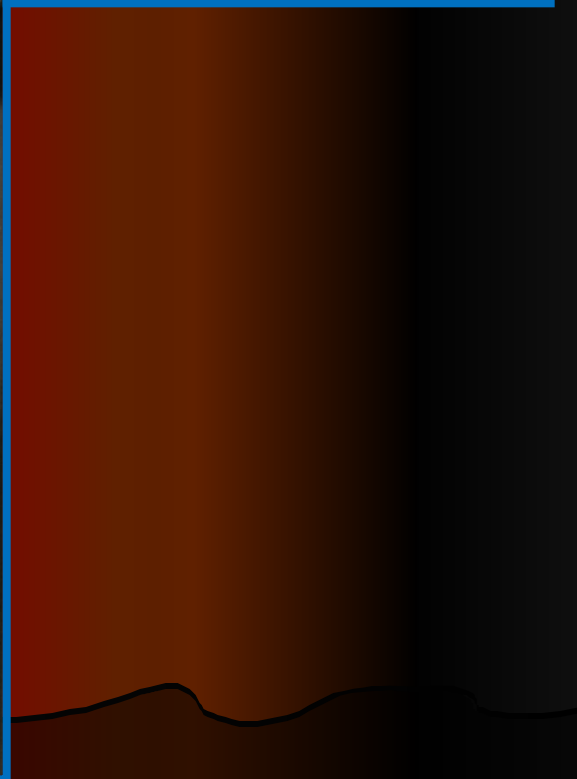
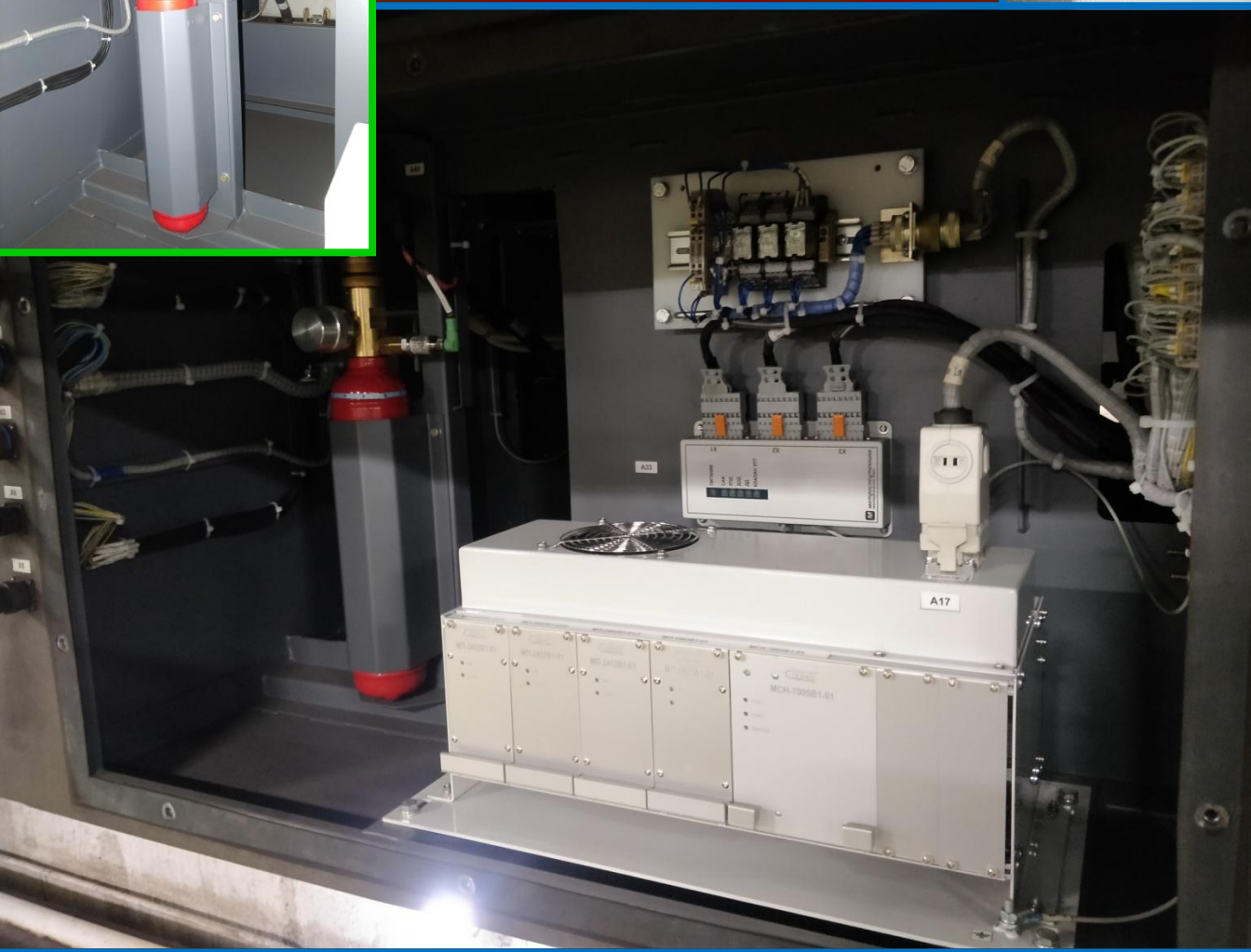

Отсек №4. Датчиков тока.



Отсек №5. Модуля силового инвертора.



Отсек №6. Блока инверторов питания вентиляторов (БИПВ).

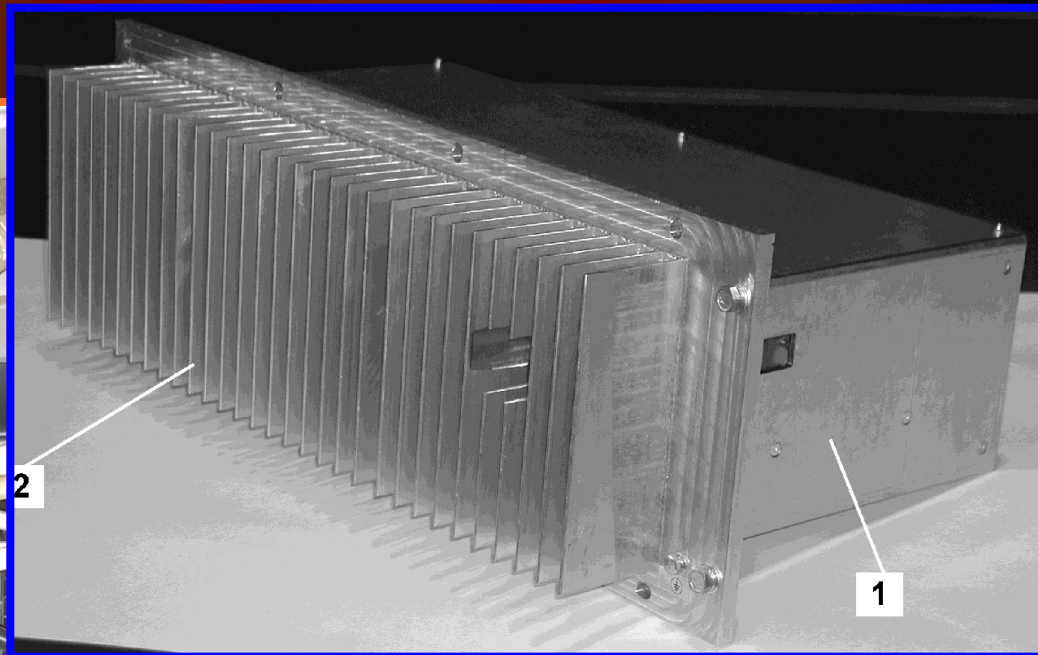
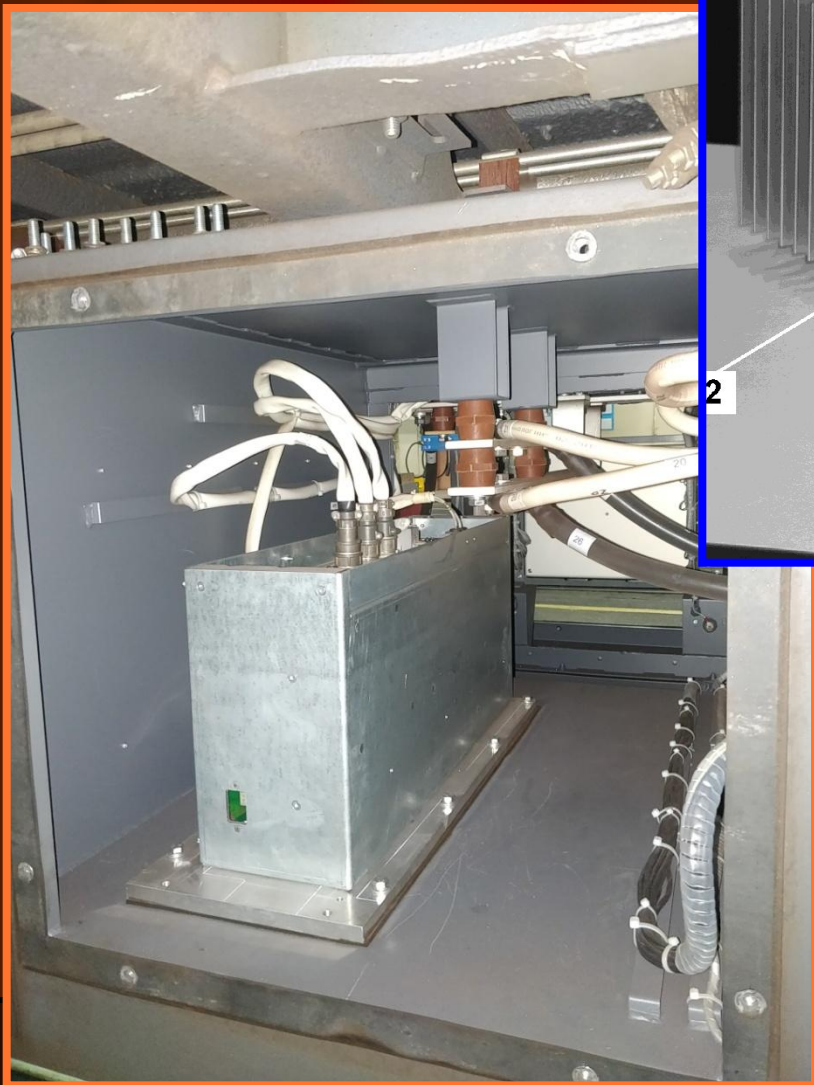

Отсек №7. Быстродействующего. Выключателя.

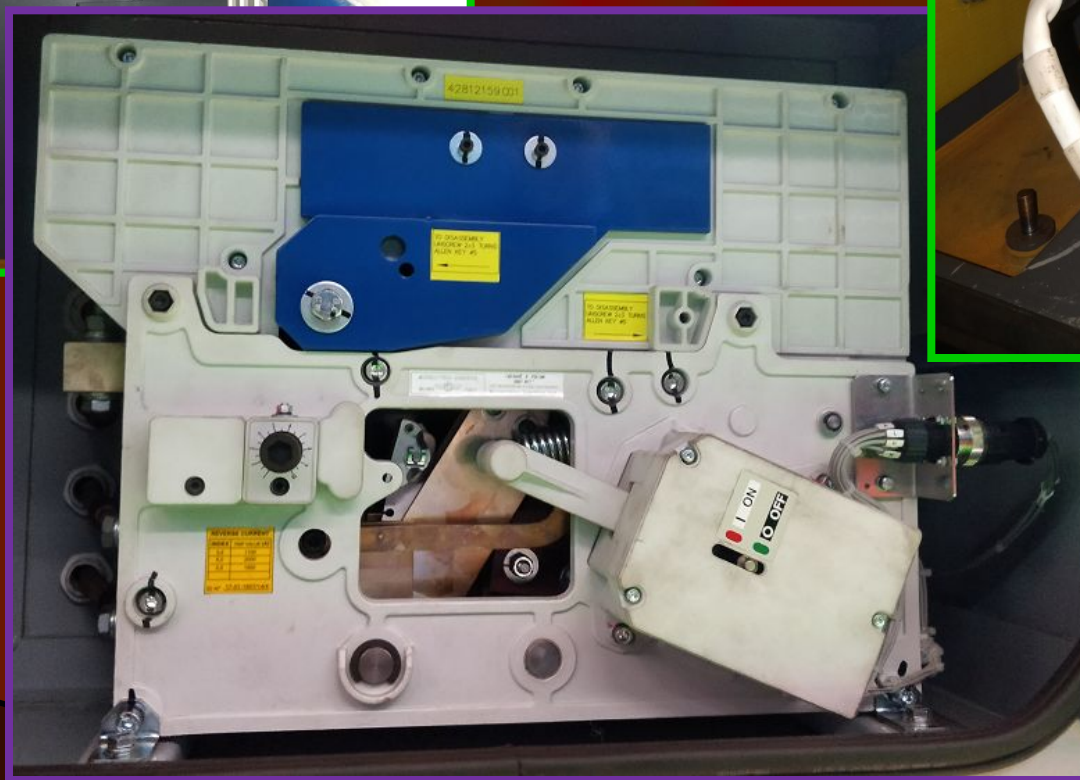
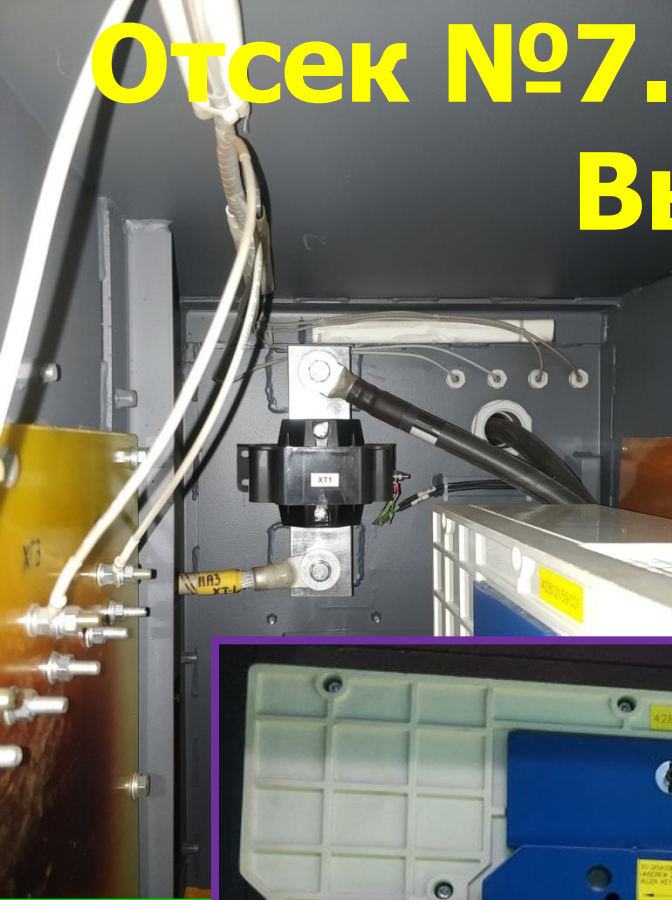

Разрядный резистор.



Отсек №8. Центральный.



Реактор сетевого фильтра.

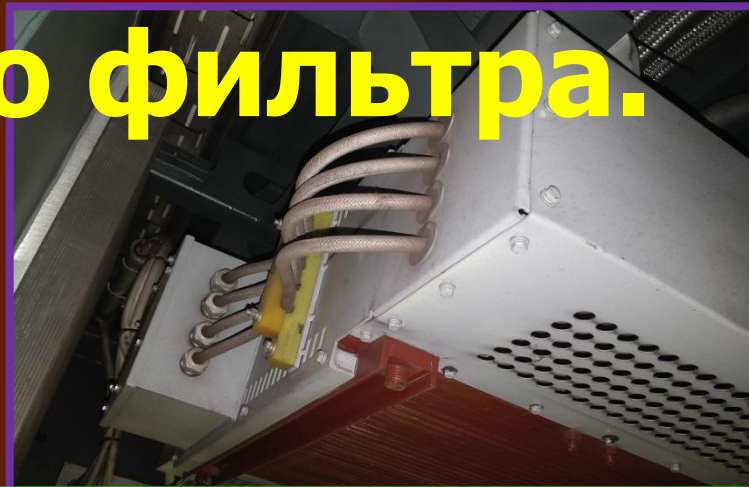

Тормозной резистор.

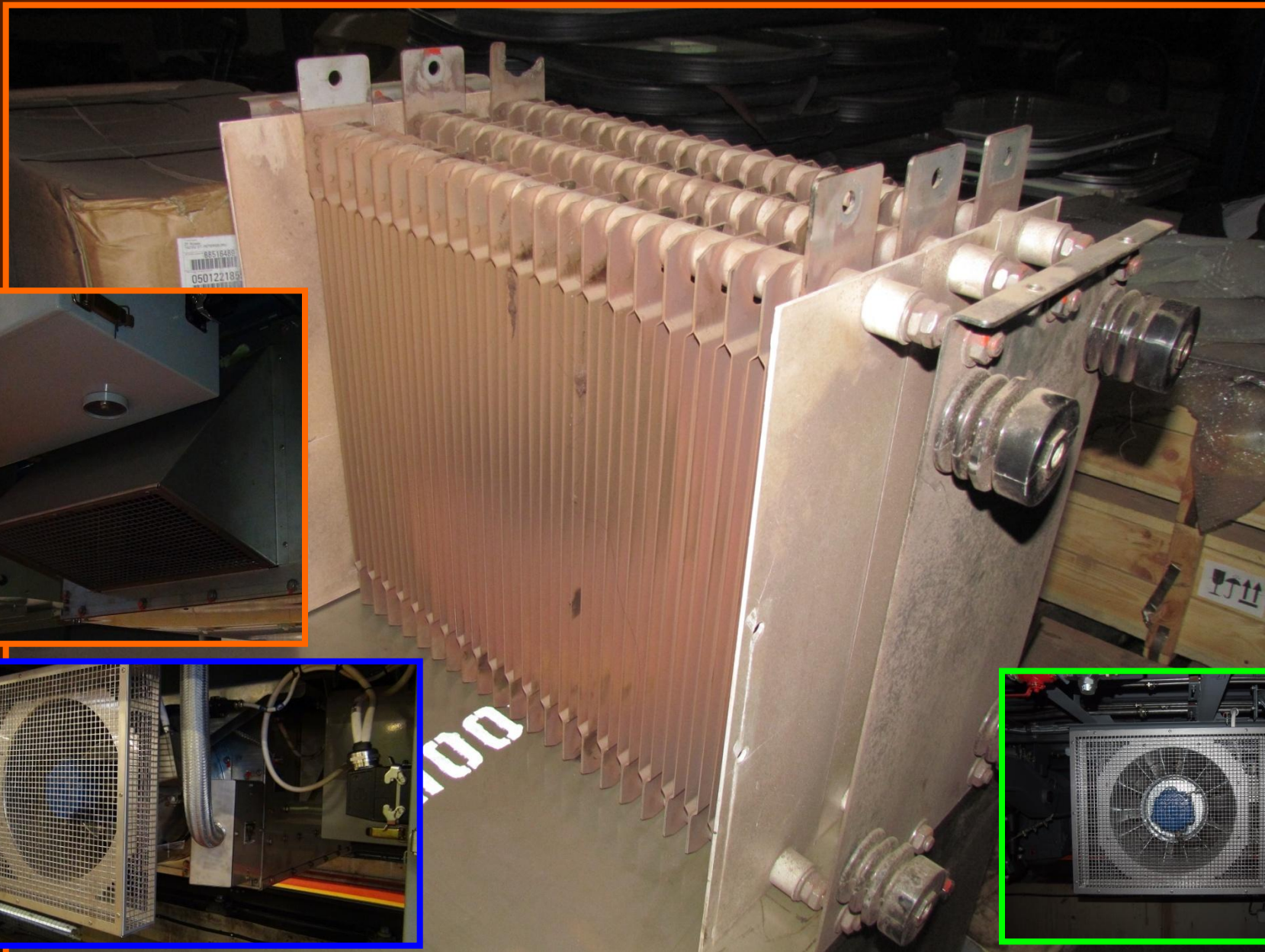

Тяговый двигатель ТАДВМ-280, датчик частоты вращения ДЧВ.

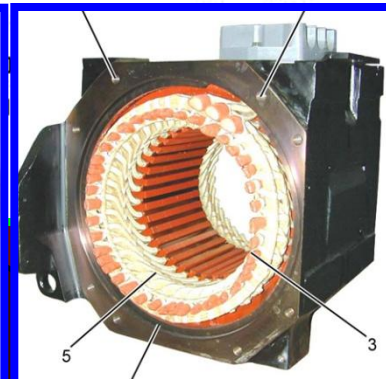
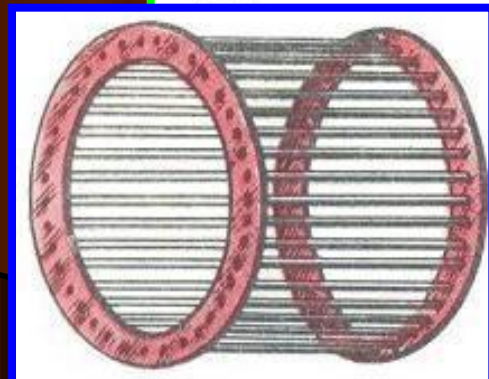
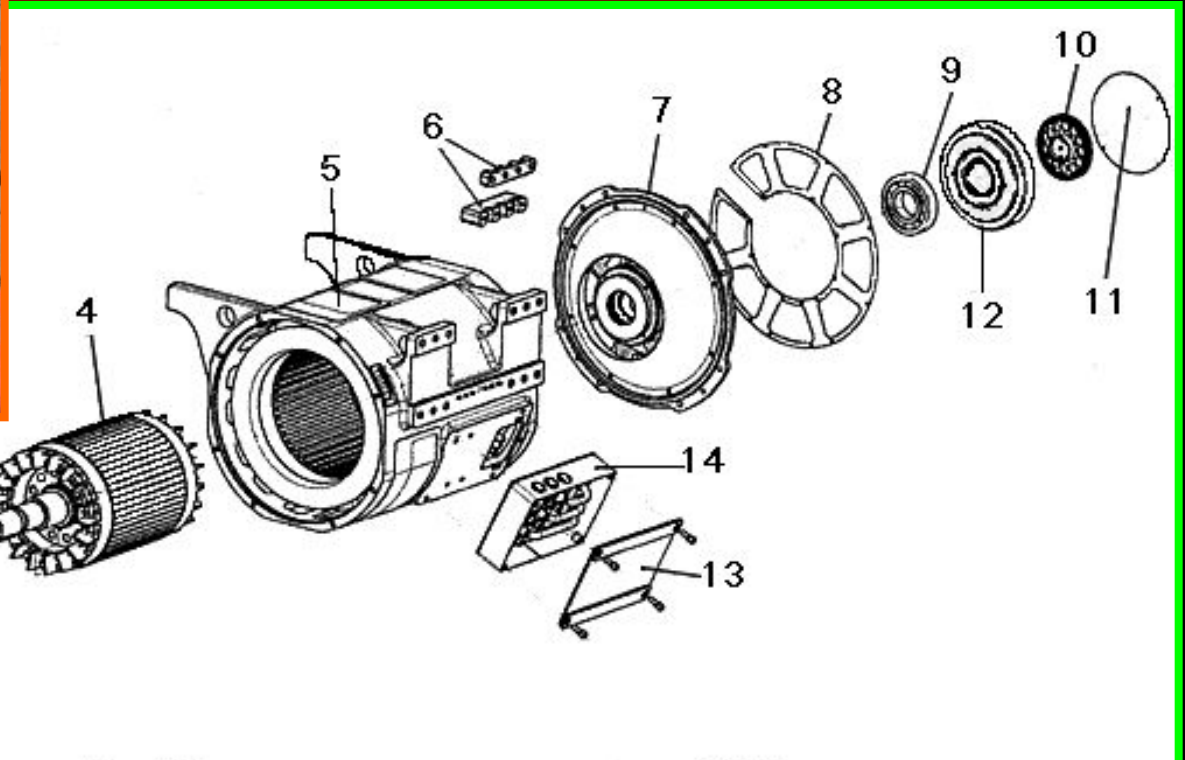

Токоприемник рельсовый ТРА-02.

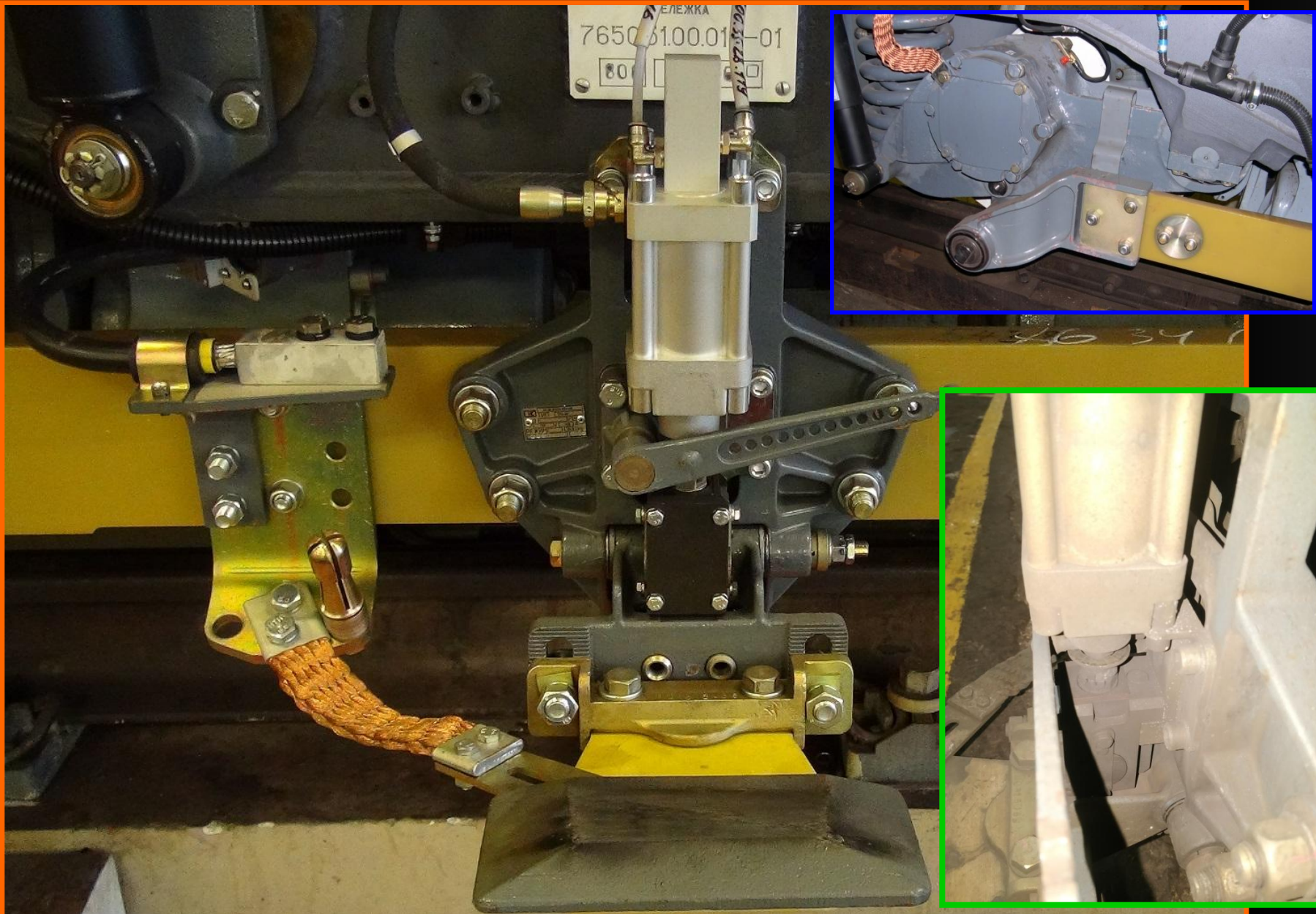

Батарея аккумуляторная А510/55А «Sonnenschein».

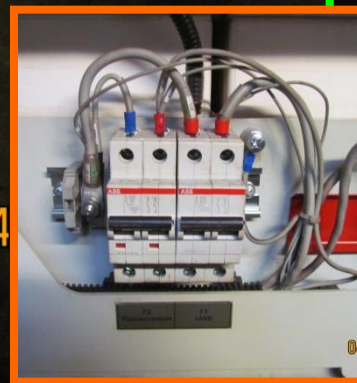
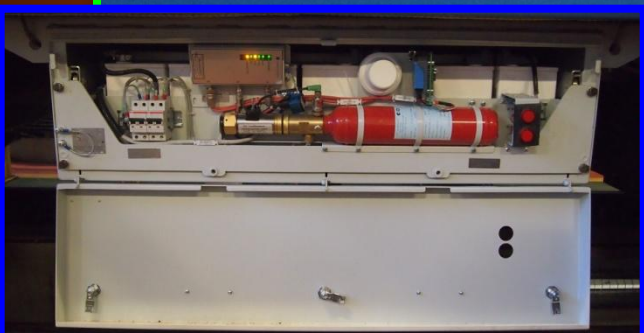
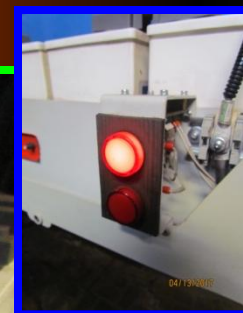

04

Батарея аккумуляторная А510/55А «Sonnenchein». внешняя крышка.

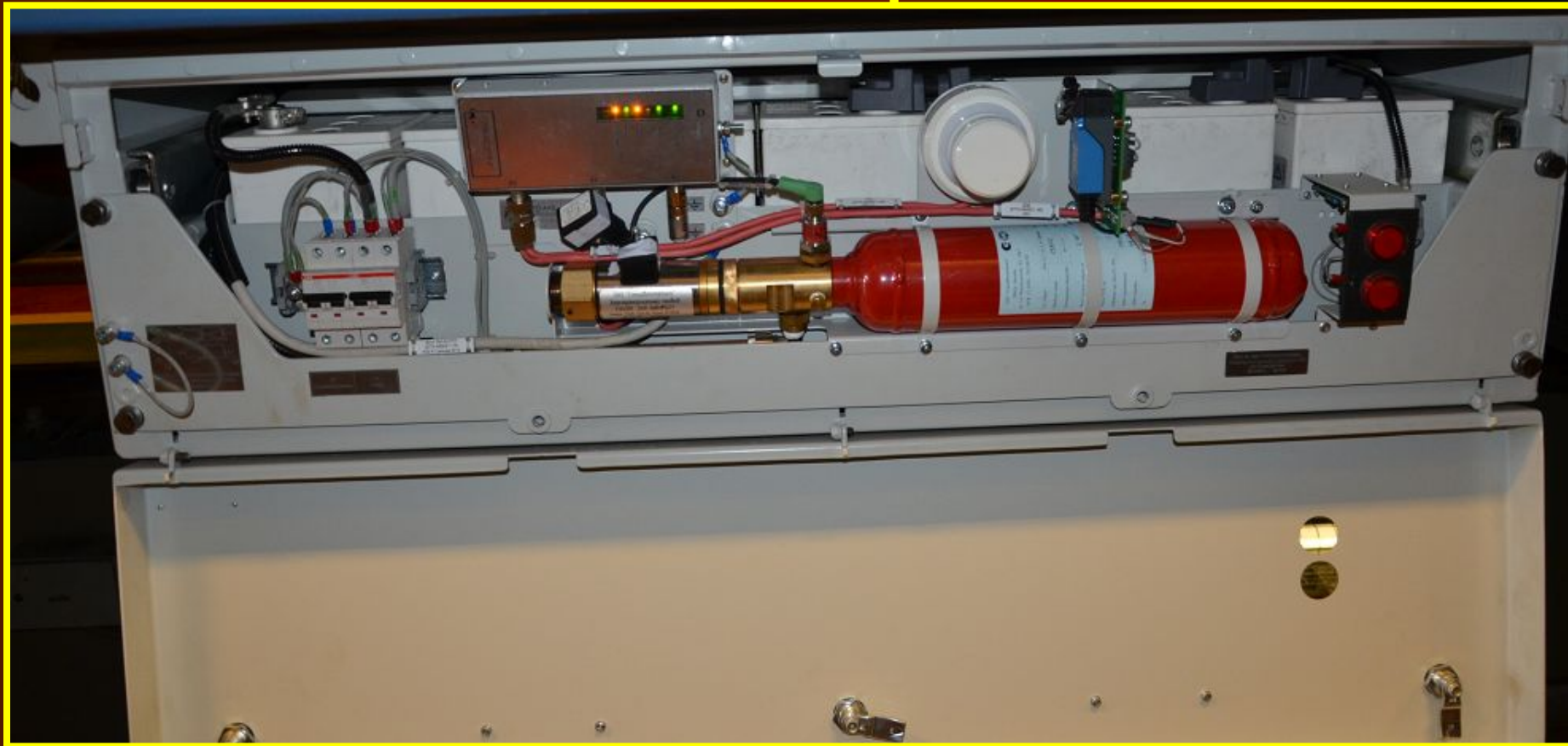

Блоки соединительные: БС-ЯН, БСДТ, БВС.

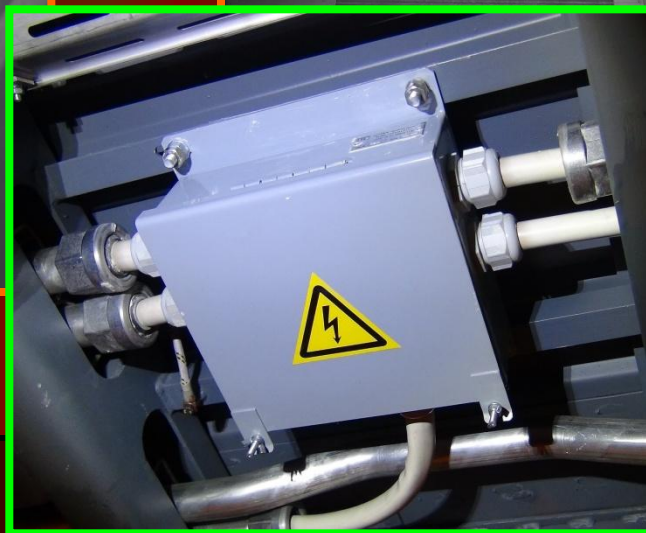
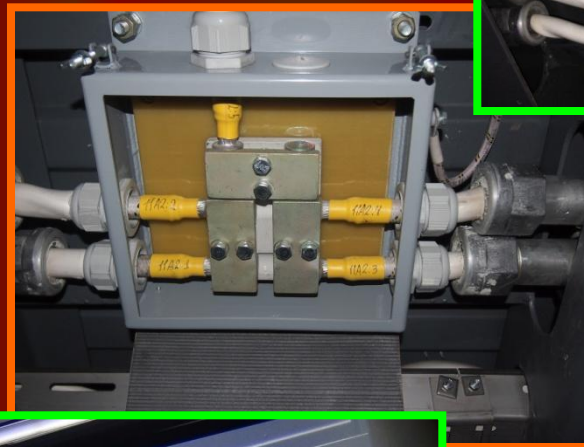

BC 120, BC 50.



Блок распределительного устройства БРУ.



БДН и Модуль радио помех.



Блок разделительных диодов. БРД.

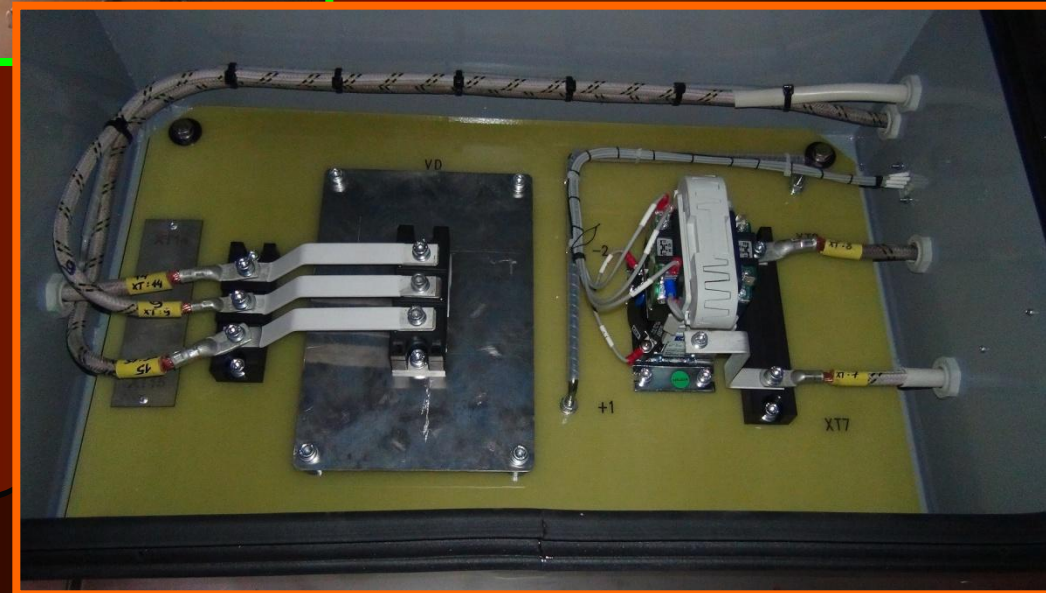

ПСН 765.



Универсальный токоотвод.

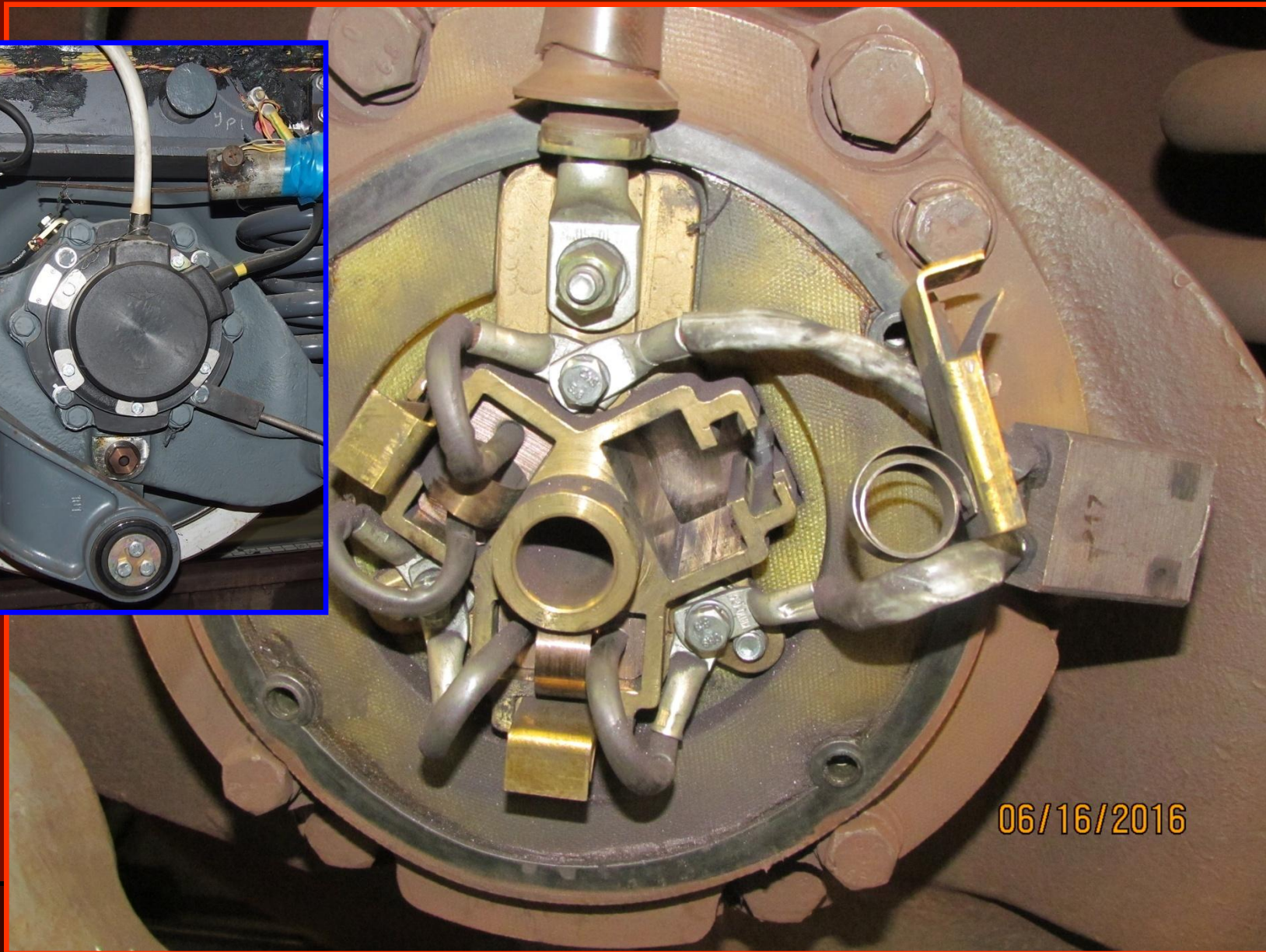
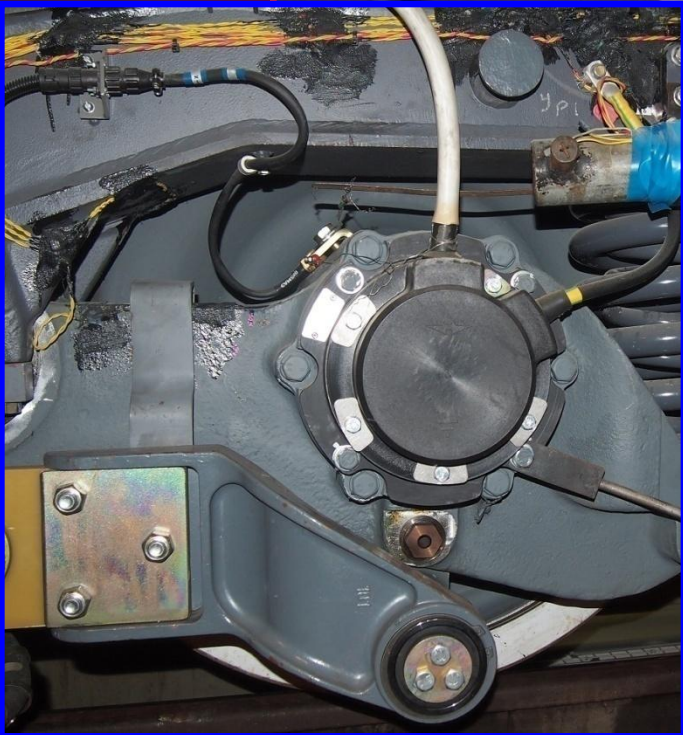

06/16/2016

БККЗ и ДКЗ.

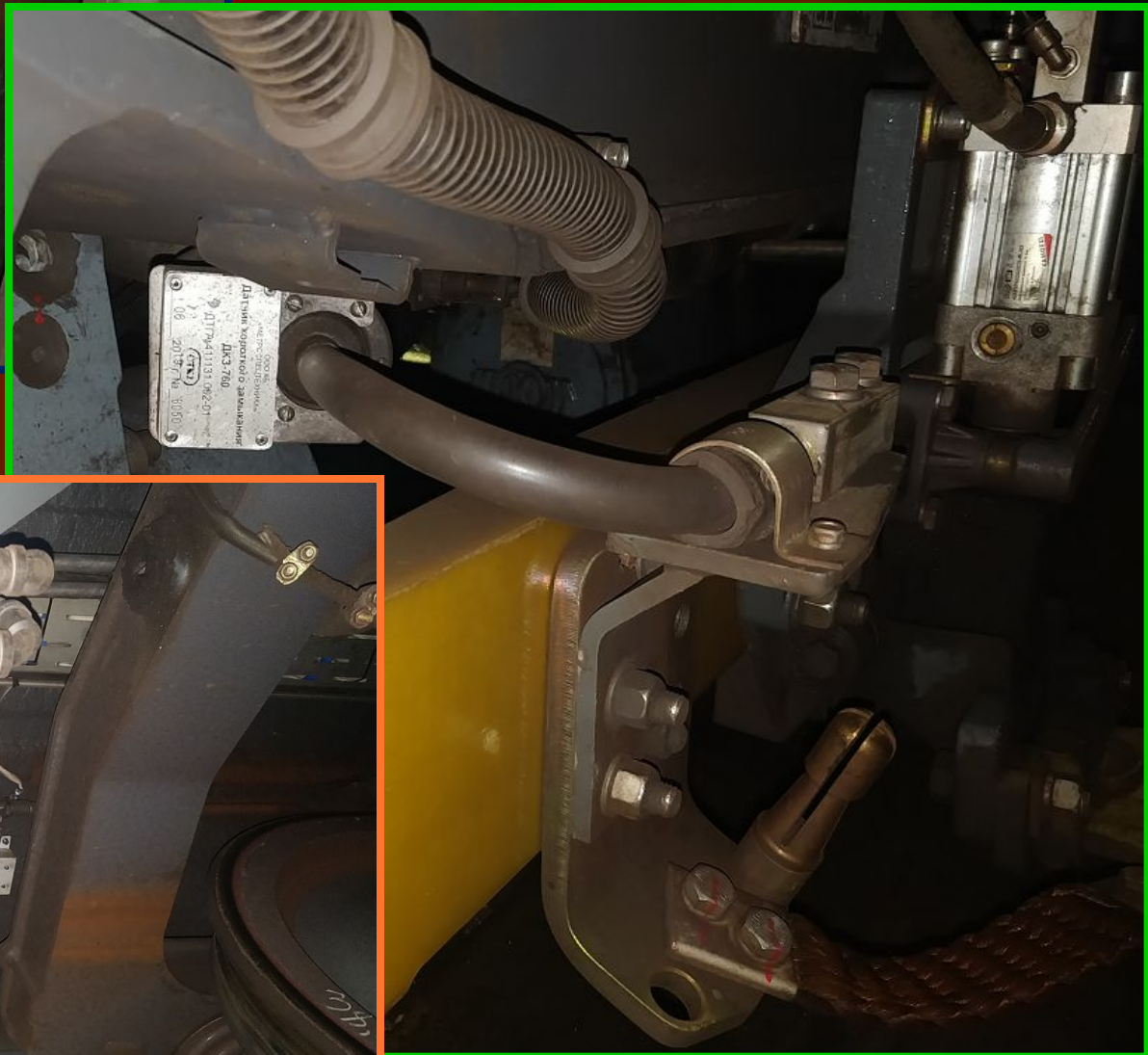

Детали, изготовленные
в соответствии с требованиями
СТАЗ
ДКЗ-760
1177410181.002.01
08 20177 10 80000

Переключатель НВМ-741.

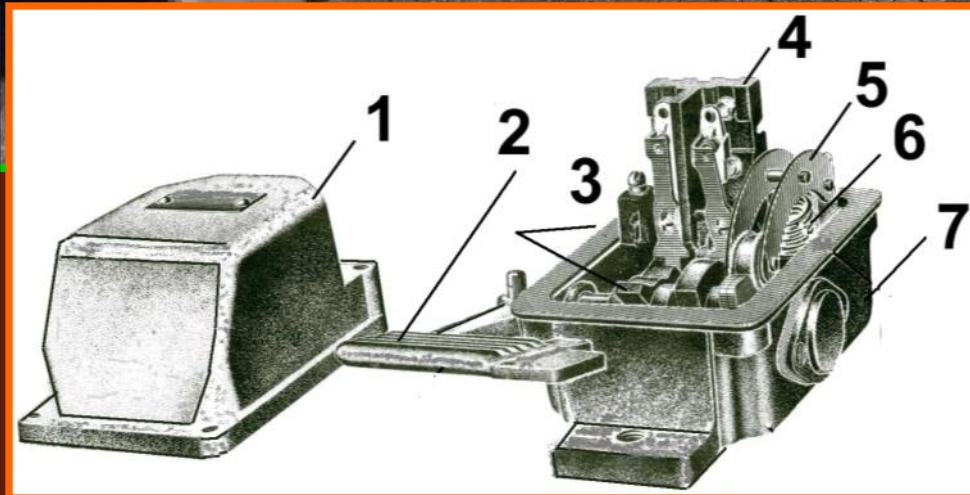

ЗУП и БЭС.

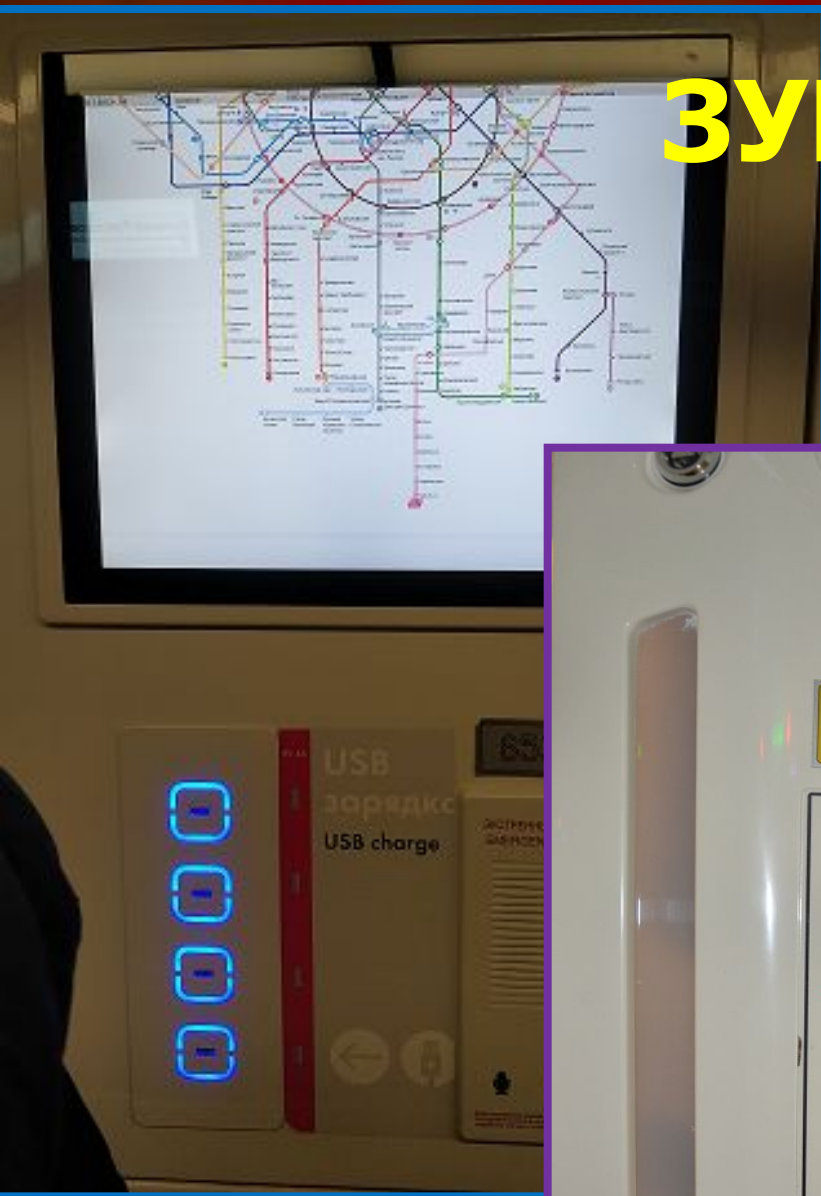

Блок надверного табло и рекламы.

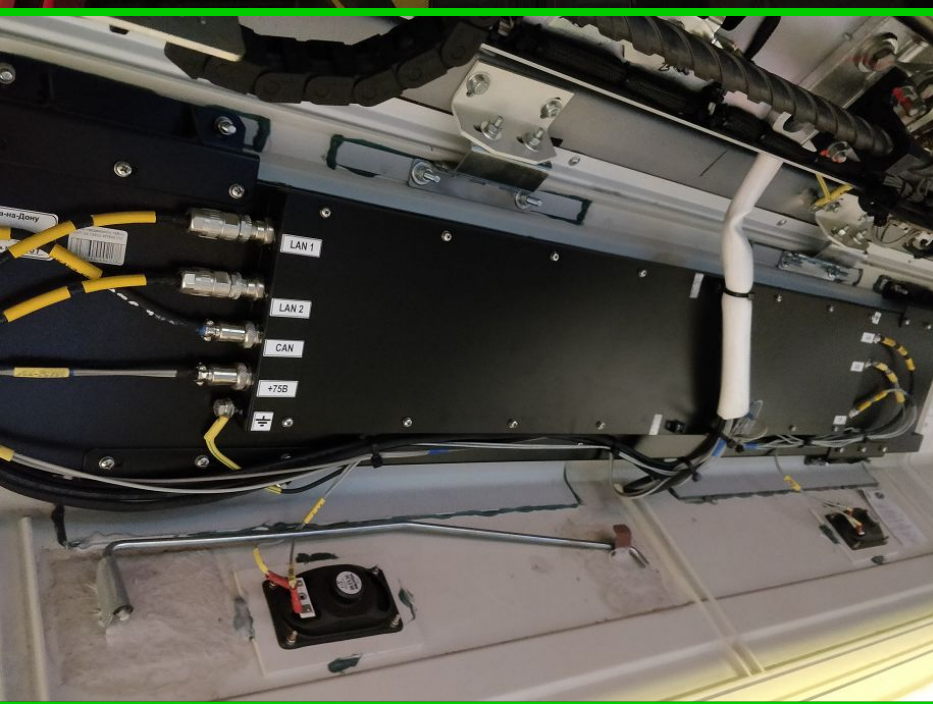
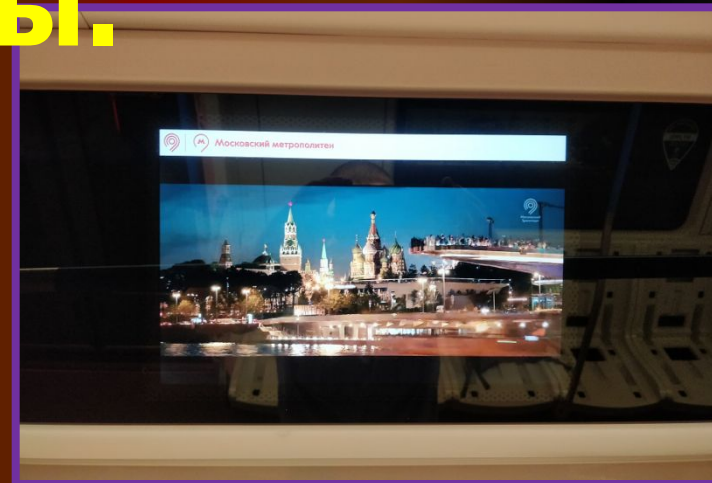
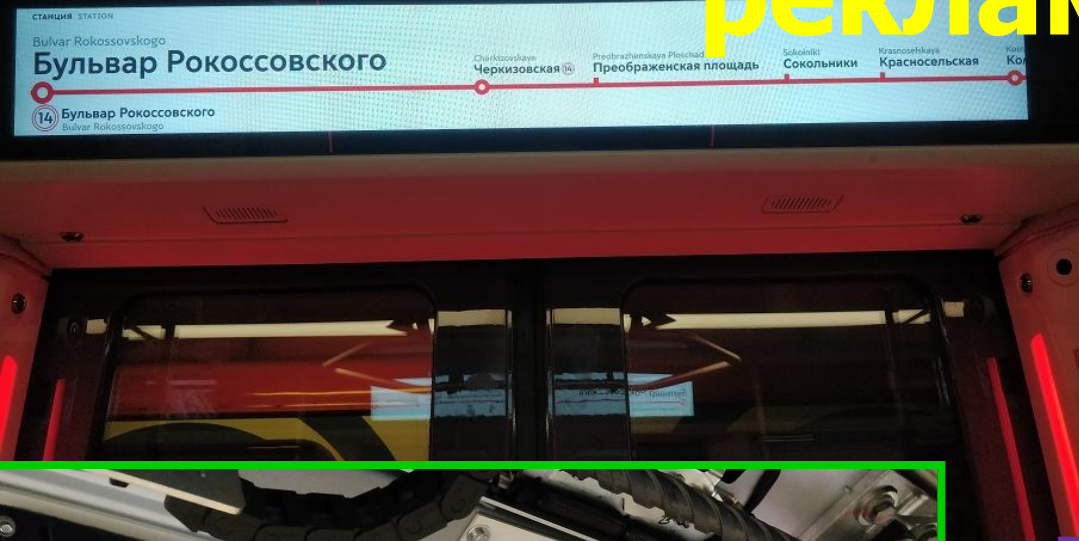

Блок управления нагревом стекол (БУНС).

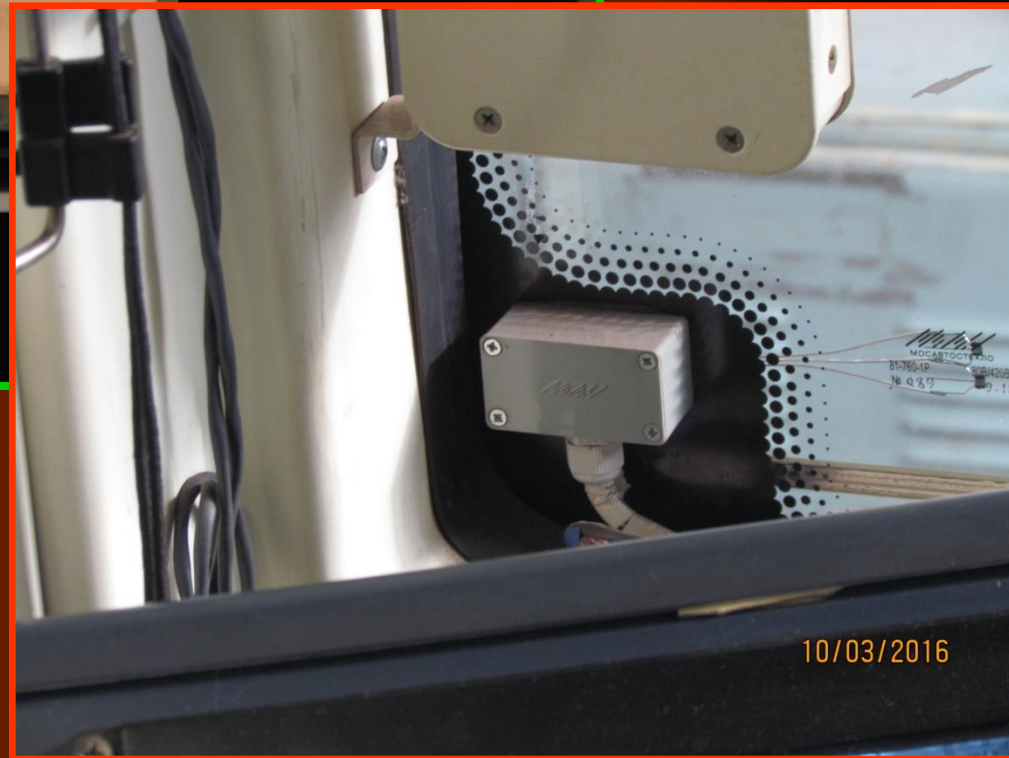

Блок управления дверьми (Буд)

