

Mashum e'pici

Эрстед тәжірибесі.

Ампер тәжірибесі

Магнит өрісі.

Магнит өрісінің сипаттамасы

Магнит өрісін қолдану



**Ганс
Христиан
Эрстед**

Эрстед тэжірибесі (1820г)

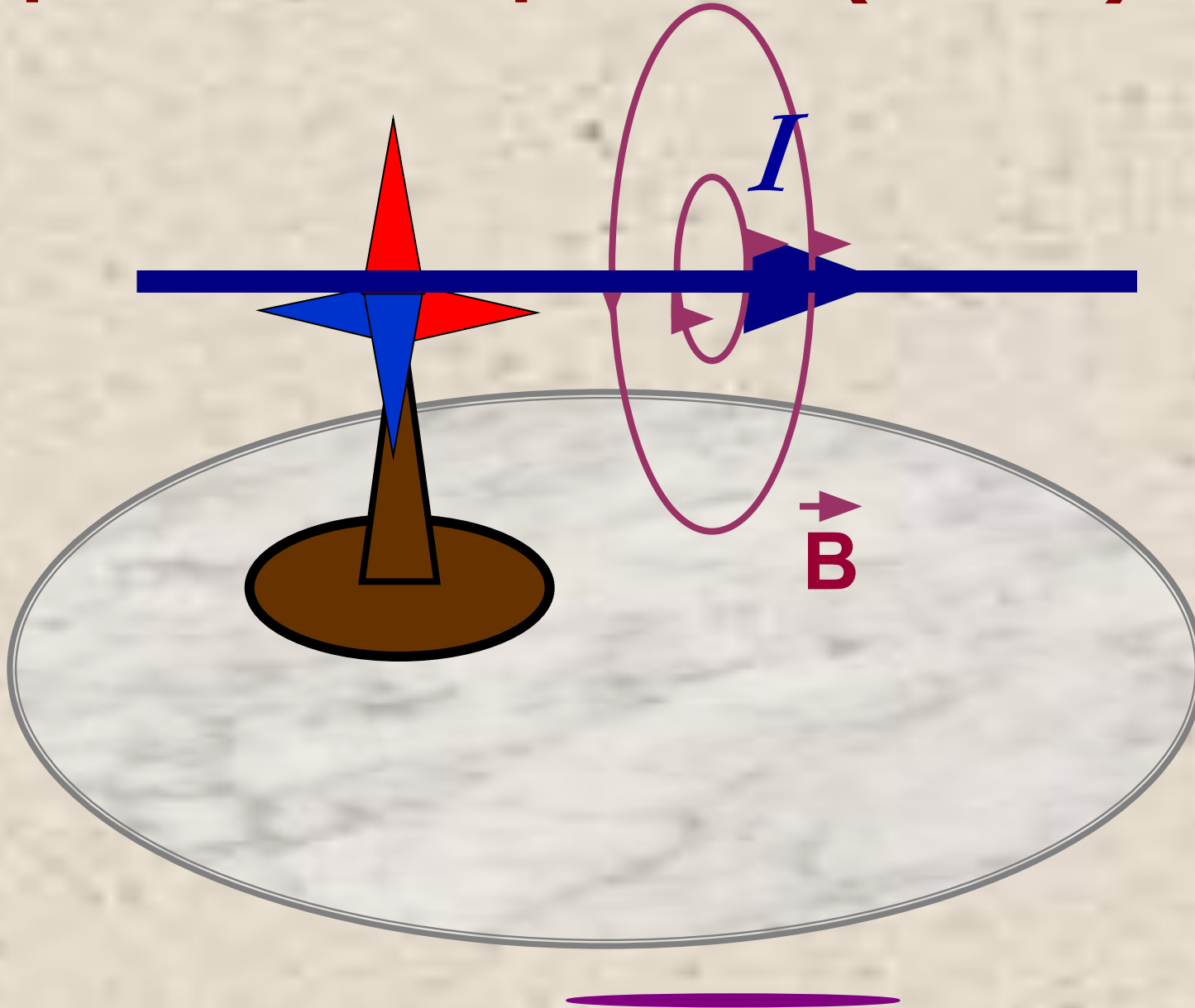



**Электр және
магнит өрісі
арасындағы
байланысты
алғаш
пайымдаған
ғалым**

**Анри Ампер
Француз физигі**

Ампер тәжірибесі

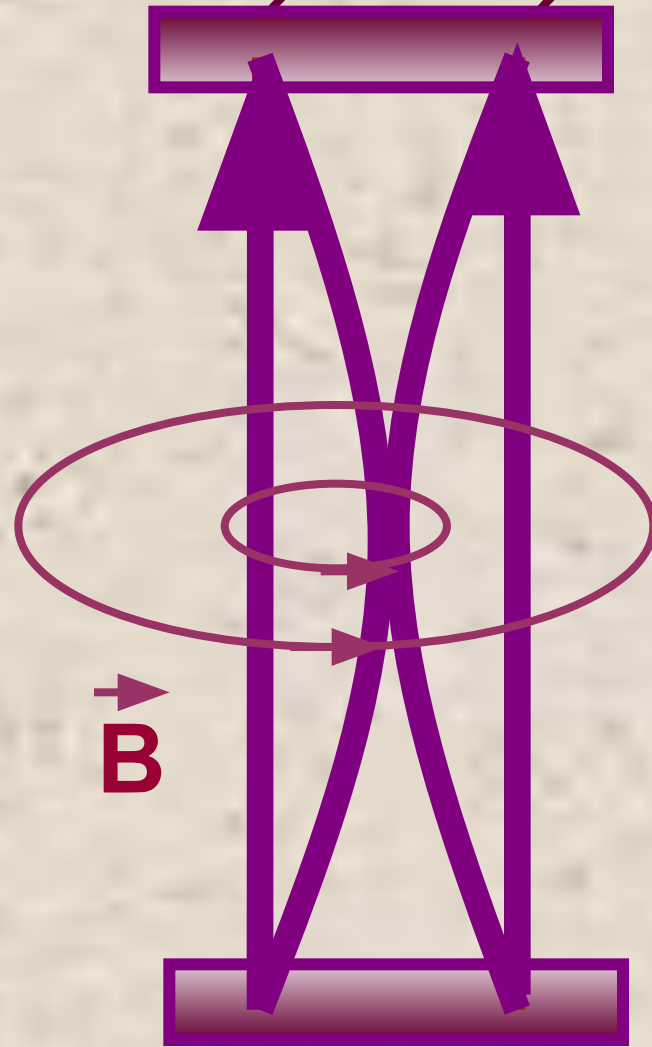
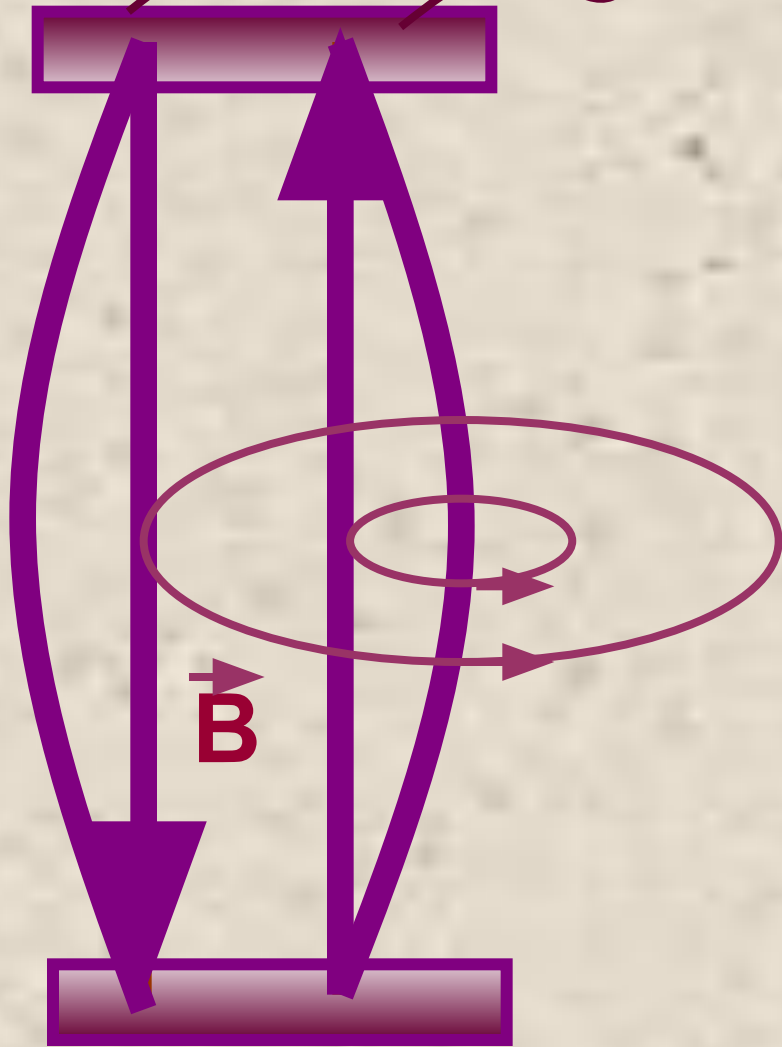

Тоғы бар өткізгіш айналасында магнит өрісі болады



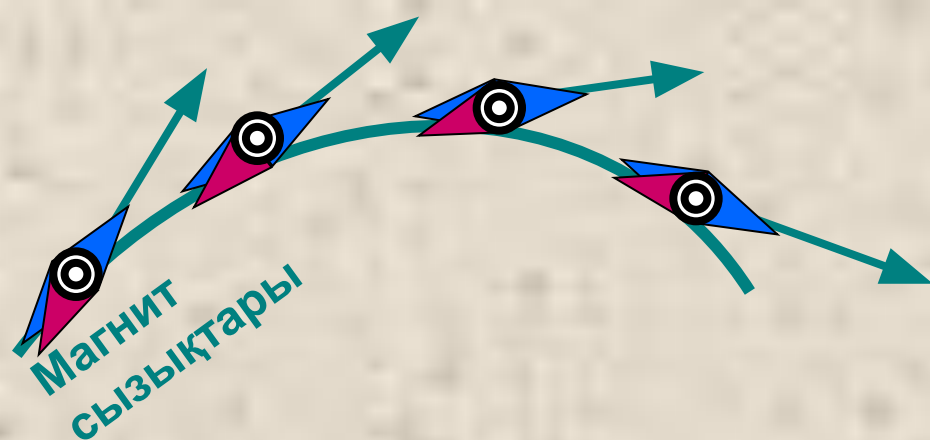

Магнит өрісі сызықтарының қасметтері:

- Әрқашан тұйықталған;
- үзіліссіз;
- қиылыспайды;
- Өріс көп жерде қалыңырақ.



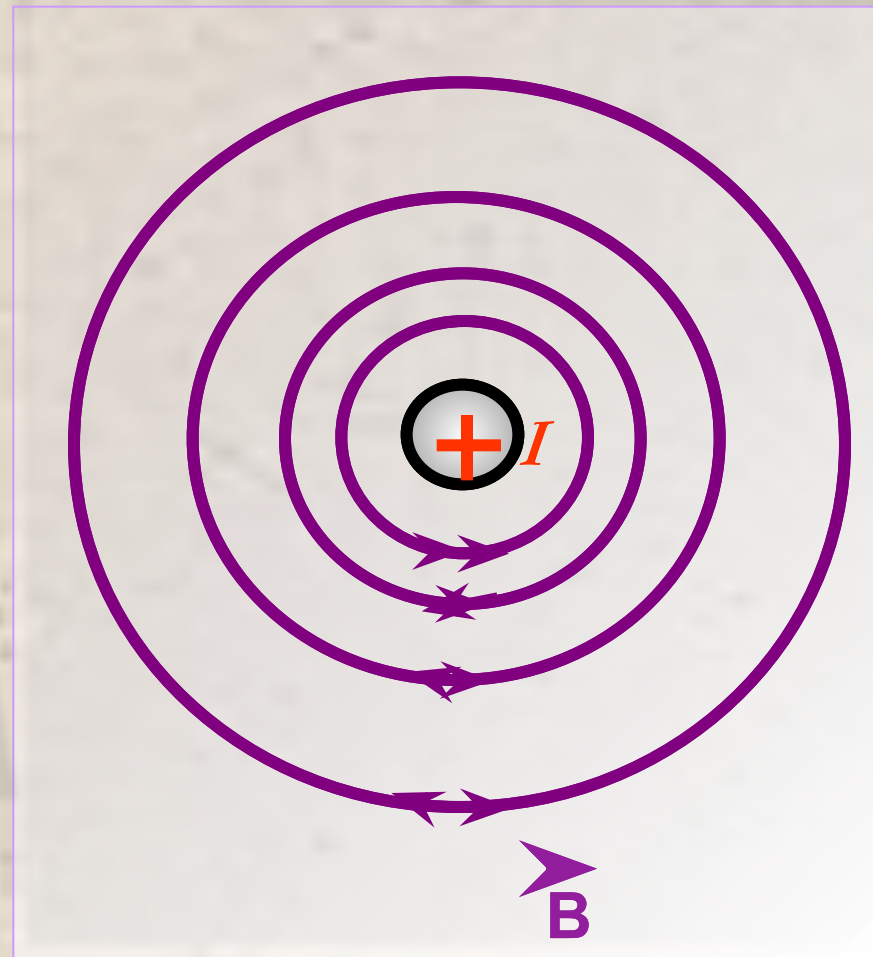
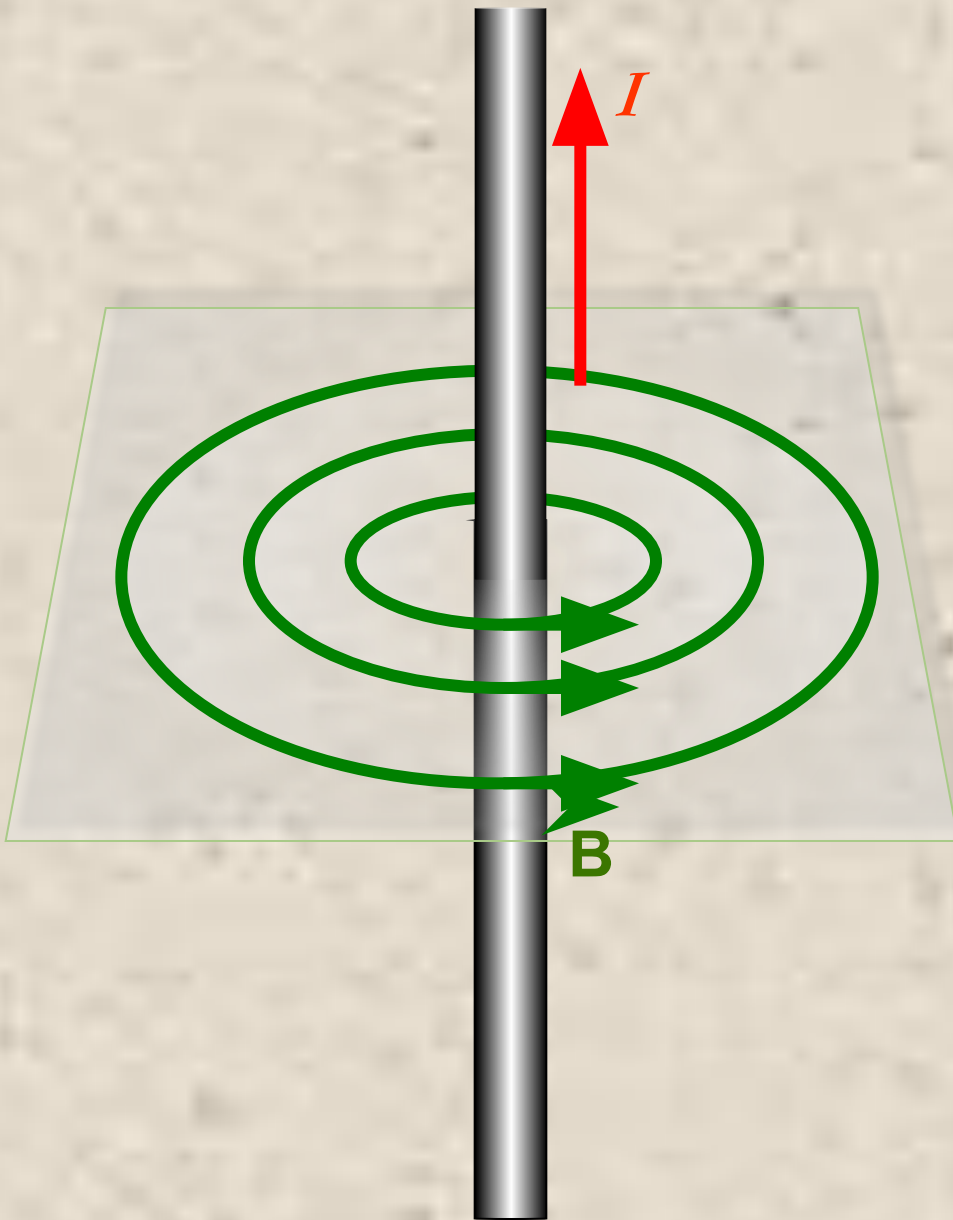

- $+$ - ток бізден әрі
- \bullet - ток бізге қарай

Тогы бар өткізгіш.



Тогы бар атушка

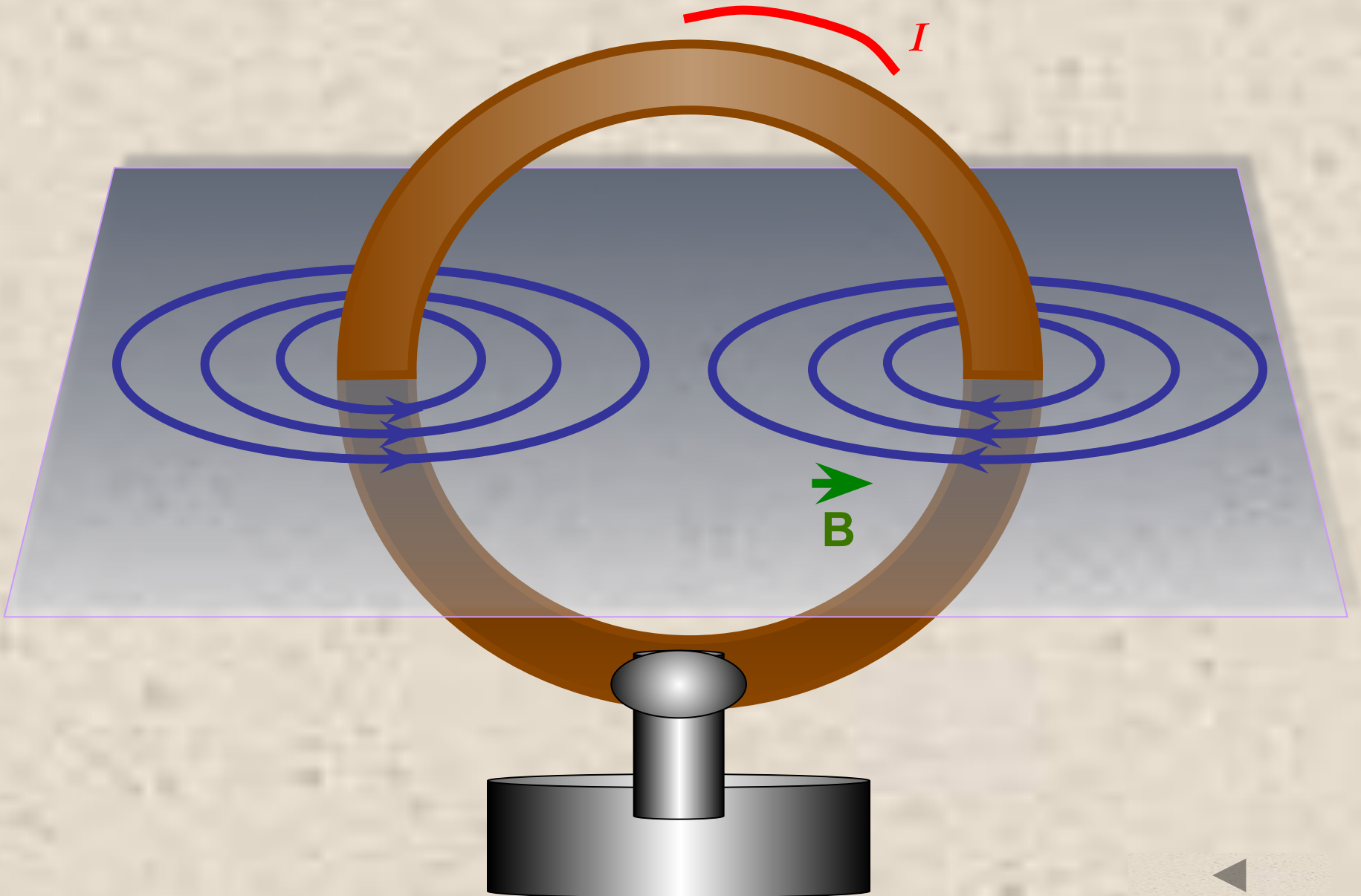

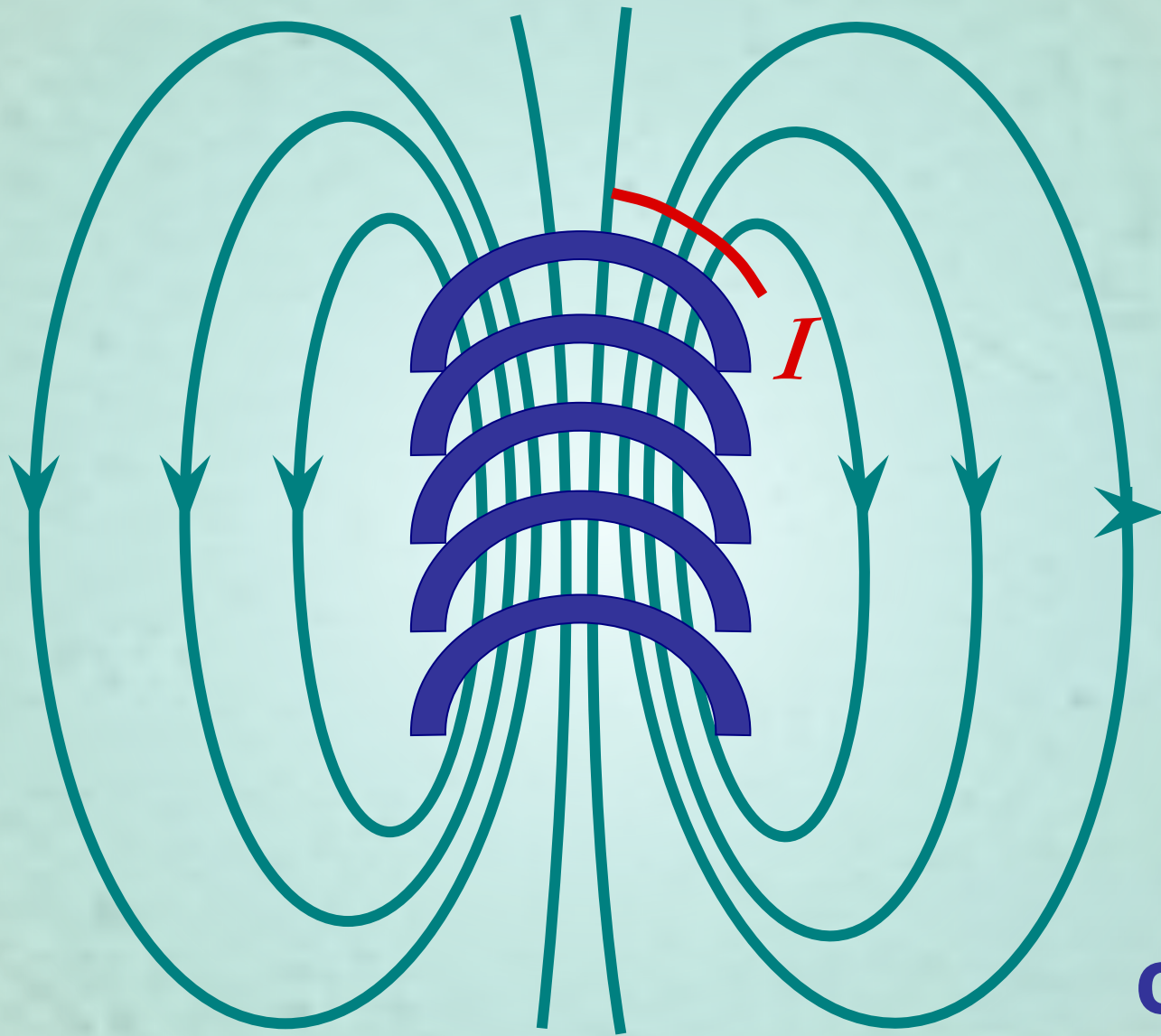

соленоид



Тұрақты магнит

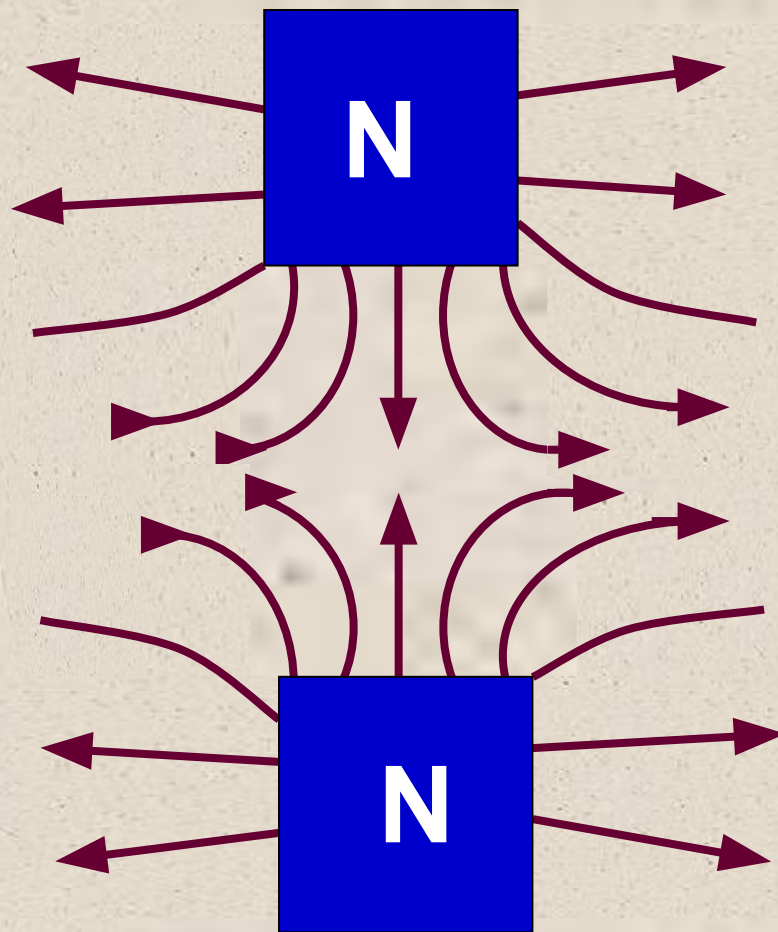
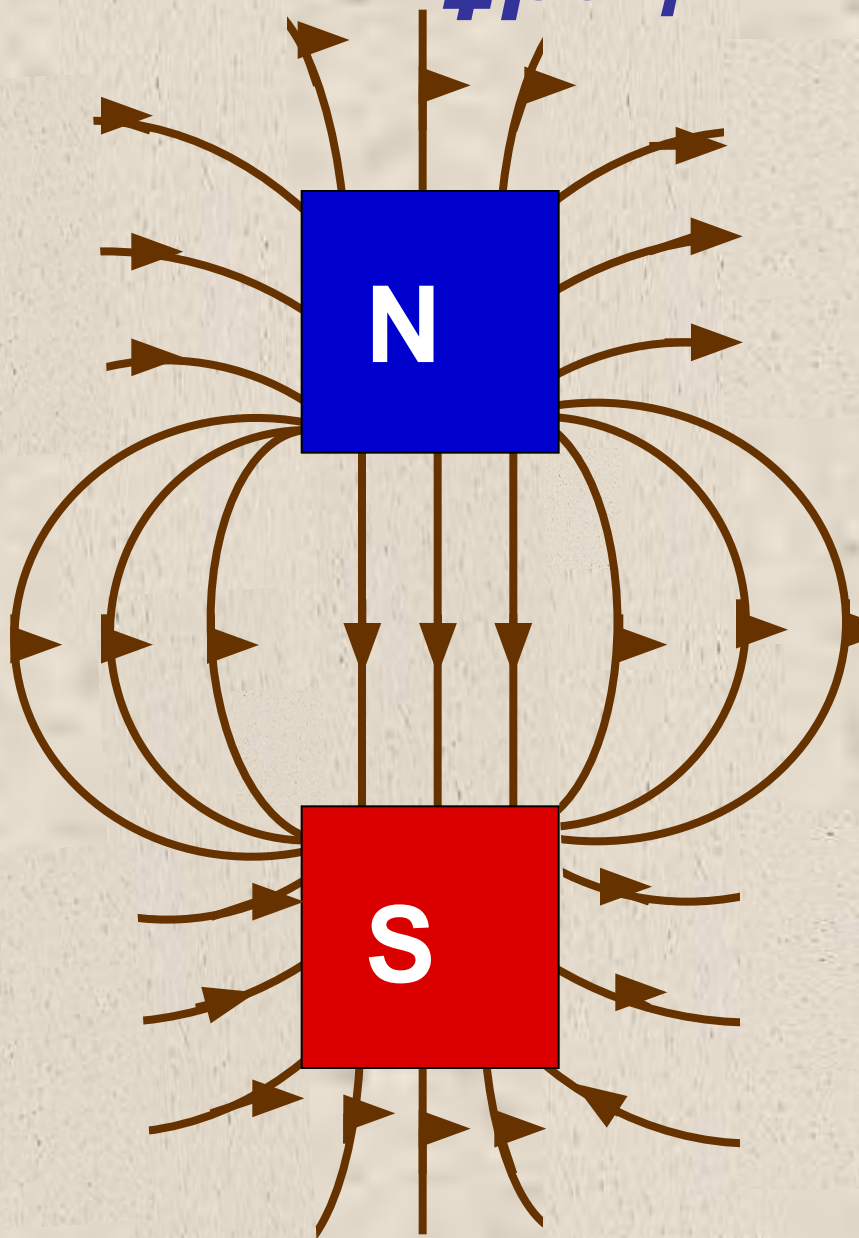

Магнит өрісін сипаттайтын шамалар:

а) Магнит индукция
векторы

б) Магнит ағыны.



B – магнит индукция векторы.

1. магнит индукция векторының модулі :

$$B = \frac{F}{I \ell}$$

*ℓ – өткізгіш
ұзындығы;*

I – ток күші;

2.Өлшем бірлігі: Тесла (Тл).

$$1 \text{ Тл} = 1 \frac{\text{Н}}{\text{А} \cdot \text{м}}$$



Бұрғы ережесі:

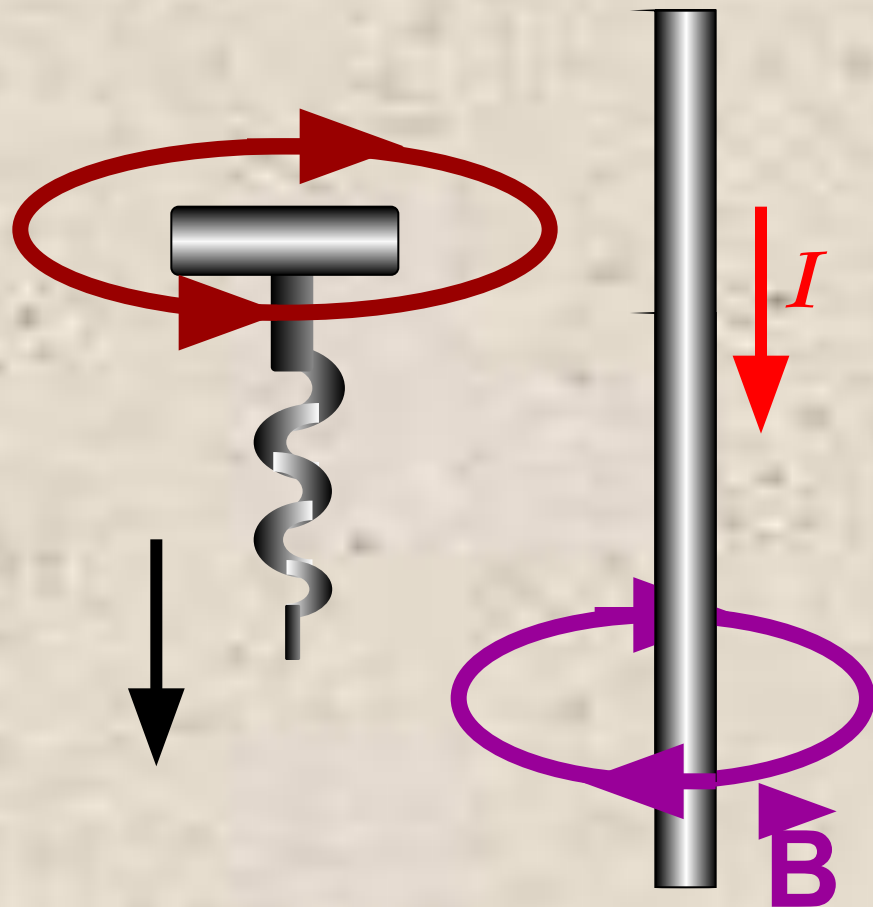

3. Оң қол ережесі:

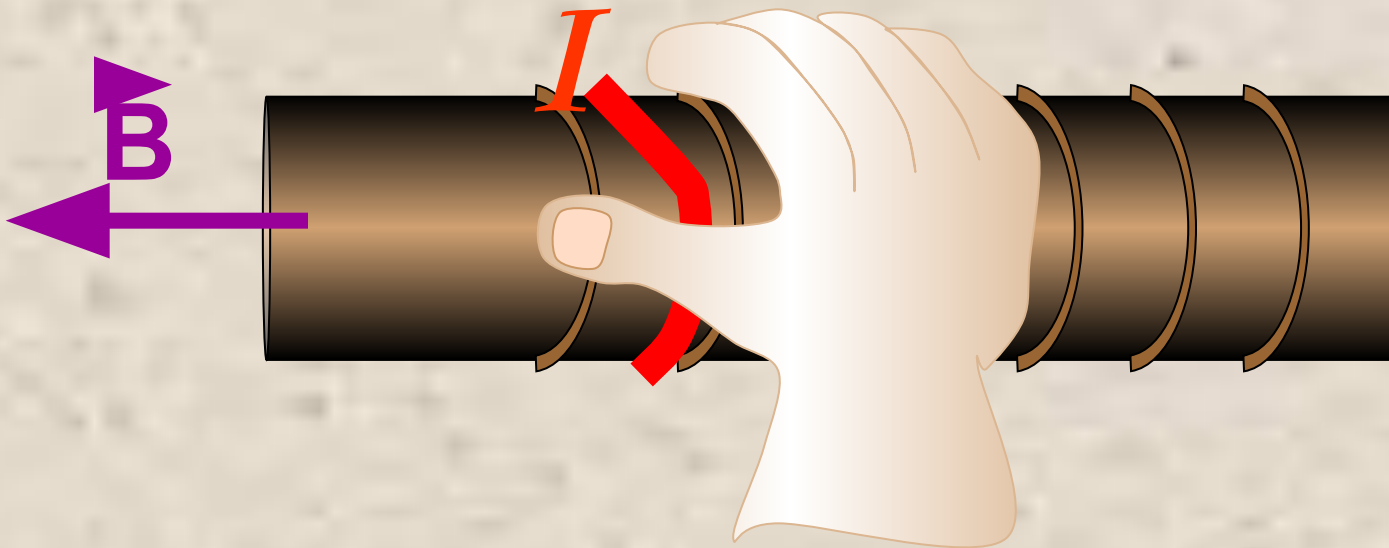

Φ – магнит ағыны.

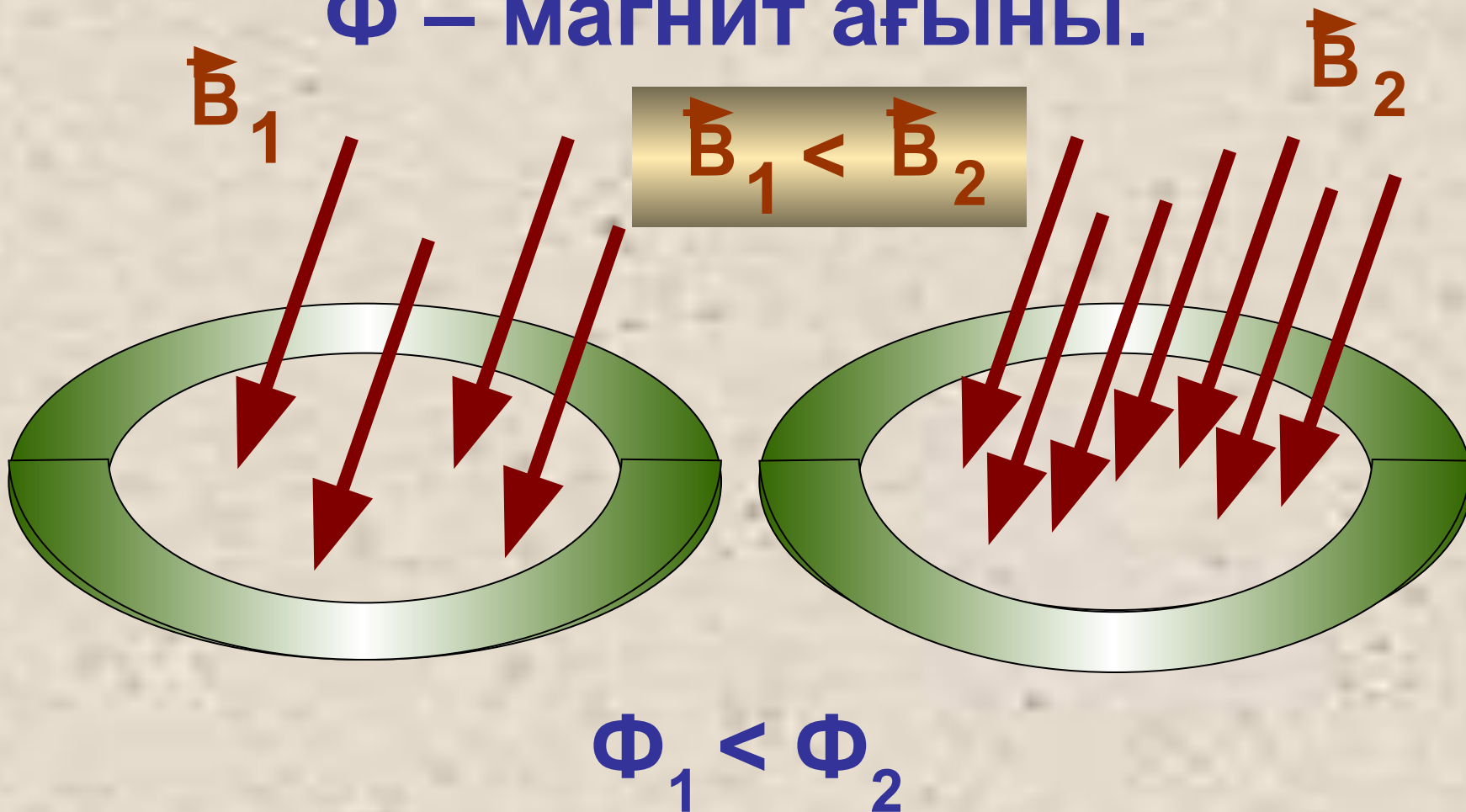

$$\Phi = BS \cos \alpha$$

$$\vec{B}_1 = \vec{B}_2$$

$$S_1 < S_2$$

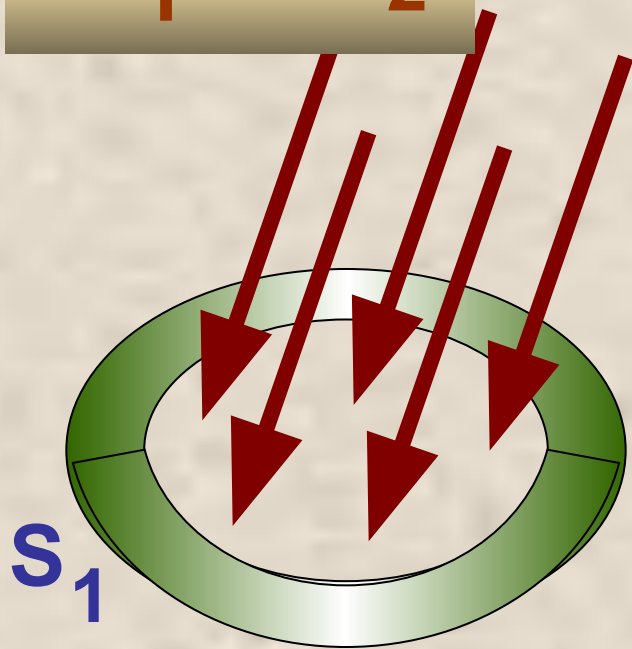
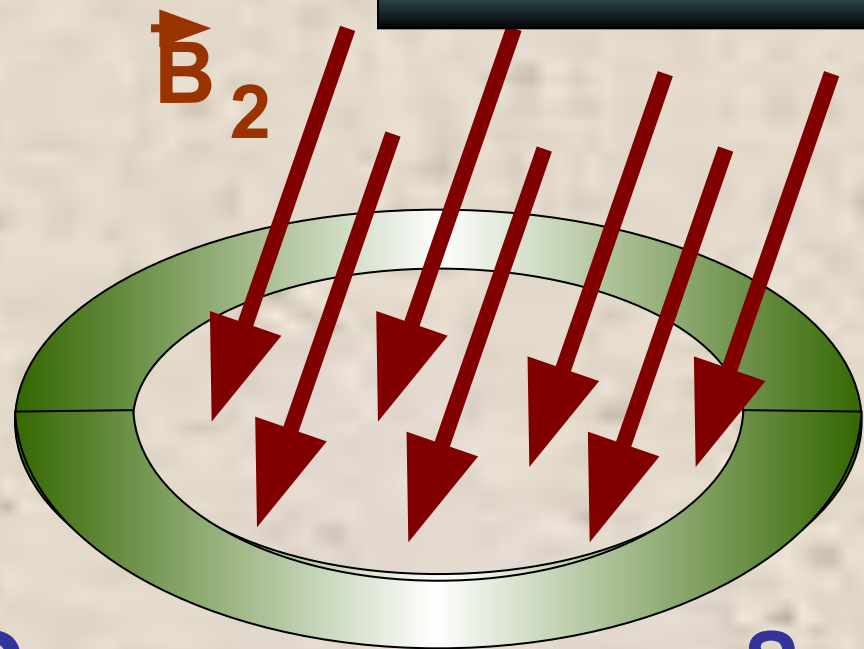
 \vec{B}_1  \vec{B}_2

$$\Phi_1 < \Phi_2$$

 S_2

$$\vec{B}_1 = \vec{B}_2$$

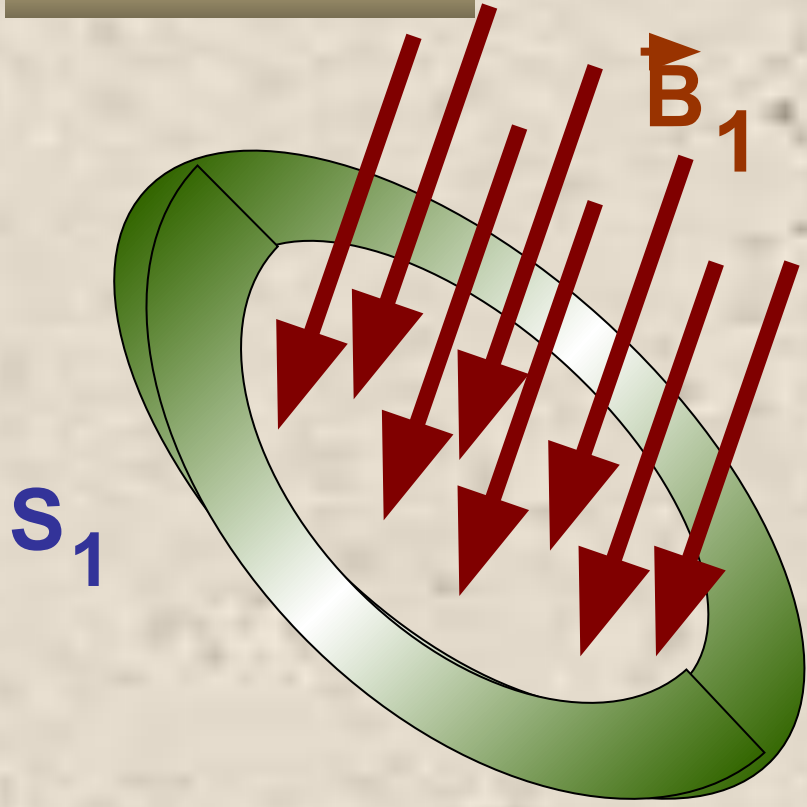

$$S_1 = S_2$$

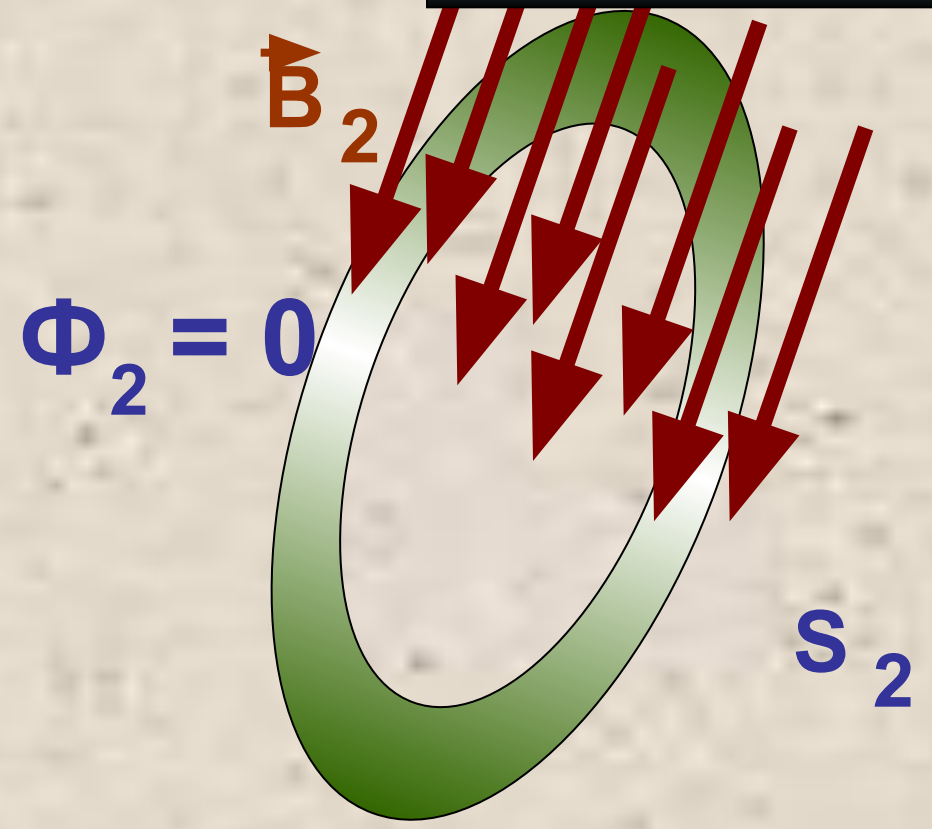

Ампер болжамы:

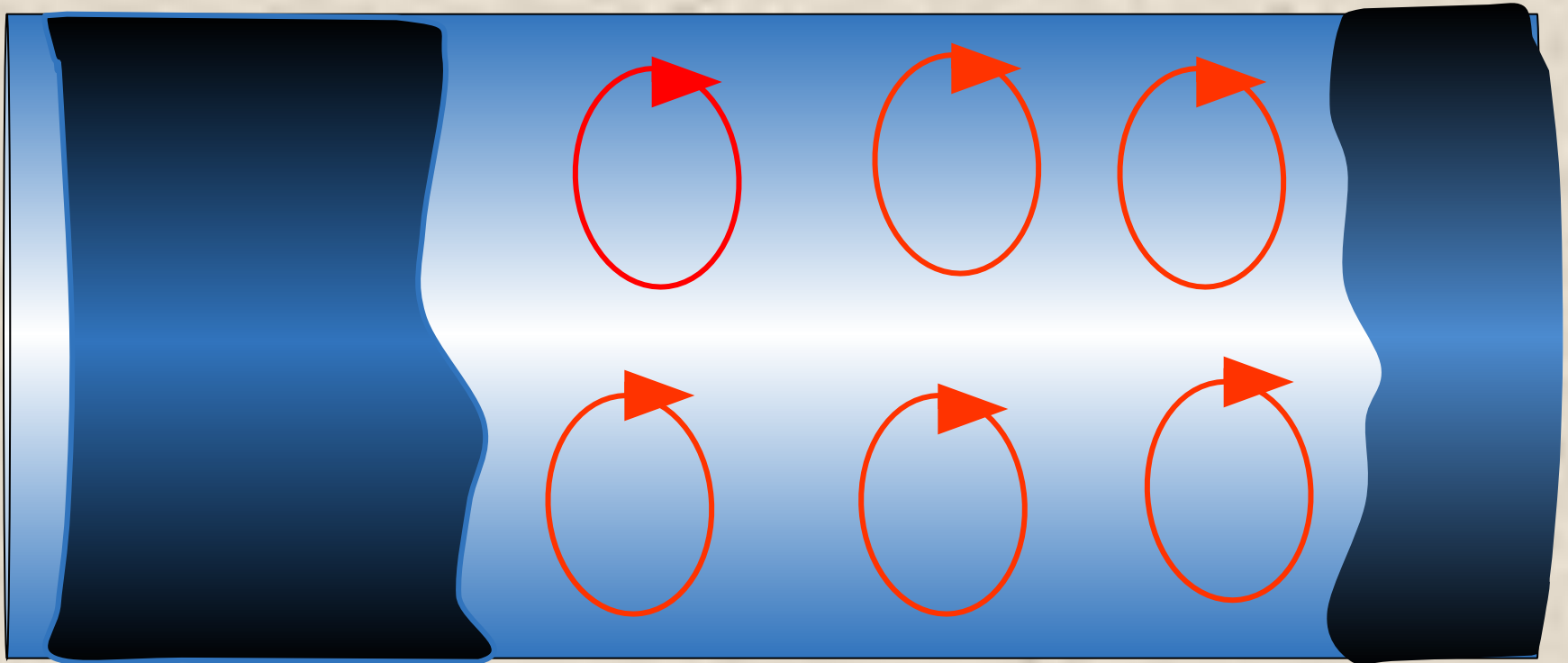

Қазіргі заман

физикасы:

