

ISISCOM

Telecommunication Company





Administrația

- Director General : Șpac Cristina
- Director Tehnic : Gobjila Nicoleta
- Director Software : Todirașco Mihail
- Director Economic: Iordanov Eugen
- Director Marketing : Guțu Natalia
- Director Resurse Umane: Capcanov Oleg



Realizarea rețelei de comunicații în baza topologiei “Plasă”

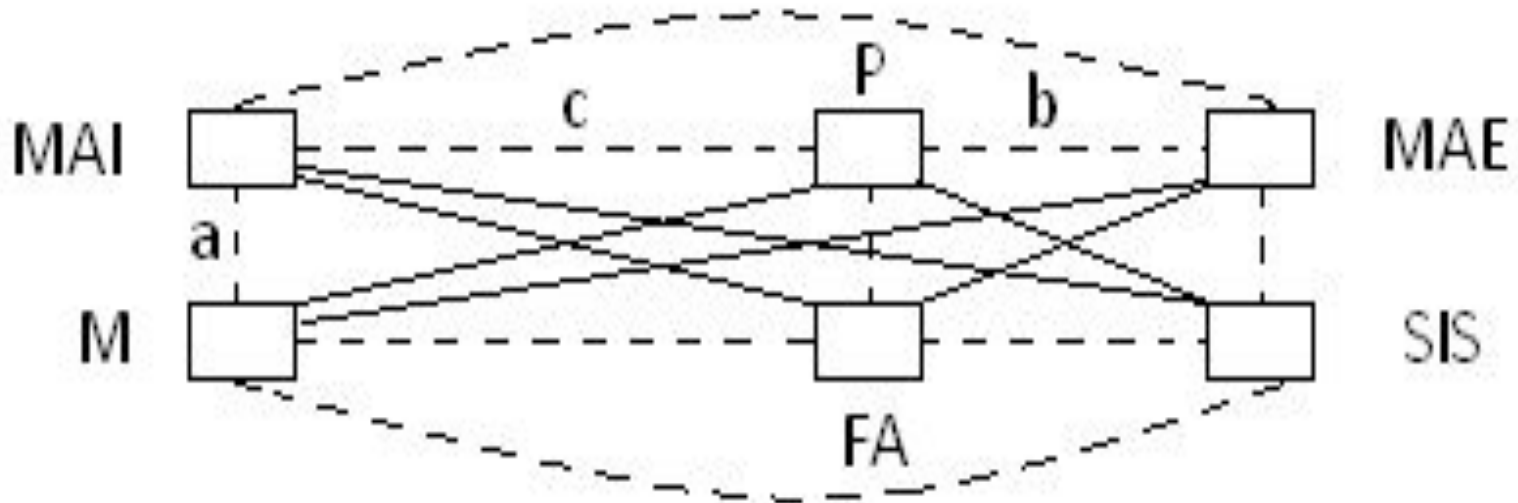



Punctele strategice din Republica Moldova

P- Președenția R. M.

MAI – Ministerul Afacerilor Interne al R.M.

MAE – Ministerul Afacerilor Externe al R.M.

M – Mitropolia R.M.

FA – Forțele Armate al R.M.

SIS – Serviciul de Informații și Securitate al R.M.



Distanțele dintre punctele strategice. Calculul indicatorilor

$$a = 1/5c = 300 \text{ m}$$

$$b = 2/3c = 1000 \text{ m}$$

$$c = 1500 \text{ m}$$

Indicatori : n, N, PC

$$\square n = 6 \text{ (nr. de terminale inițiale)}$$

$$\square PC = n(n-1) = 6 \cdot 5 = 30 \text{ (nr. punctelor de conexiune)}$$

$$\square N = \frac{PC}{2} = 15 \text{ (nr. liniilor de conexiune)}$$



Calculul metrajului total de CO și costul acestuia

- $3 \text{ L} \cdot 300 \text{ m} = 900 \text{ m}$
- $2 \text{ L} \cdot 1500 \text{ m} = 3000 \text{ m}$
- $2 \text{ L} \cdot 1000 \text{ m} = 2000 \text{ m}$
- $2 \text{ L} \cdot 2500 \text{ m} = 5000 \text{ m}$
- $2 \text{ L} \cdot 1529.7 \text{ m} = 3059.4 \text{ m}$
- $2 \text{ L} \cdot 1044 \text{ m} = 2088 \text{ m}$
- $2 \text{ L} \cdot 2518 \text{ m} = 5036 \text{ m}$

Total : 21083.4 m

$$C_{\text{co}} = 21083.4\text{m} \cdot 119 \text{ lei} = 2\,508\,924.6 \text{ lei}$$



Costul total al rețelei

▣ Varianta optimală de alegere a comutatoarelor pentru un terminal:

- 5 comutatoare cu 1 intr. · 98 lei = 490 lei
- 3 comutatoare cu 2 intr. · 179 lei = 537 lei
- 1 comutator cu 4 intr. + 1 comutator cu 1 intr. =
= 5 intr. → 300 lei + 98 lei = 398 lei (varianta cea mai optimală)
- 6 terminale · 398 lei (un set de comutatoare) =
= 2388 lei

Costul total al rețelei : 2508924.6 lei + 2388 lei =
= 2511312.6 lei



Extensia Rețelei

Pentru determinarea variantei optime de amplasare a terminalului “Reședința” este necesar de a analiza toate extensiile posibile față de “Președinție” .

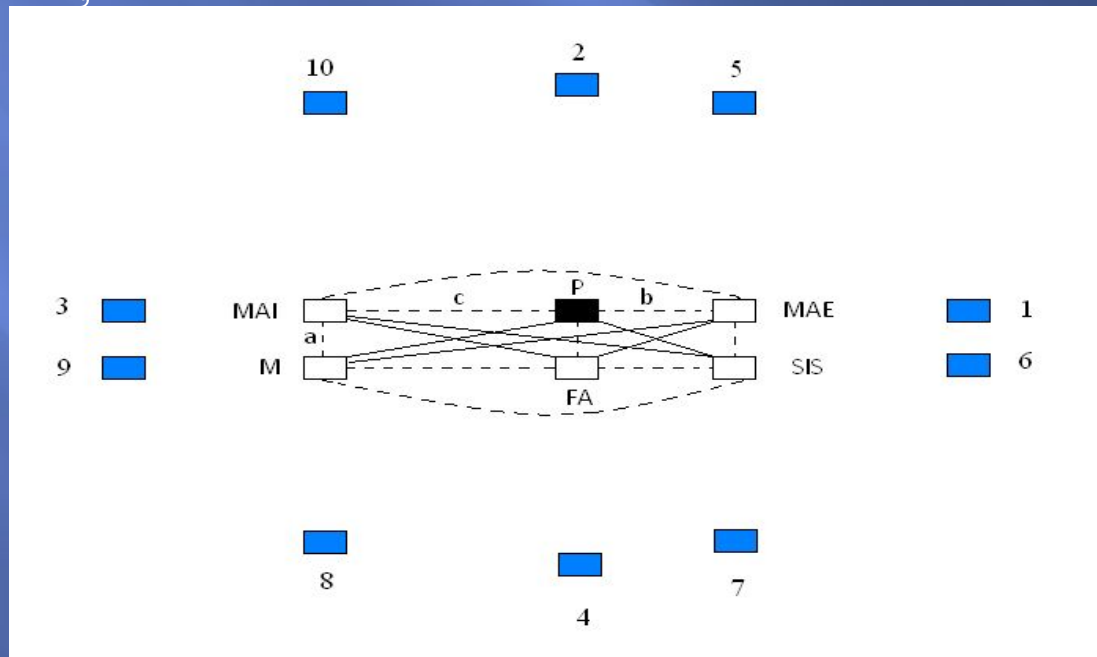



I Varianta

$$\sqrt{2500^2 + 300^2} = 2517.9\text{m}$$

$$\sqrt{1500^2 + 300^2} = 1529.7\text{m}$$

$$\sqrt{4000^2 + 300^2} = 4011.2\text{m}$$

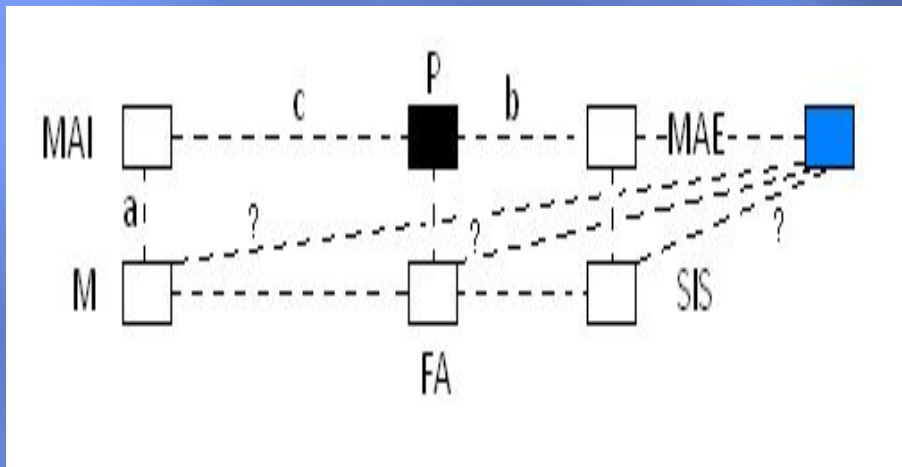

Cablu : $2517.9 + 1529.7 + 4011.2 + 1500 + 4000 + 2500 = 16058.8 \text{ m}$

Cost CO : $16058.8 \cdot 119 \text{ lei} = 1\,910\,997.2 \text{ lei}$

Cost total : $1\,910\,997.2 \text{ lei} + 98 \text{ lei} = 1\,911\,098.2 \text{ lei}$



II Varianta

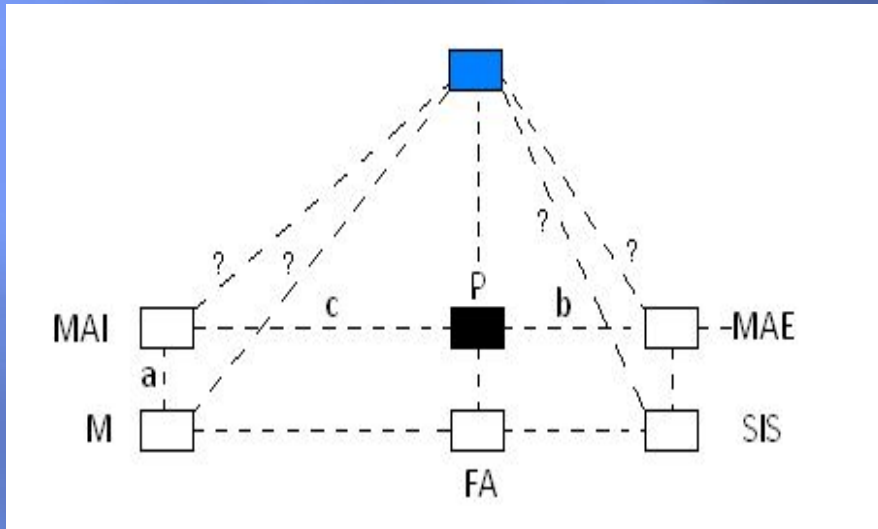

$$\sqrt{2500^2 + 1500^2} = 2915.4\text{m}$$

$$\sqrt{2800^2 + 1500^2} = 3176.4\text{m}$$

$$\sqrt{2500^2 + 1000^2} = 2692.5\text{m}$$

$$\sqrt{2800^2 + 1000^2} = 2517.9\text{m}$$

Cablu : $2915.4 + 3176.4 + 2692.5 + 2973.2 + 2500 + 2800 = 17057.5 \text{ m}$

Cost CO : $17057.5 \text{ m} \cdot 119\text{lei} = 2\,029\,842.5 \text{ lei}$

Cost total : $2\,029\,842.5\text{lei} + 98\text{lei} = 2029940.5 \text{ lei}$



III Varianta

$$\sqrt{1000^2 + 300^2} = 1044\text{m}$$

$$\sqrt{2500^2 + 300^2} = 2517.9\text{m}$$

$$\sqrt{3500^2 + 300^2} = 3512.8\text{m}$$

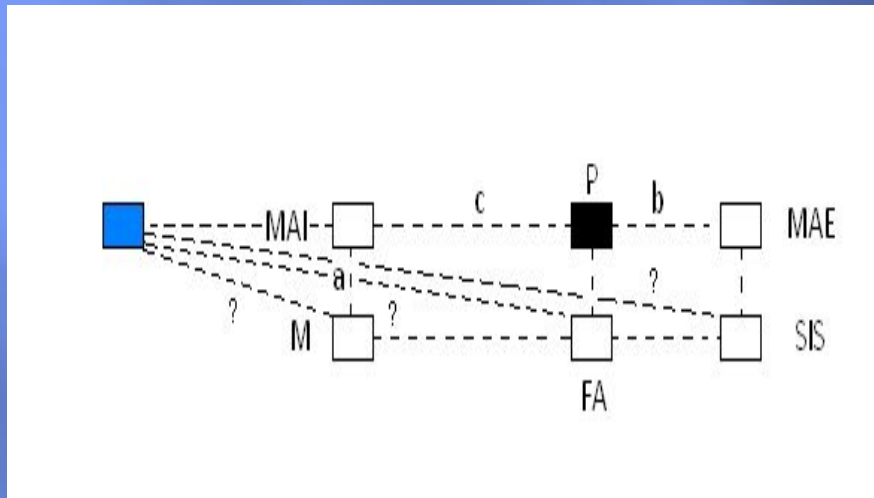

Cablu : $1044 + 2517.9 + 3512.8 + 1000 + 2500 + 3500 = 14074.7 \text{ m}$

Cost CO : $14047.7 \cdot 119 \text{ lei} = 1\,674\,889.3 \text{ lei}$

Cost total : $1\,674\,889.3 \text{ lei} + 98 \text{ lei} = 1\,674\,987.3 \text{ lei}$



IV Varianta

$$\sqrt{2200^2 + 1000^2} = 2416.6 \text{ m}$$

$$\sqrt{2500^2 + 1000^2} = 2692.5 \text{ m}$$

$$\sqrt{2200^2 + 1500^2} = 2662.7 \text{ m}$$

$$\sqrt{22500^2 + 1500^2} = 2915.4 \text{ m}$$

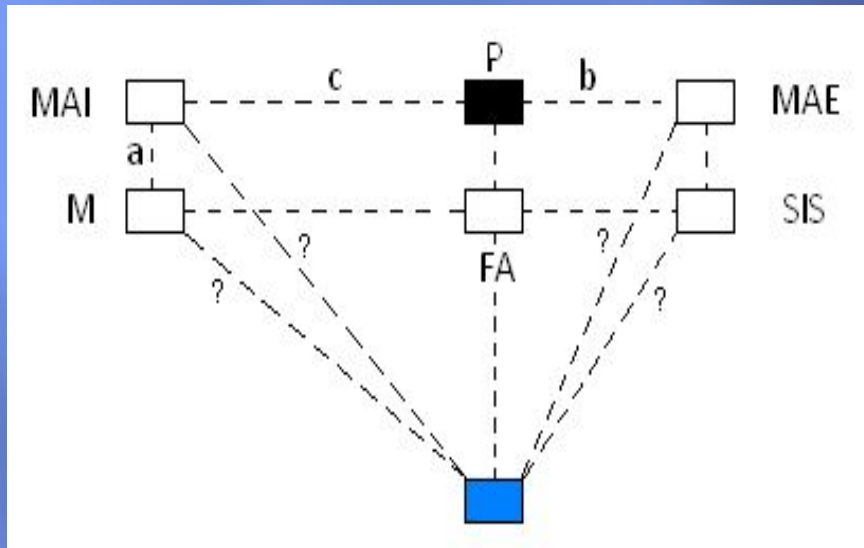

Cablu:

$$2416.6 + 2692.5 + 2662.7 + 2915.4 + 2200 + 2500 = 15387.2 \text{ m}$$

Costul CO:

$$15387.2 \cdot 119 \text{ lei} = 1831076.8 \text{ lei}$$

Costul total:

$$1831076.8 \text{ lei} + 98 \text{ lei} = 1831174.8 \text{ lei}$$



V Varianta

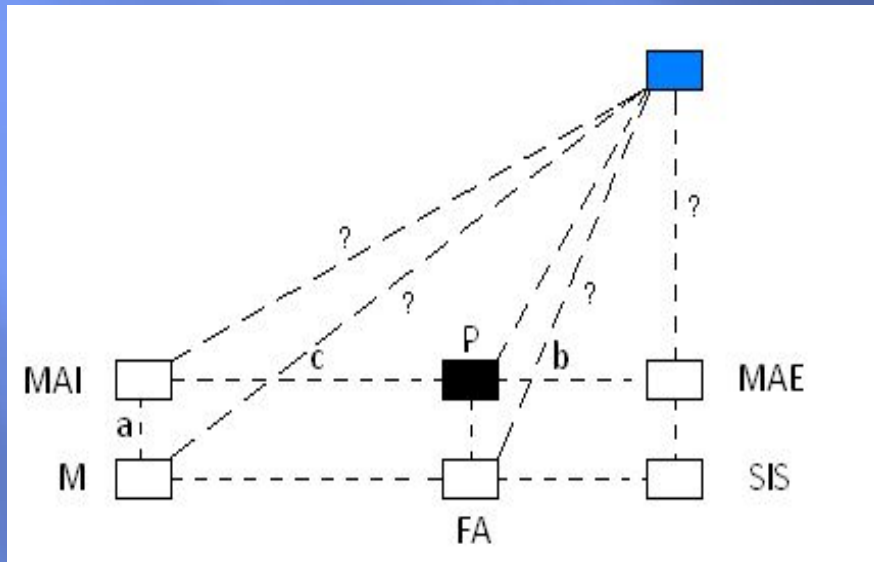

$$\sqrt{2500^2 - 1000^2} = 2291,2\text{m}$$

$$\sqrt{2591,2^2 + 1000^2} = 2777,4\text{m}$$

$$\sqrt{2500^2 + 2591,2^2} = 3600,6\text{ m}$$

$$\sqrt{2500^2 + 2291,2^2} = 3391,1\text{m}$$

Cablu : $2291,2 + 2777,4 + 3600,6 + 3391,1 + 2500 + 2591,2 = 17151,5\text{m}$

Cost CO : $17151,5\text{ m} \cdot 119\text{ lei} = 2041028,5\text{ lei}$

Cost Total : $2041028,5\text{ lei} + 98\text{lei} = 2041126,5\text{lei}$



VI Varianta

$$\sqrt{2500^2 - 300^2} = 2481.9\text{m}$$

$$2481.9 - 1000 = 1481.9\text{m}$$

$$\sqrt{1481.9^2 + 300^2} = 1511.9\text{ m}$$

$$\sqrt{3981.9^2 + 300^2} = 39993.1\text{m}$$

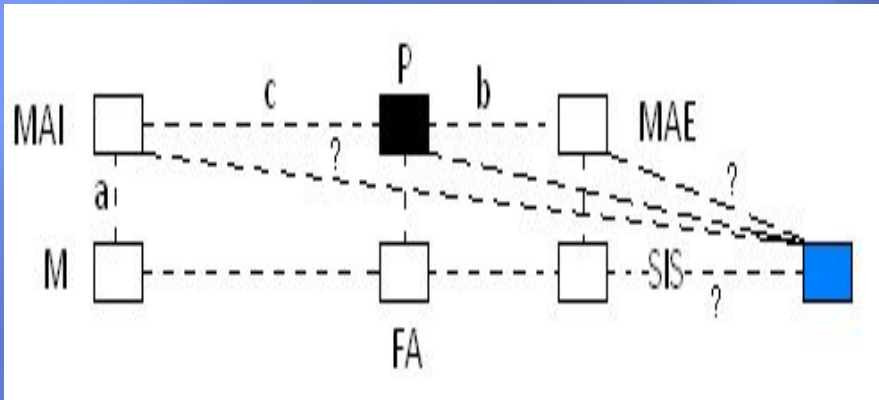

Cablu:

$$1481.9 + 1511.9 + 3993.1 + 2500 + 3981.9 + 2481.9 = 15950.7\text{m}$$

Costul:

$$15950.7\text{m} \cdot 119\text{lei} = 1898133.3\text{lei}$$

Costul total:

$$1898133.3\text{lei} + 98\text{lei} = 1898612.3\text{lei}$$



VII Varianta

$$\sqrt{2500^2 - 1000^2} - 300 = 1991.2\text{m}$$

$$\sqrt{1991.2^2 + 1000^2} = 2228.2\text{m}$$

$$\sqrt{2500^2 + 2291.2^2} = 3391.1\text{m}$$

$$\sqrt{1991.2^2 + 2500^2} = 3196\text{m}$$

Cablu : $1991.2 + 2228.2 + 3391.1 + 3196 + 2500 + 2291.2 = 15597.7 \text{ m}$

Cost CO : $15597.7 \text{ m} \cdot 119 \text{ lei} = 1856126.3 \text{ lei}$

Cost Total: $1856126.3 \text{ lei} + 98 \text{ lei} = 1856224.3 \text{ lei}$

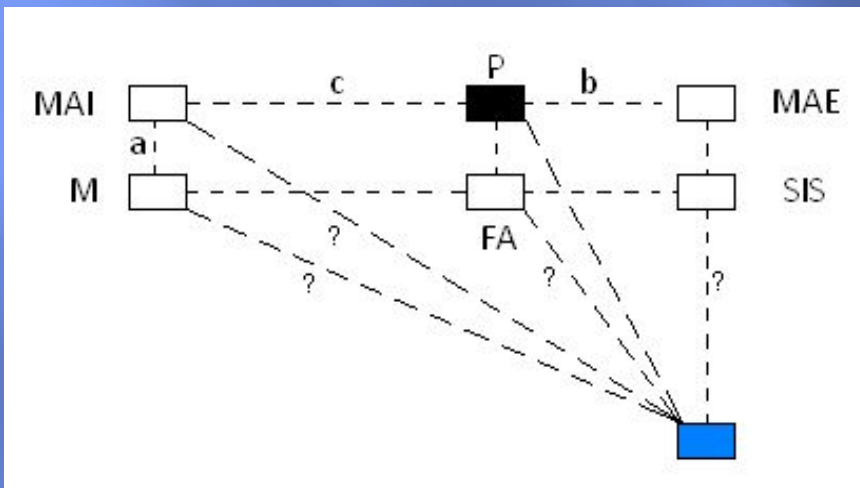



VIII Varianta

$$\sqrt{2500^2 - 1500^2} - 300 = 1700\text{m}$$

$$\sqrt{1700^2 + 1500^2} = 2267.1\text{m}$$

$$\sqrt{2000^2 + 2500^2} = 3201.5\text{m}$$

$$\sqrt{1700^2 + 2500^2} = 3023.2\text{m}$$

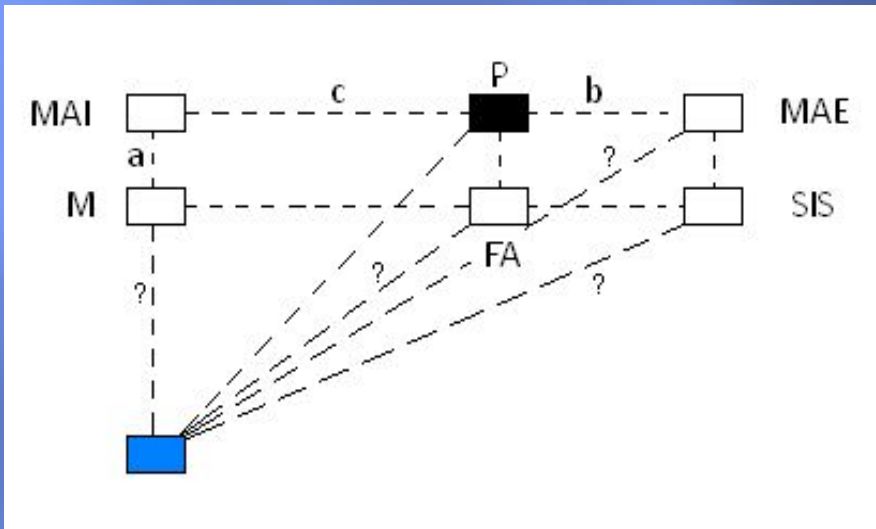

Cablu:

$$1700 + 2267.1 + 3201.5 + 3023.2 + 2500 + 2000 = 14691.8\text{m}$$

Costul:

$$14691.8\text{m} \cdot 119\text{lei} = 1748324.2\text{lei}$$

Coatul total:

$$1748324.2\text{lei} + 98\text{lei} = 1748422.2\text{lei}$$



IX Varianta (Cea mai optimala)

$$\sqrt{2500^2 - 300^2} = 2481.9\text{m}$$

$$2481.9 - 1500 = 981.9\text{m}$$

$$2481.9 + 1000 = 3481.9\text{m}$$

$$\sqrt{981.9^2 + 300^2} = 1026.7\text{m}$$

$$\sqrt{3481.9^2 + 300^2} = 3494.8\text{m}$$

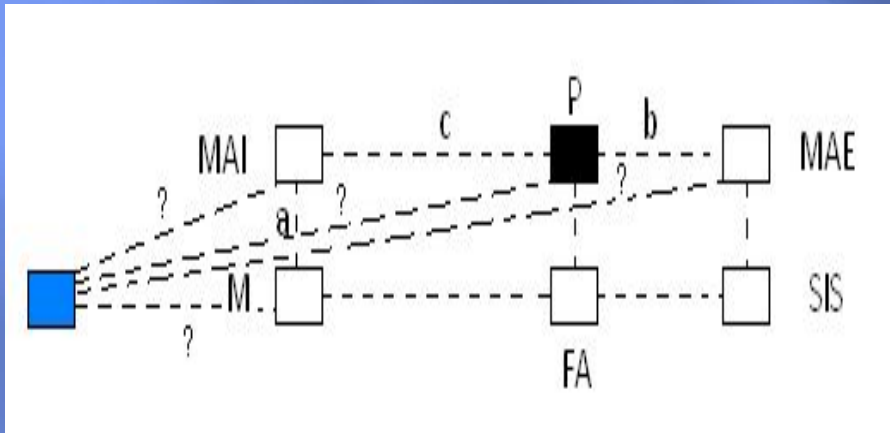

Cablu : $2481.9 + 981.9 + 3481.9 + 1026.7 + 3494.8 + 2500 = 13967.2 \text{ m}$

Cost CO :

$$13967.2\text{m} \cdot 119 \text{ lei} = 1662096.8 \text{ lei}$$

Cost Total: $1662096.8 \text{ lei} + 98 \text{ lei} = 1662194.8 \text{ lei}$



X Varianta

$$\sqrt{2500^2 - 1500^2} = 2000\text{m}$$

$$\sqrt{2300^2 + 1500^2} = 2745.9\text{m}$$

$$\sqrt{2300^2 + 2500^2} = 3397\text{m}$$

$$\sqrt{2000^2 + 2500^2} = 3201.5\text{m}$$

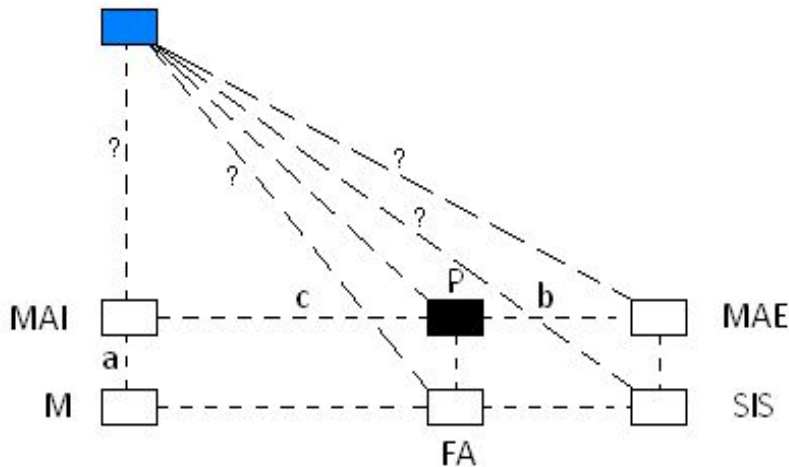

Cablu:

$$2000 + 2745.9 + 3397 + 3201.5 + 2500 + 2300 = 16144.4\text{m}$$

Costul:

$$16144.4\text{lei} \cdot 119\text{lei} = 1921183.6\text{lei}$$

Costul total:

$$1921183.6\text{lei} + 98\text{lei} = 1921281.6\text{lei}$$



Compararea sinecostului unui terminal al rețelei inițiale cu

costul terminalului de extensie



- Sinecostul unui terminal al rețelei inițiale:
 $25111312,6/6=418552,1$ lei (pentru 1 terminal)
- Costul terminalului de extensie: 1662194,8
- Aflarea coeficientului: $1662194,8/418552,1=3,97$

$$\gamma = 3,97$$



Viziune - Misiune

Motto : Dezvoltare continua

Viziune :

“ISISCOM” va deveni primul furnizor de servicii de TLC în topul preferințelor clienților de afaceri din R.M.

Misiune :

“ISISCOM” se va angaja în furnizarea de servicii de TLC care să răspundă cerințelor consumatorilor și clienților de afaceri din R.M.



Strategii de marketing

Strategii de produs :

- ❑ Servicii de mesagerie vocală ;
- ❑ Servicii de conferință ;
- ❑ Televiziune ;
- ❑ Servicii de date (Security Link – servicii de comunicații de mare viteză care permite în orice moment de timp transferul datelor într-un timp foarte scurt, între 2 locații specificate de către client)

A fi client *ISISCOM* înseamnă a avea soluții complete de TLC pentru necesitățile prezente și viitoare.

“Întreprinderile bogate nu fac marketing pentru că au bani, ci au bani pentru că fac marketing .”



Concluzii

- ▣ În proiectul dat am realizat interconectarea punctelor strategice din R.M. în baza topologiei „plasă”.

După extensiunea rețelei cu terminalul Reședința R am constatat că costul terminalului de extensiune este mai mare ca costul terminalului inițial ($\gamma = 3,97$).

Deci este foarte important de planificat din start rețeaua cu rezervă, ca mai apoi să putem implementa un nou terminal fără mari cheltueli.



ISISCOM

Mulțumim
pentru atenție!