

RADIOGRAPHIC TESTING

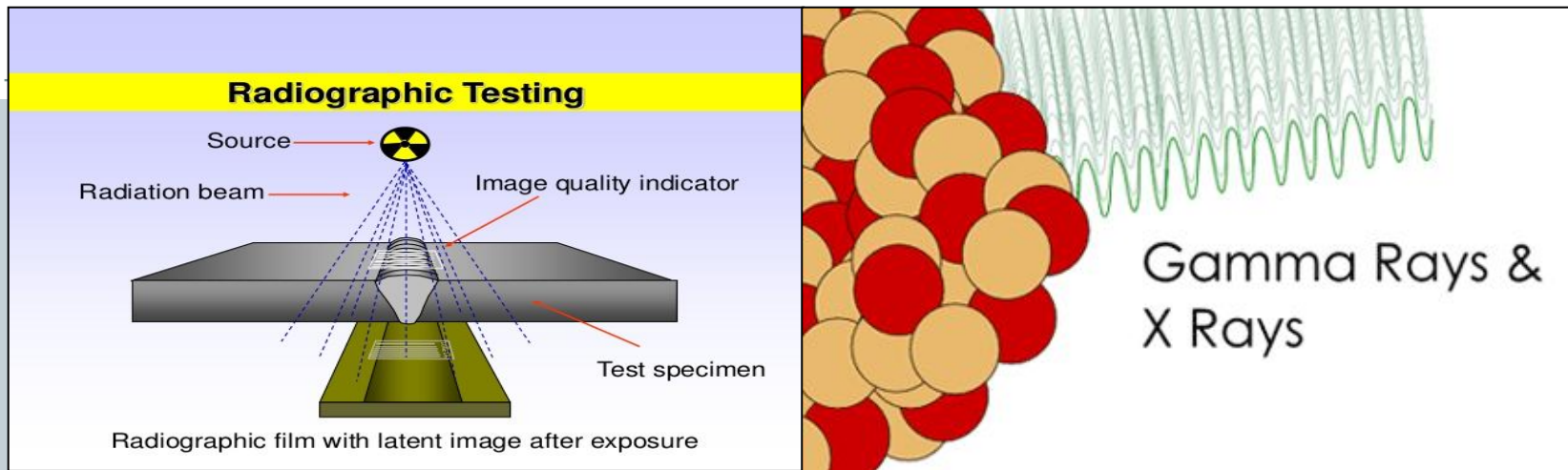

Prepared by students: Khalafov R.,
Zelentsov D., Madaminov N.,
Kunashenko S.

Content

2

- Introduction
- Theory and principles
- Radiographic equipment and accessories
- Variables
- Techniques and procedures
- Radiographic evaluation
- Applications
- Advantages and limitations of radiography

Introduction

3

- This presentation shows information about the NDT method of radiographic inspection or radiography.
- Radiography uses penetrating radiation that is directed towards a component.
- The component stops some of the radiation. The amount that is stopped or absorbed is affected by material density and thickness differences.
- These differences in “absorption” can be recorded on film, or electronically.

Theory and principles

4

Radiation is Absorbed and Scattered by Material

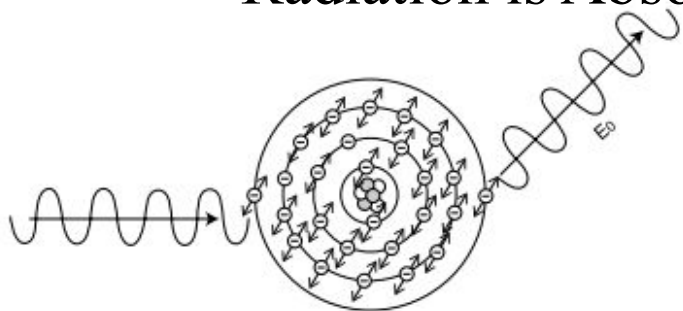

b) Rayleigh or Coherent Scattering

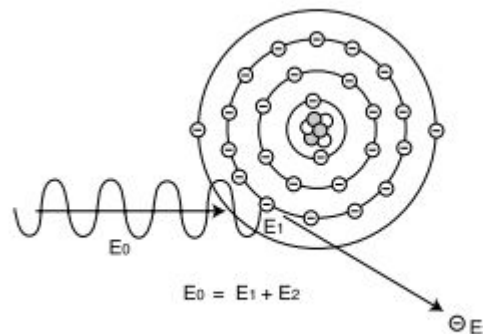

a) Photoelectric Effect

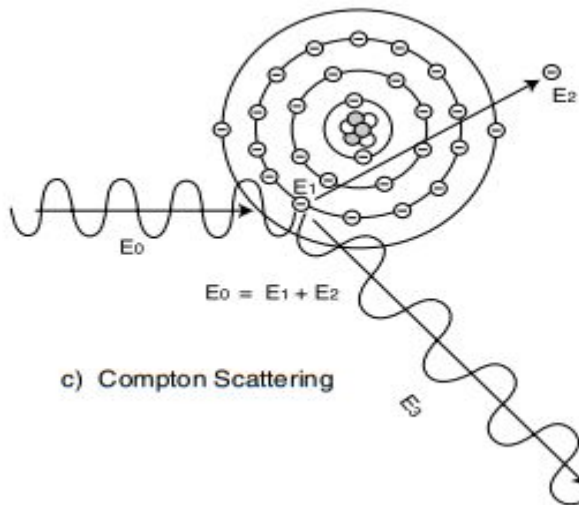

c) Compton Scattering

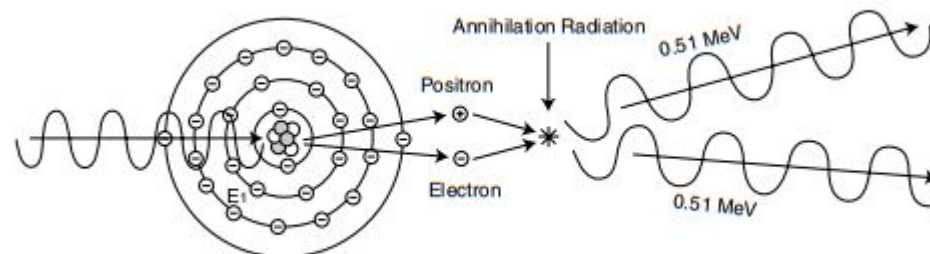

d) Pair Production

Theory and principles

5

Radiation Travels in Straight Lines and at the Speed of Light

Radiation Exhibits Energy

Radiation Has No Electrical Charge

Radiation is Not Particulate

Radiation Ionizes Matter

x- and Gamma Radiation Cannot be Focused

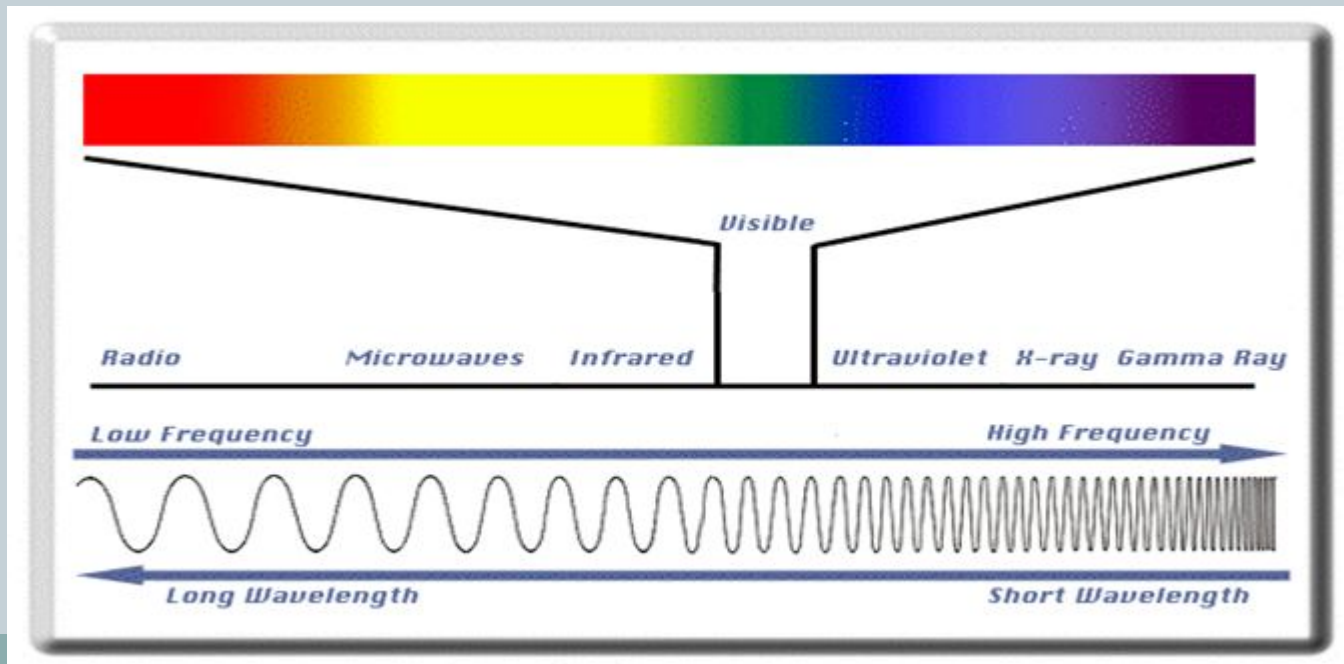

General Principles of Radiography

6

The part is placed between the radiation source and a piece of film. The part will stop some of the radiation. Thicker and more dense area will stop more of the radiation.

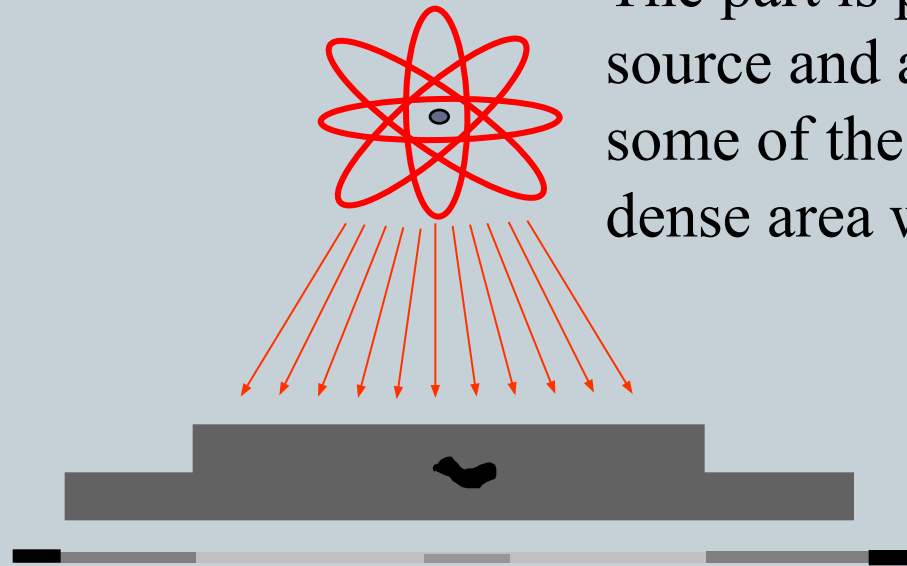

X-ray film

The film darkness (density) will vary with the amount of radiation reaching the film through the test object.

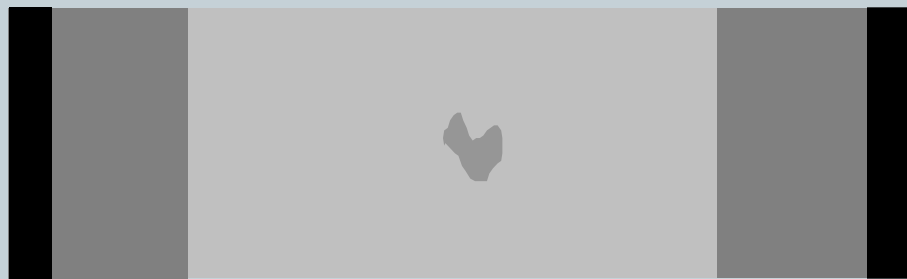

Top view of developed film



= less exposure

= more exposure

General Principles of Radiography

7

- The energy of the radiation affects its penetrating power. Higher energy radiation can penetrate thicker and more dense materials.
- The radiation energy and/or exposure time must be controlled to properly image the region of interest.

Thin Walled Area

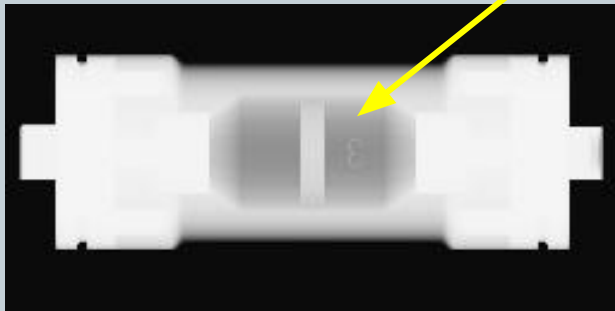

Low Energy Radiation

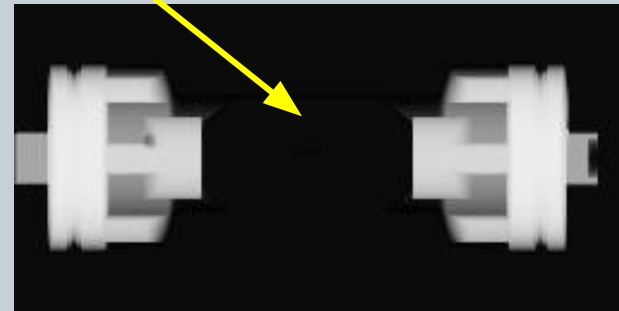

High energy Radiation

Gamma Radiography

8

- Gamma rays are produced by a radioisotope.
- A radioisotope has an unstable nuclei that does not have enough binding energy to hold the nucleus together.
- The spontaneous breakdown of an atomic nucleus resulting in the release of energy and matter is known as radioactive decay.

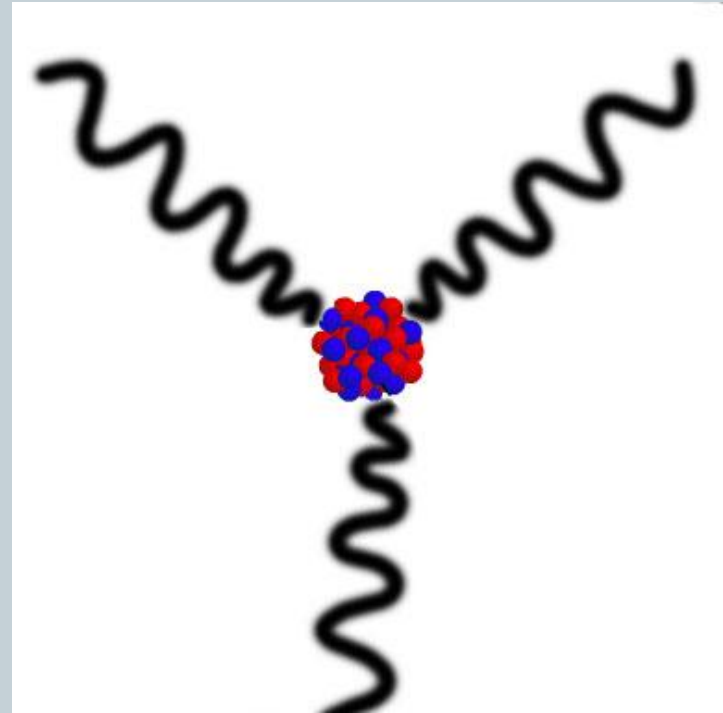

Gamma Radiography

9

Unlike X-rays, which are produced by a machine, gamma rays cannot be turned off. Radioisotopes used for gamma radiography are encapsulated to prevent leakage of the material.

The radioactive “capsule” is attached to a cable to form what is often called a “pigtail.”

The pigtail has a special connector at the other end that attaches to a drive cable.

Iridium 191 wafers before activation & encapsulation



Welded Capsule containing source material

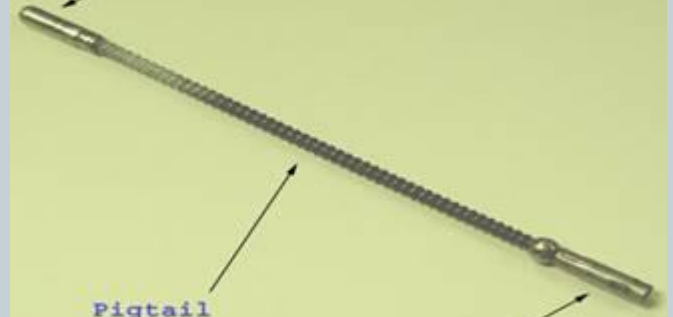

Pigtail

Pigtail connector

Gamma Radiography

10

A device called a “camera” is used to store, transport and expose the pigtail containing the radioactive material. The camera contains shielding material which reduces the radiographer’s exposure to radiation during use.

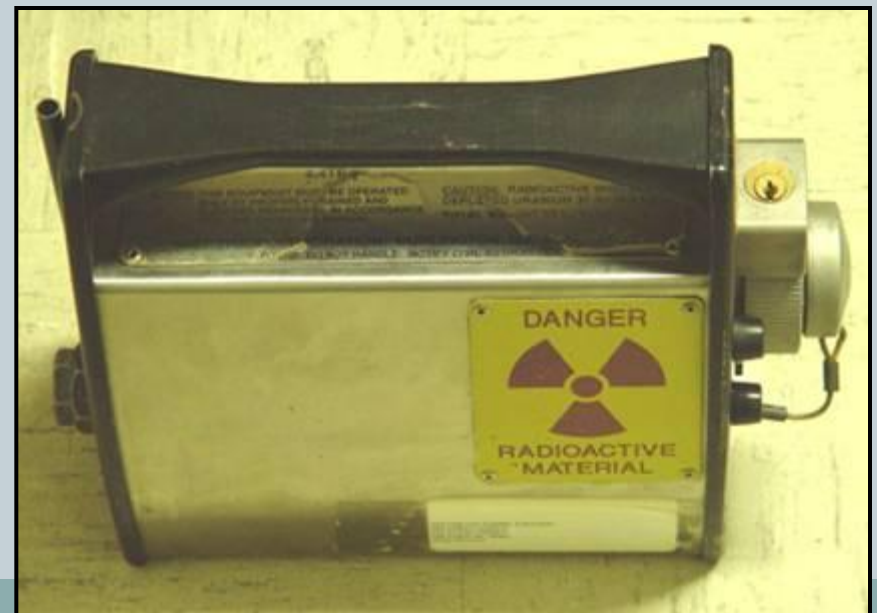
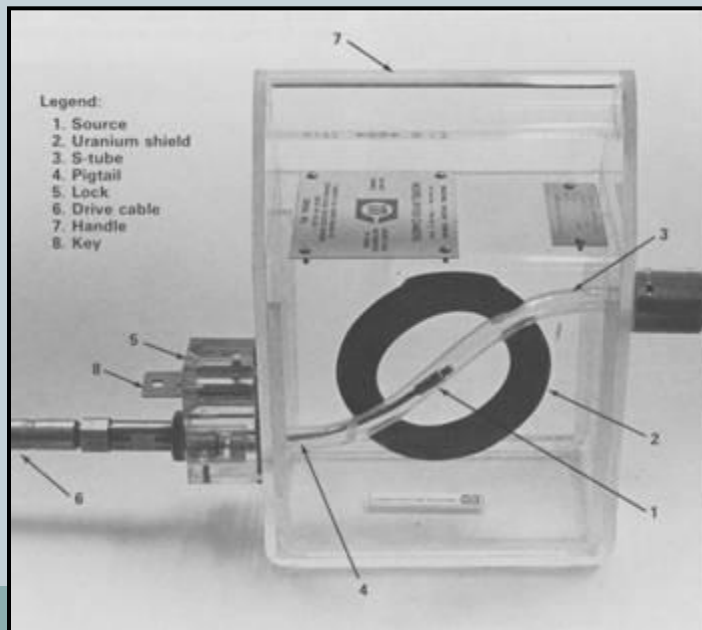

Gamma Radiography

11

A hose-like device called a guide tube is connected to a threaded hole called an “exit port” in the camera.

The radioactive material will leave and return to the camera through this opening when performing an exposure!

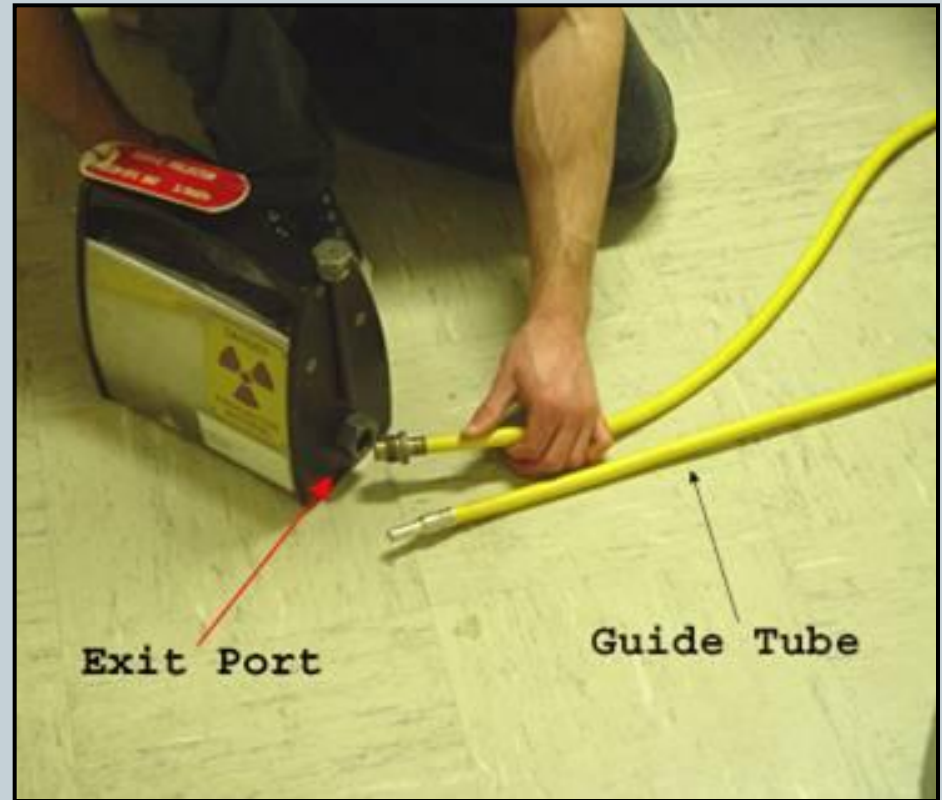

Gamma Radiography

12

A “drive cable” is connected to the other end of the camera. This cable, controlled by the radiographer, is used to force the radioactive material out into the guide tube where the gamma rays will pass through the specimen and expose the recording device.

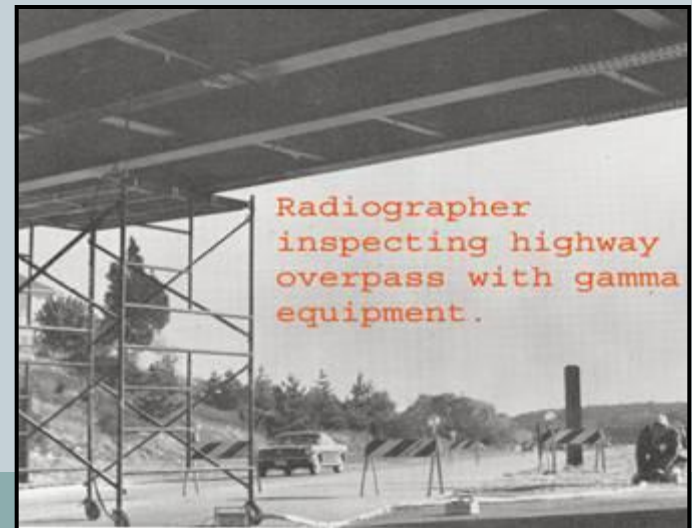
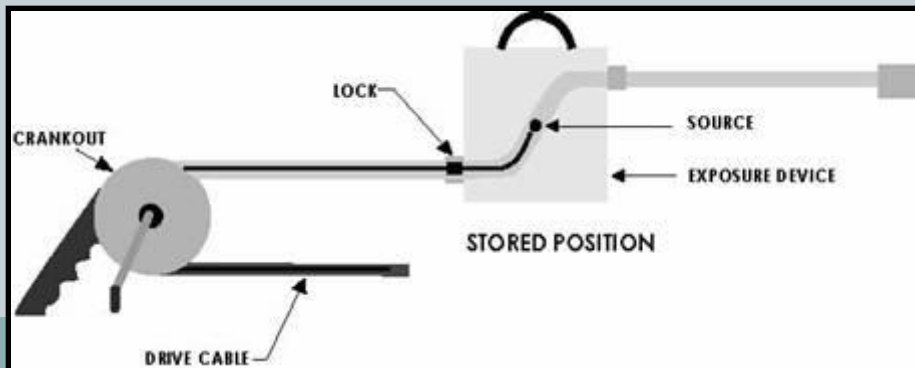

X-ray Radiography

13

Unlike gamma rays, x-rays are produced by an X-ray generator system. These systems typically include an X-ray tube head, a high voltage generator, and a control console.



X-ray Radiography

14

- X-rays are produced by establishing a very high voltage between two electrodes, called the anode and cathode.
- To prevent arcing, the anode and cathode are located inside a vacuum tube, which is protected by a metal housing.

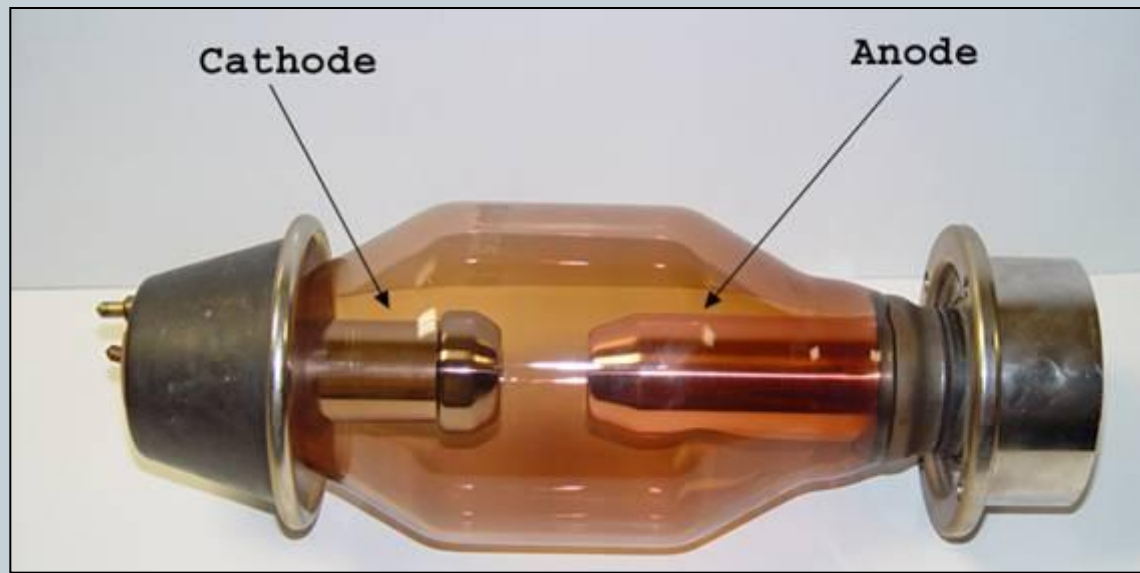

Variables of radiography

15

Of all the nondestructive testing methods, radiography certainly has the most variables. These variables include:

- Energy
- Exposure time
- mA (x-ray) or curies (gamma ray)
- Material type and density
- Material thickness
- Type of film
- Screens used
- Film processing
- Film density
- Distance from rad. Source to the object
- Distance from the object to the film

Variables of radiography

16

- In order to control these variables so that the benefits can be maximized for each one, a technique chart should be used. Unfortunately, there are still many radiographs taken by the “trial and error” technique.
- The best way to produce a high-quality radiograph is through the use of **exposure charts**

Using of exposure charts

17

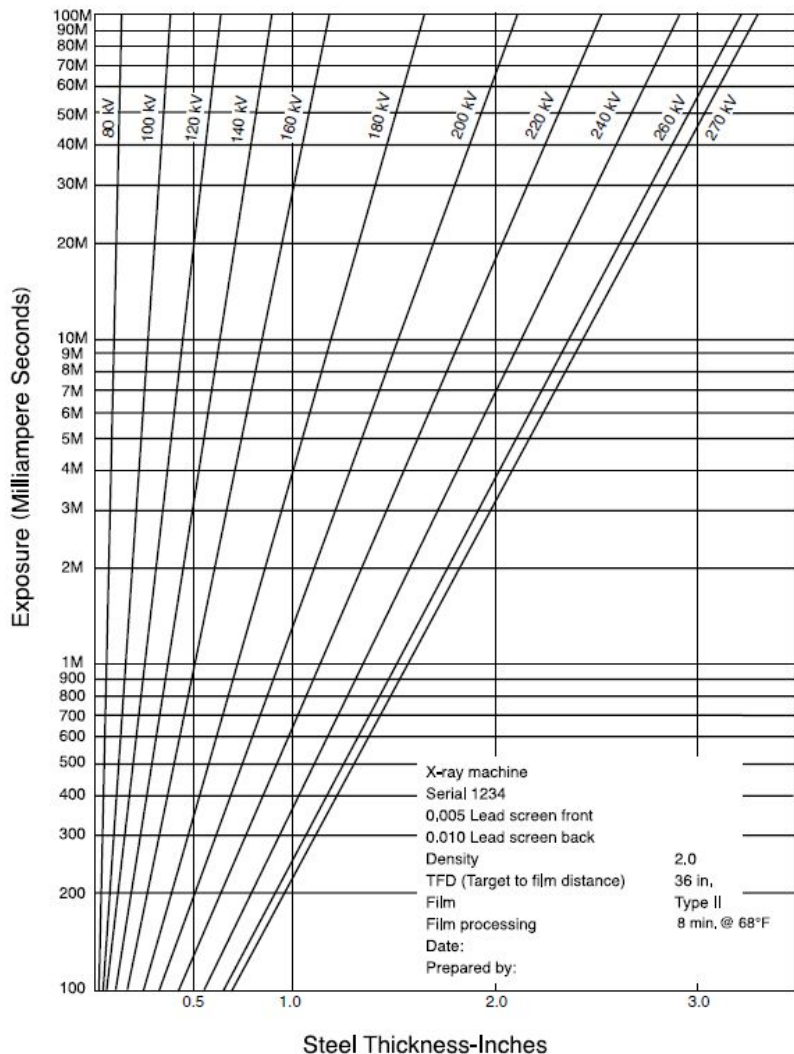

X-ray

1. Verify the material type
2. Project a straight line vertically from that thickness up to the top of the technique chart and notice that there are a number of energies that can be used
3. Choose the exposure time and intensity combined in units of milliampere seconds (mAs)

Using of exposure charts

18

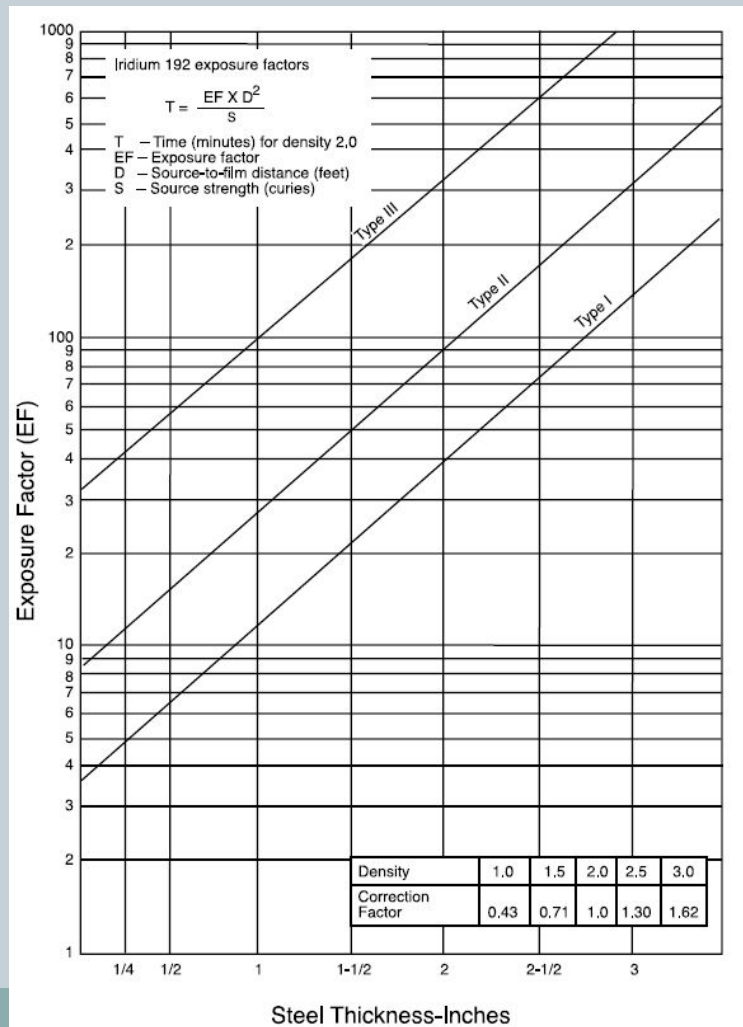

Gamma ray

1. To project the material thickness vertically until it intersects with the film type being used
2. Draw a line horizontally to the vertical axis. From that axis, the exposure factor (EF) is determined.
3. An exposure time in minutes can be easily calculated by the equation

Source to film distance

19

- Source to film distance (SFD) is also referred to as the target to film distance (TFD). The TFD generally applies when using an x-ray source and the SFD applies when radioactive isotopes are used.
- There is a mathematical relationship between the exposure time and the distance:

T_1 = original exposure time
derived from the technique
chart

T_2 = new exposure time

$$\frac{T_1}{T_2} = \frac{D_1^2}{D_2^2}$$

D_1 = original distance

D_2 = new distance

Techniques and procedures

20

- Single wall exposure, single view technique

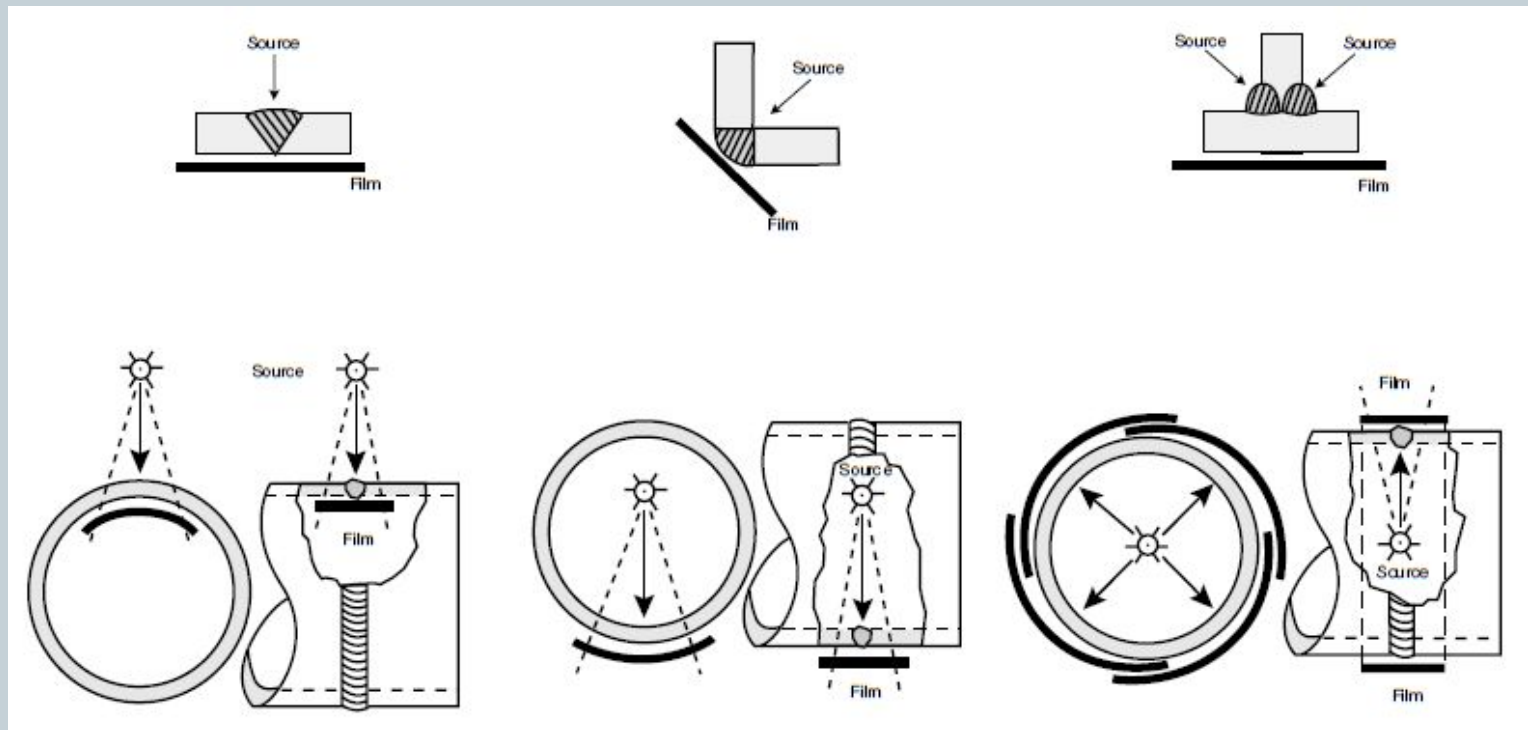

Techniques and procedures

21

- Double wall exposure, single view technique

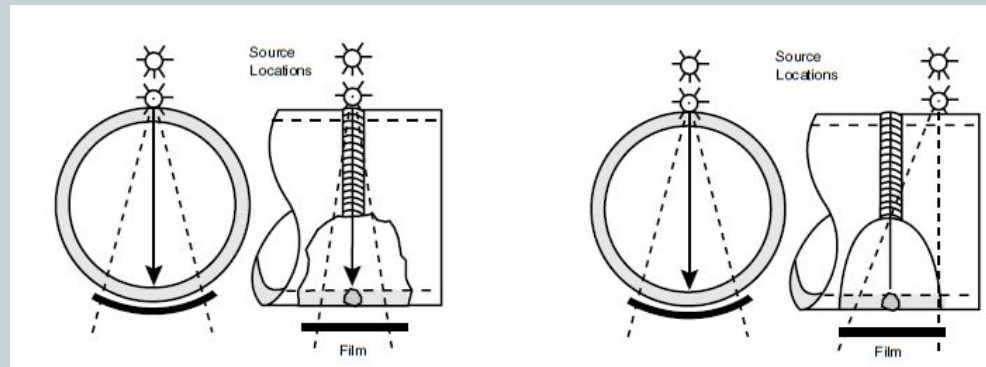

- Double wall exposure, double view technique

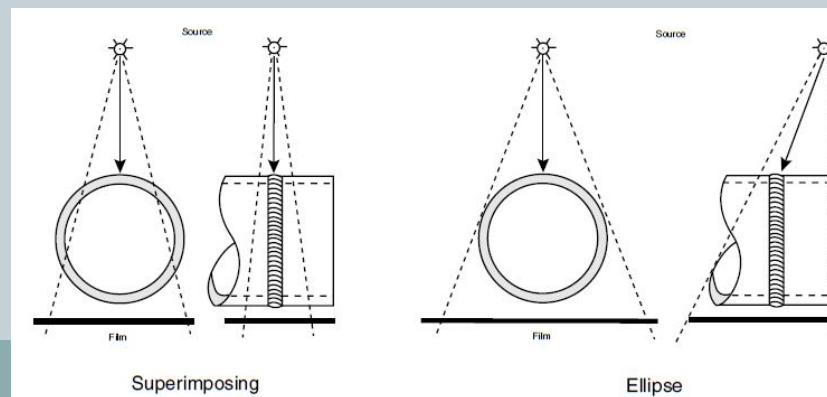

Procedure

22

- Understand the codes, specifications, and customer requirements thoroughly
- Develop a technique based on the thickness and type of material
- Prepare a shooting sketch
- In the darkroom, carefully place the radiographic film in the cassette with the proper lead screens
- Place the film under the area of interest
- Ensure that the correct source to film distance is being employed
- Place the appropriate station markers and identification numbers in the area of interest to assure easy correlation with a discontinuity if one is detected
- Set up the exposure parameters
- Make the exposure
- In the darkroom, unload and process the film
- Evaluate the film for artifacts
- Evaluate the film for compliance
- Complete a report and store the film

Radiographic Film

23

- *Class I* is described as extra-fine grain, low speed, with very high contrast capabilities. This film is generally used for lower-density materials and can be used with or without lead screens.
- *Class II* is a fine-grain, medium-speed, high-contrast film that is also used for the lower-density materials with low- and medium-energy radiation. This film classification tends to be more widely used than the Class I since it provides very good definition, has fine grain, and is slightly higher in film speed than Class I. It can also be used with or without lead screens.
- *Class III* is a high-speed film, and therefore requires shorter exposure times. It is typically used for x-rays or gamma rays with higher energies, and can be used with or without lead screens. It is considered a medium-contrast film with high graininess.

Film processing

24

- **Developing** Developers are alkaline solutions that change the latent or chemically stored image in the radiographic emulsion into a visible image, resulting in various shades of gray or black
- **Stop developing** The film can be taken out of the developer and placed into a water bath for several minutes, or it can be placed in an acidic solution called stop bath
- **Fixing** Fixer clears out the unexposed silver halide crystals remaining in the film and, second, it fixes or hardens the image. After fixing, the film goes into a water rinse for a period of time, typically 30 minutes in order to remove any remaining traces of the developer or the fixer
- **Drying the film** Normally done in a warm air recirculating drier designed for this purpose

Density of the film

25

- Film density is defined as the quantitative measure of film blackening as a result of exposure and processing
- It can be expressed mathematically as follows:

$$D = \log \frac{I_0}{I_t}$$

where: D = density I_0 = light incident on the film I_t = light intensity transmitted through the film

- If a film is exposed and the resultant film density is one, the amount of light that passes through the film is 10% of the incident light. For a film density of **2.0**, **only 1%** of the incident light passes through. A film density of **3.0** permits **0.1%** of the incident light to pass through, a film density of **4.0**, **0.01%**, and so on.

Radiographic evaluation

26

- Interpretation of radiographs requires hours of reviewing and understanding the different types of images.
- The radiographic interpreter should always wear cloth gloves (preferably cotton) when evaluating radiographs.
- Magnifiers are encouraged when they can assist in the proper detection and identification of the different discontinuities.

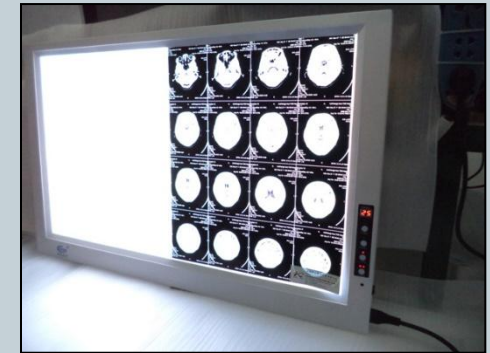

Image Quality

27

- Image quality is critical for accurate assessment of a test specimen's integrity.
- Various tools called Image Quality Indicators (IQIs) are used for this purpose.
- There are many different designs of IQIs. Some contain artificial holes of varying size drilled in metal plaques while others are manufactured from wires of differing diameters

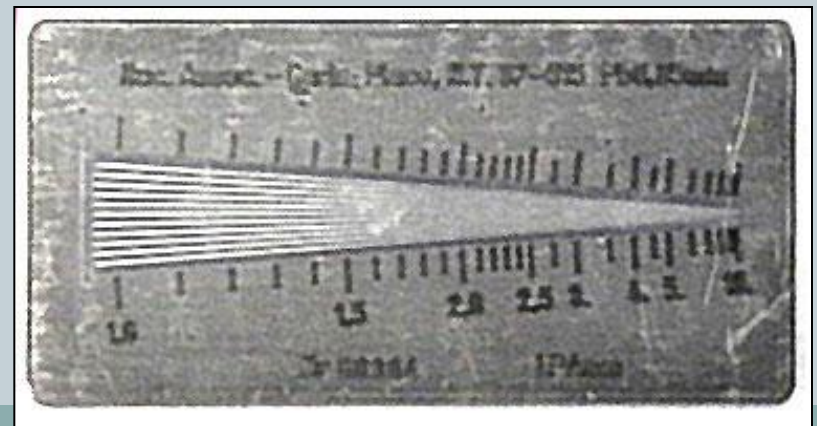
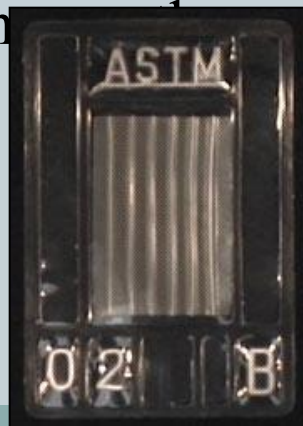
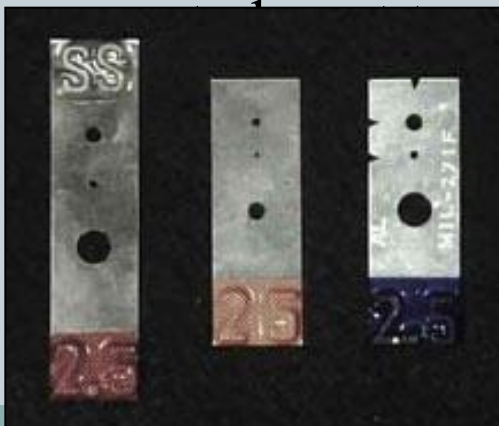

Image Quality

28

- IQIs are typically placed on or next to a test specimen.
- Quality typically being determined based on the smallest hole or wire diameter that is reproduced on the image.

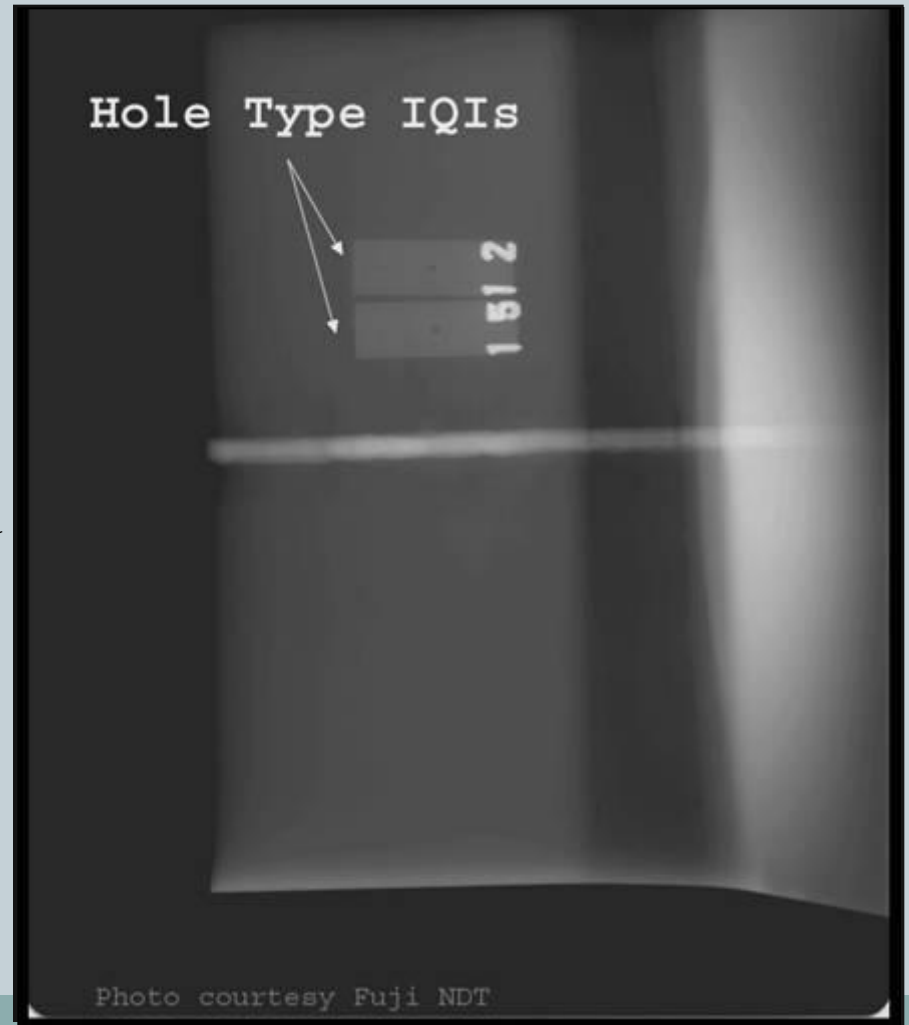
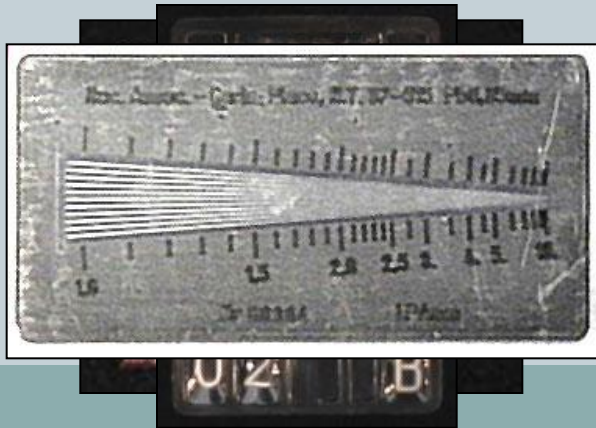

Photo courtesy Fuji NDT

Evaluation for Artifacts

29

Artifact - a false indication on a radiograph arising from, but not limited to, faulty manufacture of the film, storage, handling, exposure, or processing.

Film artifacts that are caused prior to processing	Artifacts that are caused during the processing of the Film
<ul style="list-style-type: none">• Lead screen marks• Static marks• Film scratches• Exposure to light• Fog due to exposure to low levels of light or aging• Finger marks• Pressure marks• Crimp marks	<ul style="list-style-type: none">• Pressure marks (from rollers in an automatic processor)• Chemical and delay streaks• Pi lines (in automatic processors)• Chemical spots• Dirt

Evaluation for Discontinuities

30

Discontinuity conditions that are normally found in welds include those in the following subsections, listed in order of severity.

Cracks

There are many different types of cracks that are classified by their orientation and location. They will always appear as dark, irregular, linear indications in a radiograph and are the most serious of all discontinuities.

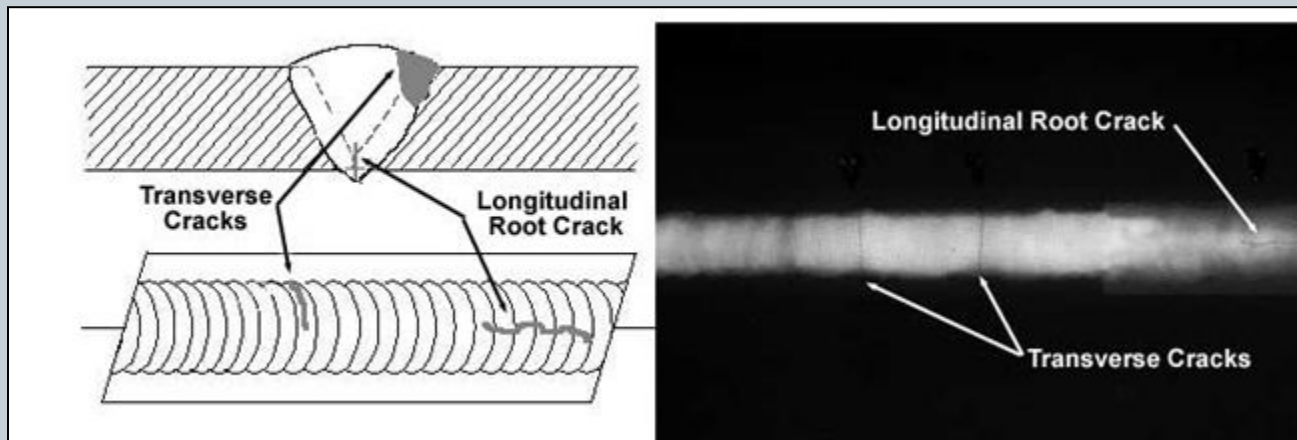

Evaluation for Discontinuities

31

Lack of Fusion

This serious discontinuity results from an absence of metallurgical fusion, either between a weld pass and the base material (weld edge prep) or between two successive weld passes. Lack of fusion is usually very narrow, linear, and tends to be straighter than the crack.

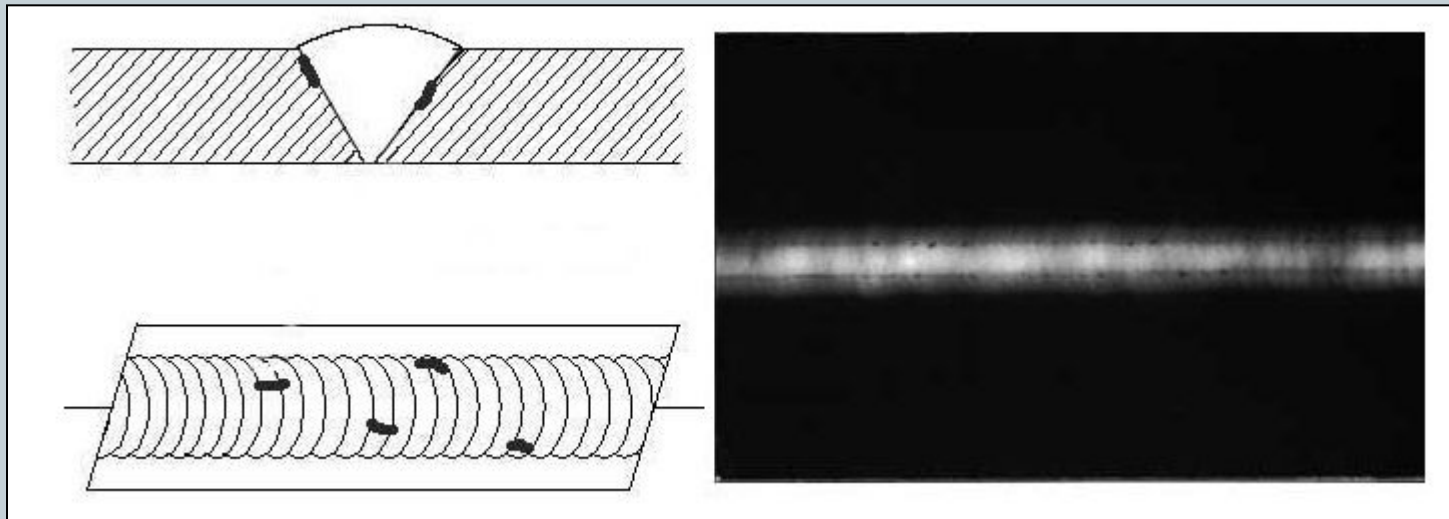

Evaluation for Discontinuities

32

Incomplete Penetration

This discontinuity is an absence of weld metal or an area of “nonfusion” in the root pass of the weld. Its appearance is very straight, dark, linear, and usually “crisp” in sharpness.

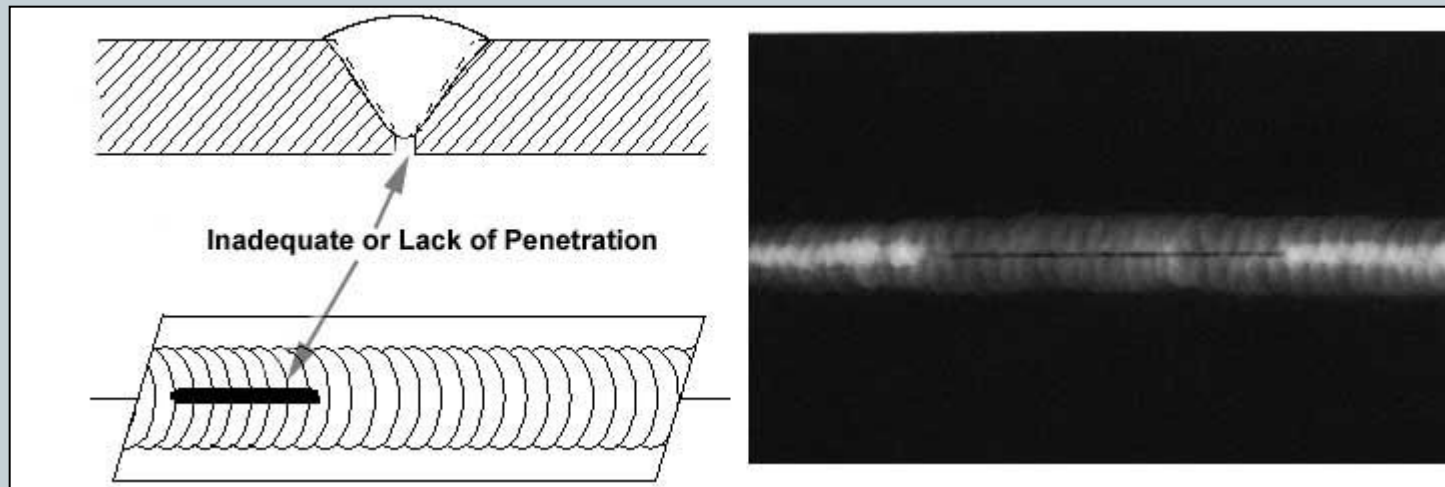

Evaluation for Discontinuities

33

Inclusions (Dense and Less Dense)

Inclusions are basically materials that have been entrapped in the weld that do not belong there. They will have a variety of shapes and dimensions ranging from short and isolated to linear and numerous. The lighter-density inclusions will result in a darker image on the radiograph and the more dense inclusions, such as tungsten, as a lighter image.

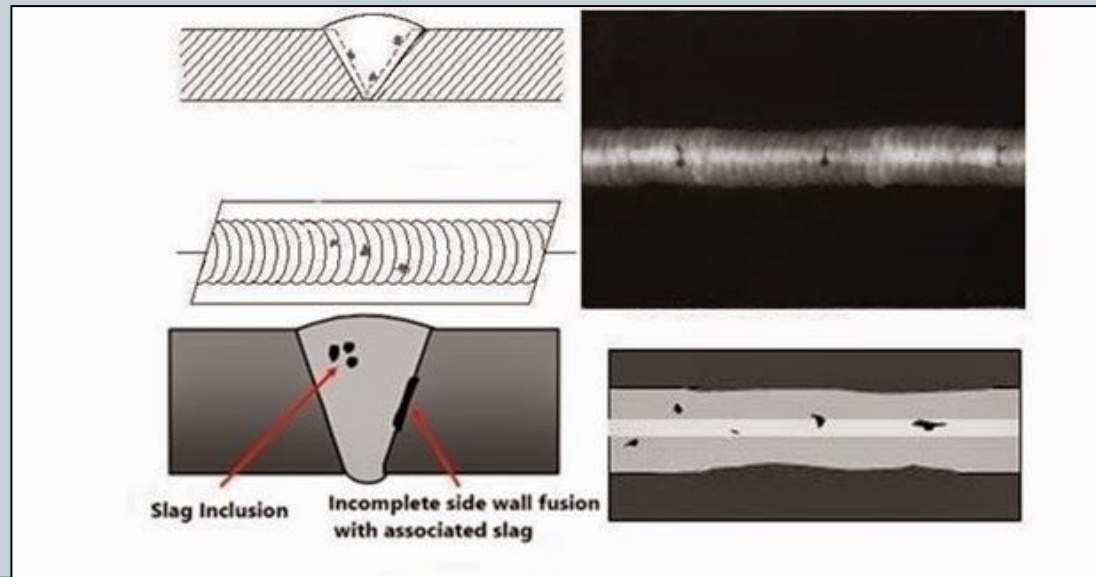

Evaluation for Discontinuities

34

Porosity

When gas is trapped in a weld metal, the void-type condition created is referred to as gas or porosity. Porosity comes in different shapes (globular, tailed, elongated) and distributions (linearly aligned, clustered, isolated, scattered). Porosity will always appear darker, since they are gas filled, and are the easiest of all weld discontinuities to detect.

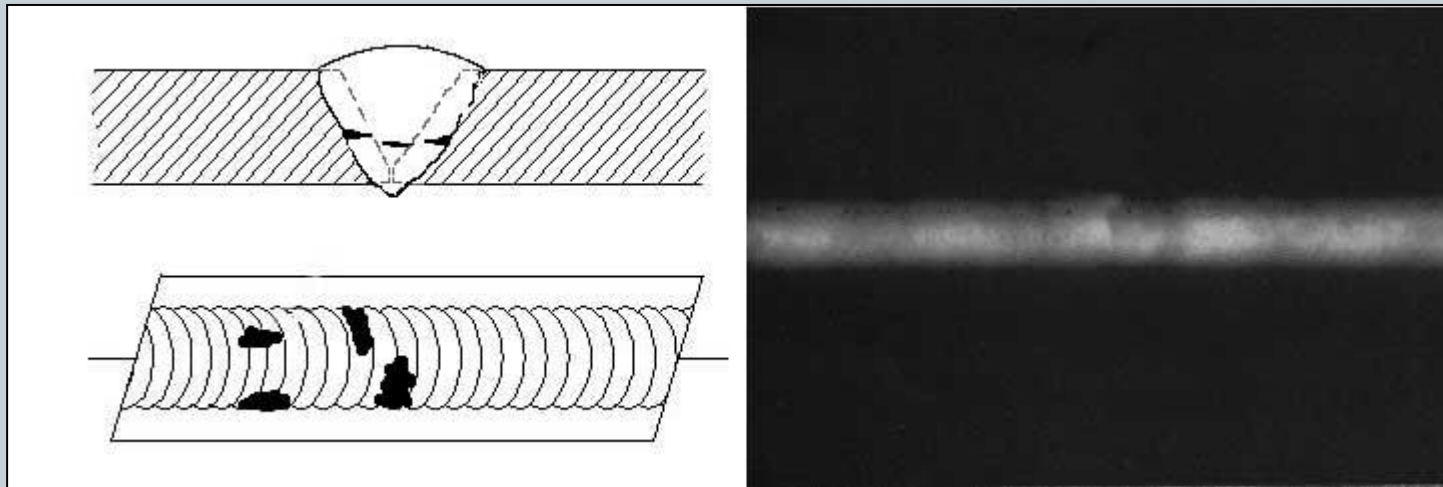

Geometric Conditions

35

There are also geometric conditions that can occur in welds that are observable in a radiograph and should be further addressed by visual examination and dimensional checks.

These geometric conditions include the following: concavity, convexity, undercut, underfill and overreinforcement.

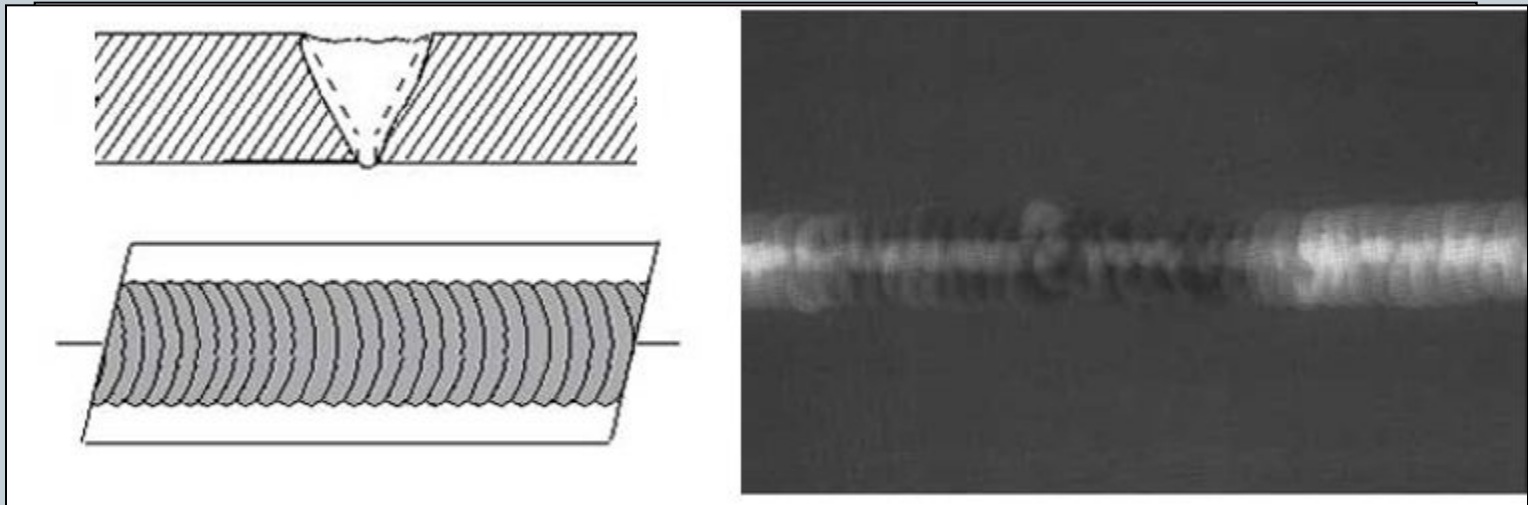

Casting Discontinuities

36

Hot tears and cracks

Hot tears and cracks – both serious ruptures or fissures that typically occur in an isolated zone due to the high stresses that build up during the cooling of the casting. On a radiograph, both conditions appear linear and branch-like and are most likely to be in or near an area of thickness change, where the different rates of cooling cause stresses to build up.

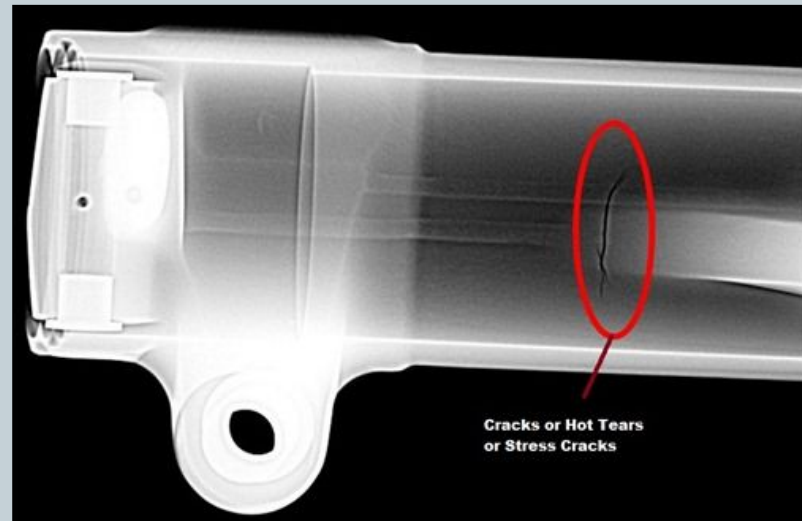
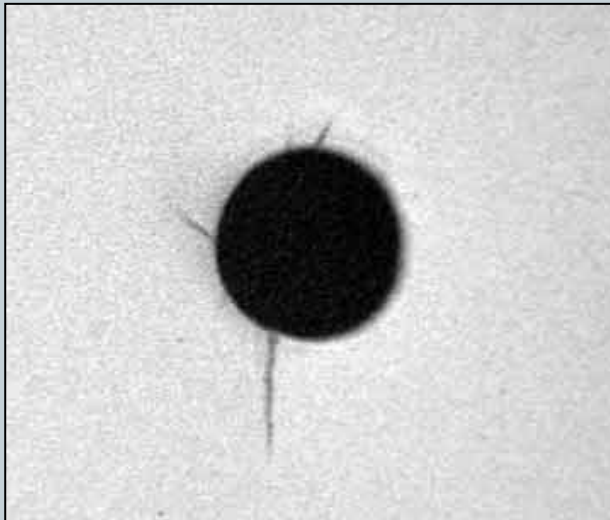

Casting Discontinuities

37

Shrinkage

Shrinkage – usually in the form of a zone of minute fissures as a result of stresses during cooling. Shrinkage comes in various shapes. Microshrinkage is feathery in appearance and the change in density is often quite minor.

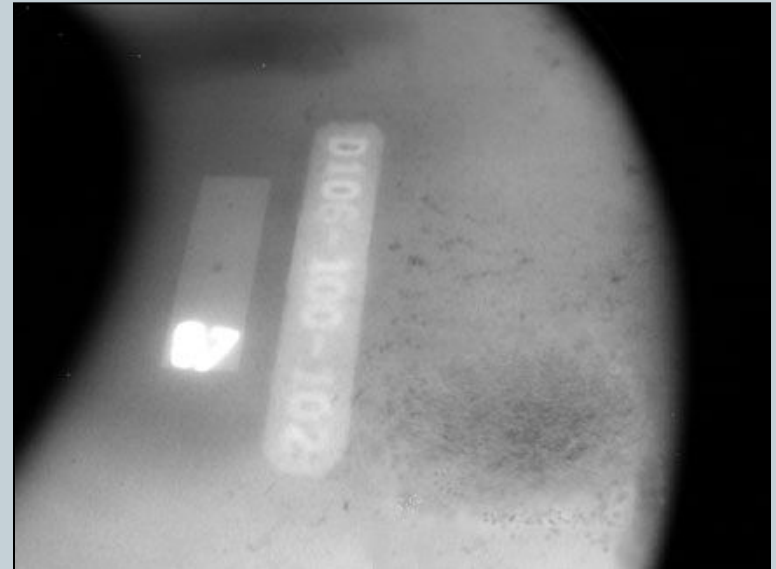
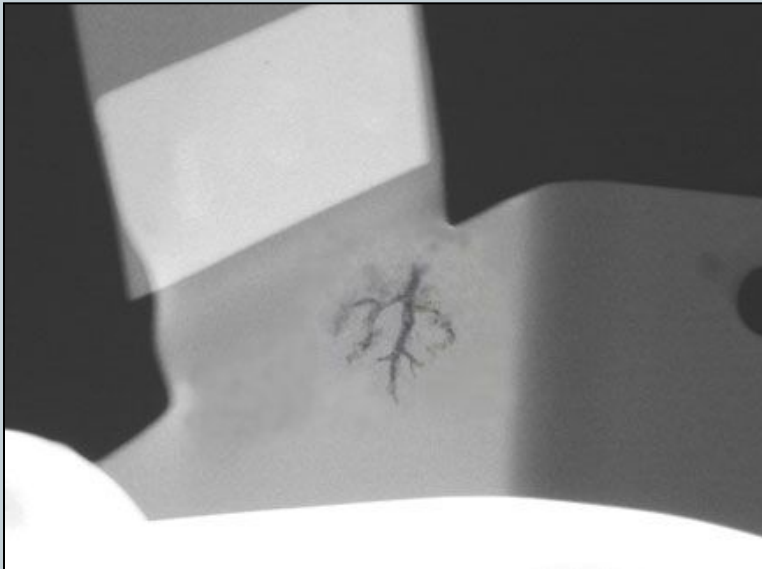

Casting Discontinuities

38

Slag and sand inclusions

Slag and sand inclusions – the entrapment of inclusion materials and sand cause these conditions, which will have irregular shapes and variations in density due to the nature of the included matter.

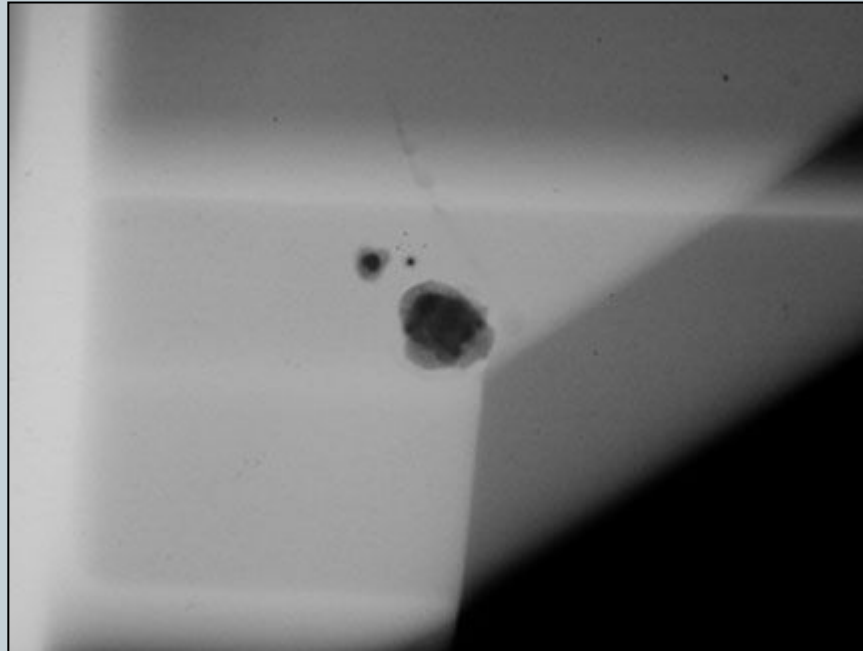

Casting Discontinuities

39

Gas voids and porosity

Gas voids and porosity – unlike the inclusions, gas voids and porosity are more uniform, typically globular and dark in appearance. In fact, these discontinuities just look like voids, are normally easy to detect (they are not subject to alignment limitations like cracks), and readily recognizable.

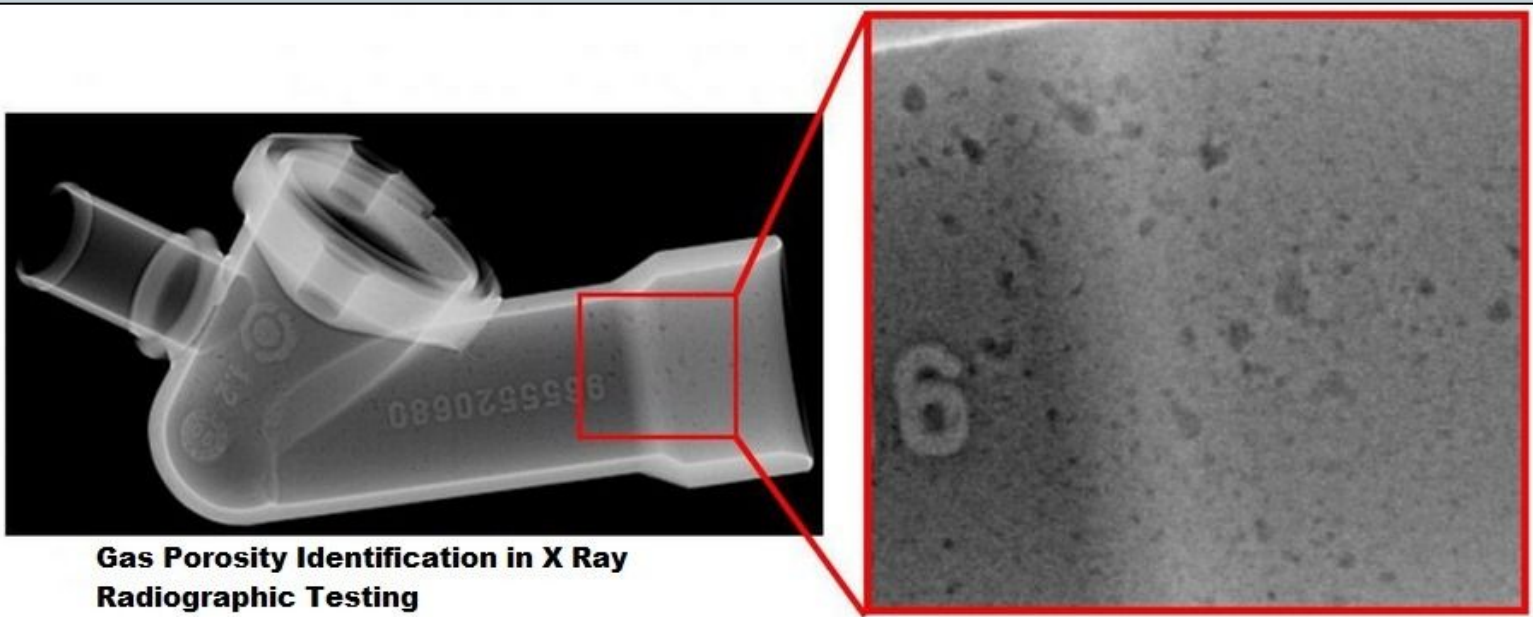

**Gas Porosity Identification in X Ray
Radiographic Testing**

Casting Discontinuities

40

Cold shuts

Cold shuts – very tight discontinuities that occur when a surface that has begun to solidify comes in contact with other molten metal as the casting is in the process of being poured. There is usually a thin film of oxide present that prevents total metallurgical fusion. It is a very difficult discontinuity to detect with radiography

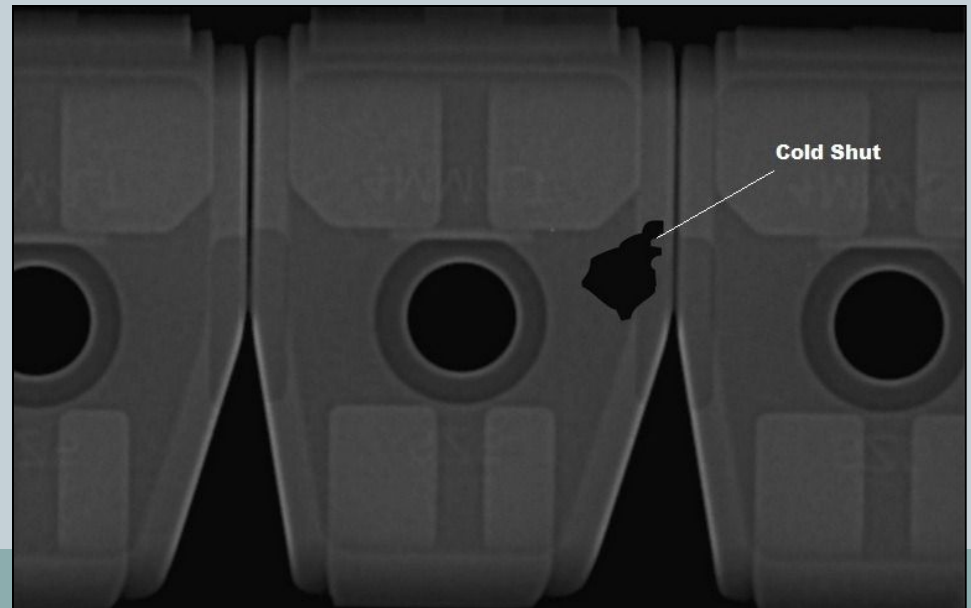
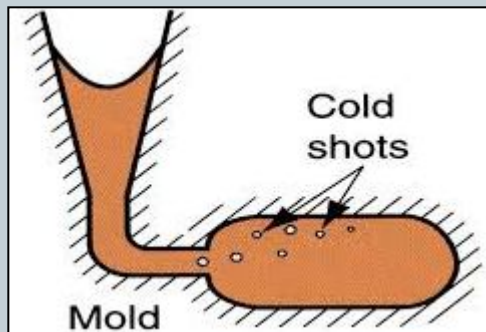

Geometric Conditions

41

There are also geometric conditions in castings that can be observed radiographically.

These geometric conditions include the following: misrun, unfused chaplets.

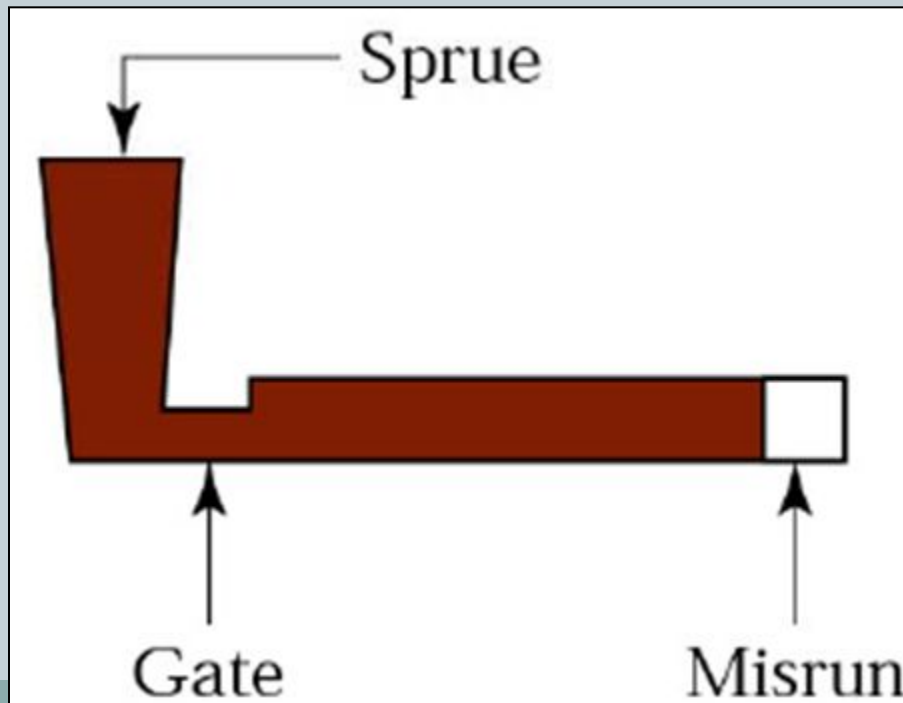

Misrun – this condition is actually an absence of metal due to the inadequate filling of the casting mold. It is easily detected by a simple visual test.

Applications

42

Although the majority of applications in radiographic testing appear to involve welds and castings, it has been effectively applied to many other product forms spanning a wide variety of industries. The major industries include following.

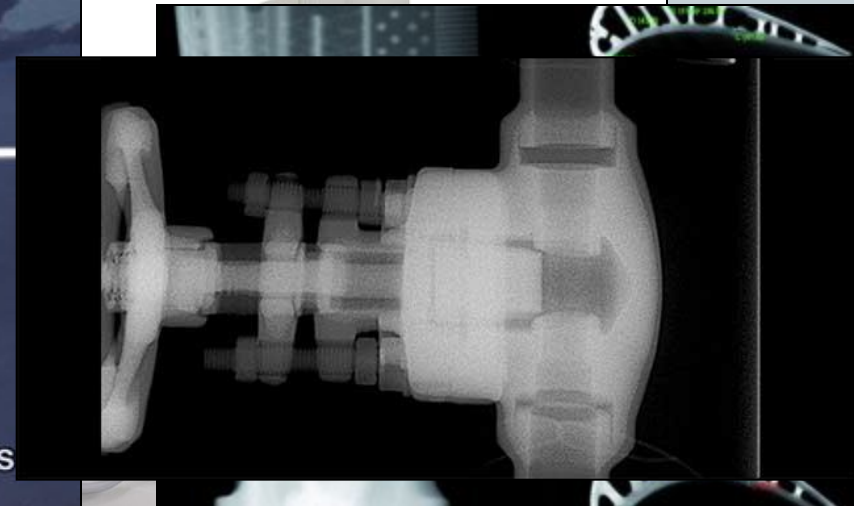
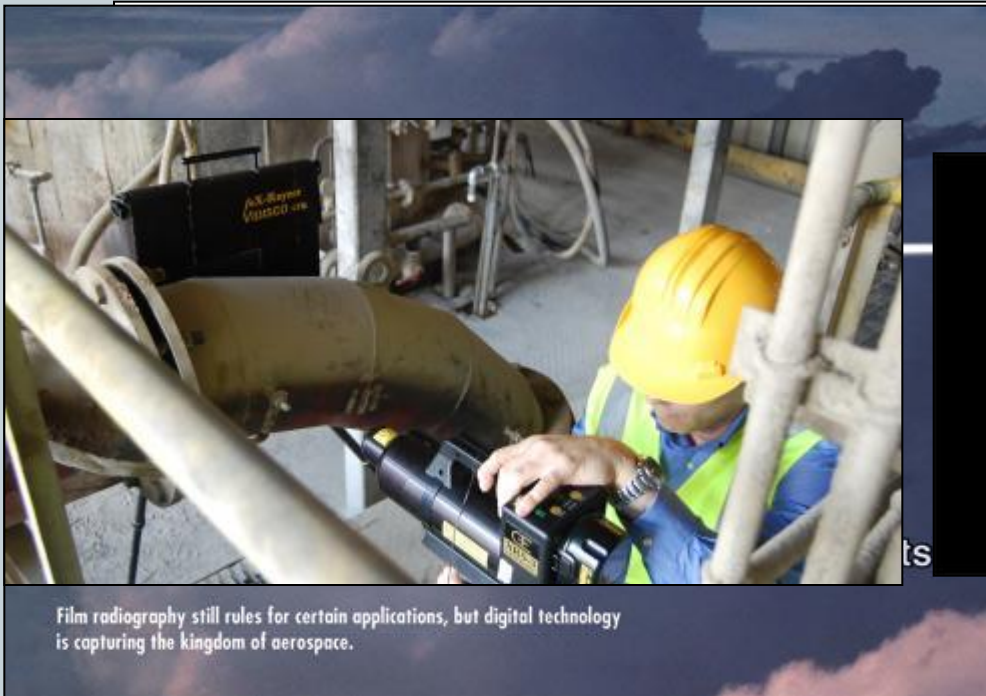

Advantages of Radiography

43

- Provides an extremely accurate and permanent record
- Is very versatile and can be used to examine many shapes and sizes
- Is quite sensitive, assuming the discontinuity causes a reasonable reduction of cross section thickness
- Permits discontinuity characterization
- Is widely used and time-proven
- Is a volumetric NDT method

Limitations

44

1. There are safety hazards with the use of radiation devices
2. RT has thickness limitations, based on material density and energy used
3. RT can be time-consuming
4. RT is very costly in initial equipment and expendable materials
5. It is also very dependent on discontinuity orientation
6. RT requires extensive experience and training of the personnel taking the radiographs and during the interpretation

Thank you for attention