

La pronunciación

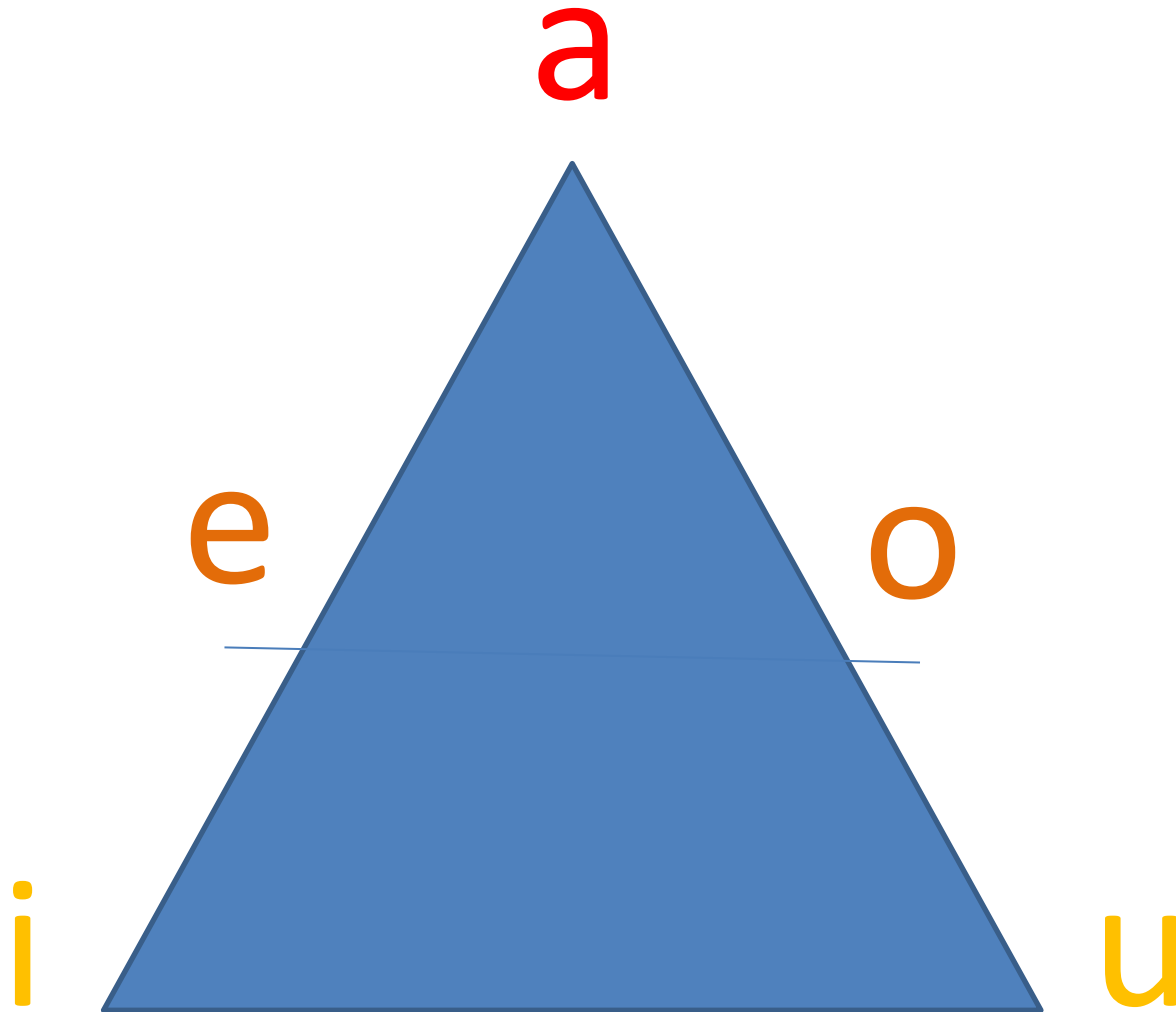

Vocales: a e i o u

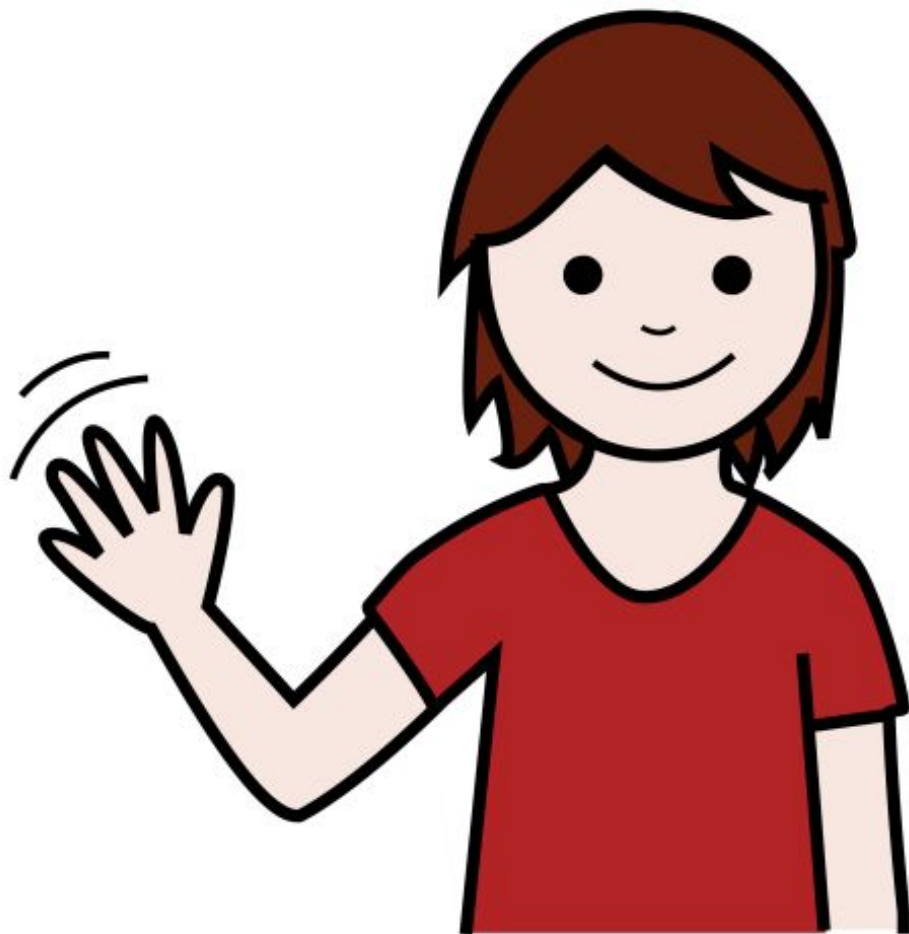



hola

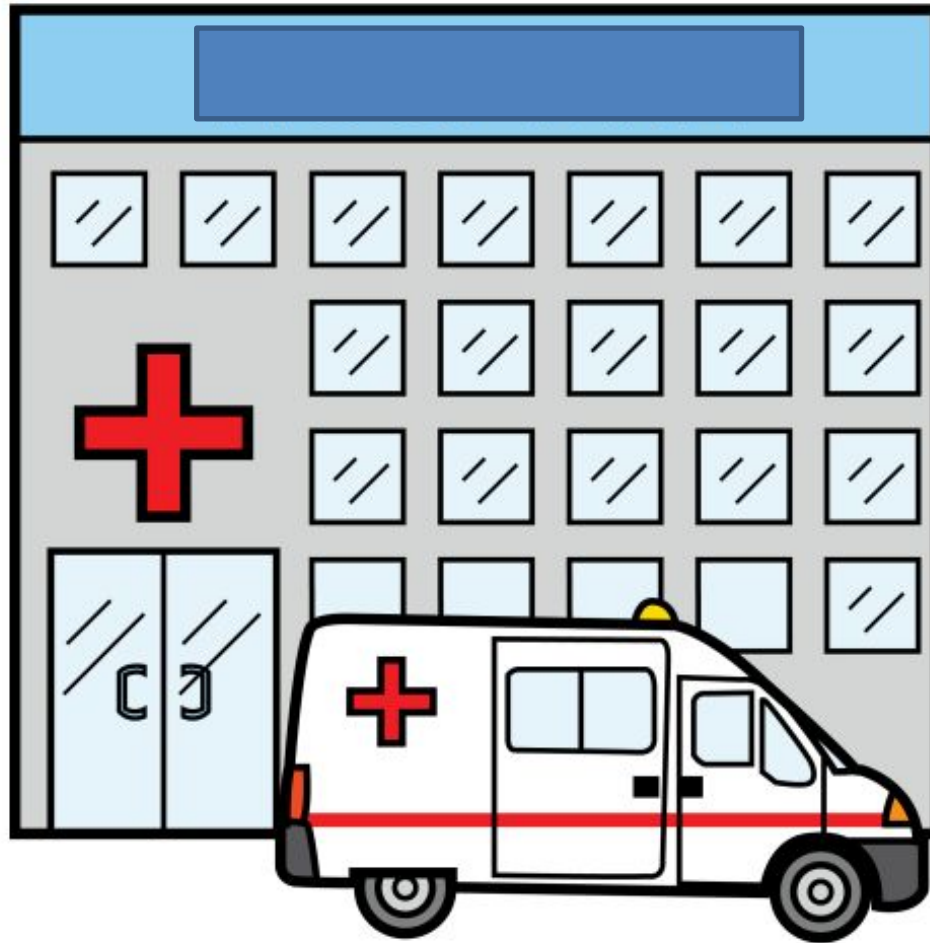

hospital



hotel

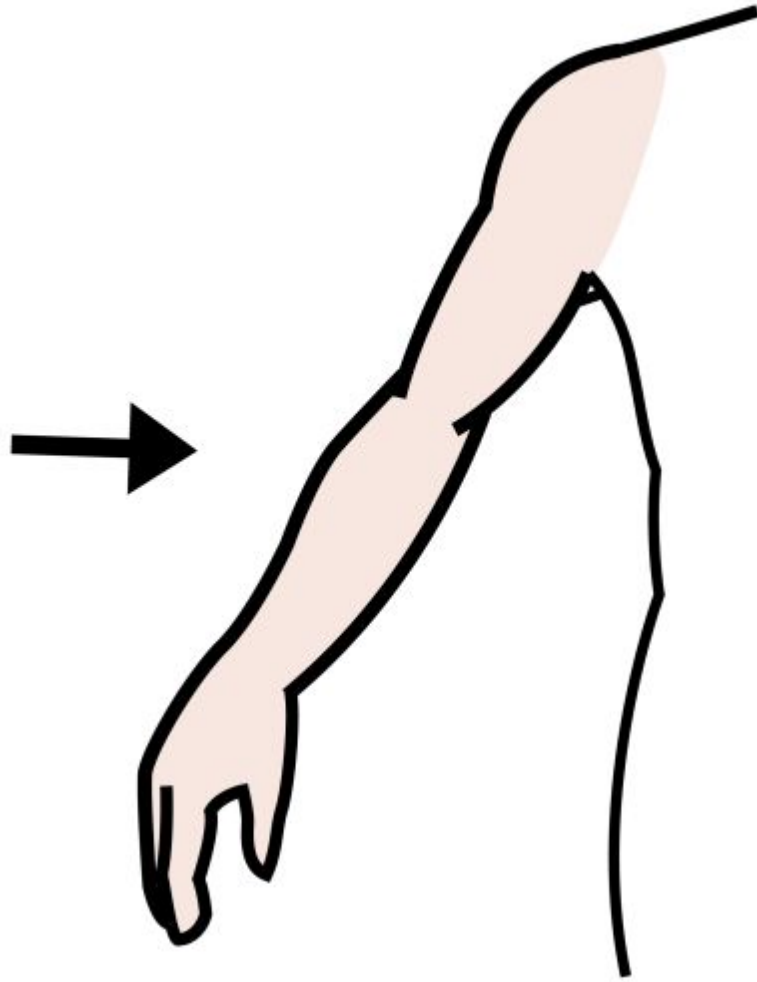

рука



Музыка

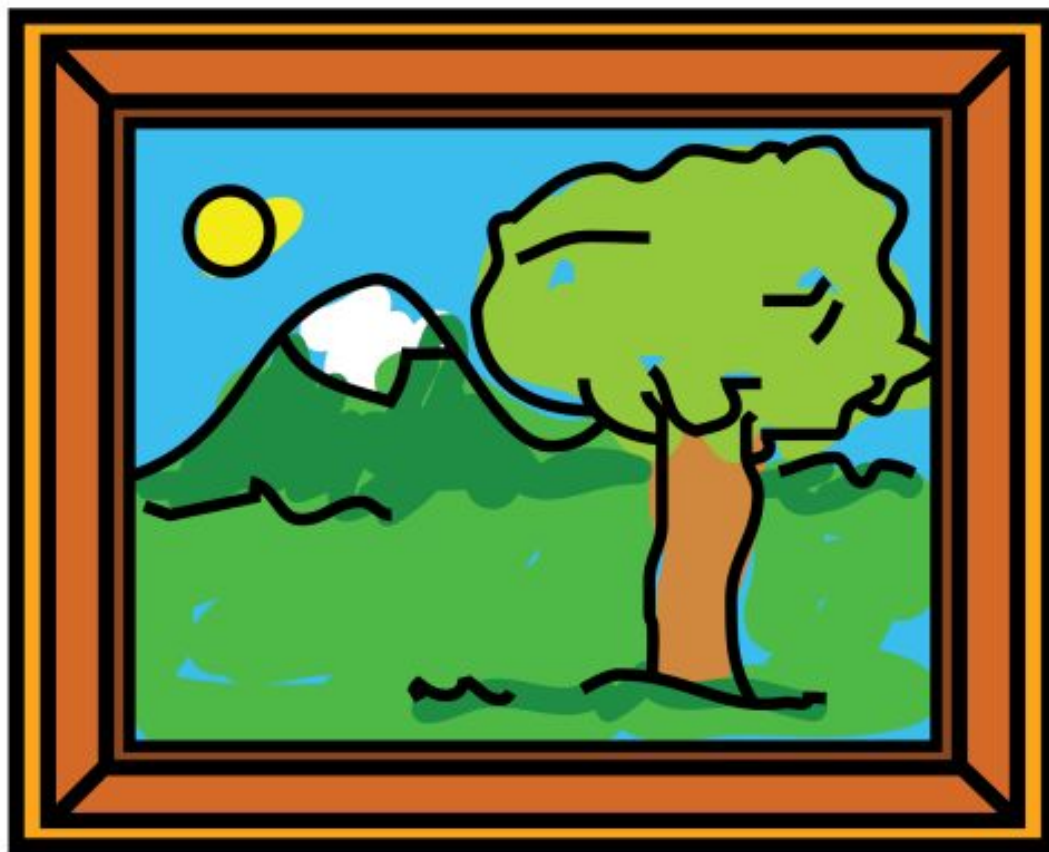

сартина

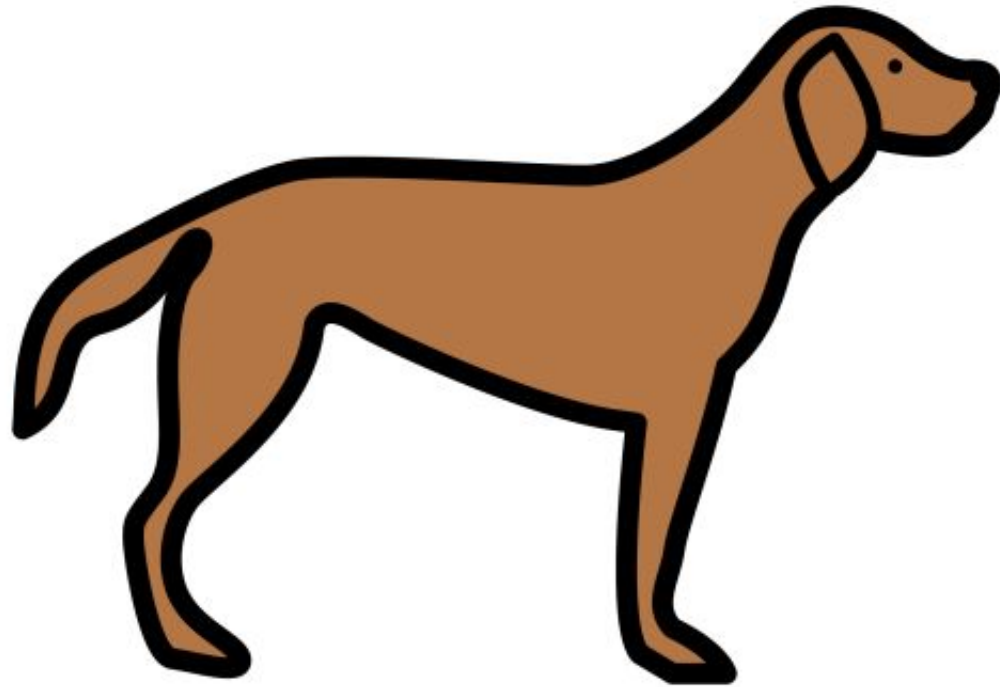

собака



peca



café



cámara



música



casino



informática



паquet



букет



Супермаркет

T



Океан

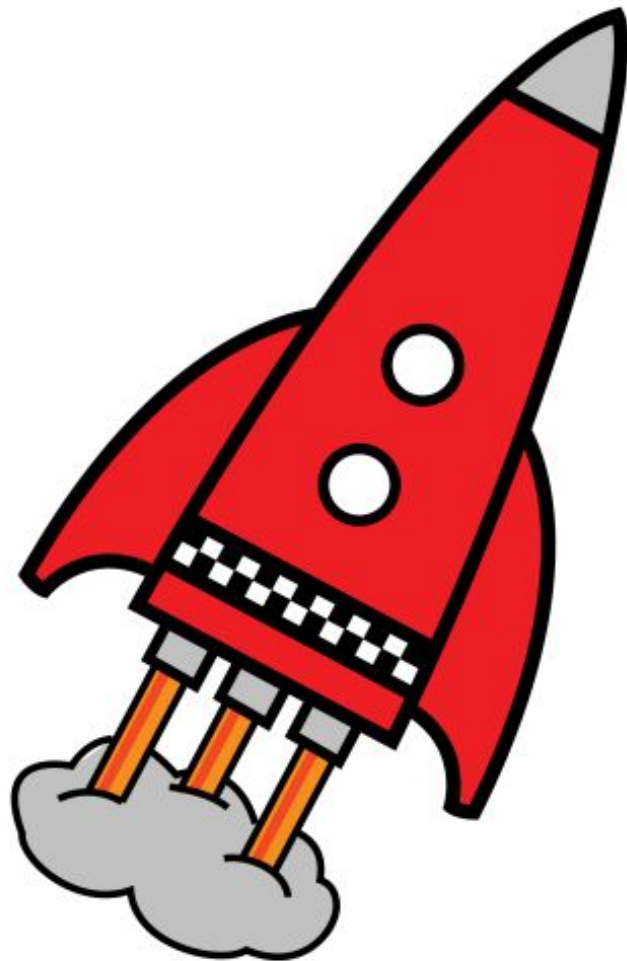

ракет

а



parque



orquesta

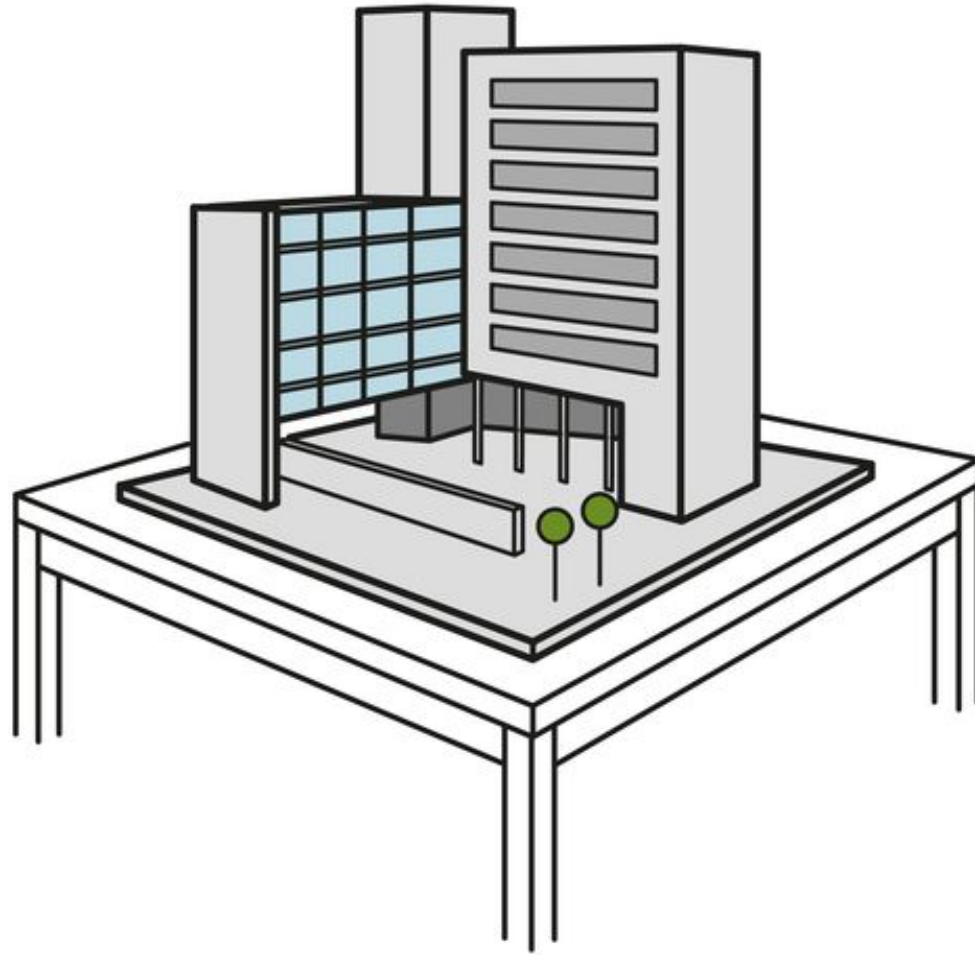

maqueta



esqueleto

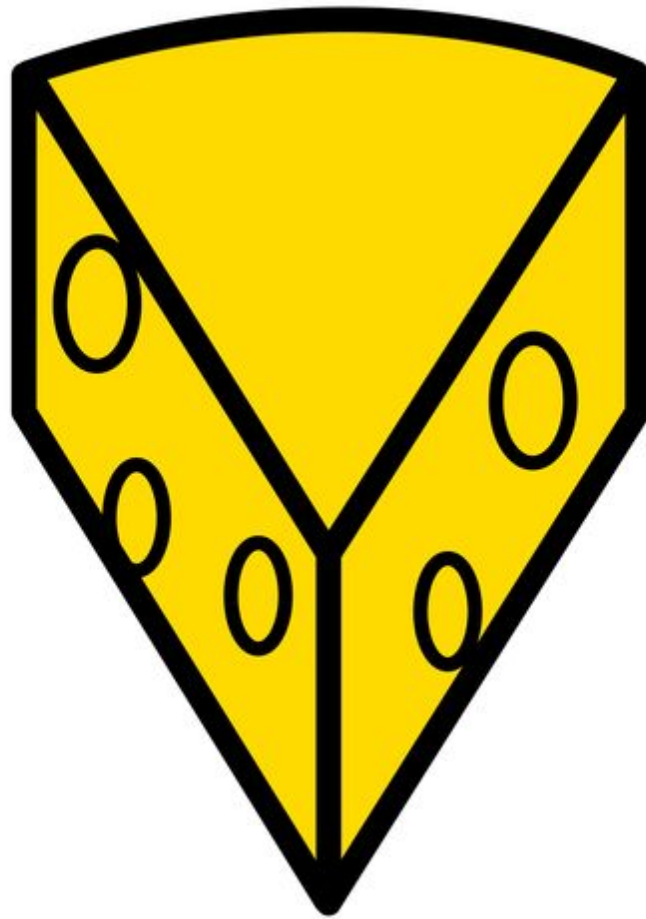

queso



quino

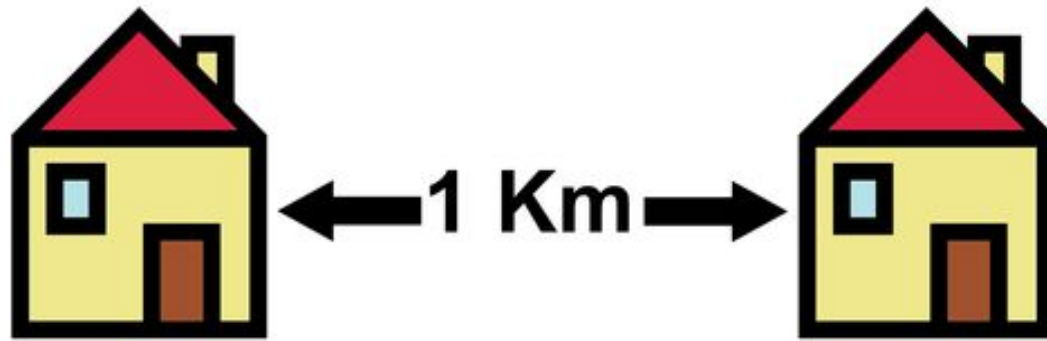

кілометр



Виски

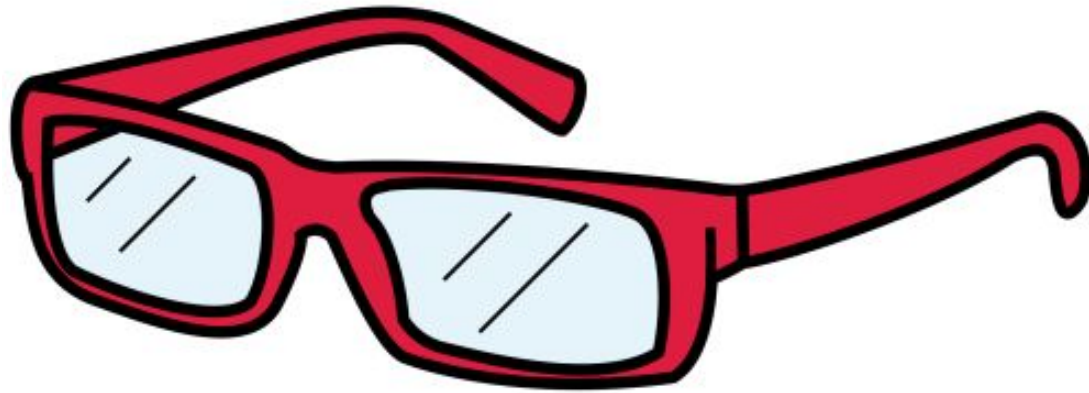

очқи



русский



arquitecto



quiosco



biquini

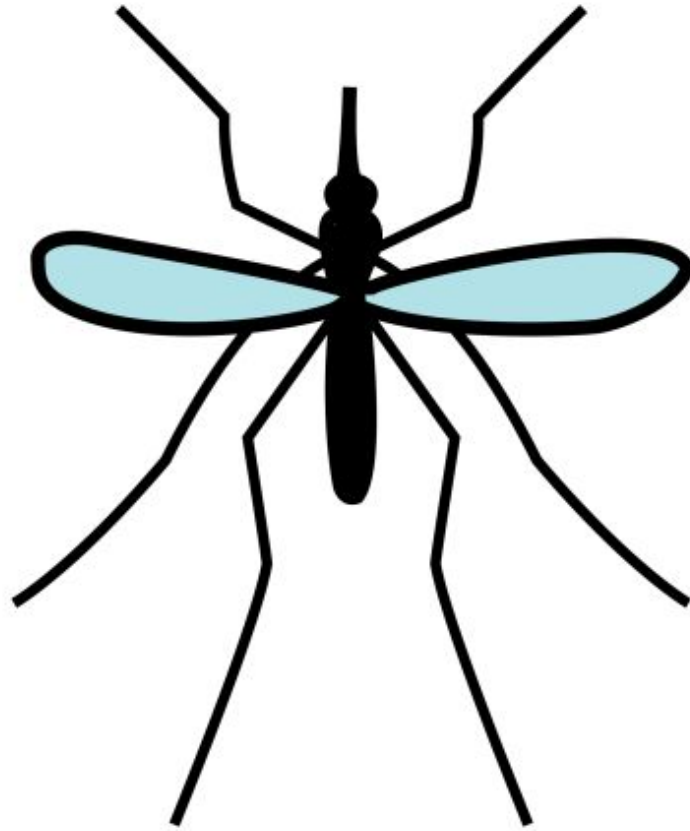

mosquito

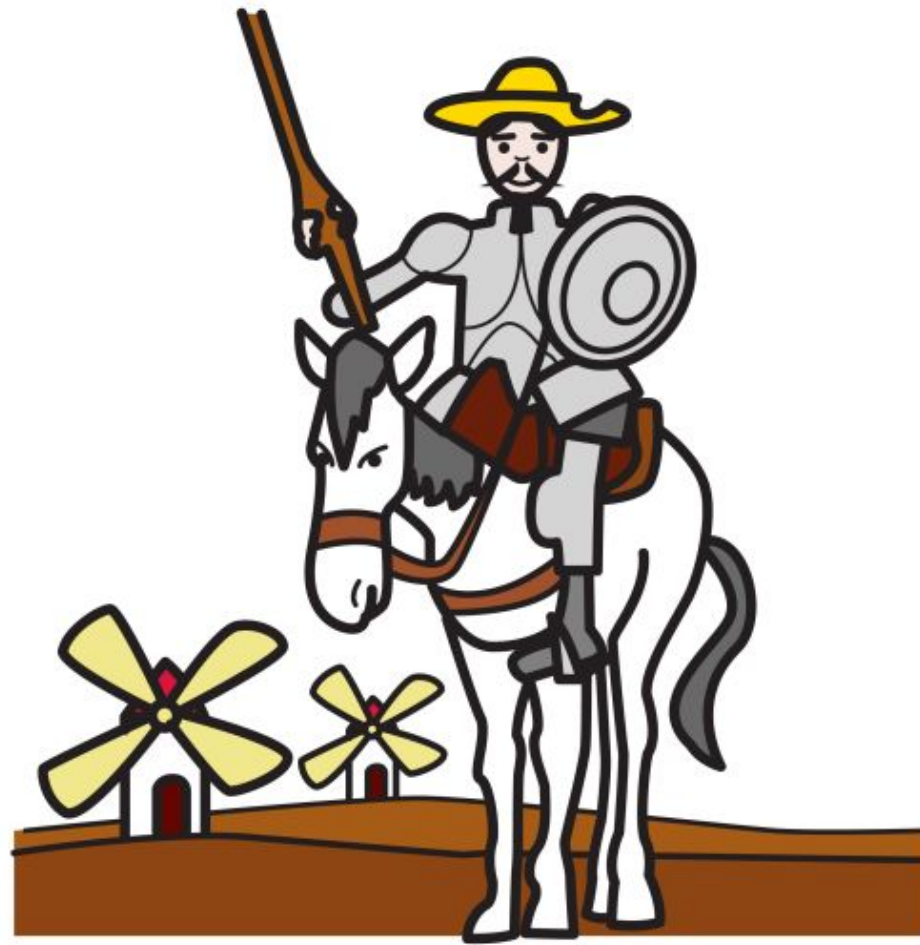

Don Quijote



сомната



Школа

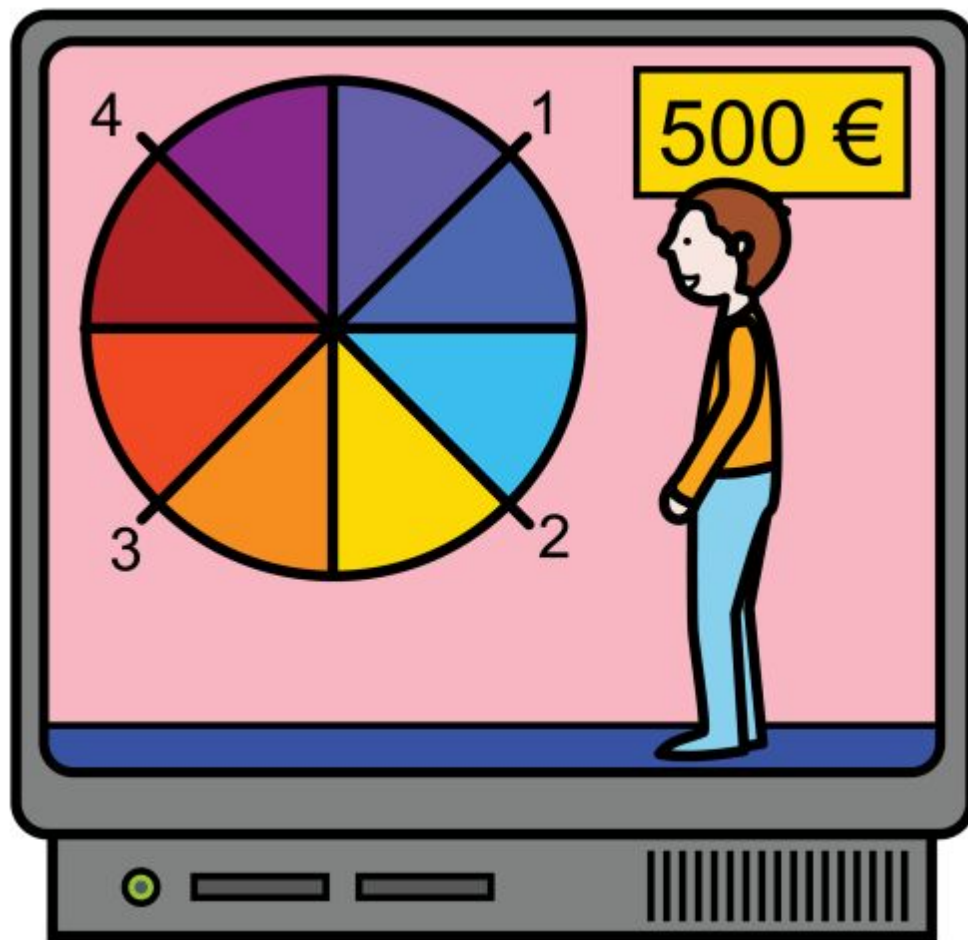

сонкурс

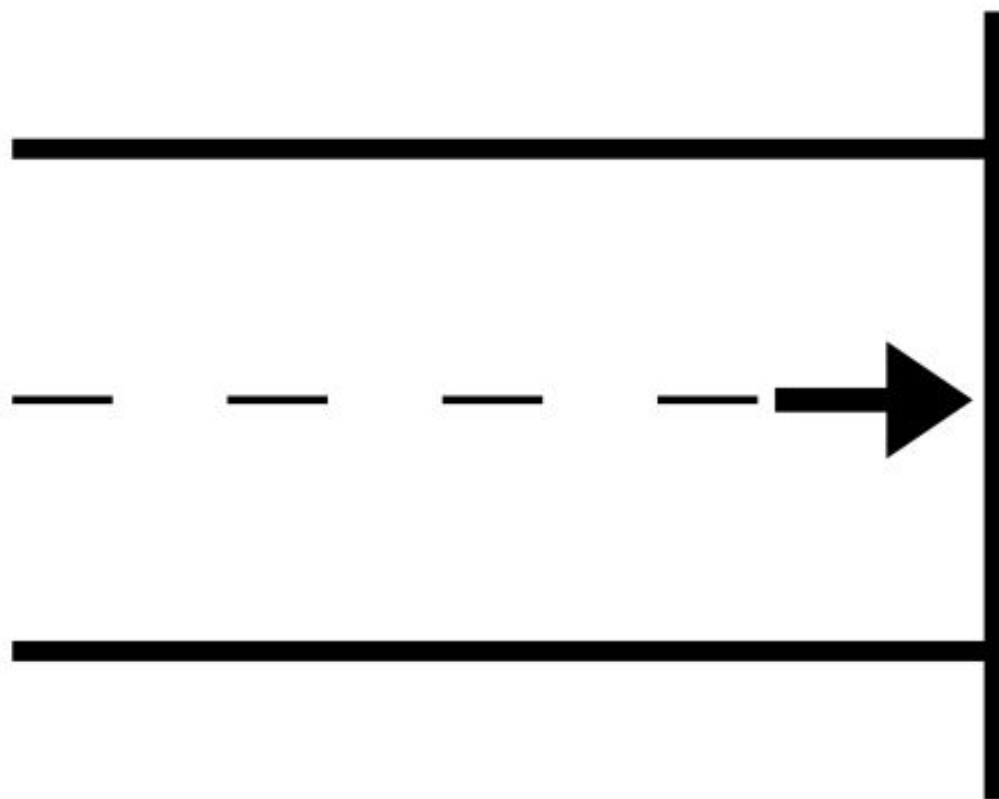

сонеч



banco

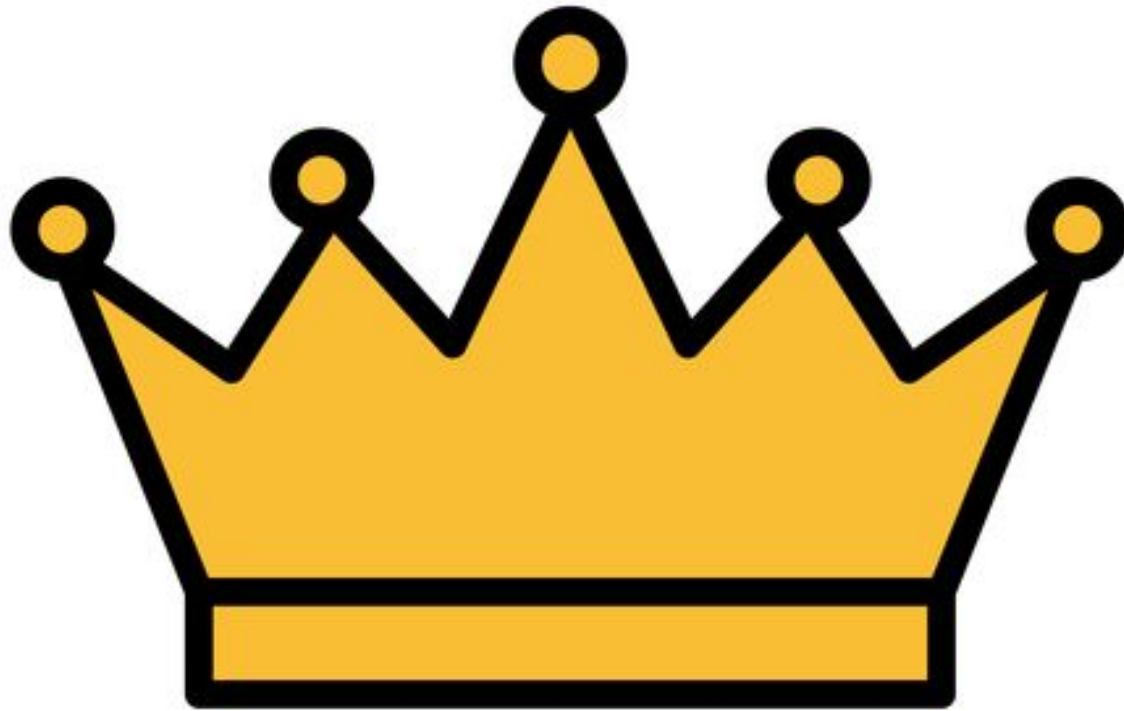

corona



cómoda

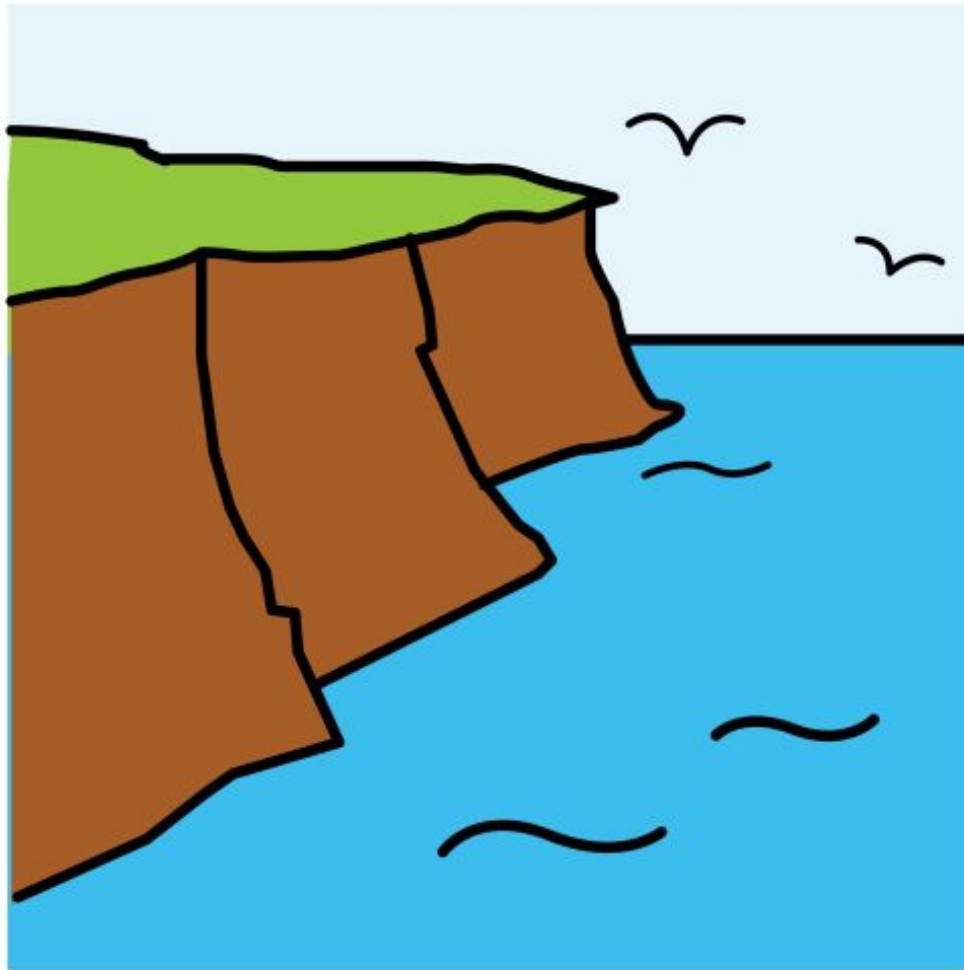

costa

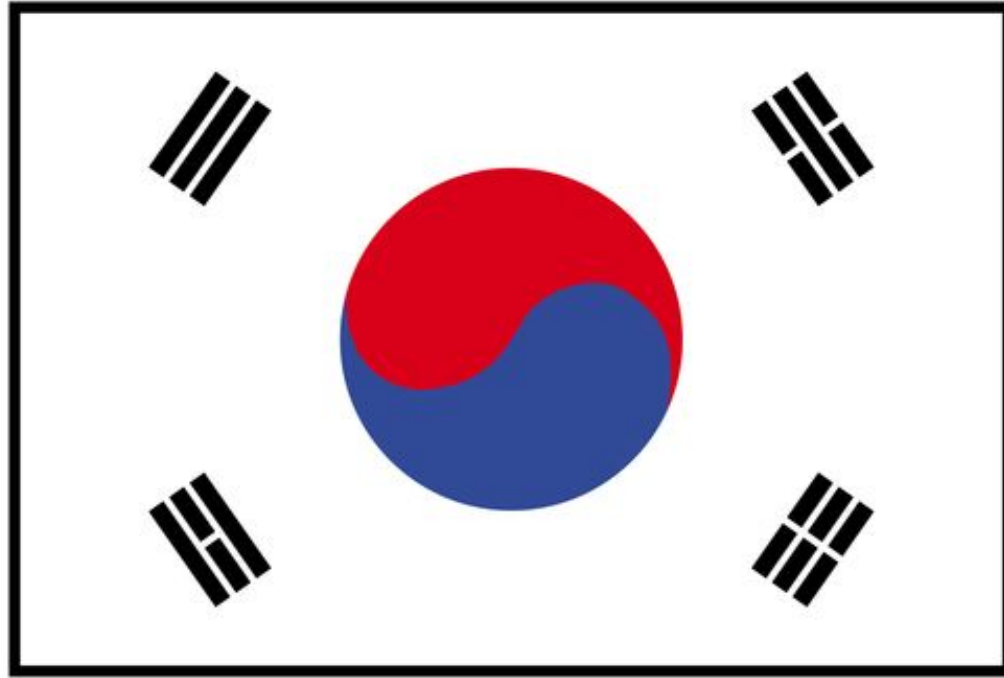

Corea del Sur

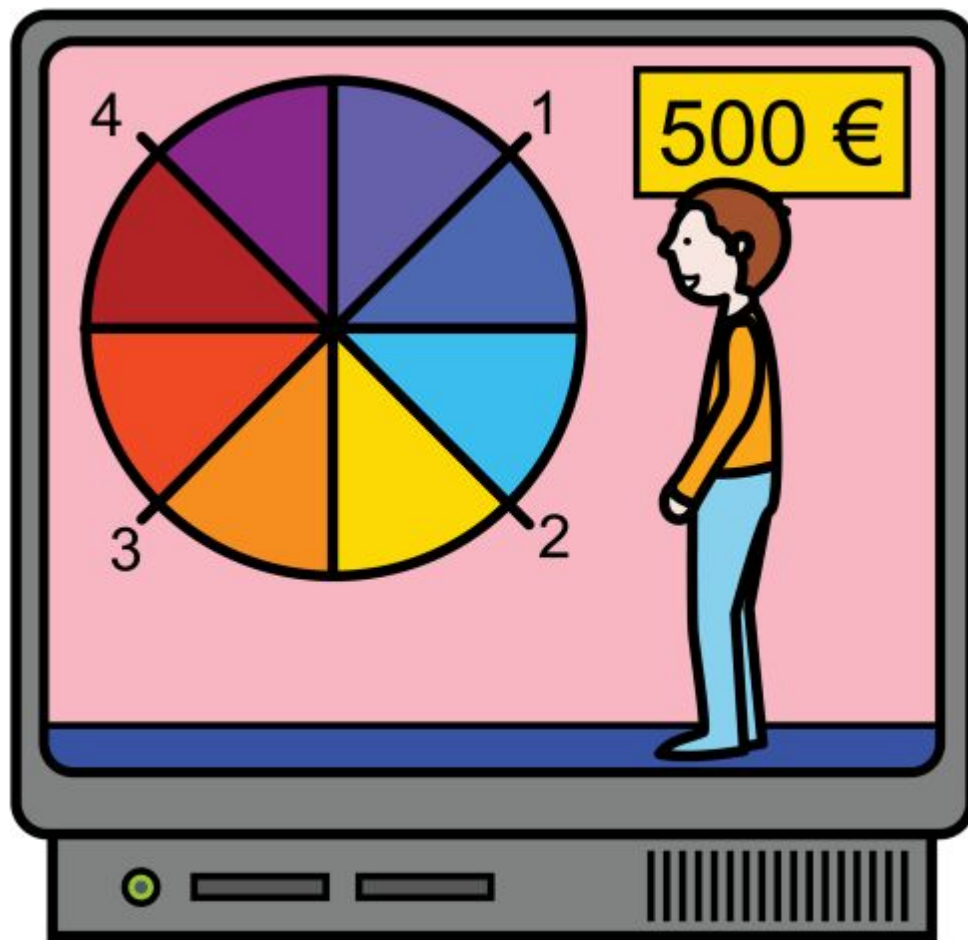

конкурс

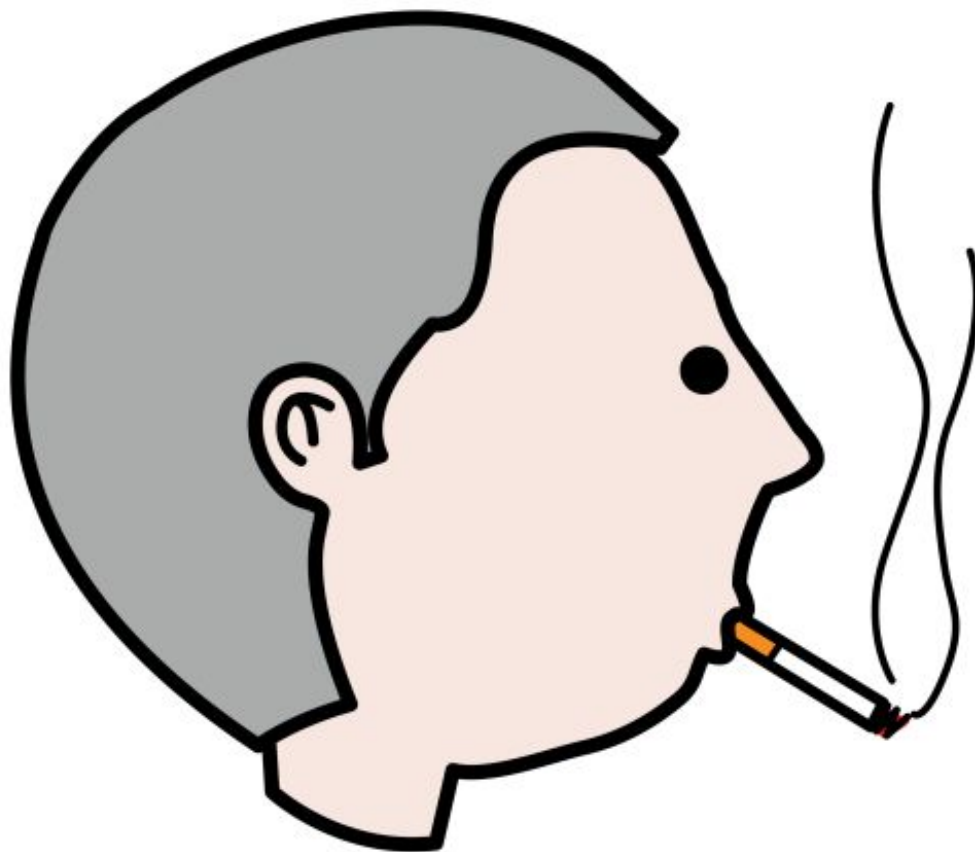

сирить



посипать



сиртка

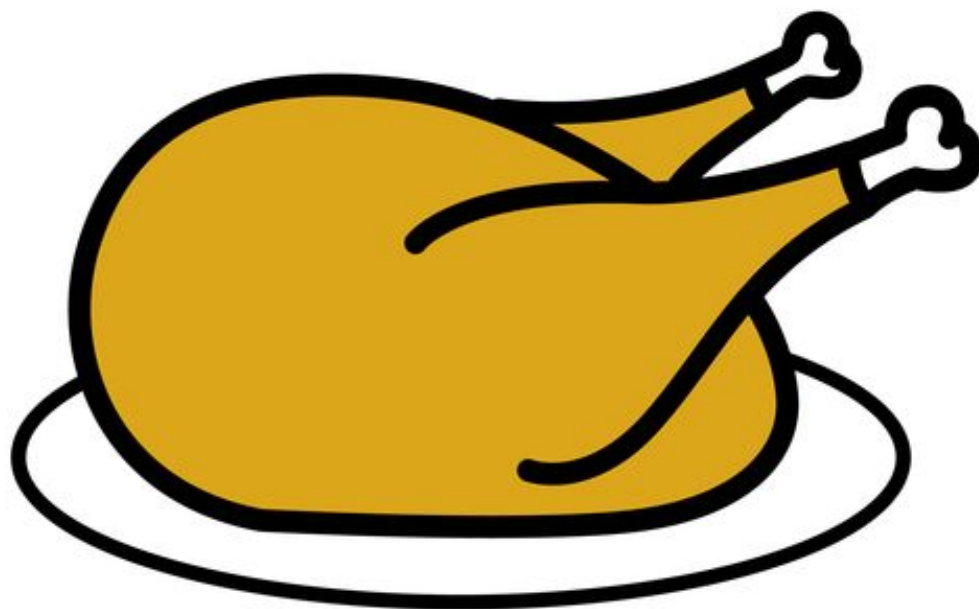

сирица

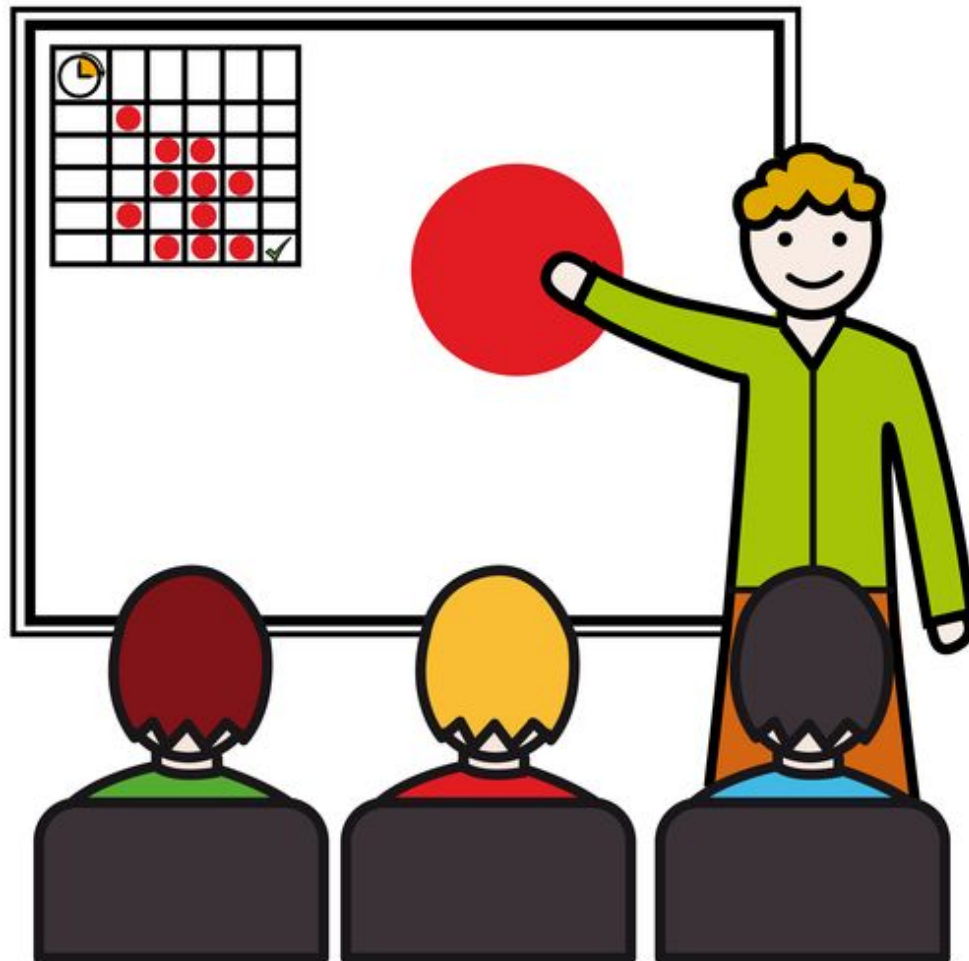

curso

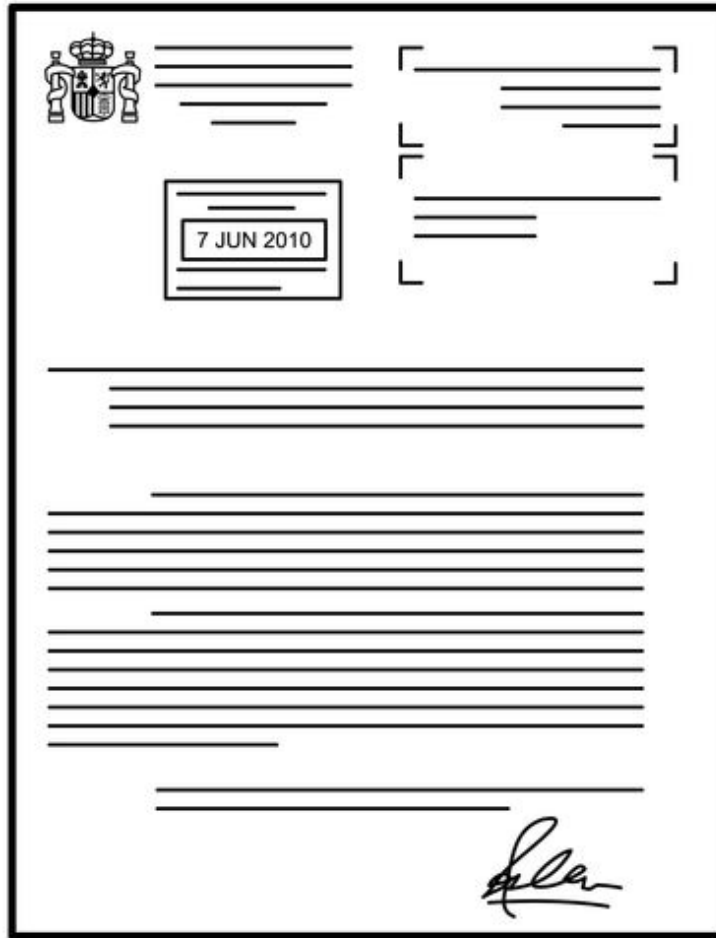

documento



Cuba



escuela

4

cuatro

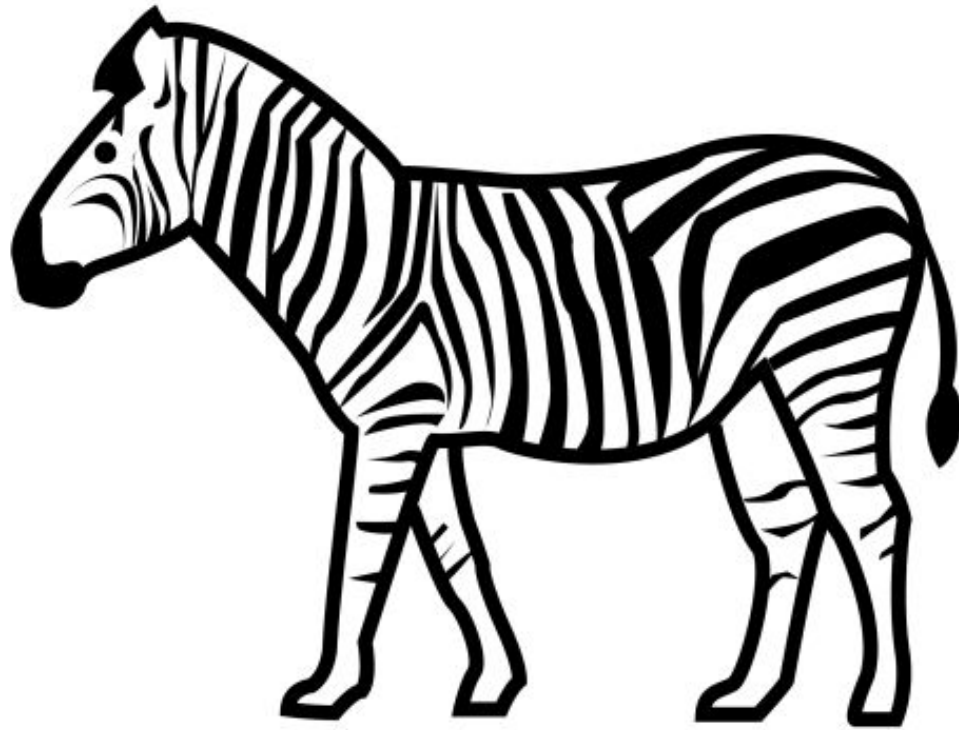

cebra

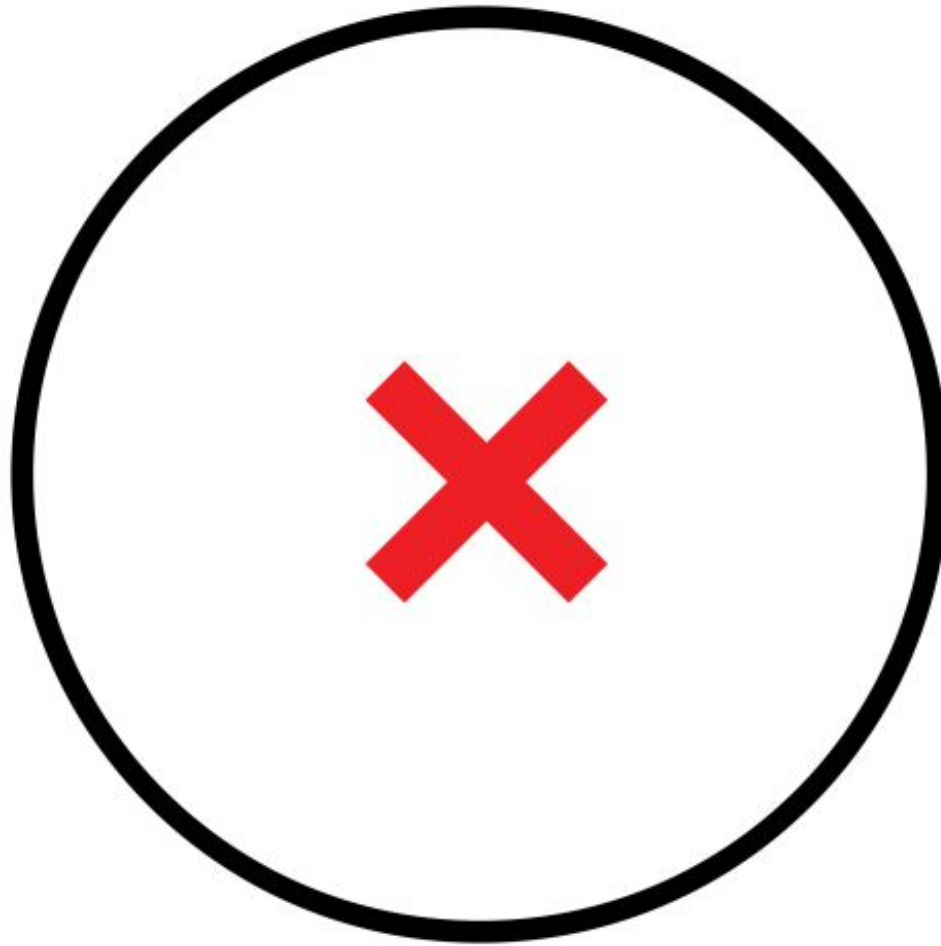

centro

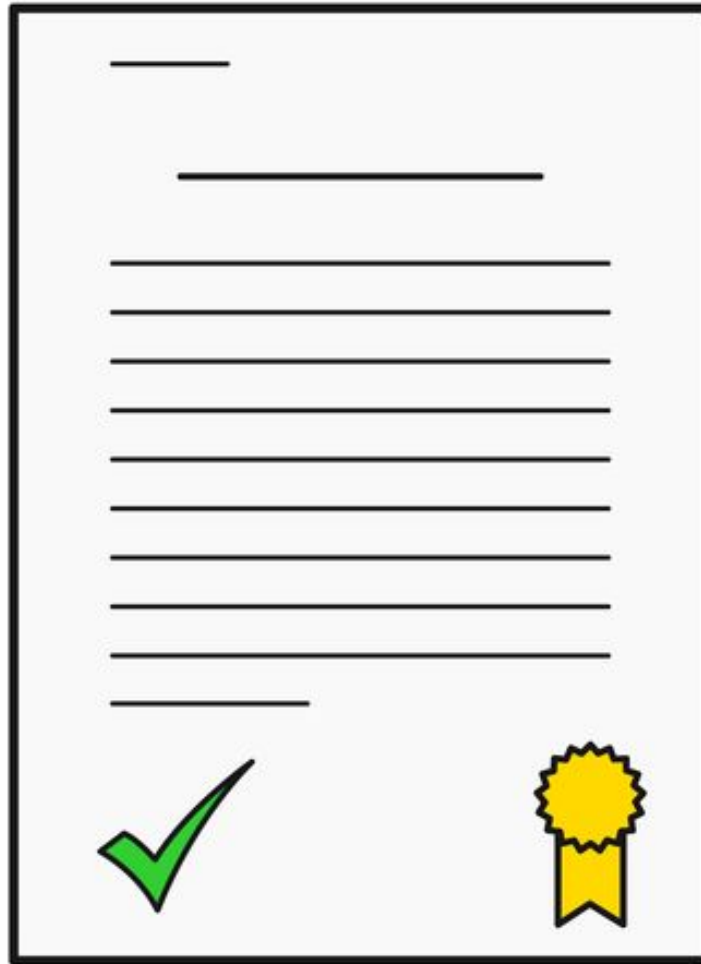

certificado



baloncesto



Cervantes



cine



oficina

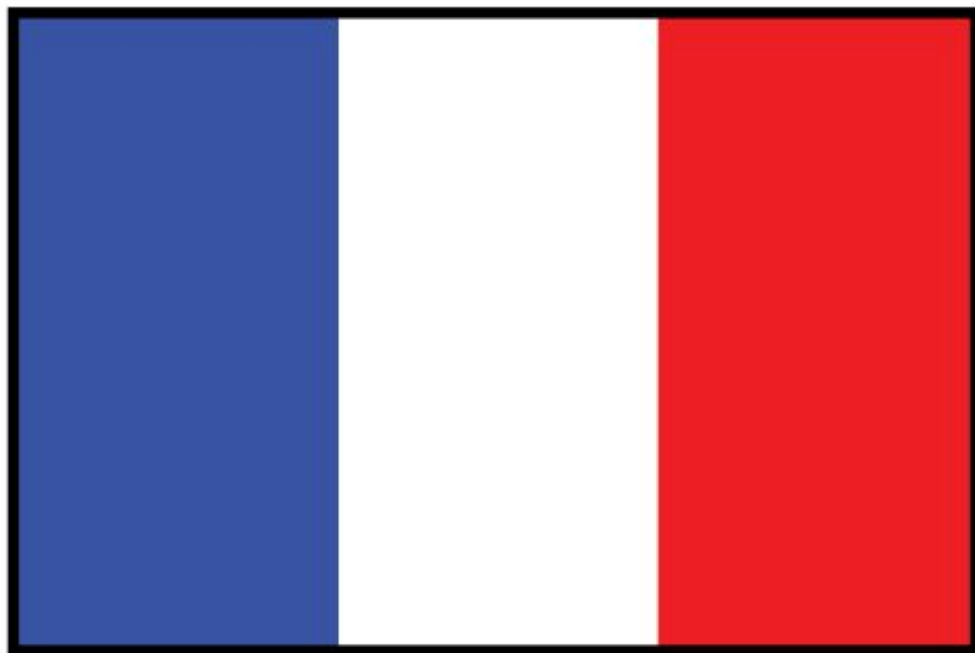

Francia



policía

5

cinco

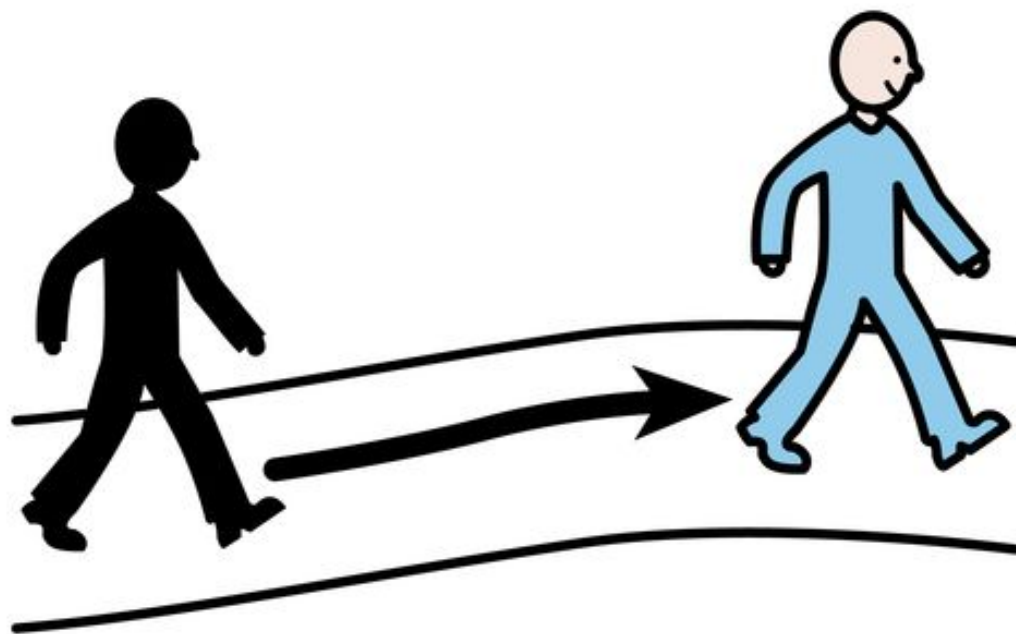

ДВИГАТЬСЯ



бегаТЬ



богатый

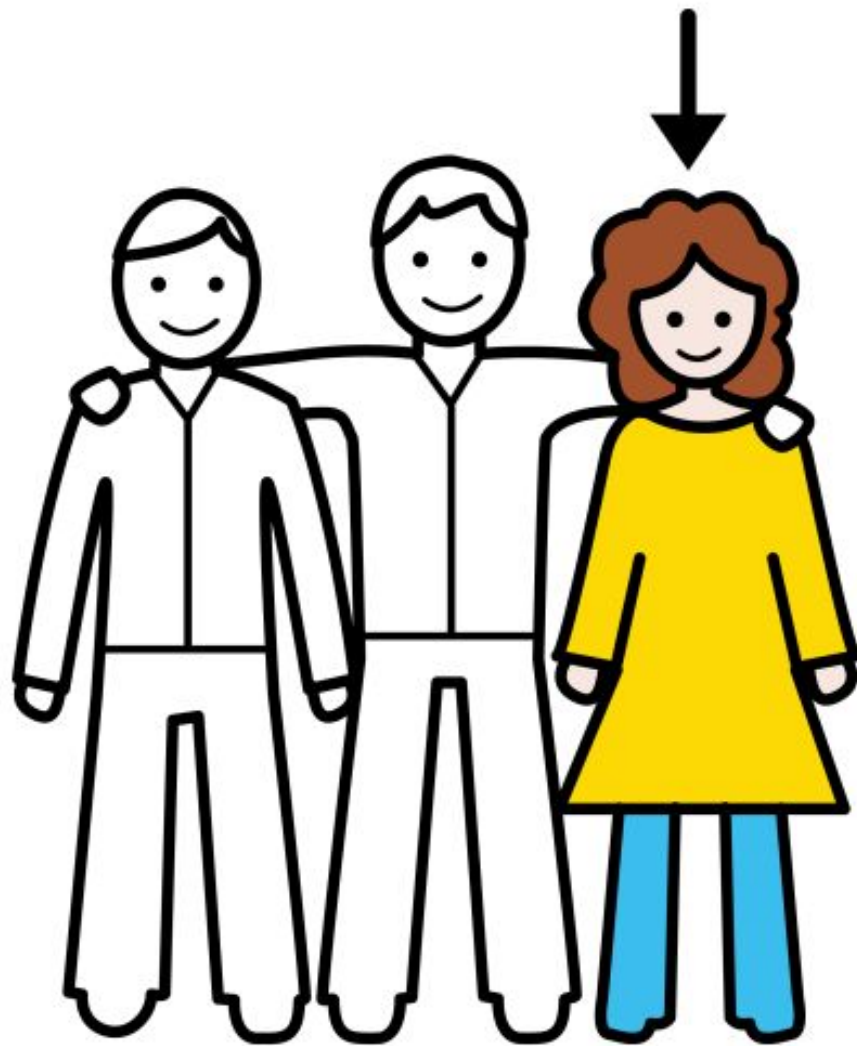

подруга

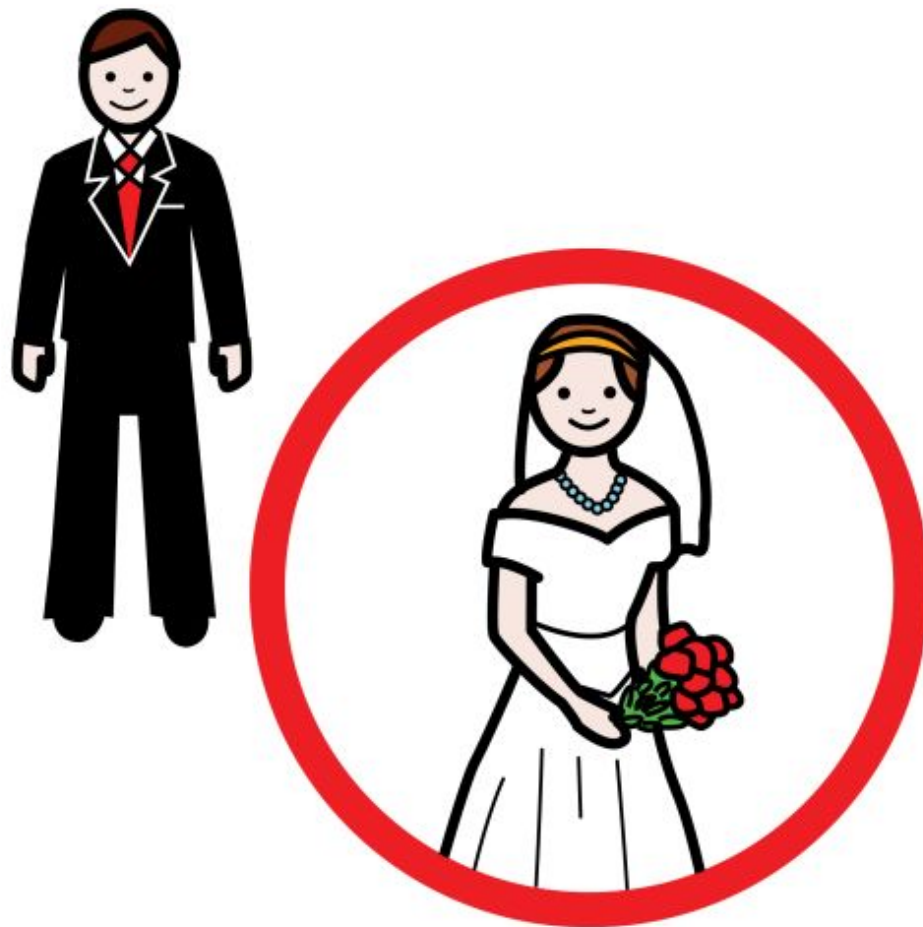

супруга

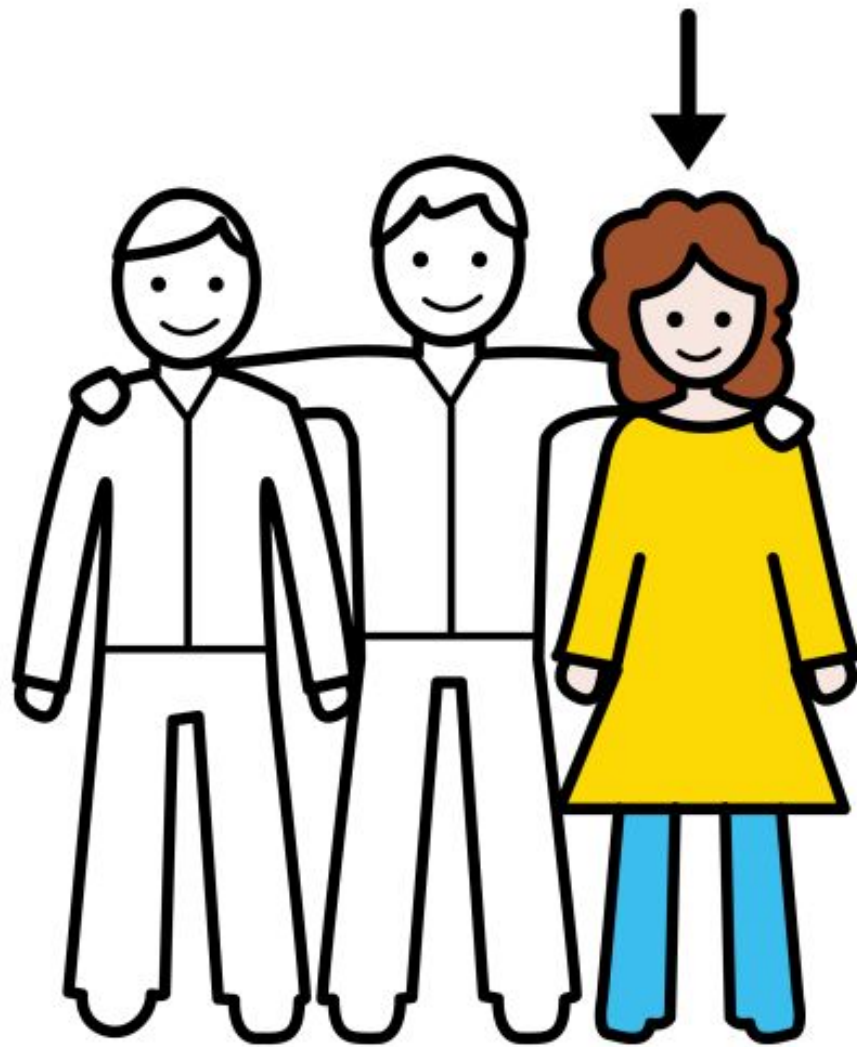

amiga



yoga

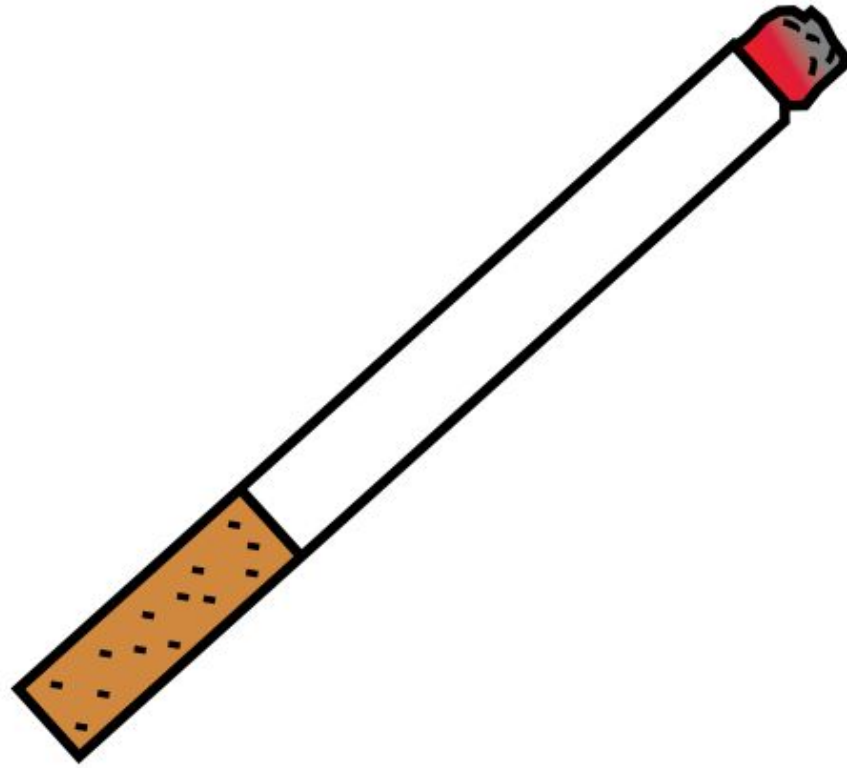

cigarro

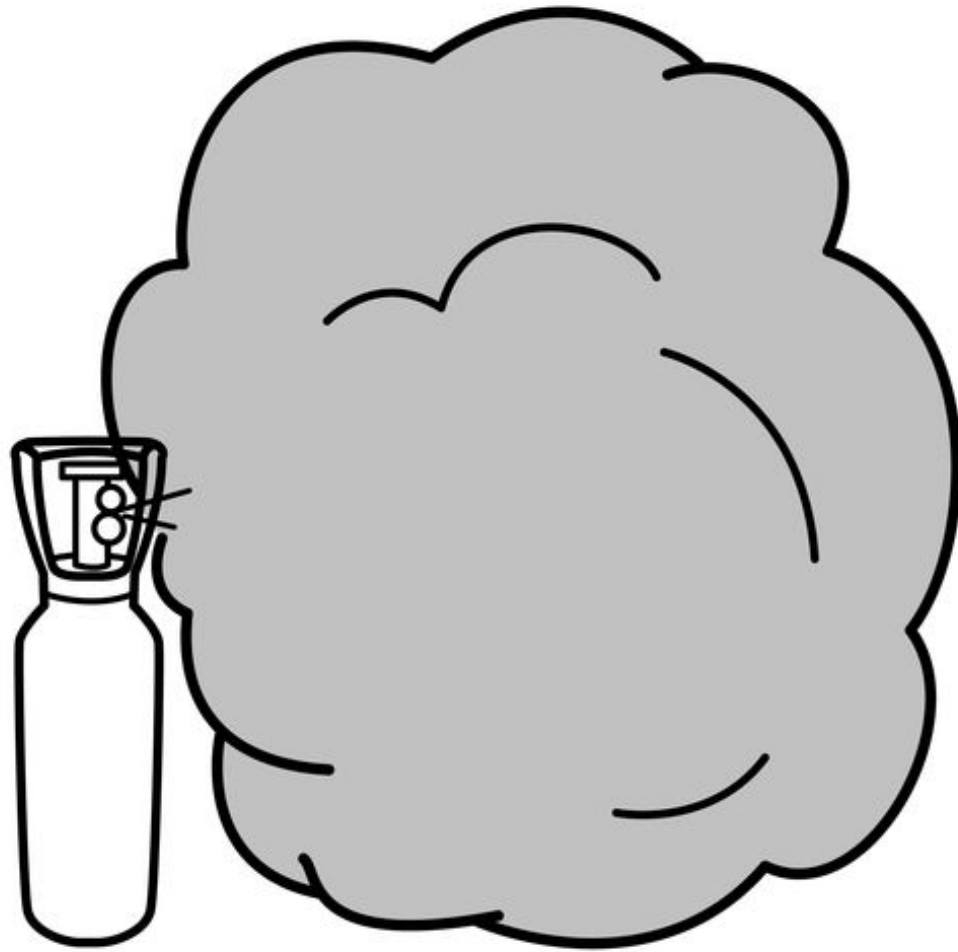

gas

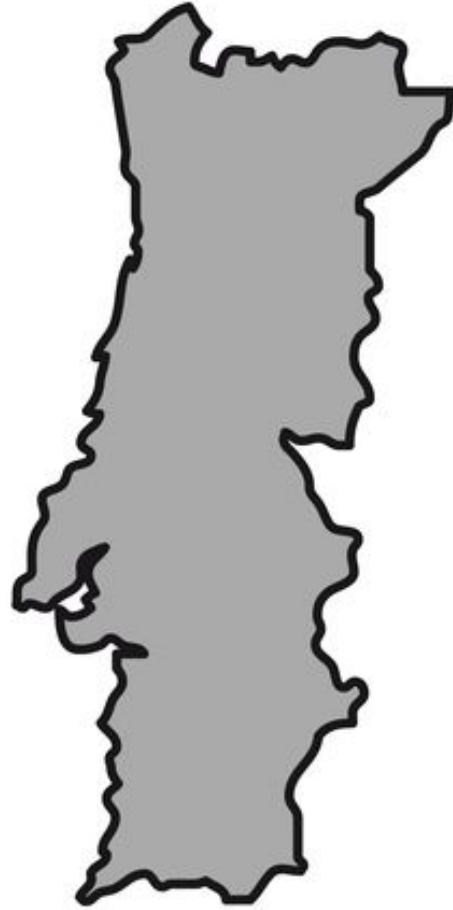

Portugal

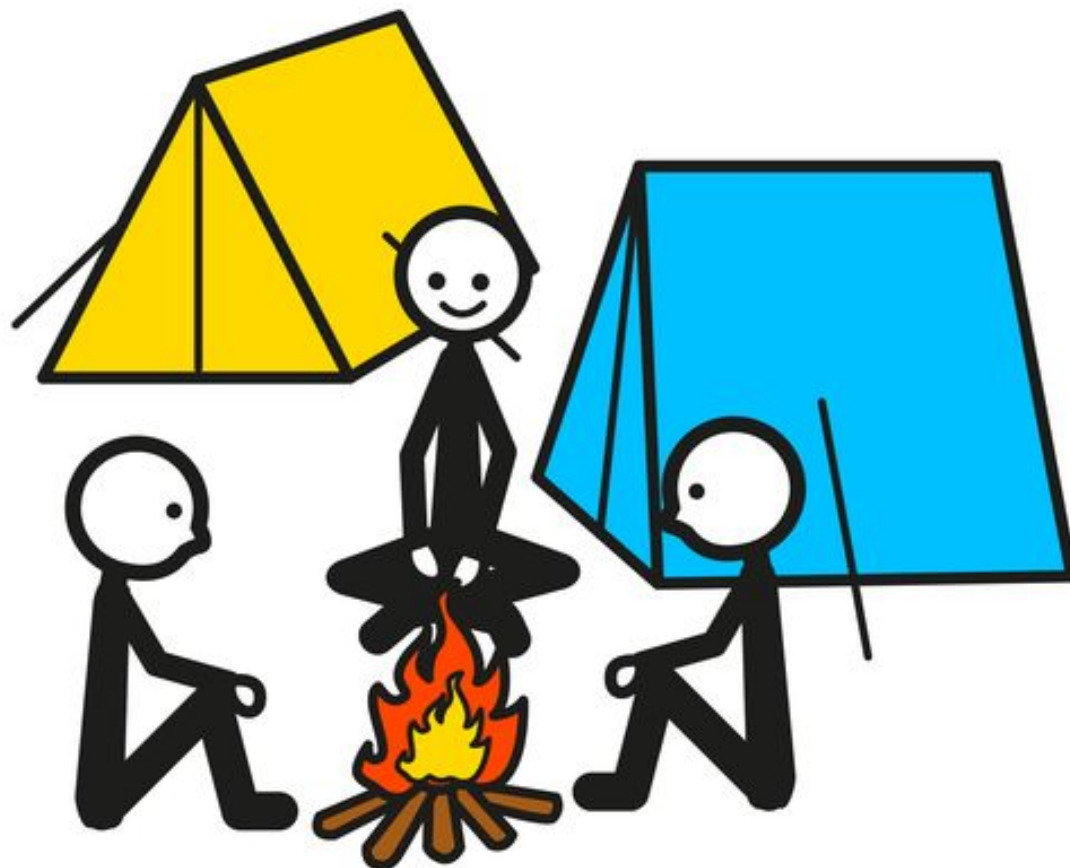

лагерь



ангел

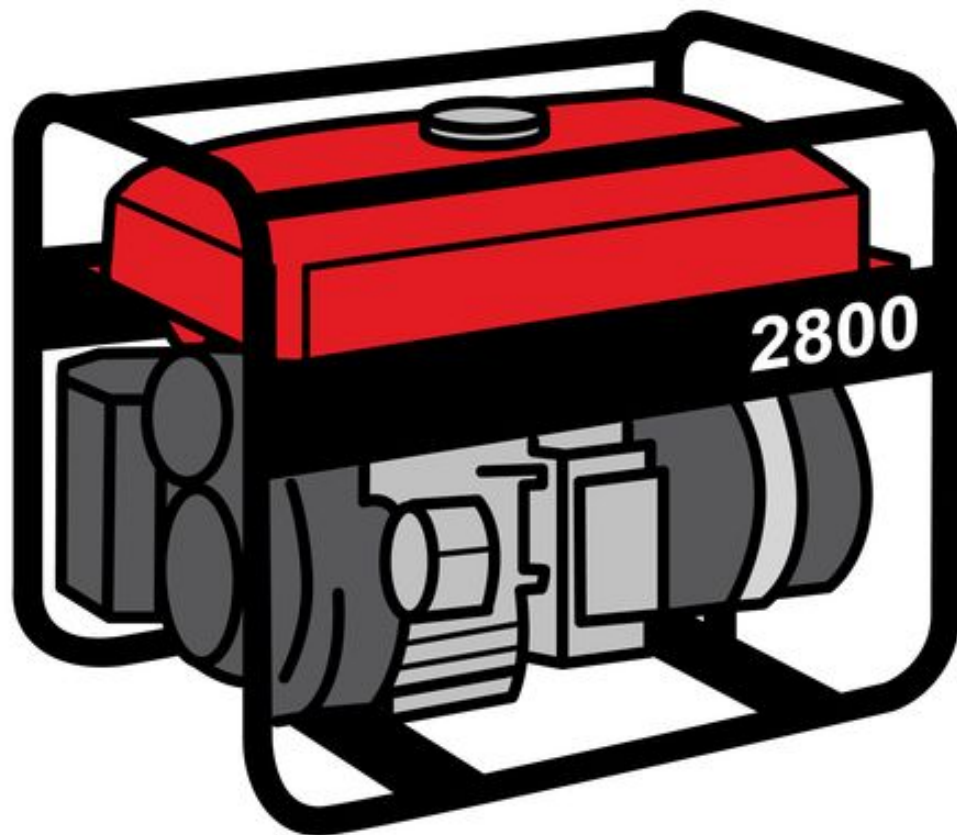

генератор



гүерб

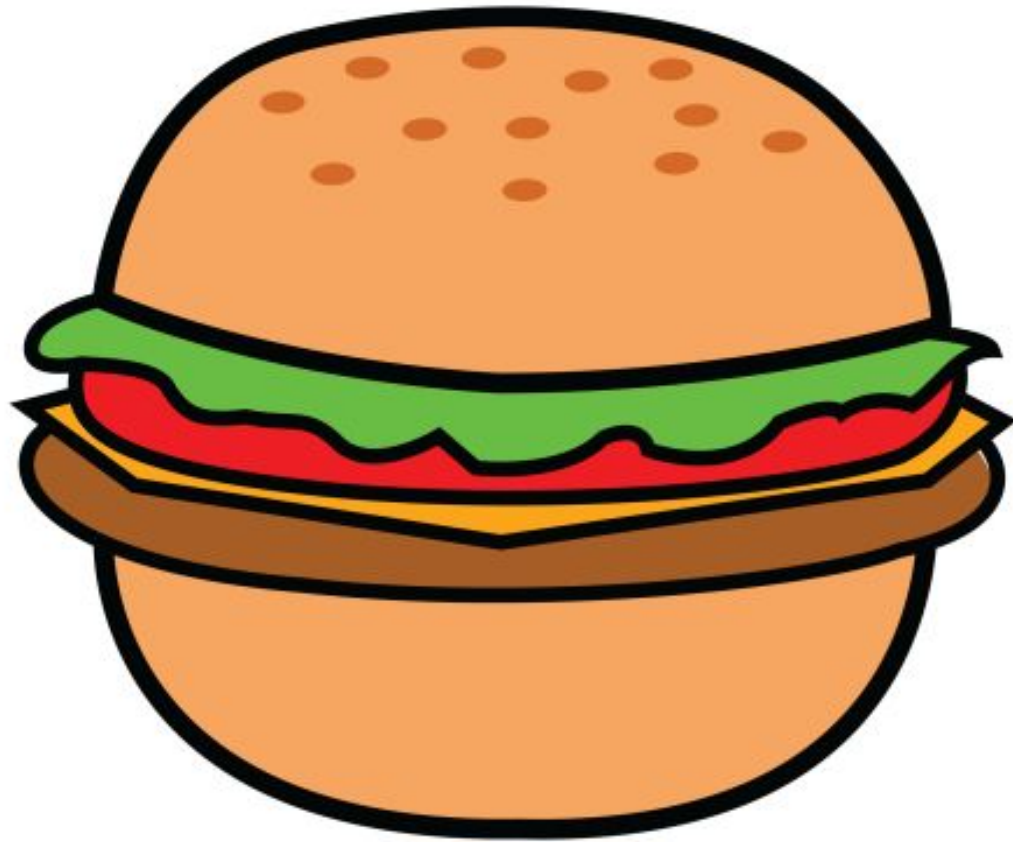

hamburguesa

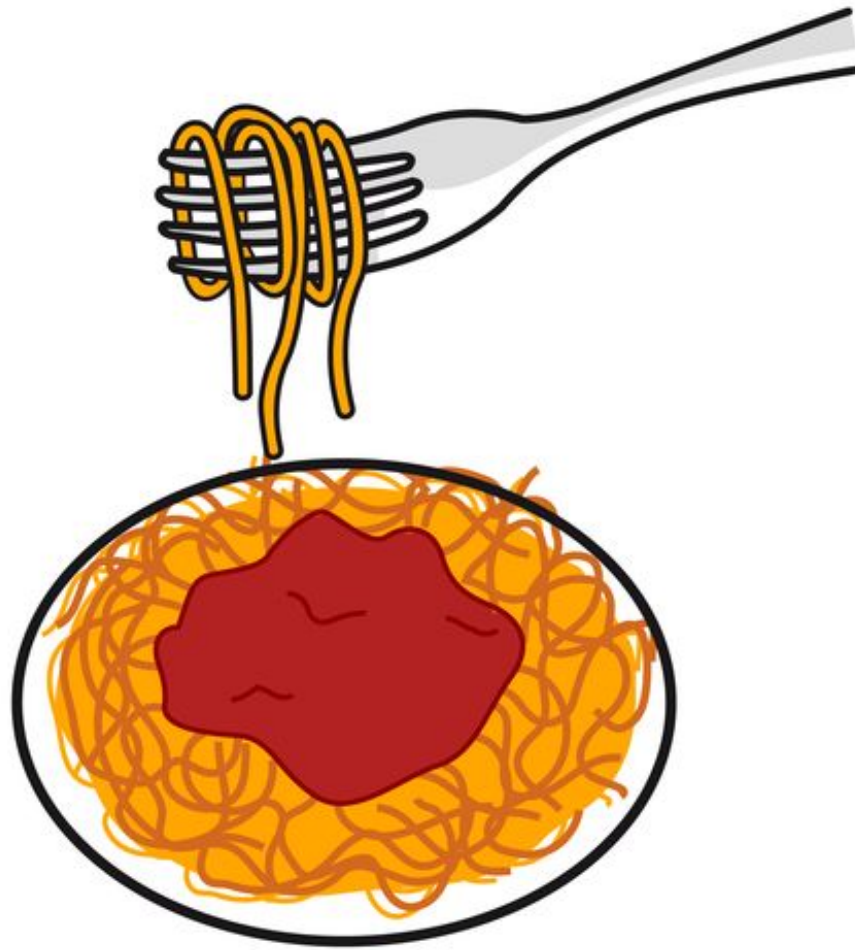

espaguetis

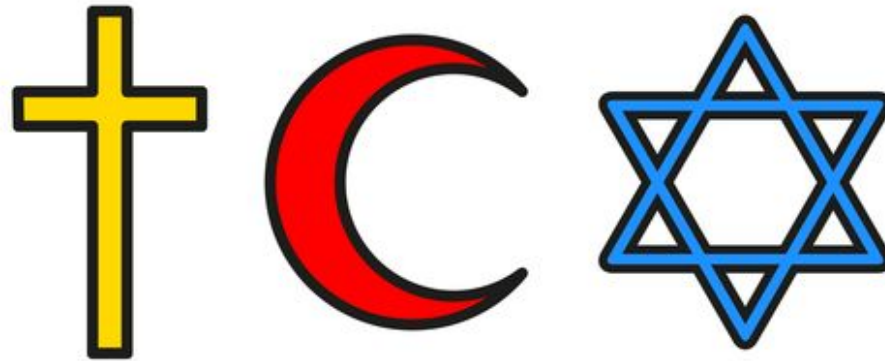

религија



гигант



guitarra

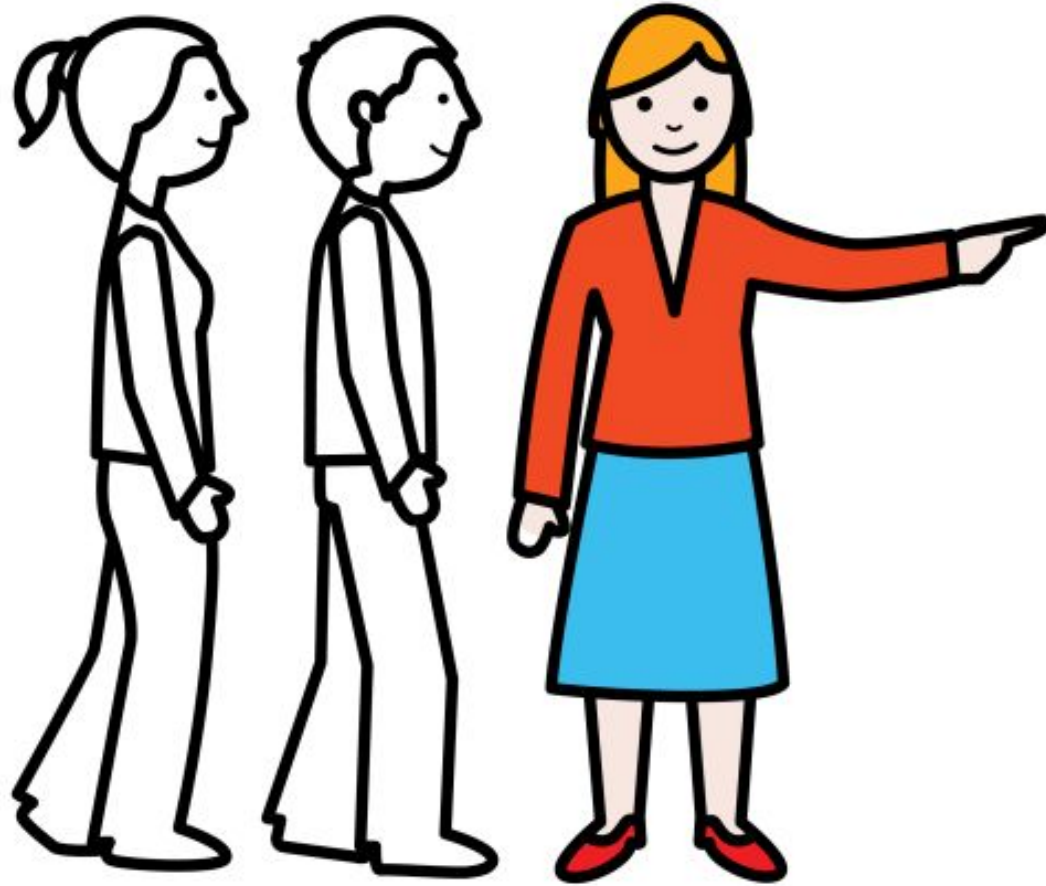

guía

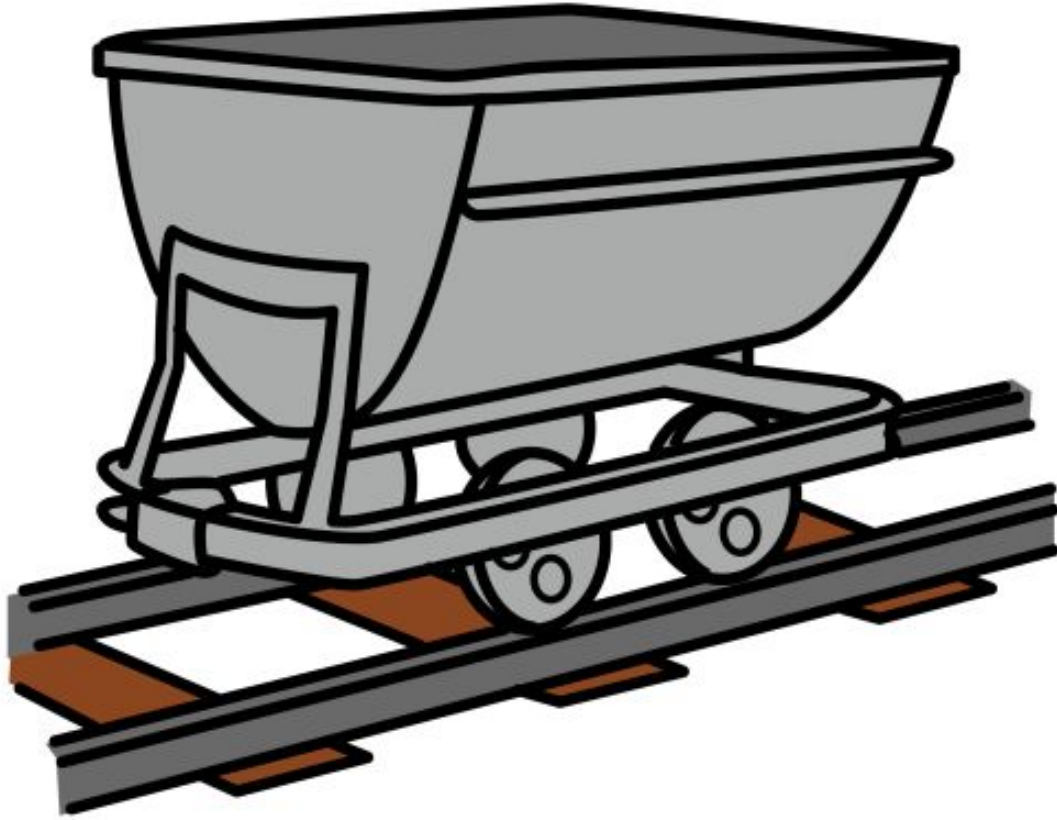

BagoH

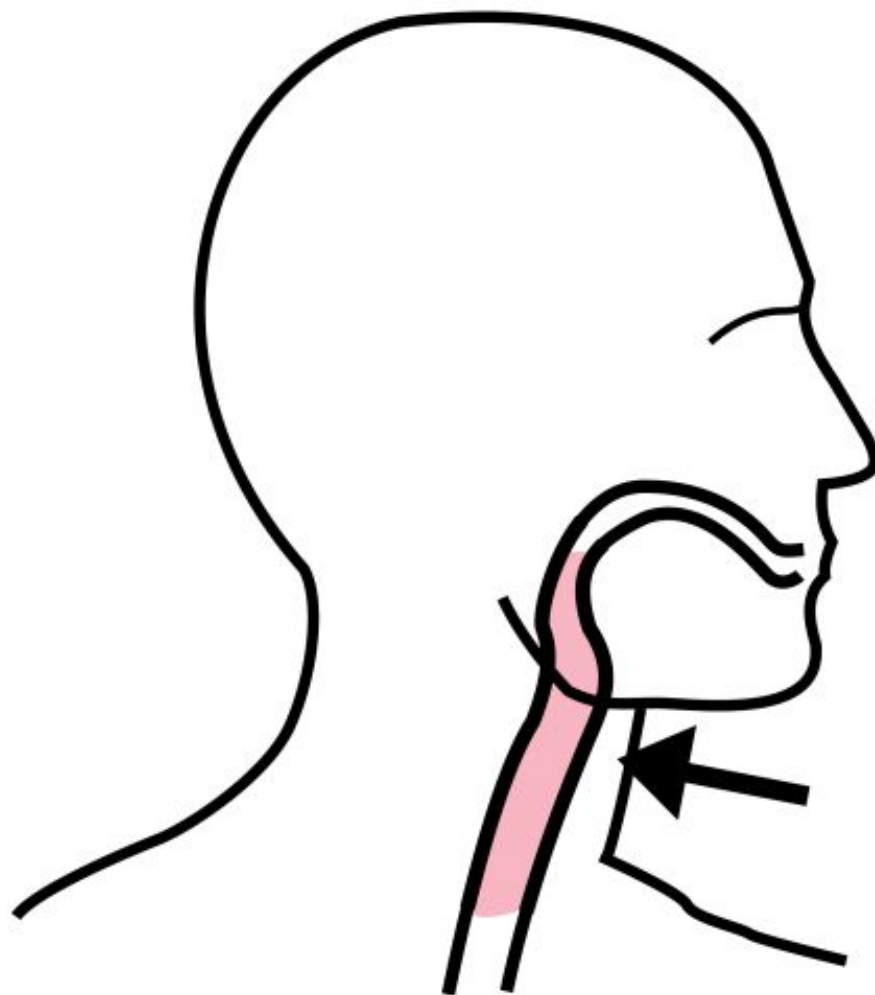

горло



погода

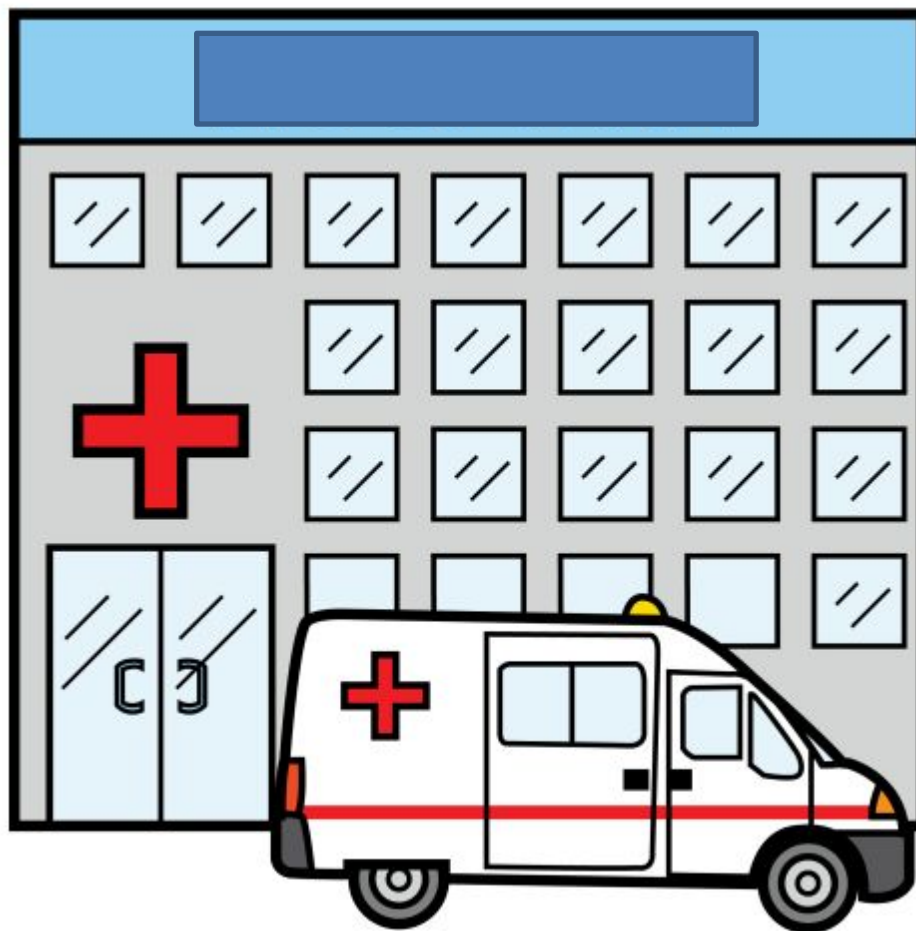

госпиталь

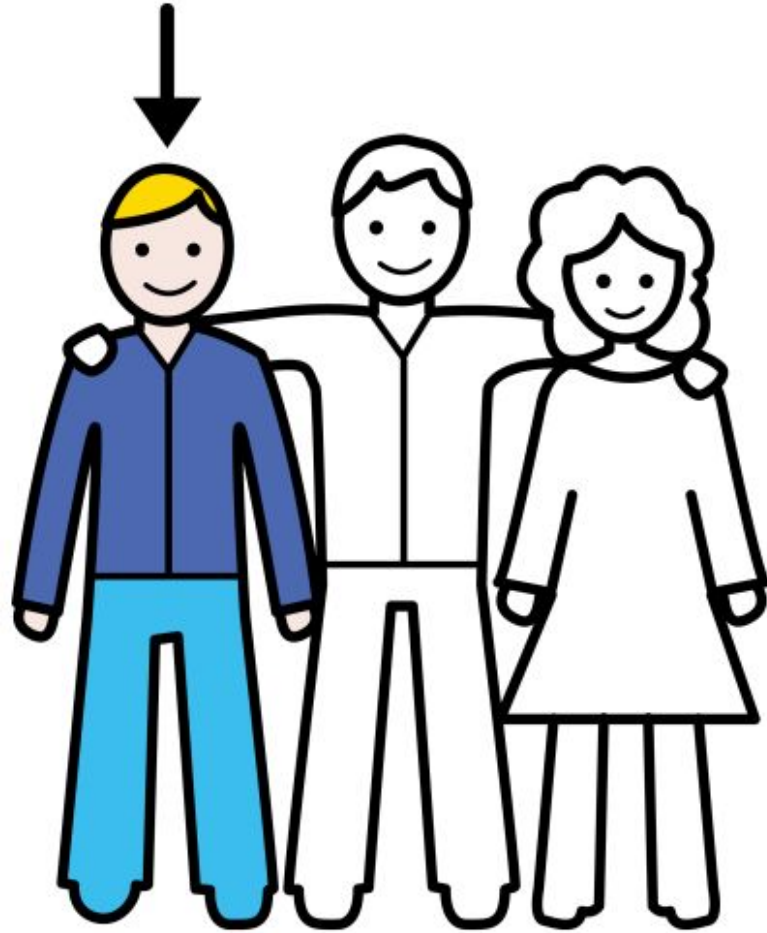

amigo



código



egoista

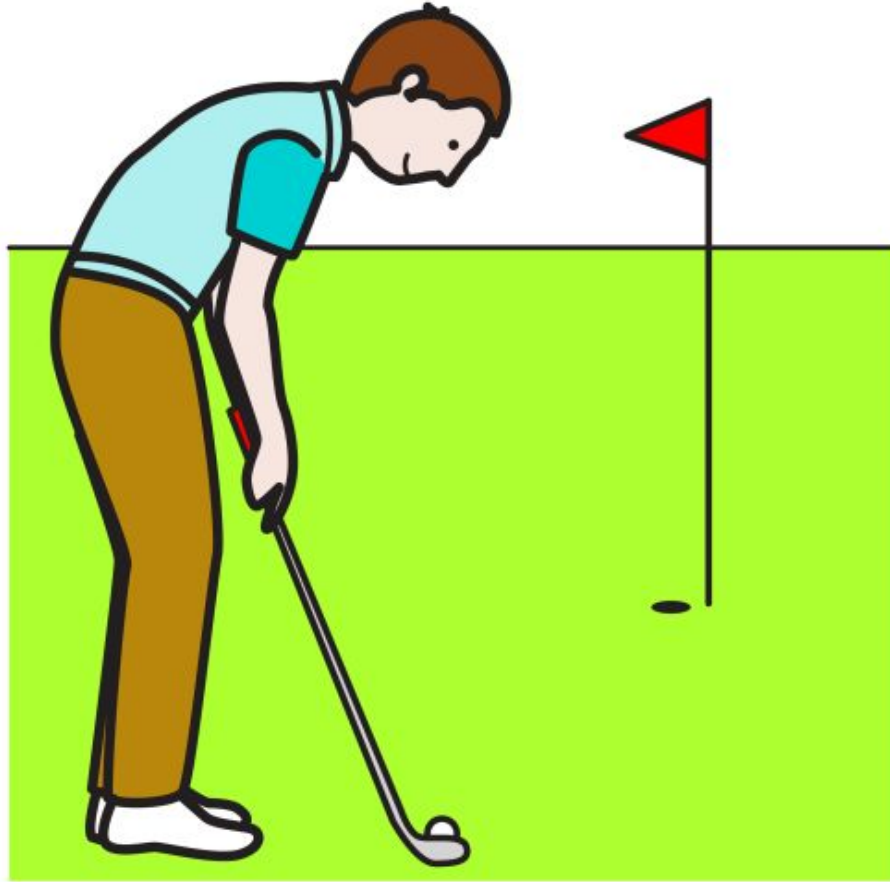

golf



аВgUCT



гулять

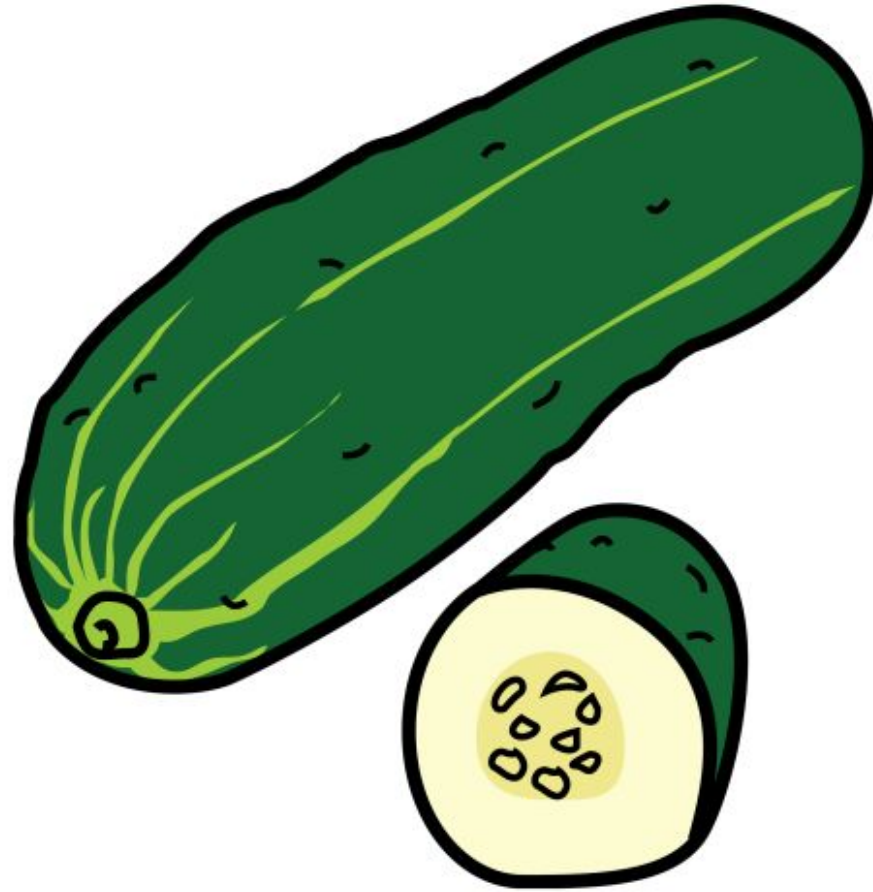

огурец

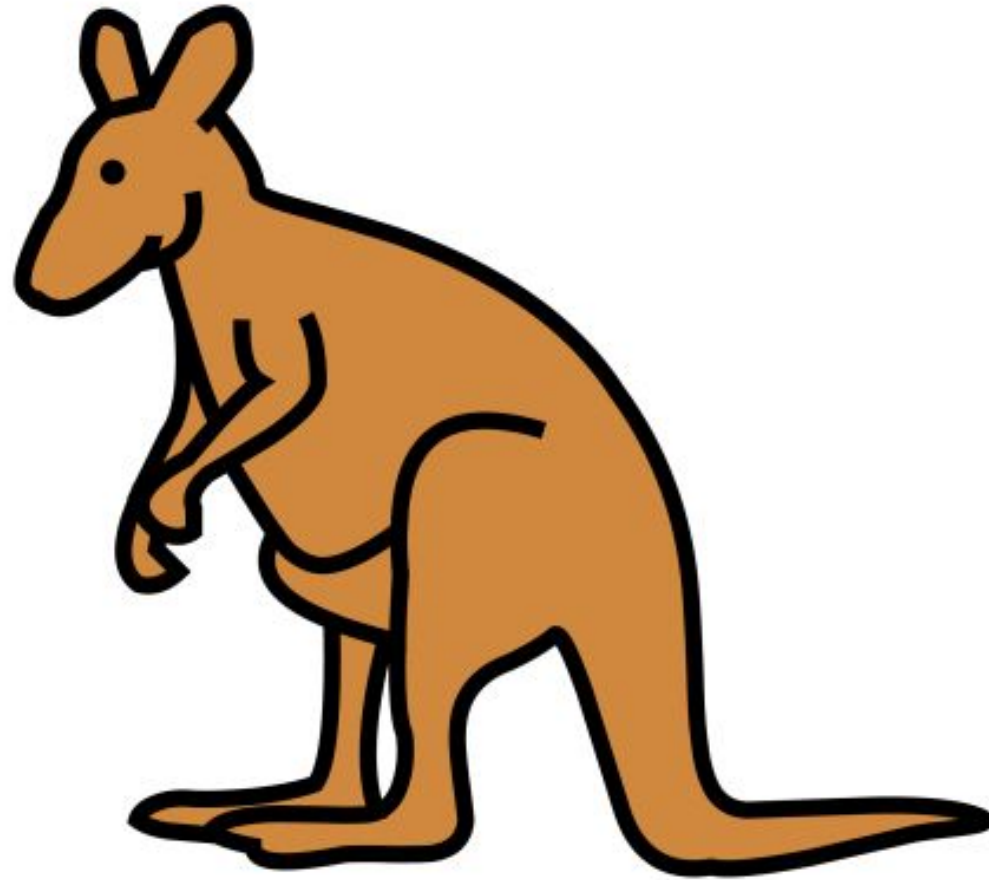

canguro



Uruguay



ingeniero



ángel



gente

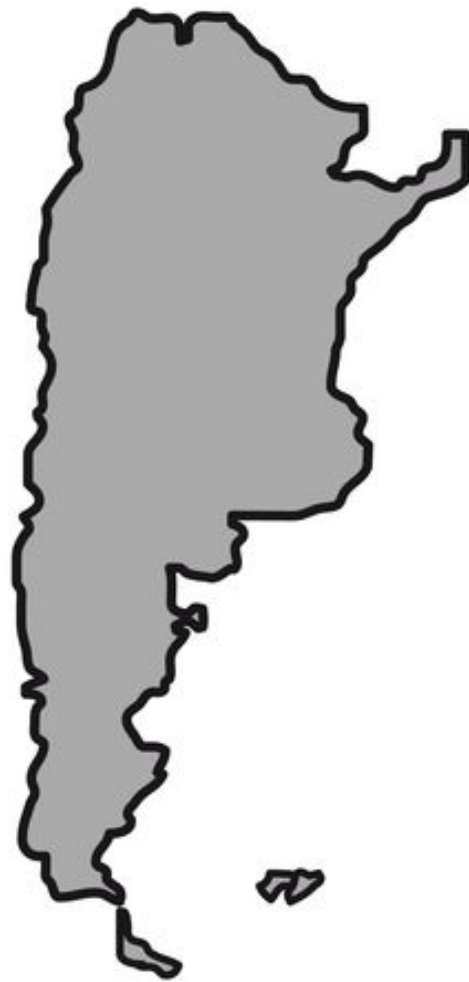

Argentina

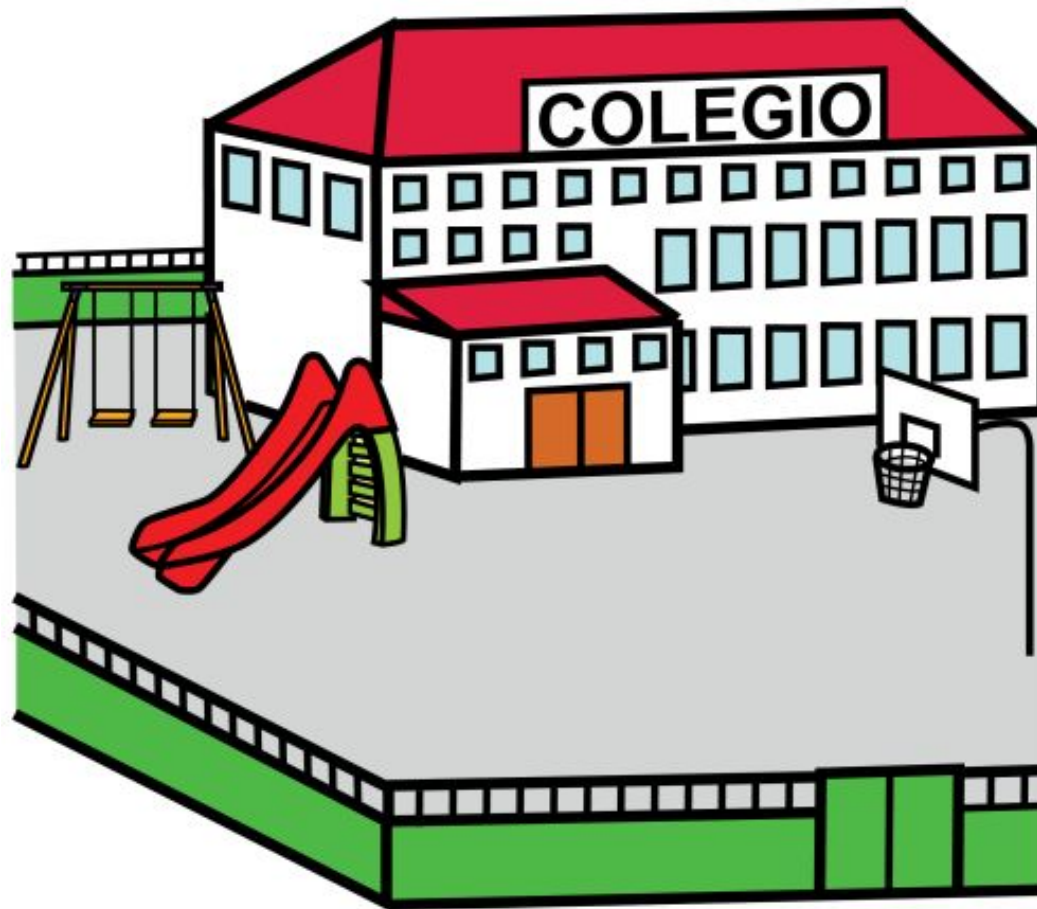

colegio

ZOO

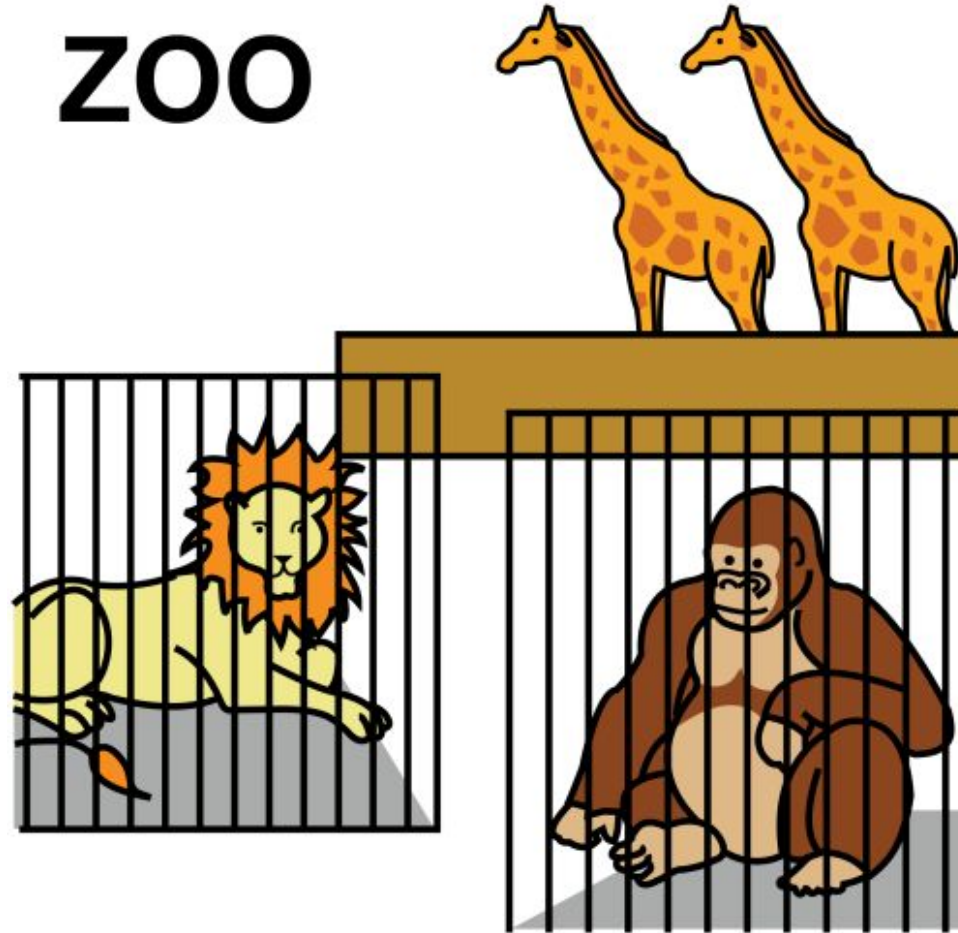

zoológico

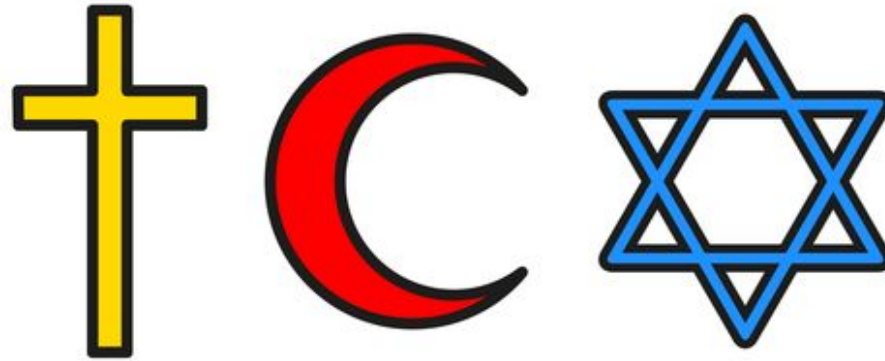

religión



gigante

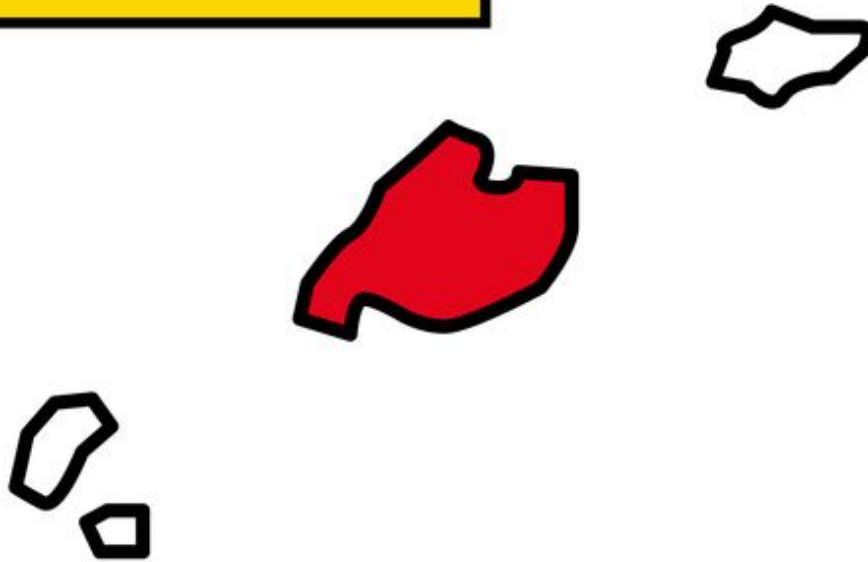
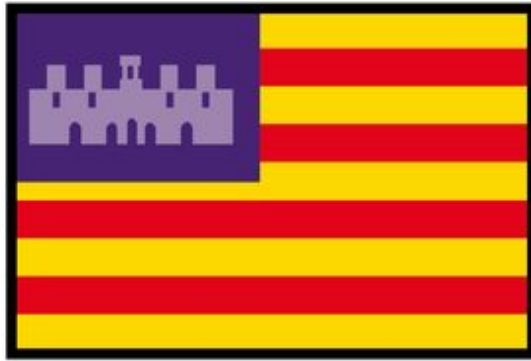

Mallorca



paella

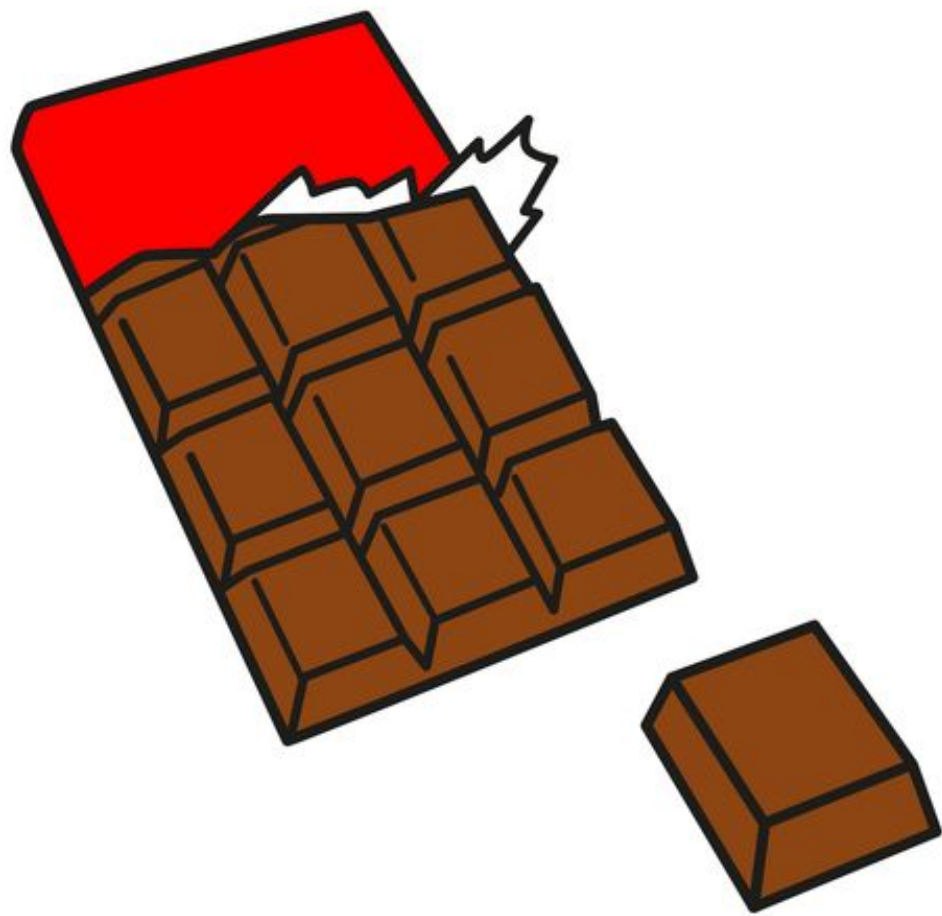

chocolate

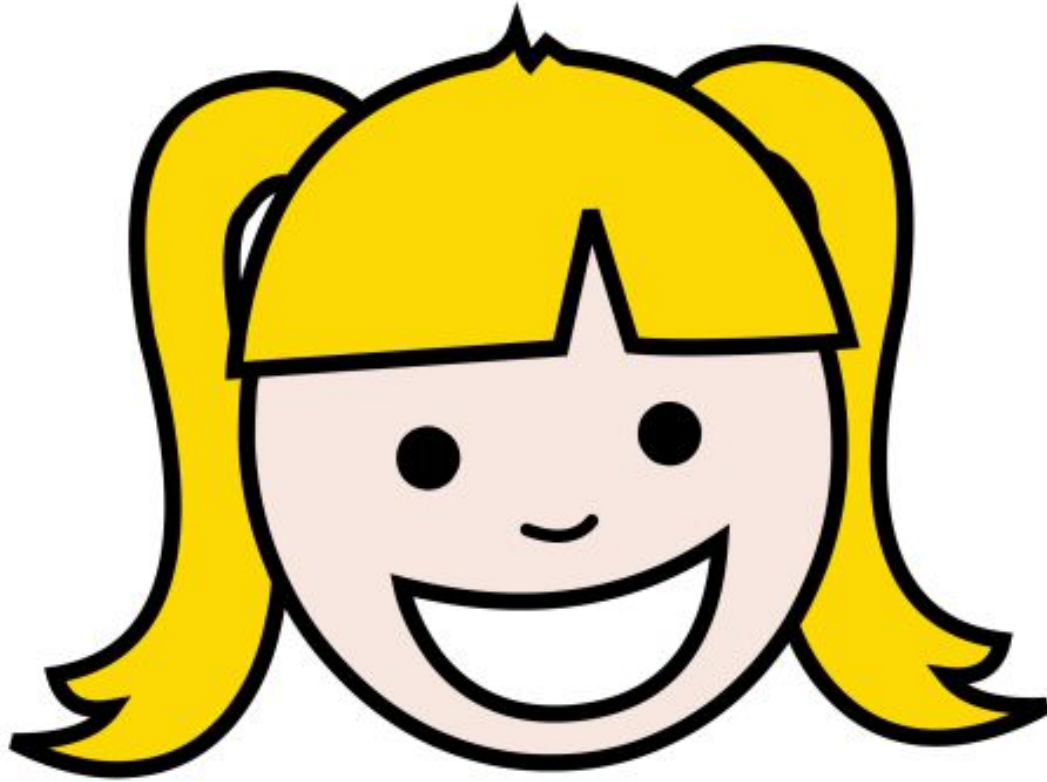

chica

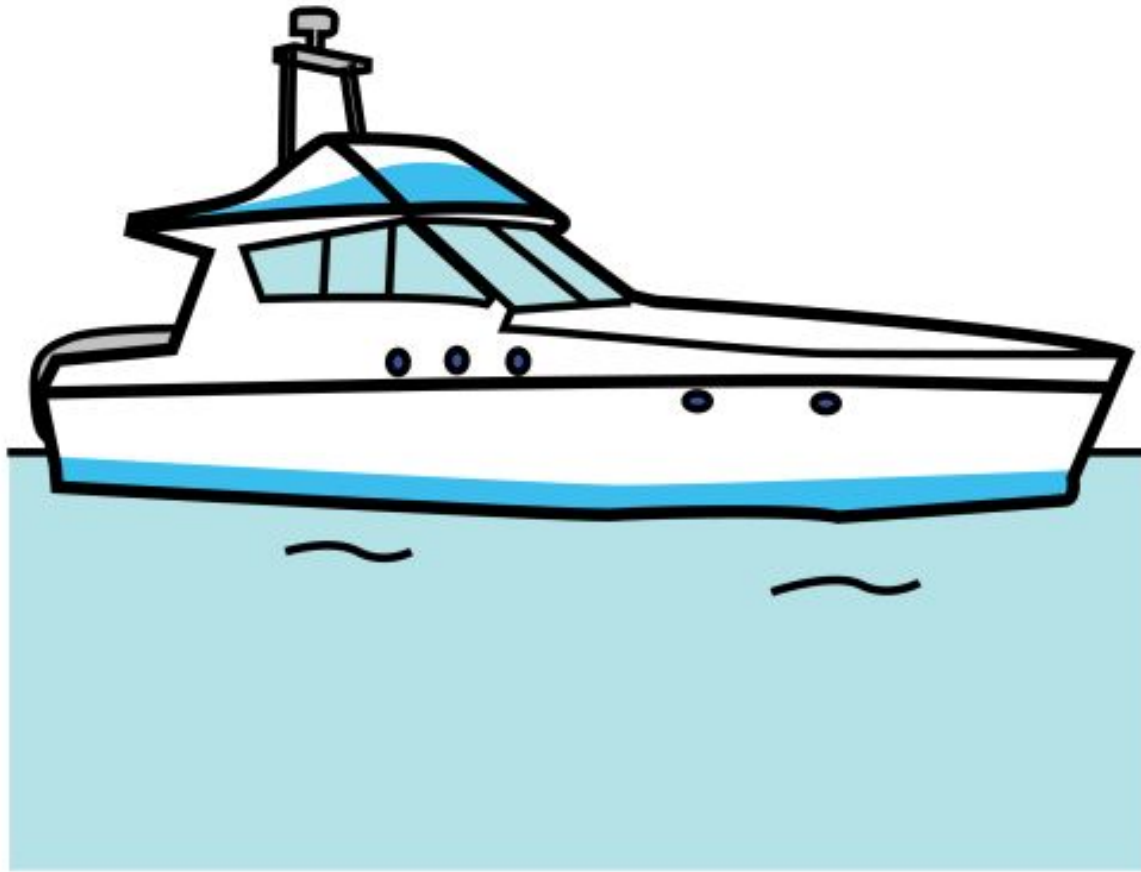

yate

Sonido: j - [x]

jefe

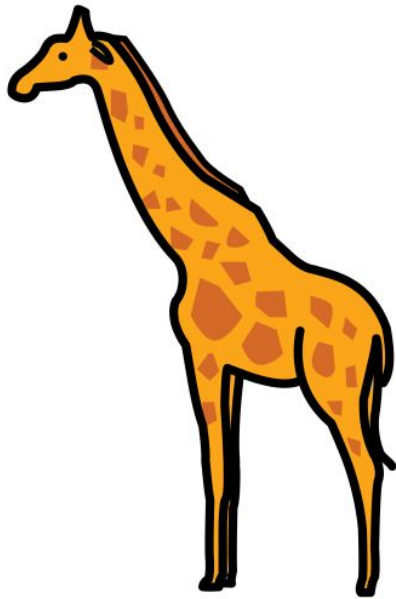

jirafa

Sonido [θ]

ZARA

zorro

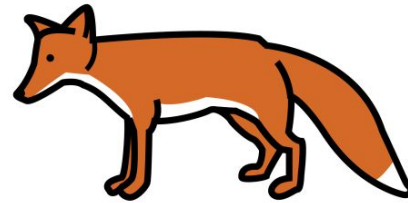

zumο

