

# Um Interface and Radio Channels

[www.huawei.com](http://www.huawei.com)





# Contents

1. **Overview**
2. Processing of Voice Signal
3. Radio Channel

# Radio Interface

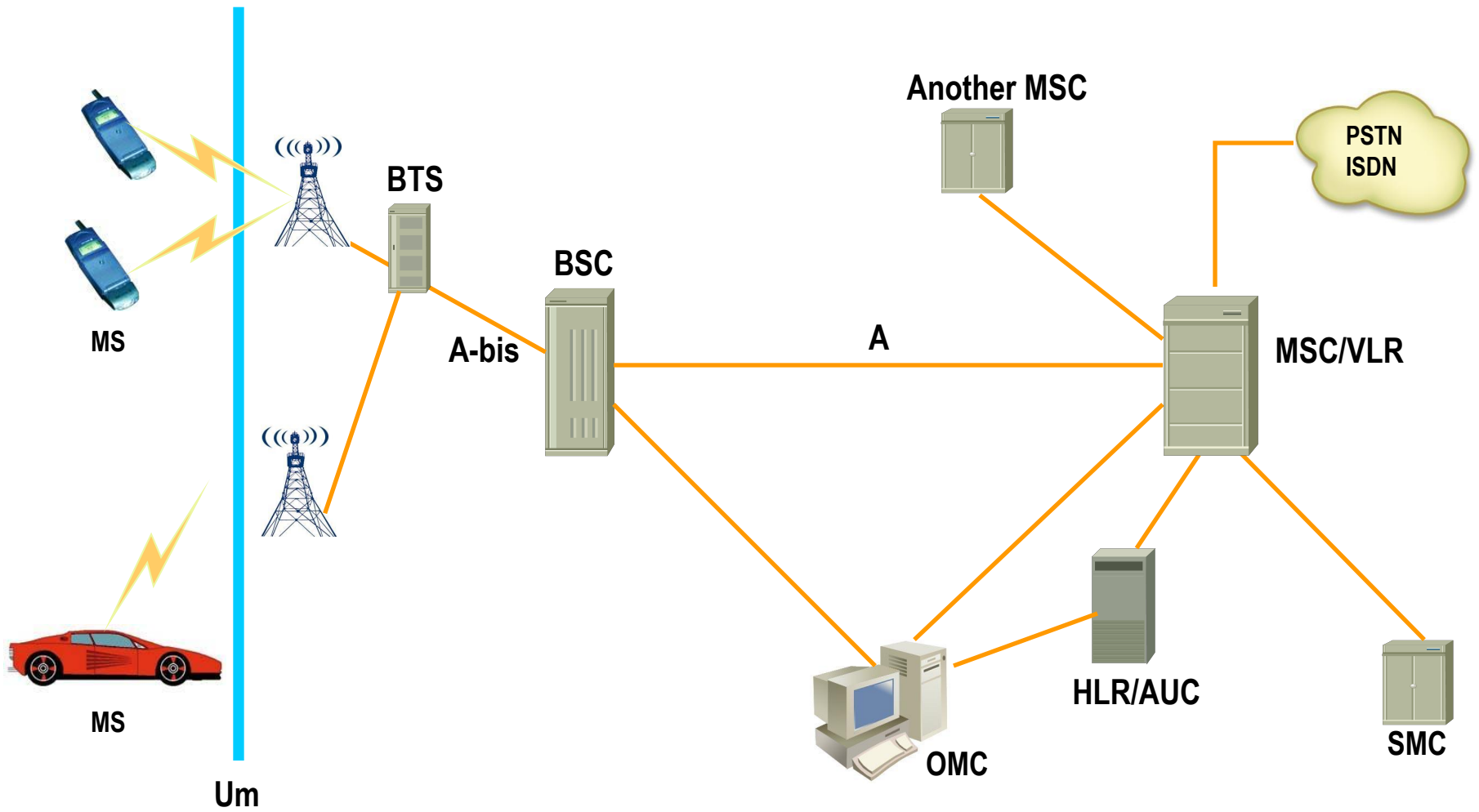

# Hierarchical Structure of Um Interface

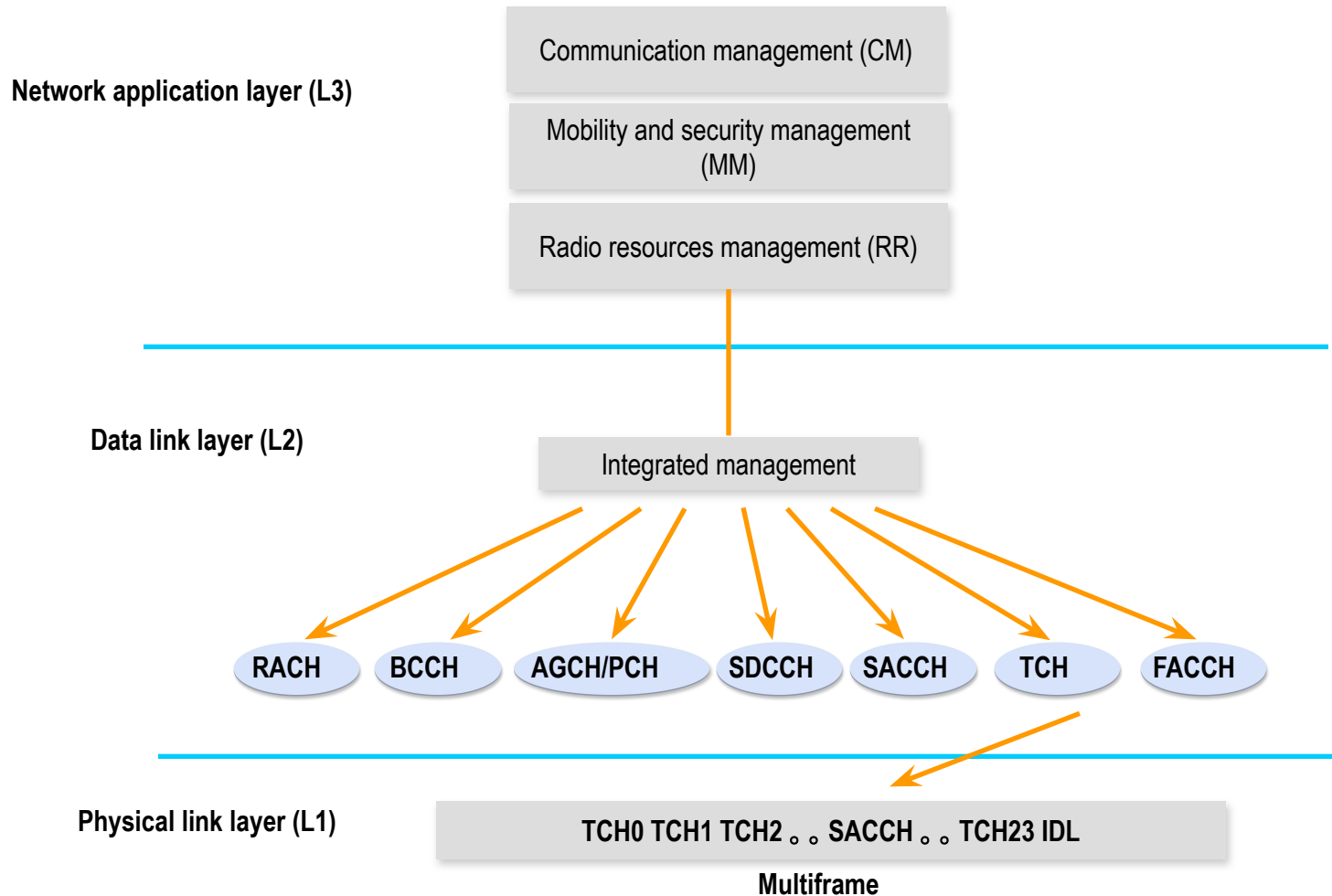

# Radio Access Technology

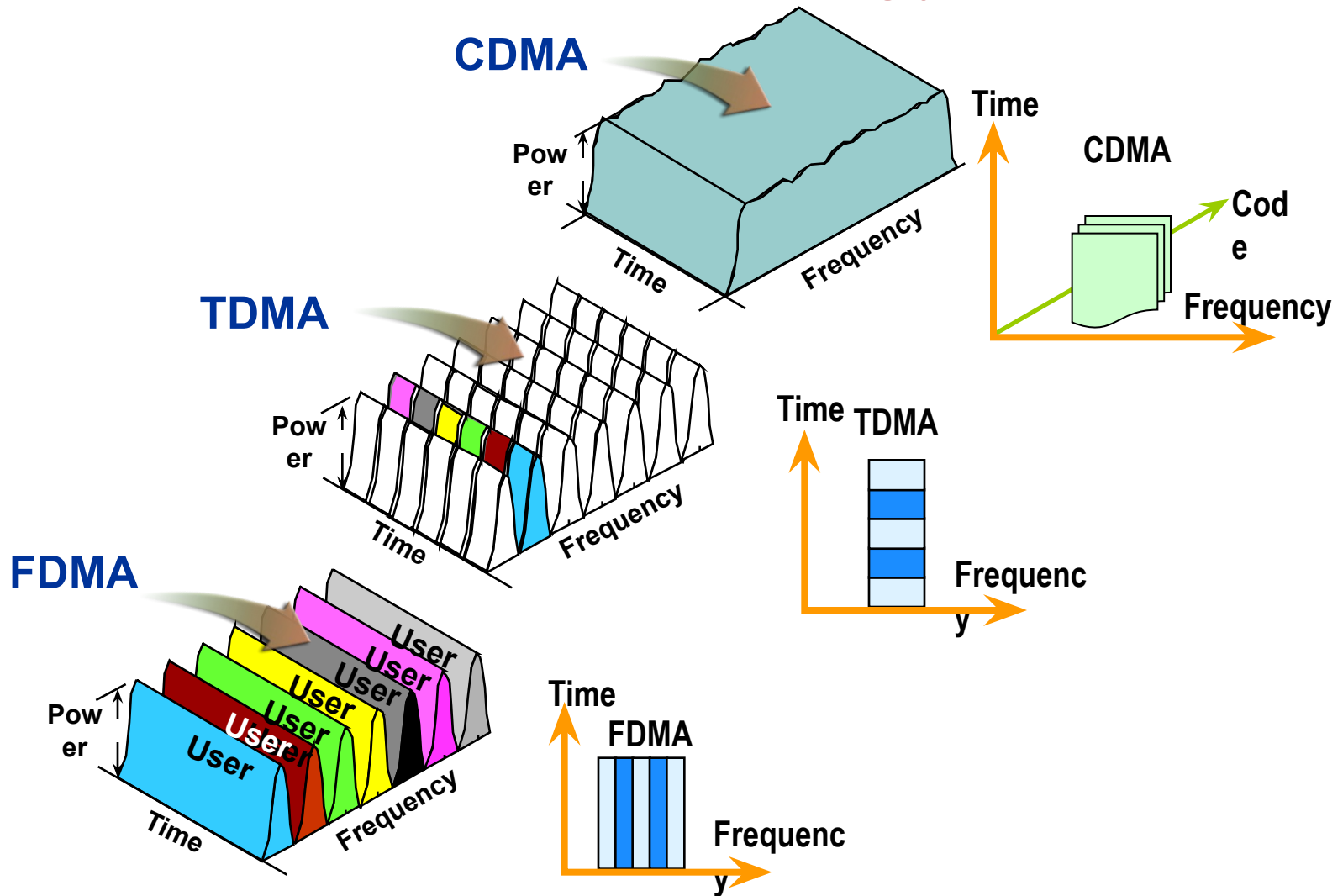

# Radio Access Technology

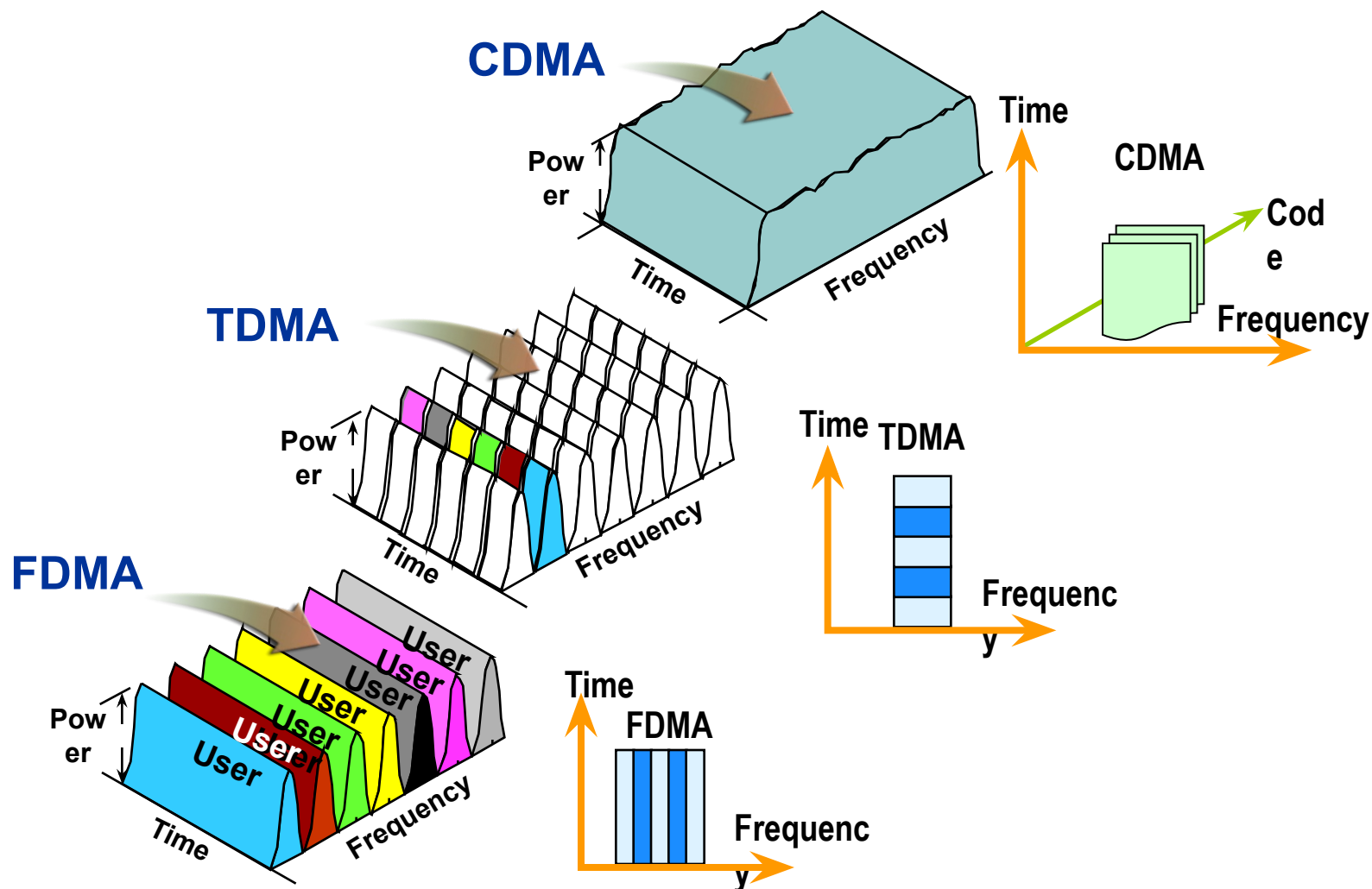



# Contents

1. Overview
2. **Processing of Voice Signal**
3. Radio Channel

# Voice Signal Processing

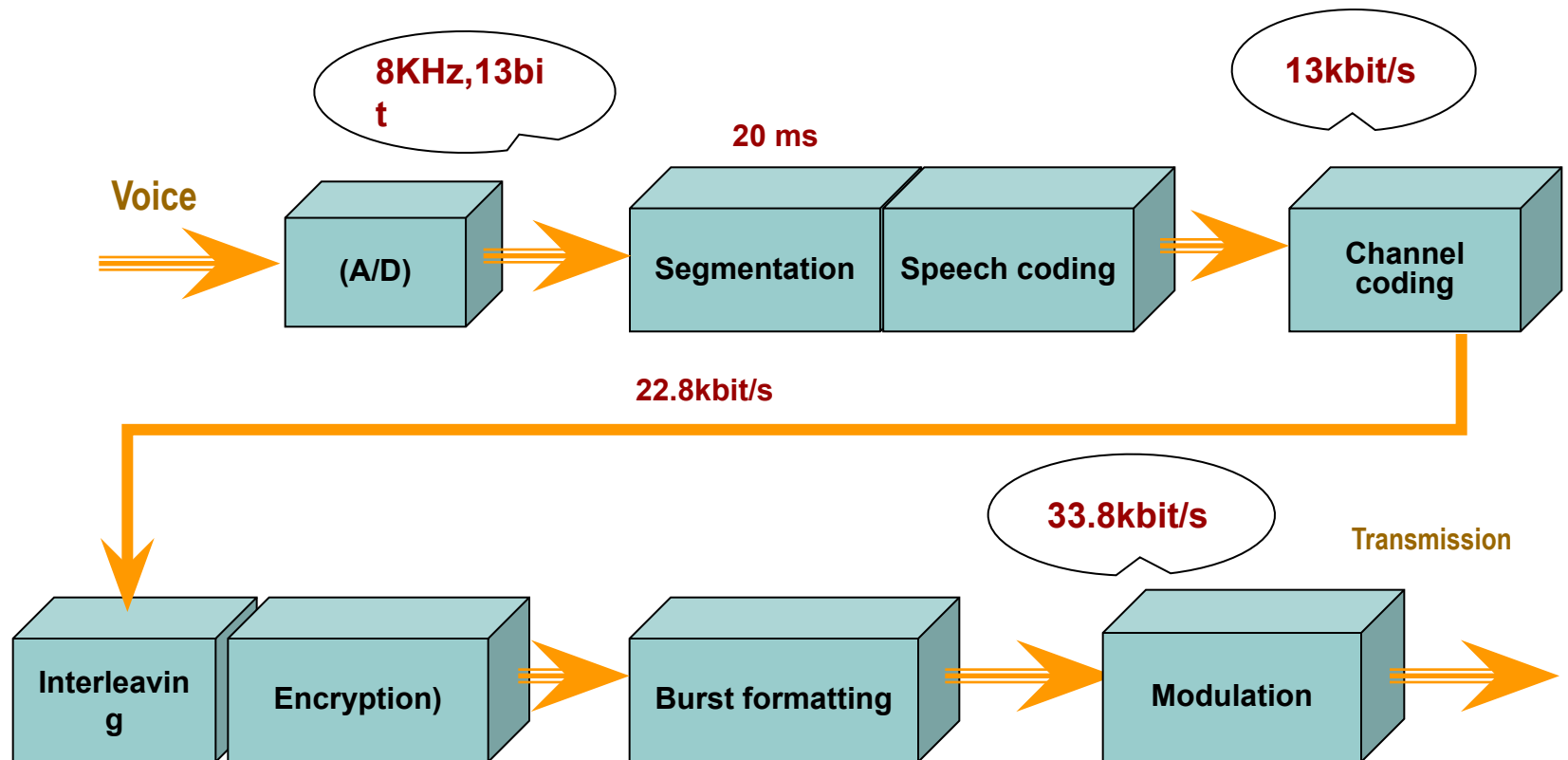



# Analog-Digital Conversion

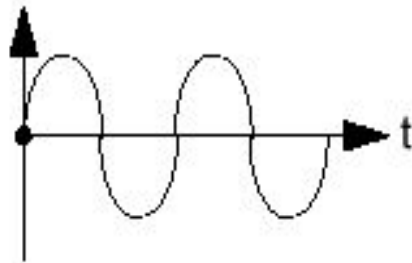
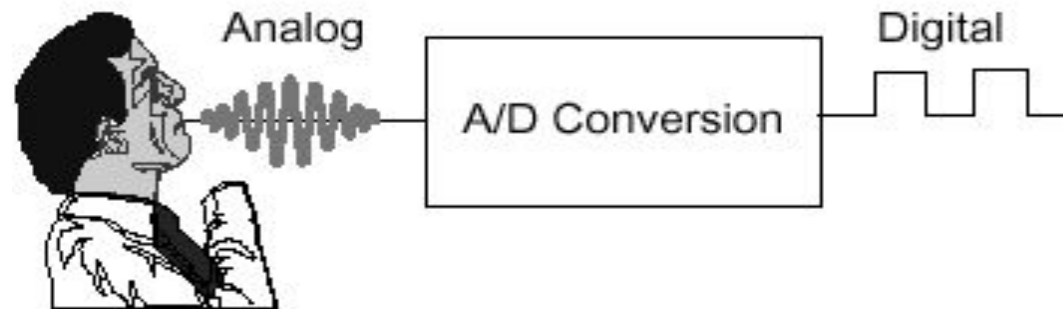

Analogue signal

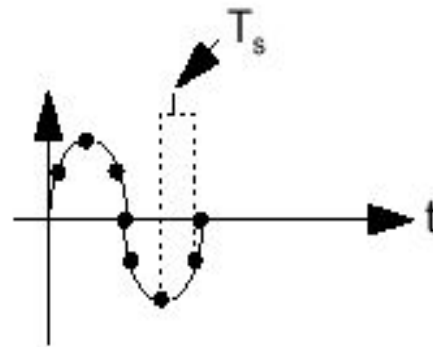

Sampling

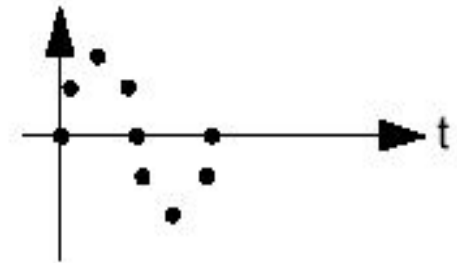

Sampled signal

# Speech Coding

- The *Enhance Full Rate* coding mode is called **CELP** (Code Excited Linear Predictive Coding)
- The *Full Rate* coding mode is called **RPE-LTP** (Regular Pulse Excited-Long Term Prediction).
- The *Half Rate* coding mode is called **VCELP** (Vector-Sum Excited Linear Prediction)

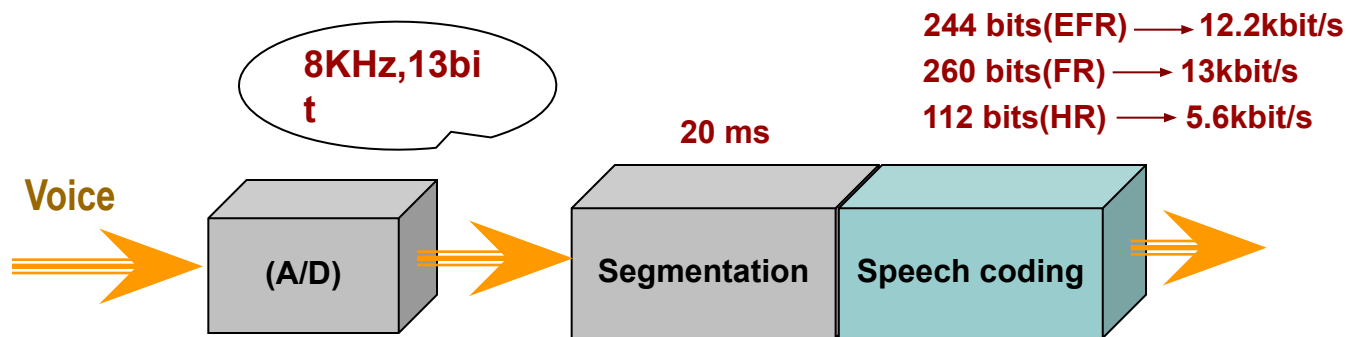

# Channel Coding

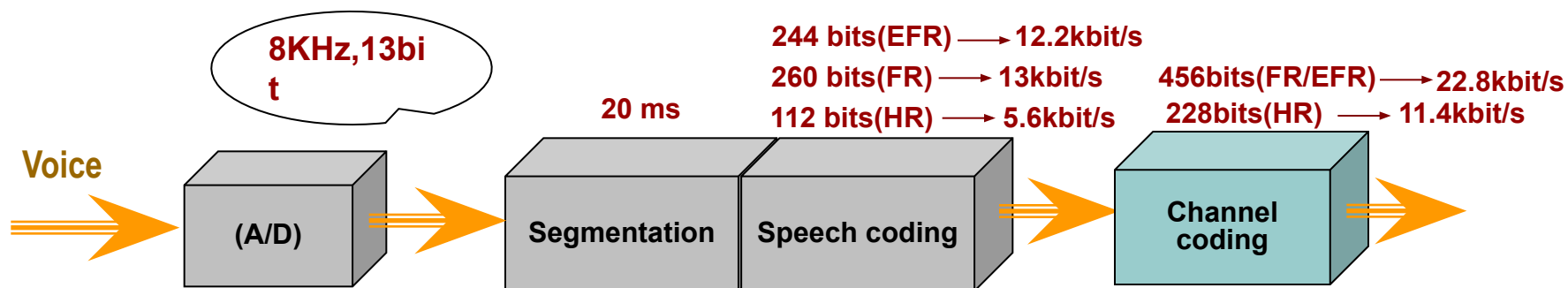
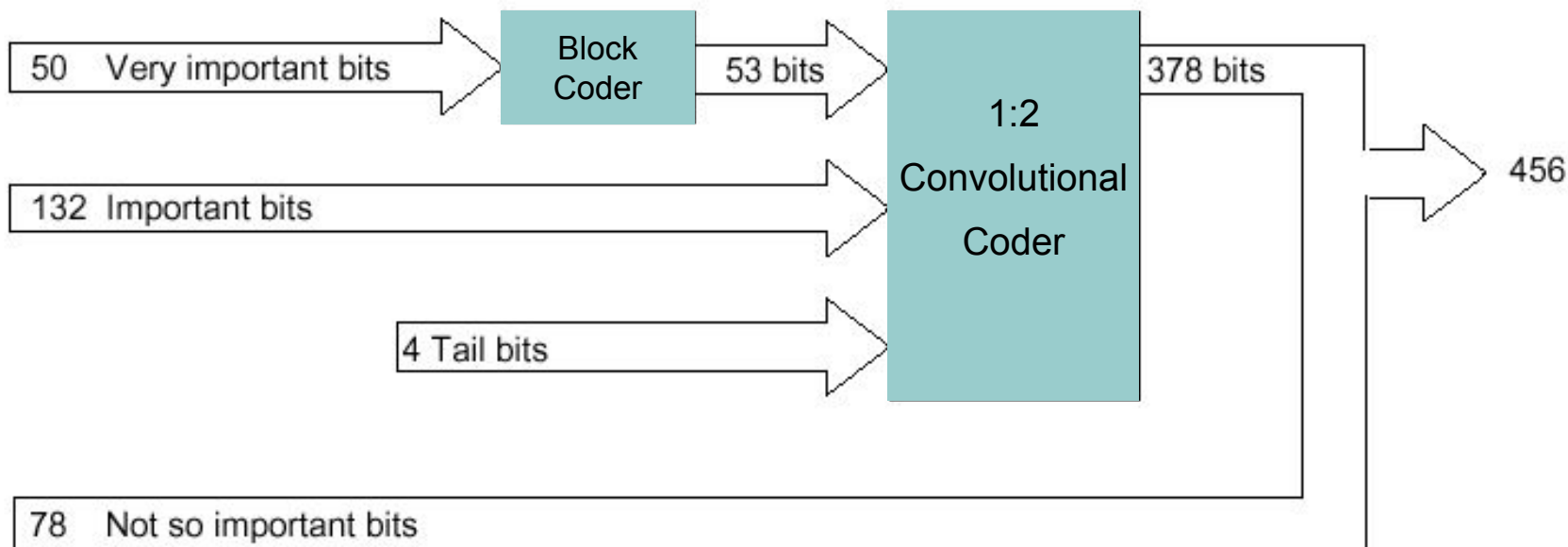

# Interleaving

**B**

1 2 3 4 5 6 7 8 ...

... 452 453 454 455 456

First interleaving:

B0 B1 B2 B3 B4 B5 B6 B7

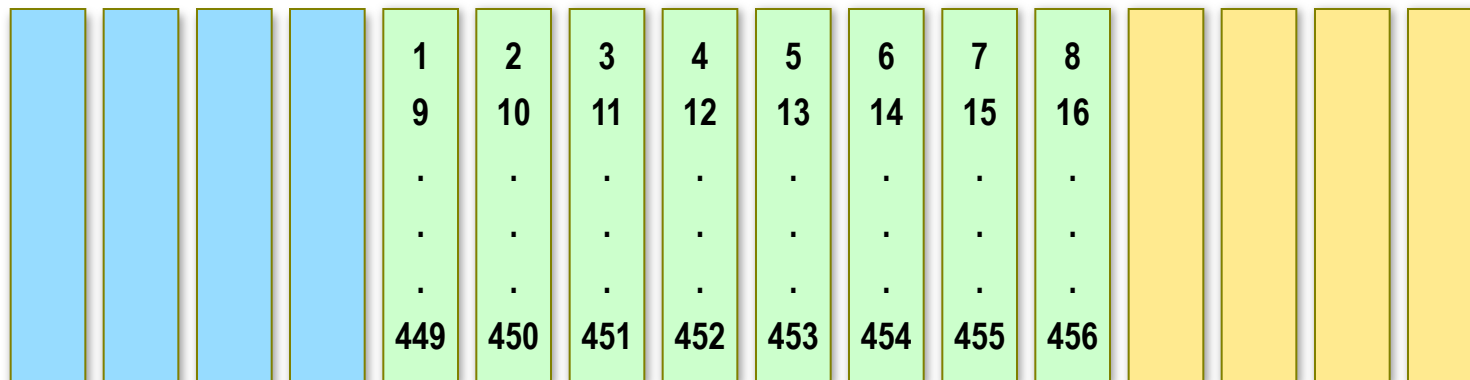

Second interleaving:

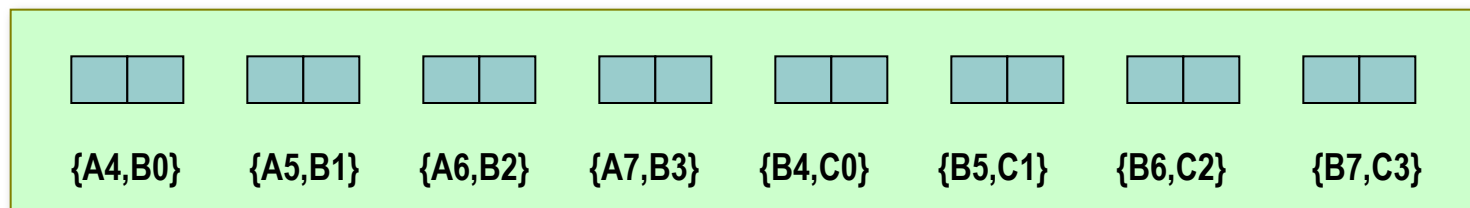

# Interleaving

**B**

1 2 3 4 5 6 7 8 ...

... 452 453 454 455 456

First interleaving:

B0 B1 B2 B3 B4 B5 B6 B7

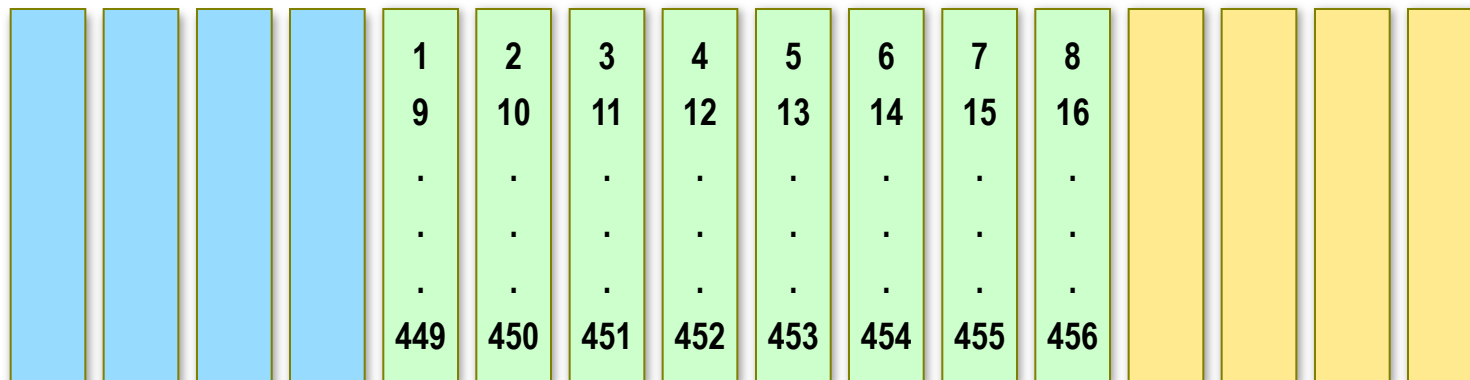

Second interleaving:

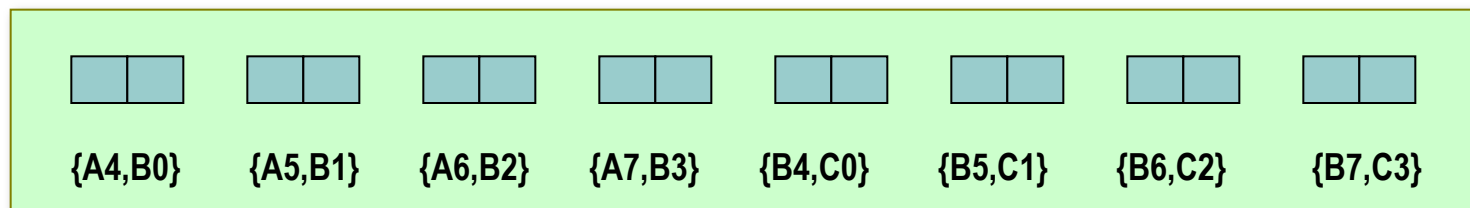

# Voice Burst

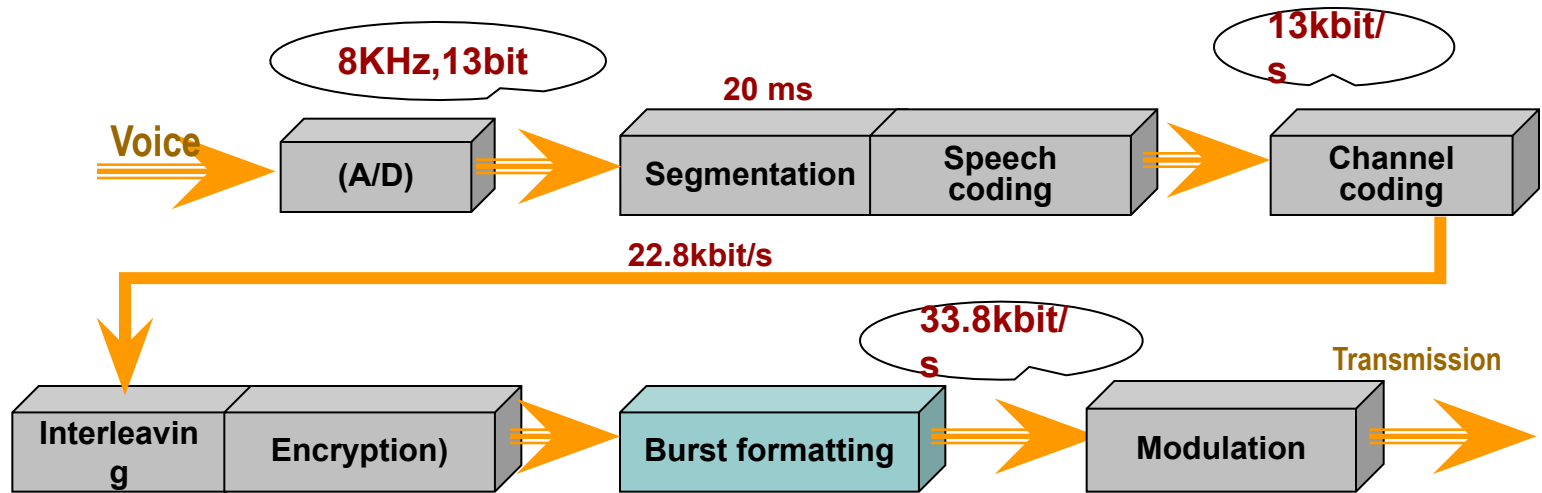
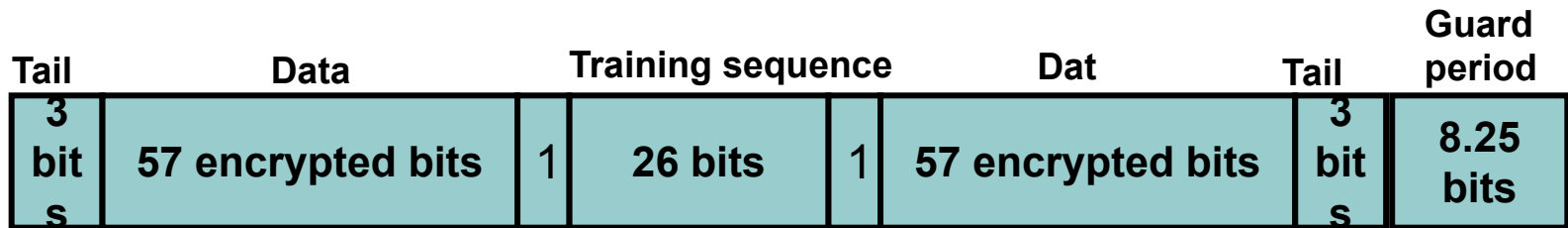

# Voice Signal Processing

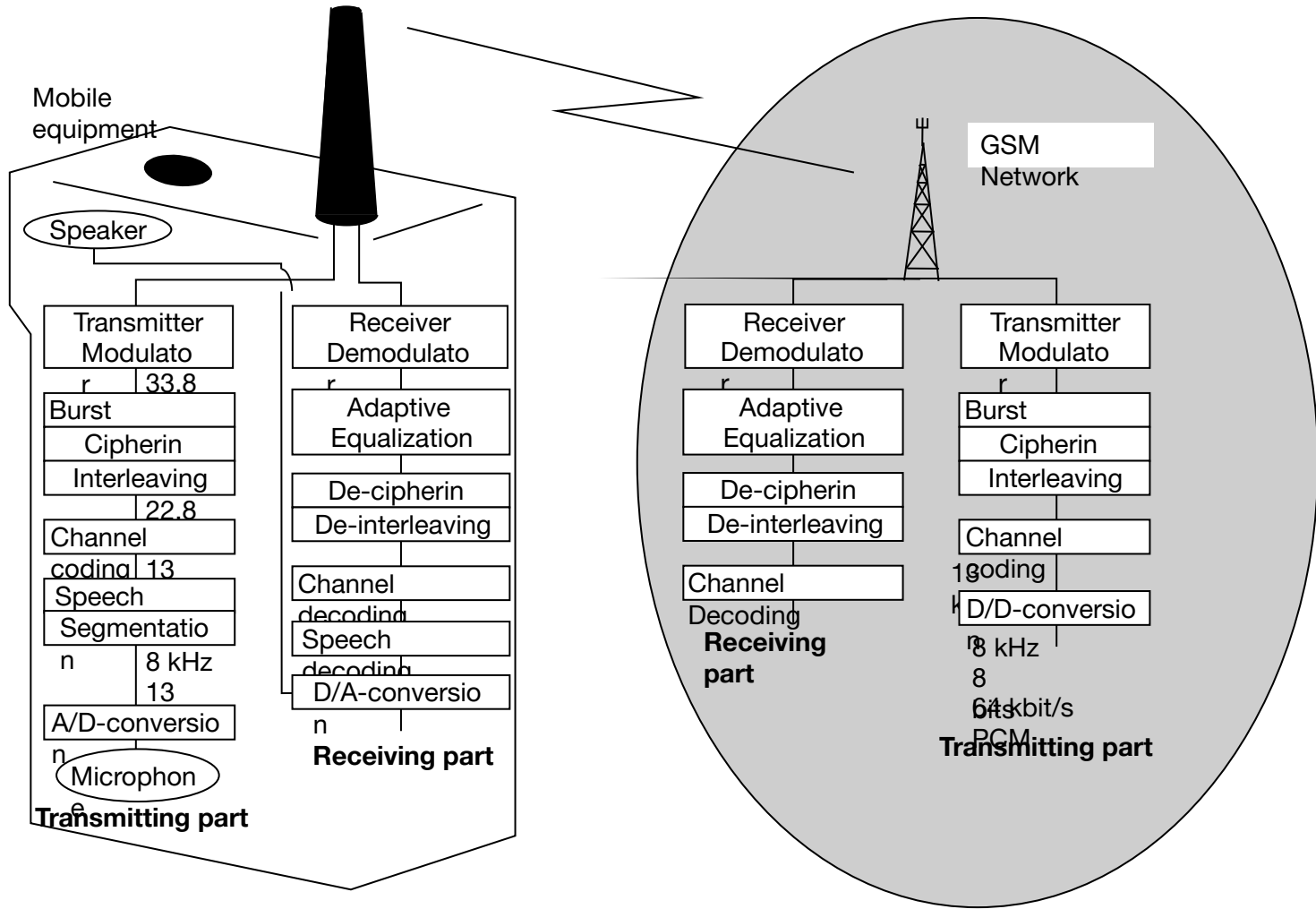

# Timing Advance (TA)

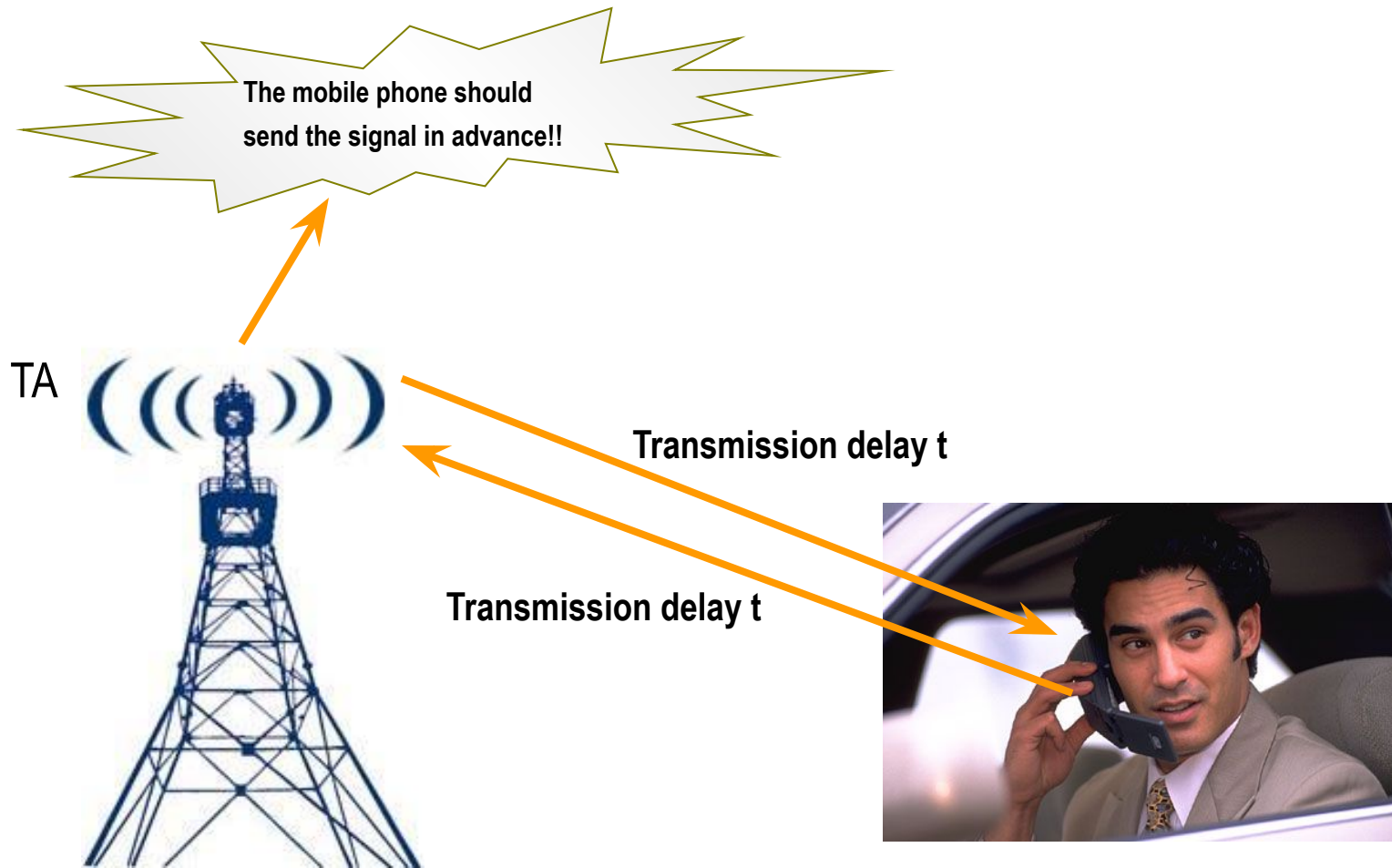



# Timing Advance (TA)

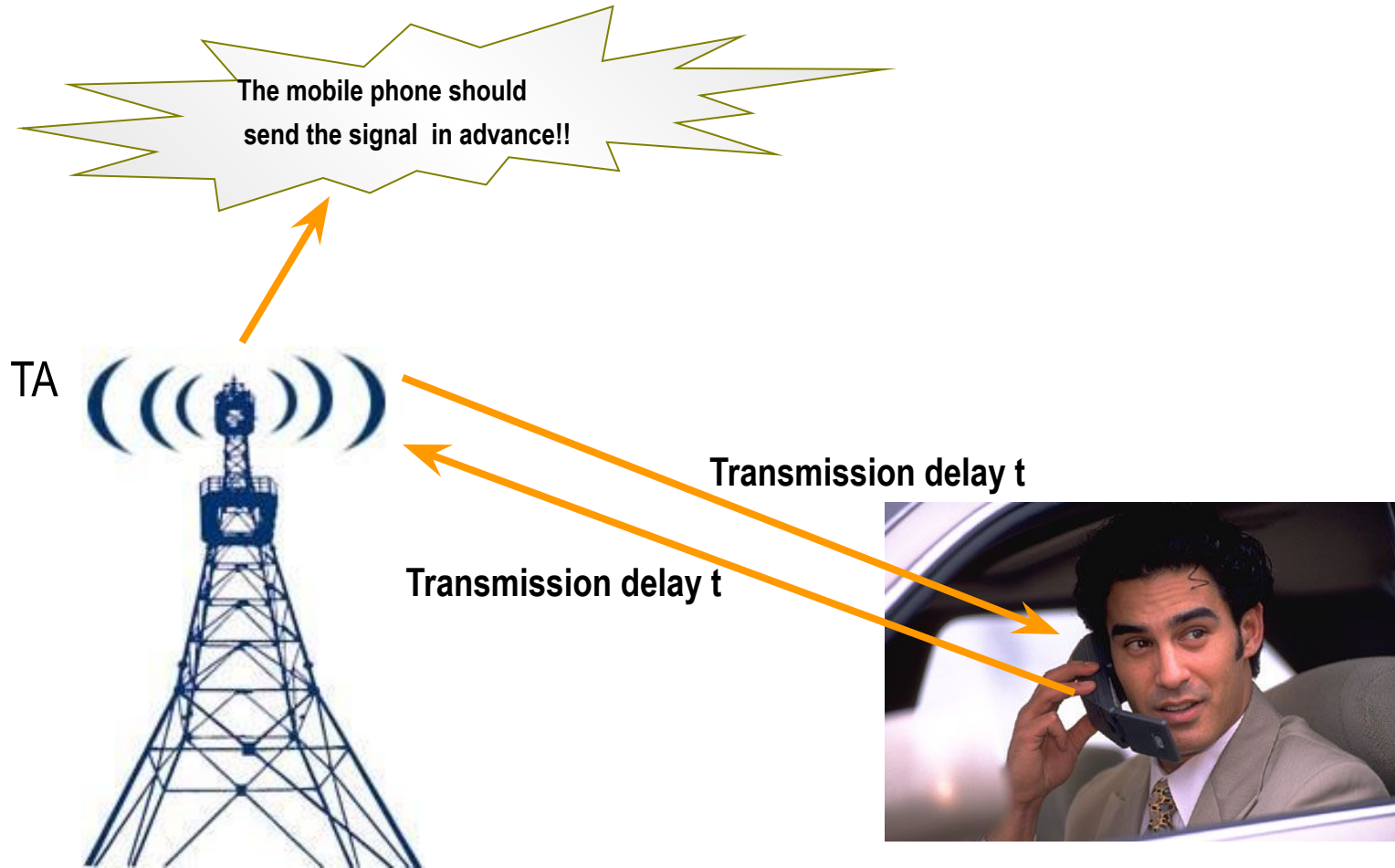

# Frequency Hopping

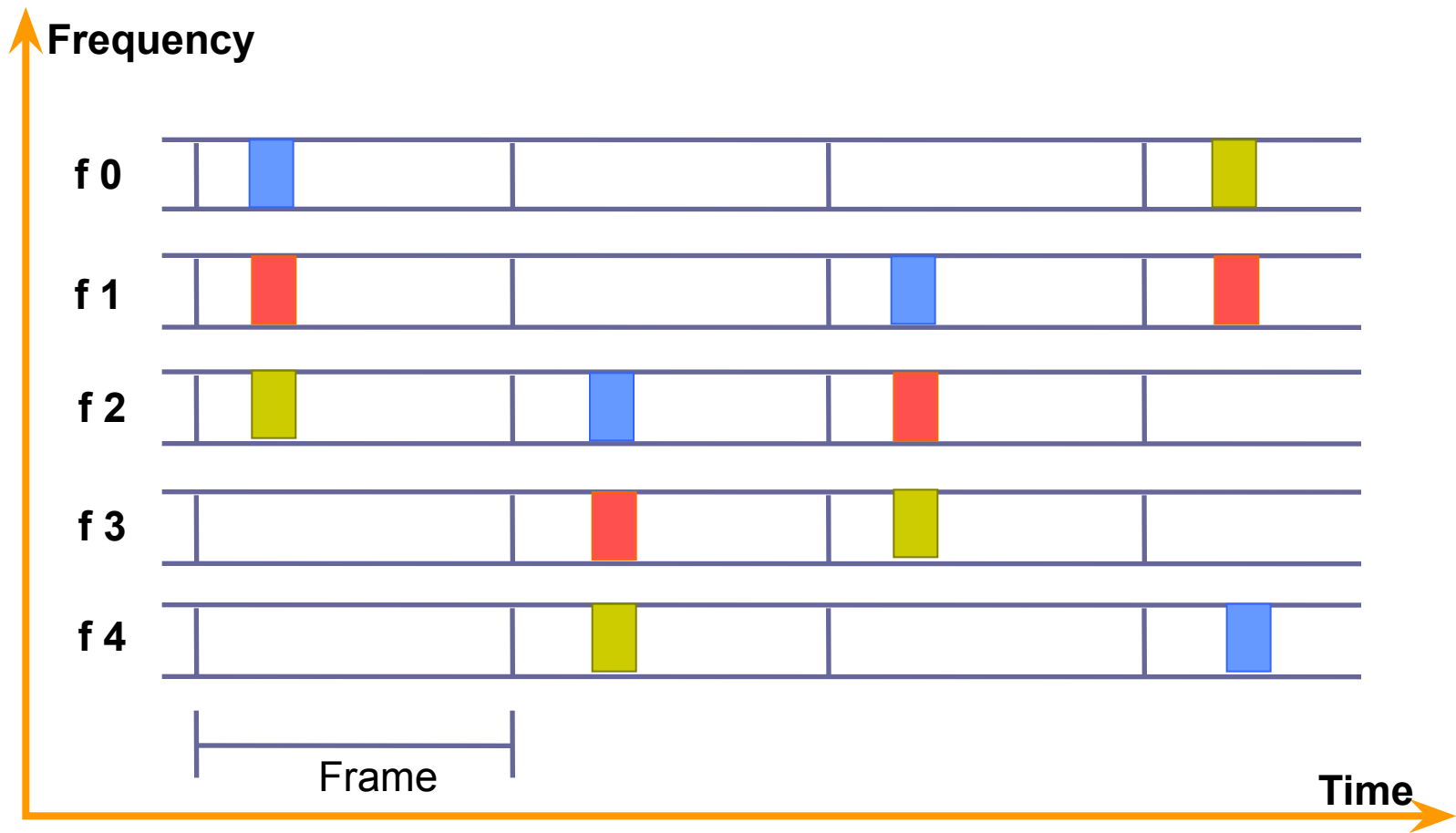



# DTX

- DTX: Discontinuous Transmission
  - Shut off the transmission at voice intervals;
  - Only transmit SID frames'
  - The transcoder at the RX terminal produces comfortable noise.
- VAD: Voice Activity Detection
  - Implemented by the transcoder.

**Prolong battery life and  
reduce interference**

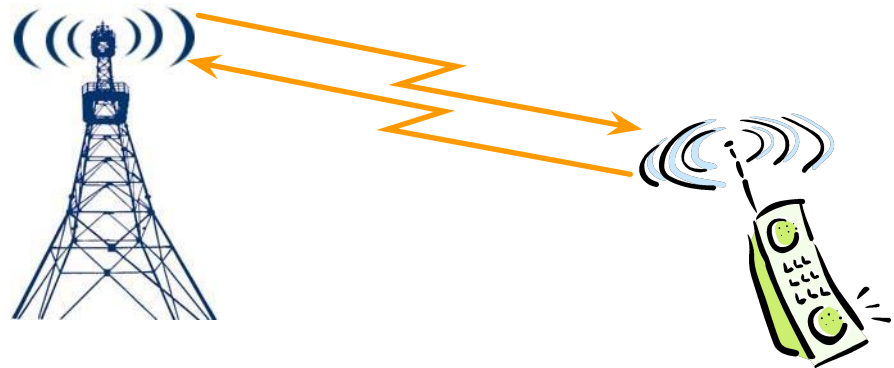

# DTX

- DTX: Discontinuous Transmission
  - Shut off the transmission at voice intervals;
  - Only transmit SID frames'
  - The transcoder at the RX terminal produces comfortable noise.
- VAD: Voice Activity Detection
  - Implemented by the transcoder.

**Prolong battery life and  
reduce interference**

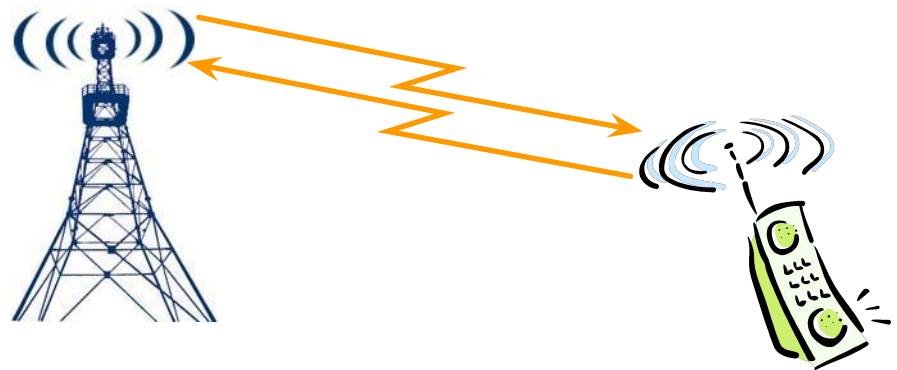

# Power Control

- Prolong battery life
- Reduce network interference
- Include both uplink power control and downlink power control
- Level and quality are taken into account
- BSC or BTS is the final adjudicator

**BCCH Carrier is not involved in power control.**

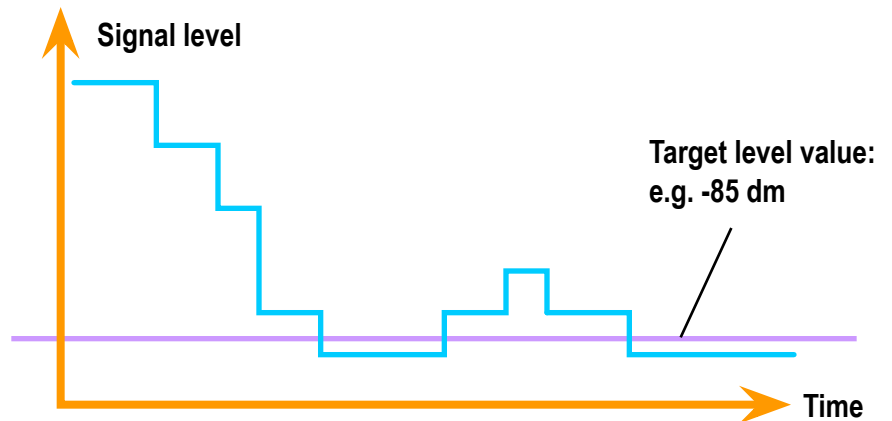



# Contents

1. Overview
2. Processing of Voice Signal
3. **Radio Channel**

# Frame and Channel

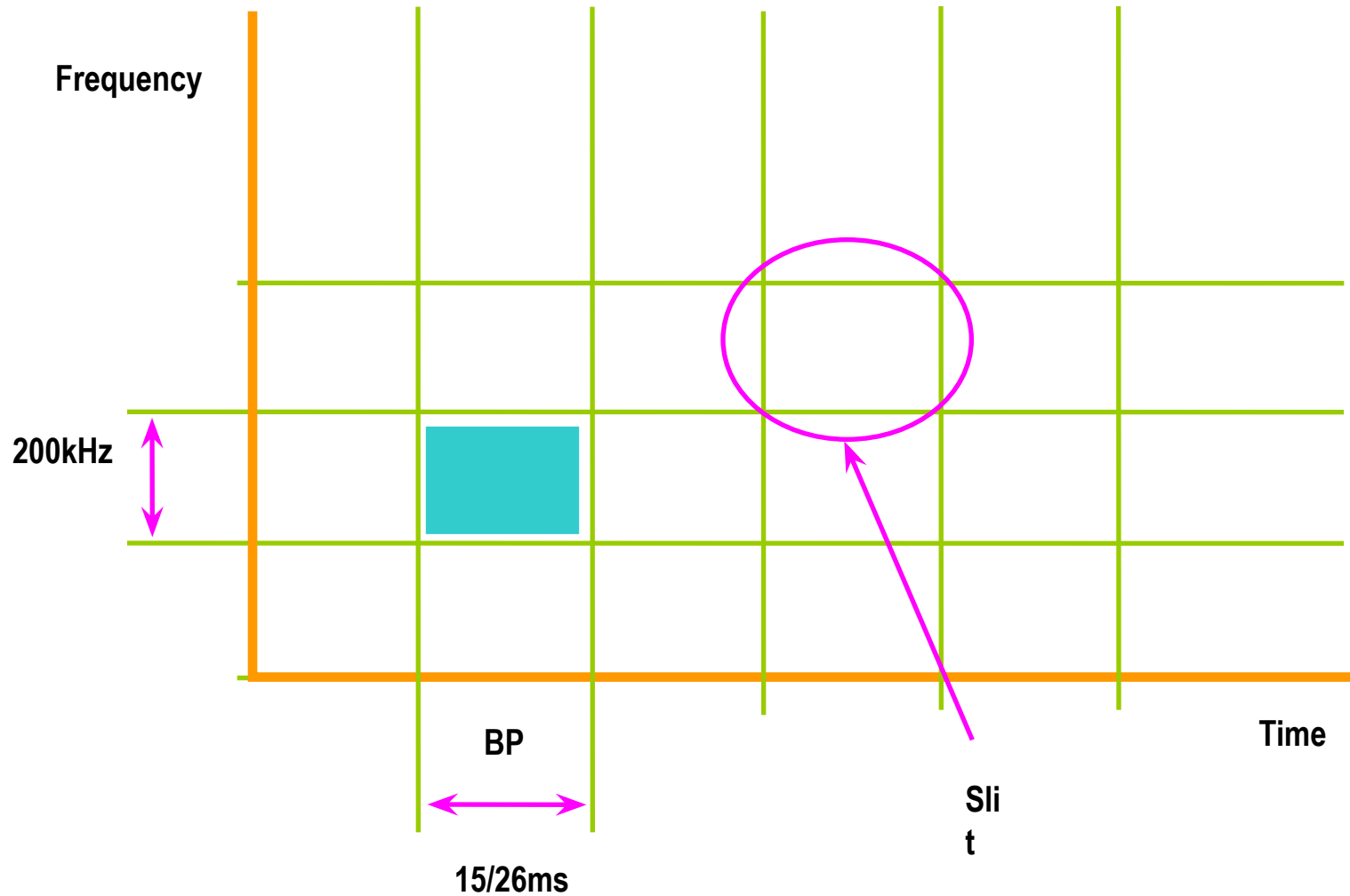



# Physical Channel of Logical Channel

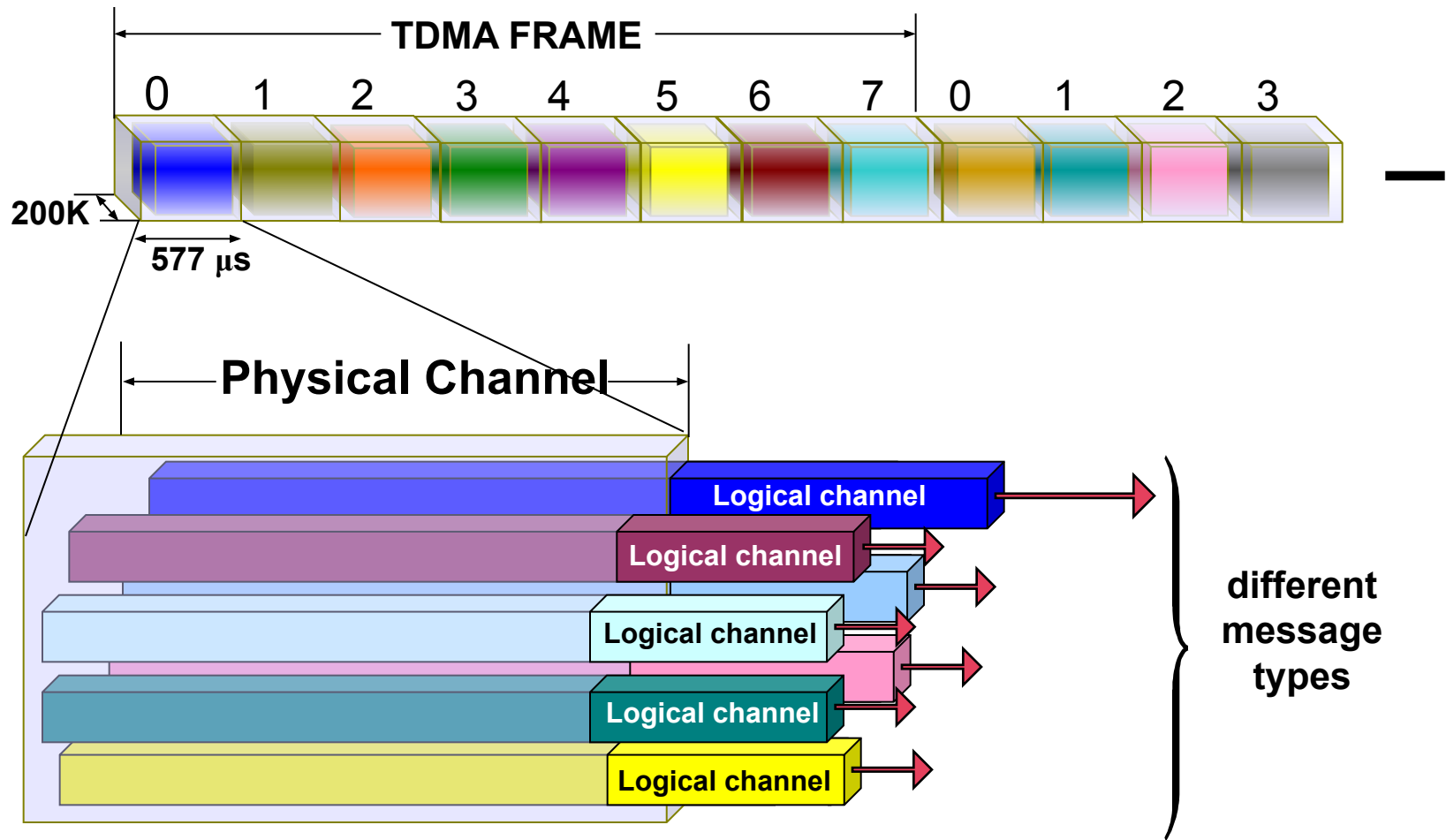

# Burst

- Access burst (AB): Used in MS initial access

Tail bit	Data	Tail bit	Guard interval	
<b>8bit</b>	<b>41 synchronous bits</b>	<b>36 encrypted bits</b>	<b>3bit</b>	<b>68.25bit</b>

- Frequency correction burst (FB): Used in frequency synchronization between MS and BTS

Tail bit	Data	Tail bit	Guard interval
<b>3bit</b>	<b>142bit</b>	<b>3bit</b>	<b>8.25bit</b>

- Synchronous burst (SB): Used in timing synchronization between MS and BTS

Tail bit	Data	Data	Tail bit	Guard interval	
<b>3bit</b>	<b>39 encrypted bits</b>	<b>64 synchronous bits</b>	<b>39 encrypted bits</b>	<b>3bit</b>	<b>8.25bit</b>

# Burst

- Normal burst (NB)
  - Used to carry the information of the traffic channel and the control channel except for RACH

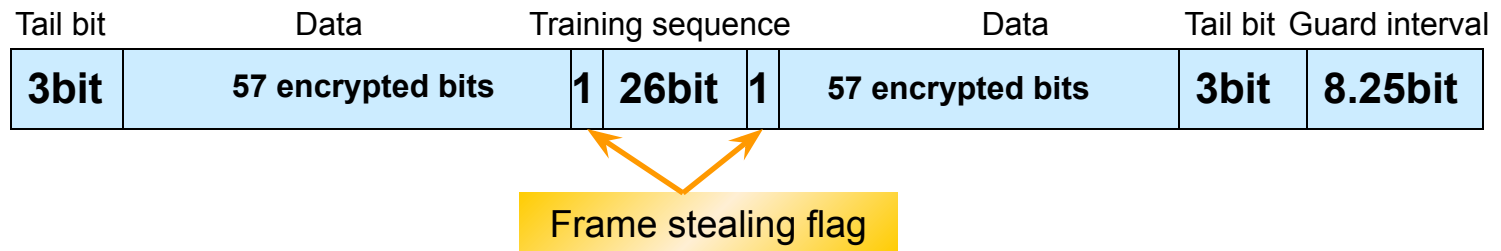

- Dummy burst (DB)
  - Used in transmission of filling frames by BTS at timeslots when there is no information delivered

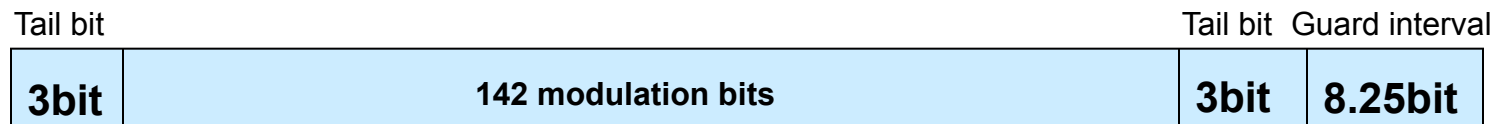

# Logical Channel Type

- GSM900 and DCS1800 have the same logical channel category

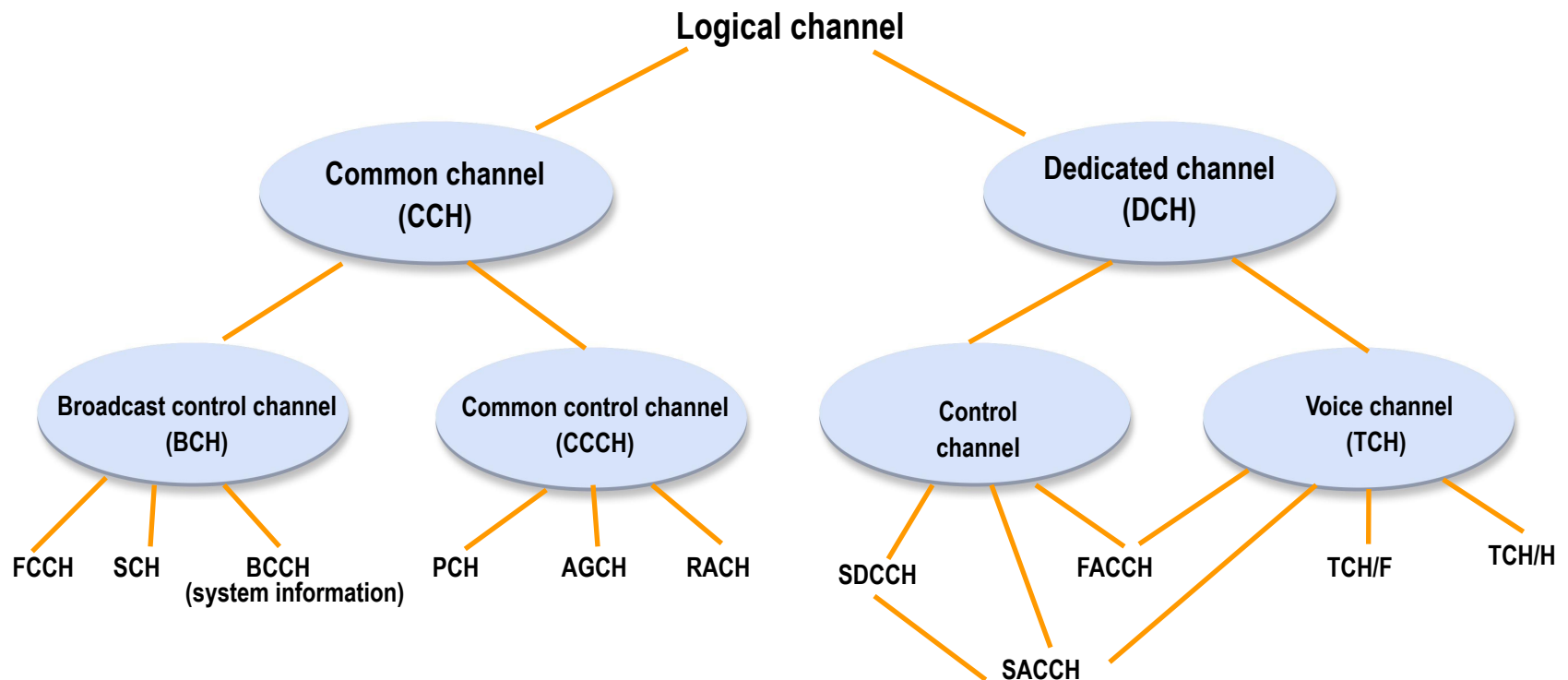

# Downlink Logical Channel

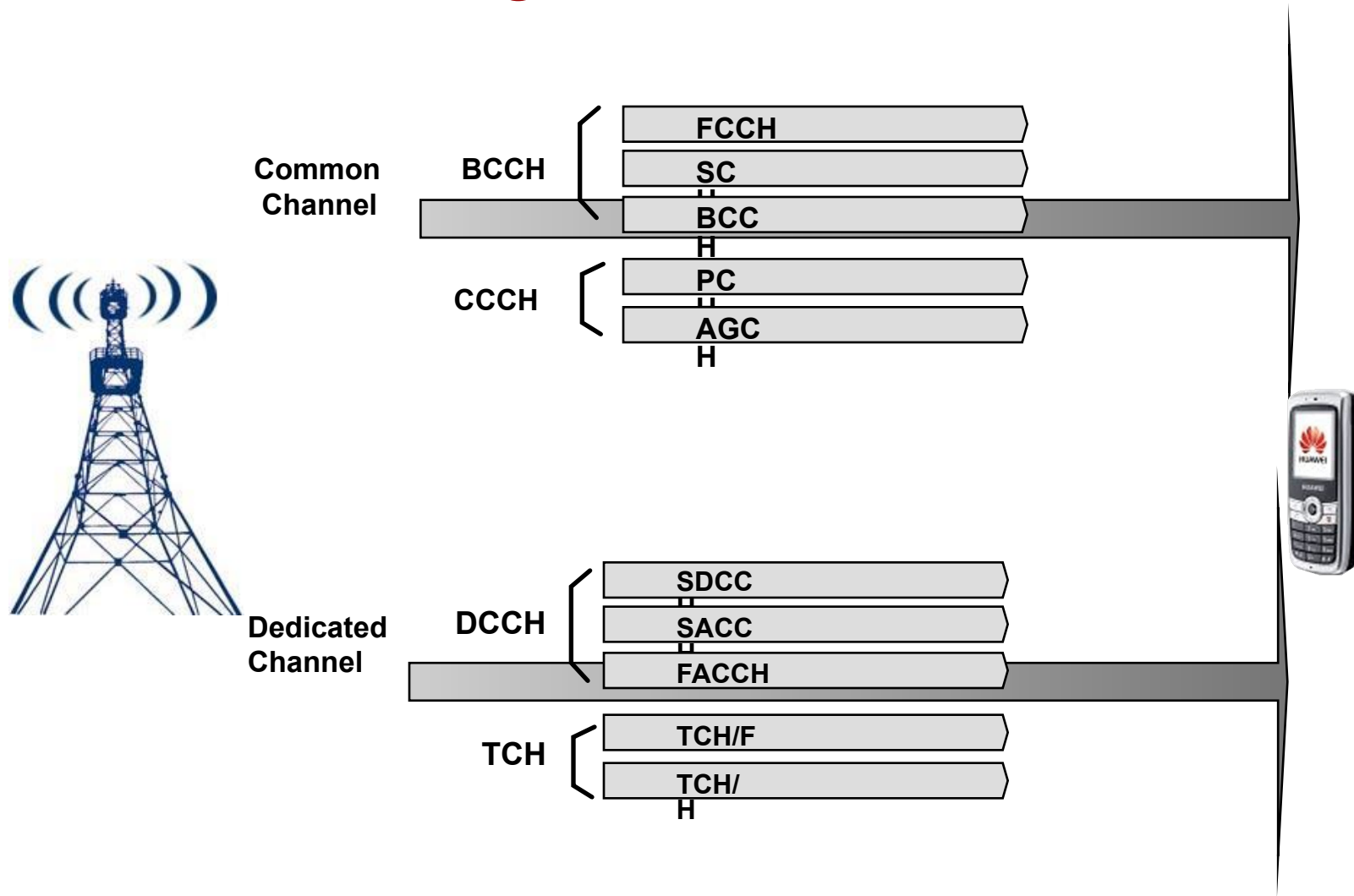

# Downlink Logical Channel

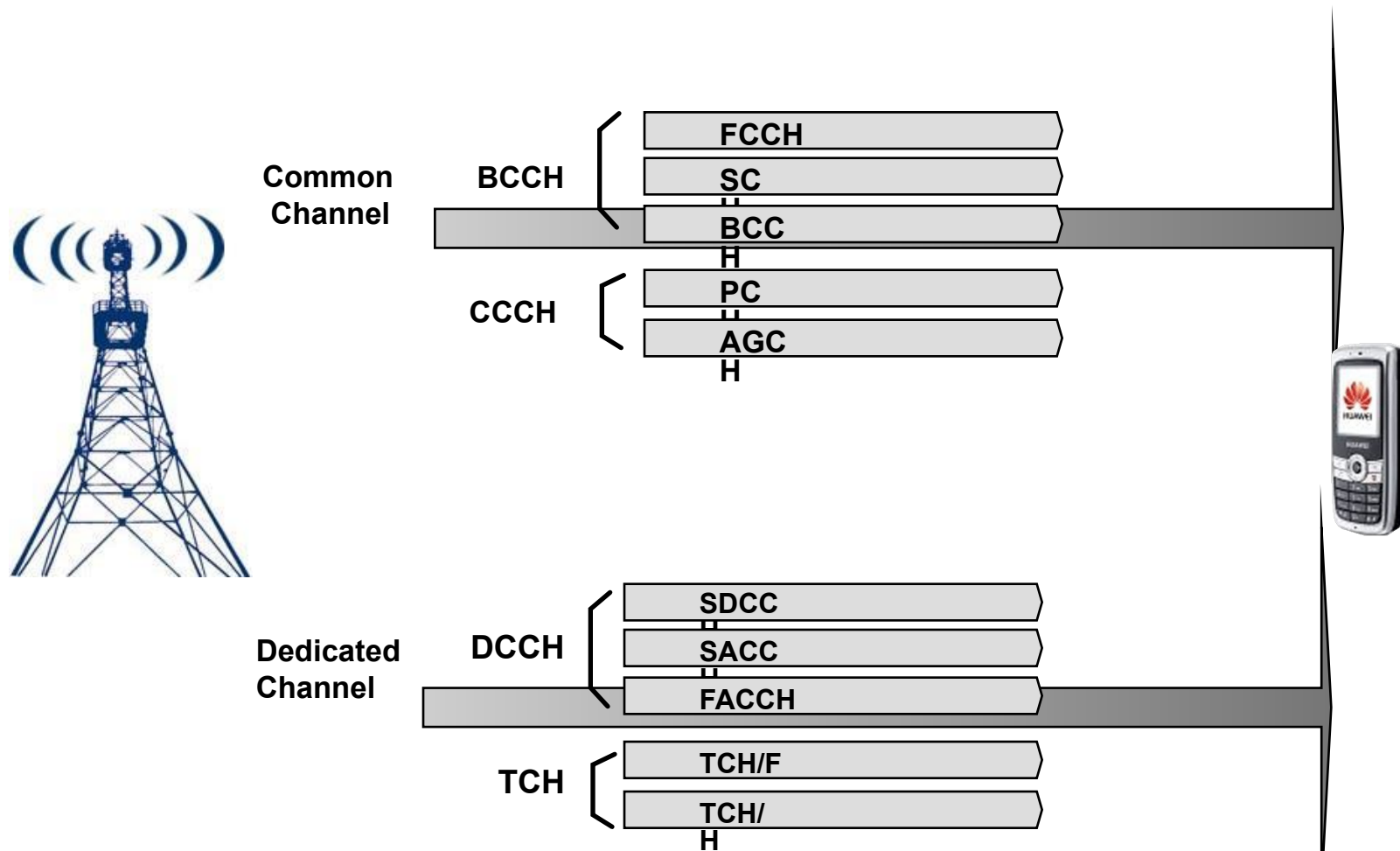

# Uplink Logical Channel

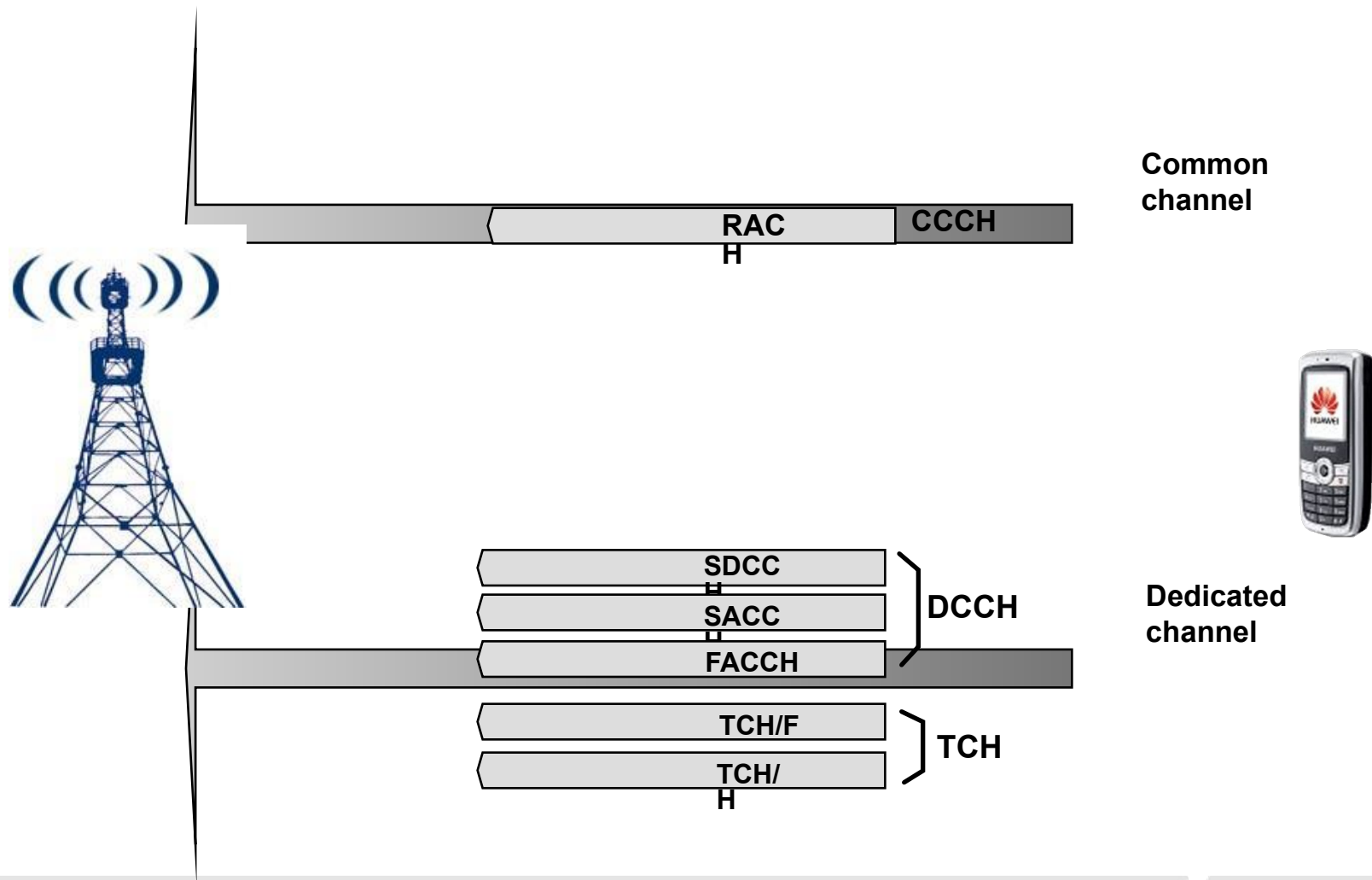

# Uplink Logical Channel

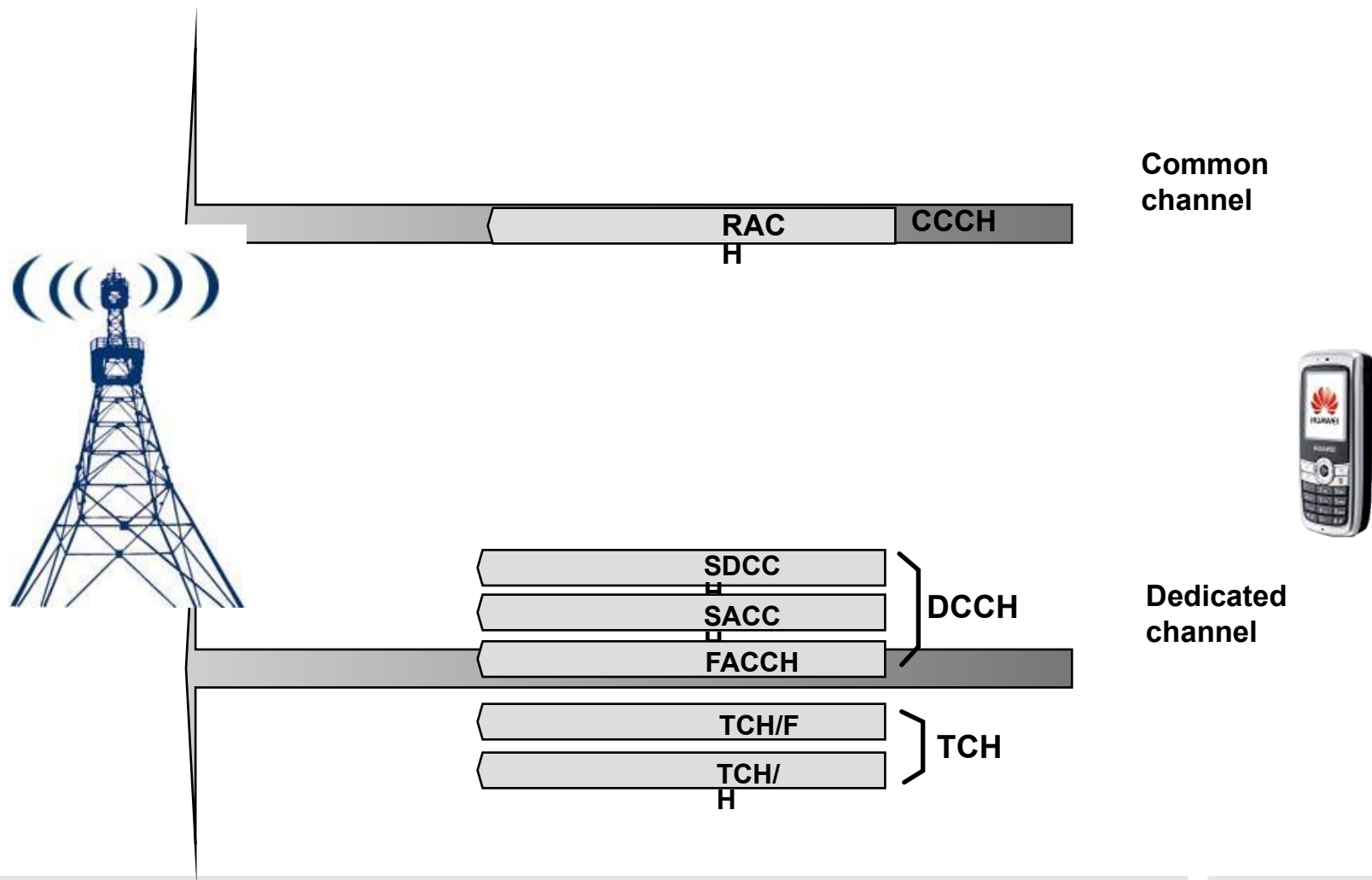



# Use of Logical Channels

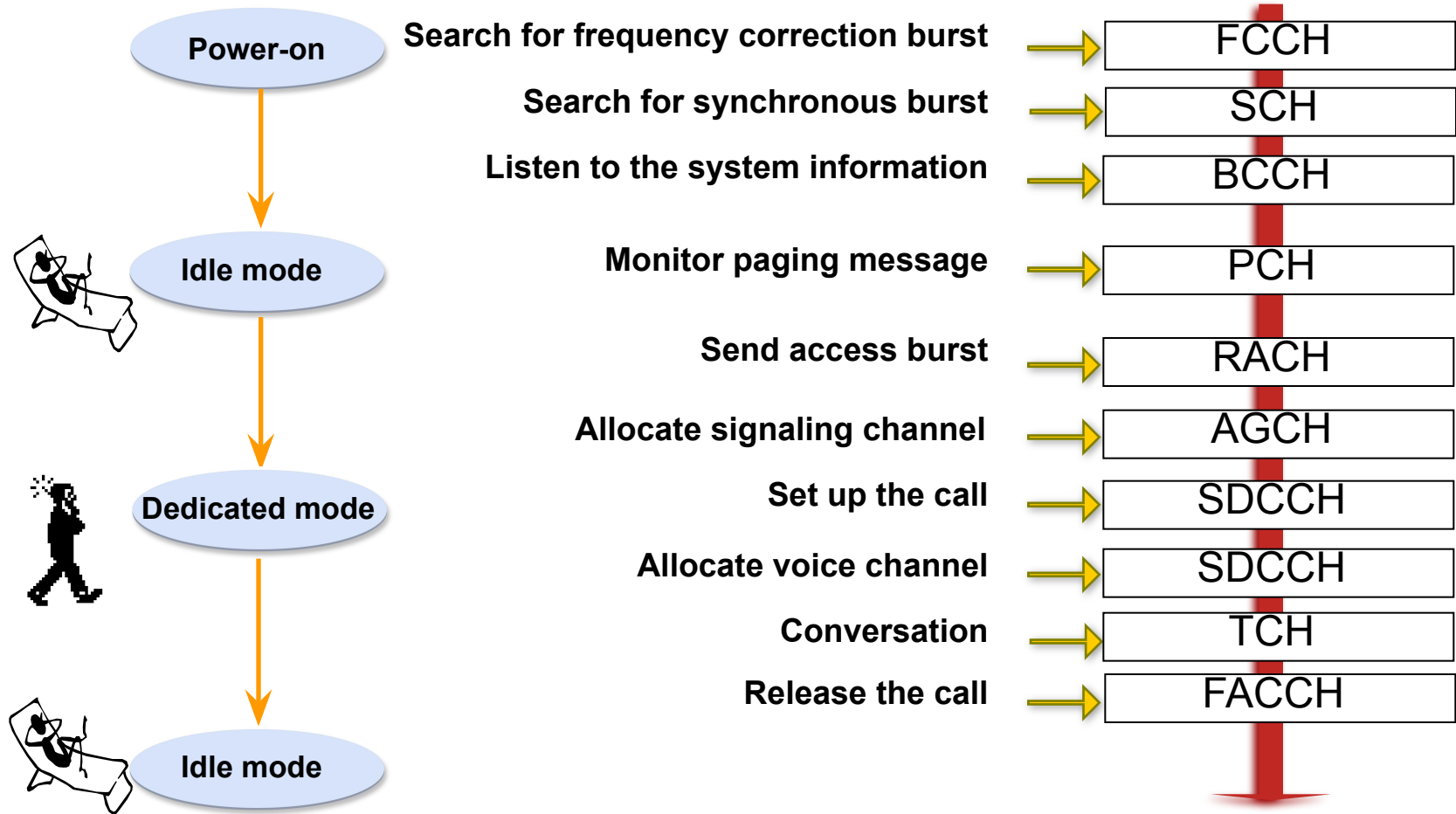

# Physical Combination of Logical Channel

## **26-frame multi-frame**

TCH/F+FACCH/F+SACCH/F (full-rate TCH)

TCH/H+FACCH/H+SACCH/H (half-rate TCH)

## **51-frames multi-frame**

FCCH+SCH+BCCH+CCCH (main BCCH)

FCCH+SCH+BCCH+CCCH+SDCCH/4+SACCH/4 (combined BCCH)

BCCH+CCCH (extended BCCH)

SDCCH/8+SACCH/8 (main SDCCH)

# Structure of Main BCCH

1 multi-frame (51TDMA Frames) 235.38ms Downlink																		
Group	Group1				Group2				Group3,4 (same as Group2)	Group5								
Channel	F	S	BX4	CX4	F	S	CX4	CX4	.....	F	S	CX4	CX4	I				
Frame Number	0	1	2-5	6-9	10	11	12-15	16-19	20-39	40	41	42-45	46-49	50				
1 multi-frame (51TDMA Frames) 235.38ms Uplink																		
Channel	R	R	R	R	R	R	R	R	R	R	R	R	R	R.....R	R	R	R	R
Frame Number	0	1	2	3	4	5	6	7	8	9	10	11	12	13-46	47	48	49	50

**F:FCCH; S:SCH; B:BCCH; C:CCCH; R:RACH; I:IDLE**

# Structure of Combined BCCH

1 multi-frame (51TDMA Frames) 235.38ms Downlink																					
Group	Group1				Group2				Group3				Group4				Group5				
Channel	F	S	B×4	C×4	F	S	C×4	C×4	F	S	D0×4	D1×4	F	S	D2×4	D3×4	F	S	A0×4	A1×4	I
Channel	F	S	B×4	C×4	F	S	C×4	C×4	F	S	D0×4	D1×4	F	S	D2×4	D3×4	F	S	A2×4	A3×4	I
Frame Number	0	1	2-5	6-9	10	11	12-15	16-19	20	21	22-25	26-29	30	31	32-35	36-39	40	41	42-45	46-49	50

1 multi-frame (51TDMA Frames) 235.38ms Uplink																		
Channel	D3×4		R	R	A2×4		A3×4		R.....R		D0×4	D1×4	R	R	D2×4			
Channel	D0×4		R	R	A0×4		A1×4		R.....R		D0×4	D1×4	R	R	D2×4			
Frame Number	0-3		4	5	6-9		10-13		14-36		37-40		41-44		45	46	47-50	

**F:FCCH; S:SCH; B:BCCH; C:CCCH; D:SDCCH ;A:SACCH; R:RACH; I:IDLE**

# Structure of Logical Channel Combination Frame-Main SDCCH

1 multi-frame (51TDMA Frames) 235.38ms Downlink															
Channel	D0× 4	D1× 4	D2× 4	D3× 4	D4× 4	D5× 4	D6× 4	D7× 4	A0× 4	A1× 4	A2× 4	A3× 4	I	I	I
Channel	D0× 4	D1× 4	D2× 4	D3× 4	D4× 4	D5× 4	D6× 4	D7× 4	A4× 4	A5× 4	A6× 4	A7× 4	I	I	I
Frame Number	0-3	4-7	8-11	12-1 5	16-1 9	20-2 3	24-2 7	28-3 1	32-3 5	36-3 9	40-4 3	44-4 7	48	49	50

1 multi-frame (51TDMA Frames) 235.38ms Uplink															
Channel	A5× 4	A6× 4	A7× 4	I	I	I	D0× 4	D1 ×4	D2× 4	D3× 4	D4× 4	D5× 4	D6× 4	D7× 4	A0× 4
Channel	A1× 4	A2× 4	A3× 4	I	I	I	D0× 4	D1 ×4	D2× 4	D3× 4	D4× 4	D5× 4	D6× 4	D7× 4	A4× 4
Frame Number	0-3	4-7	8-11	12	13	14	15-1 8	19- 22	23-2 6	27-3 0	31-3 4	35-3 8	39-4 2	43-4 6	47-5 0

**D:SDCCH; A:SACCH; I:IDLE**

# Structure of Logical Channel Combination Frame-TCH

## Case of one full rate TCH

1 multi-frame (26TDMA Frames) 120ms

Channel	T	T	T	T	T	T	T...T	A	T,,,T	T	T	T	T	T	T	I
Frame Number	0	1	2	3	4	5	6...11	12	13...18	19	20	21	22	23	24	25

## Case of two half rate TCHs

1 multi-frame (26TDMA Frames) 120ms

Channel	T	t	T	t	T	t	T...t	A	T,,,t	T	t	T	t	T	t	a
Frame Number	0	1	2	3	4	5	6...11	12	13...18	19	20	21	22	23	24	25

**T:TCH;A:SACCH; I:IDLE**

# Frame

1 hyper frame=2048 super-frames=2715648 TDMA frames (3 hours, 28 minutes, 53 seconds and 760 milliseconds)

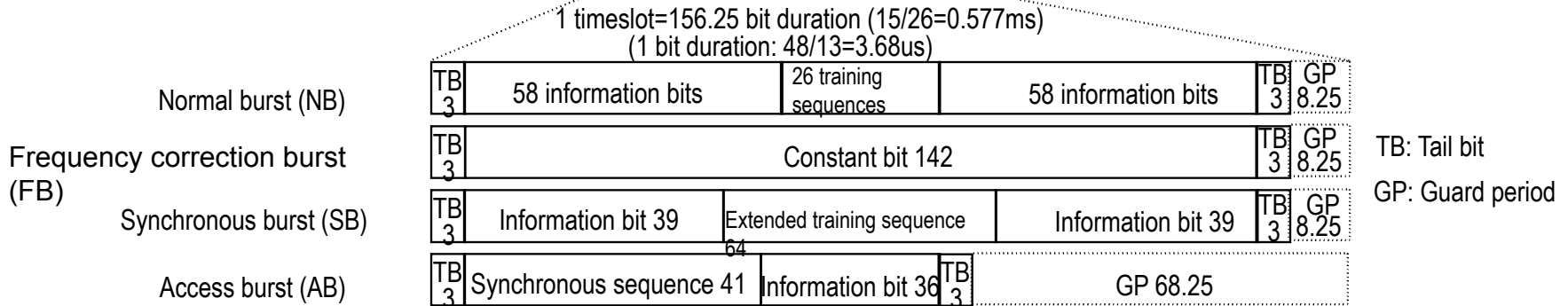
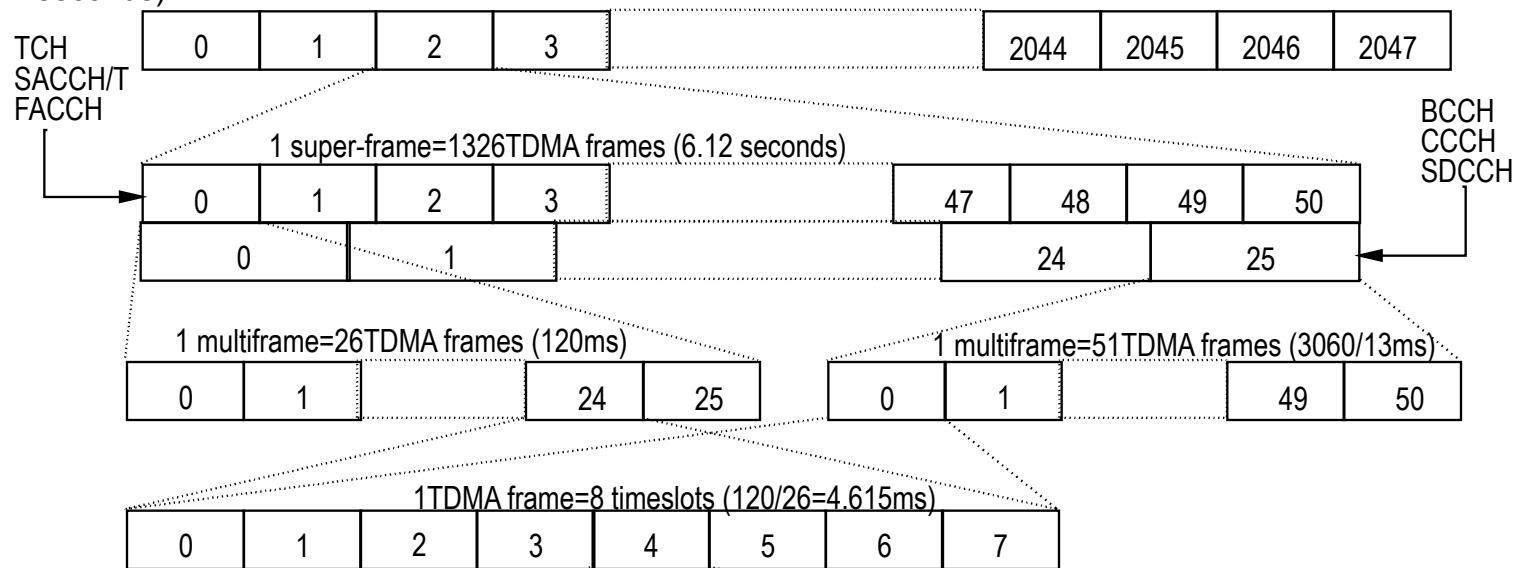

# Frame

1 hyper frame=2048 super-frames=2715648 TDMA frames (3 hours, 28 minutes, 53 seconds and 760 milliseconds)

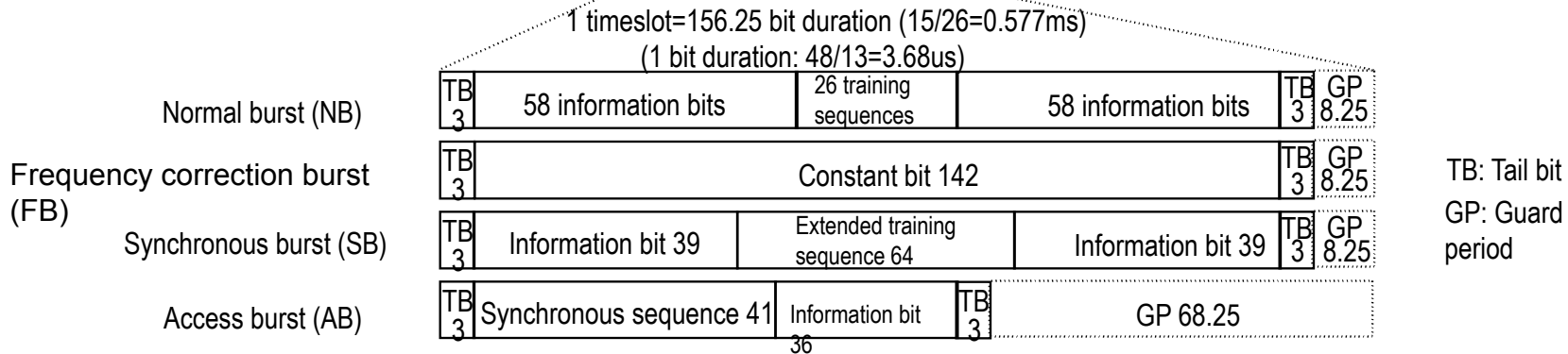
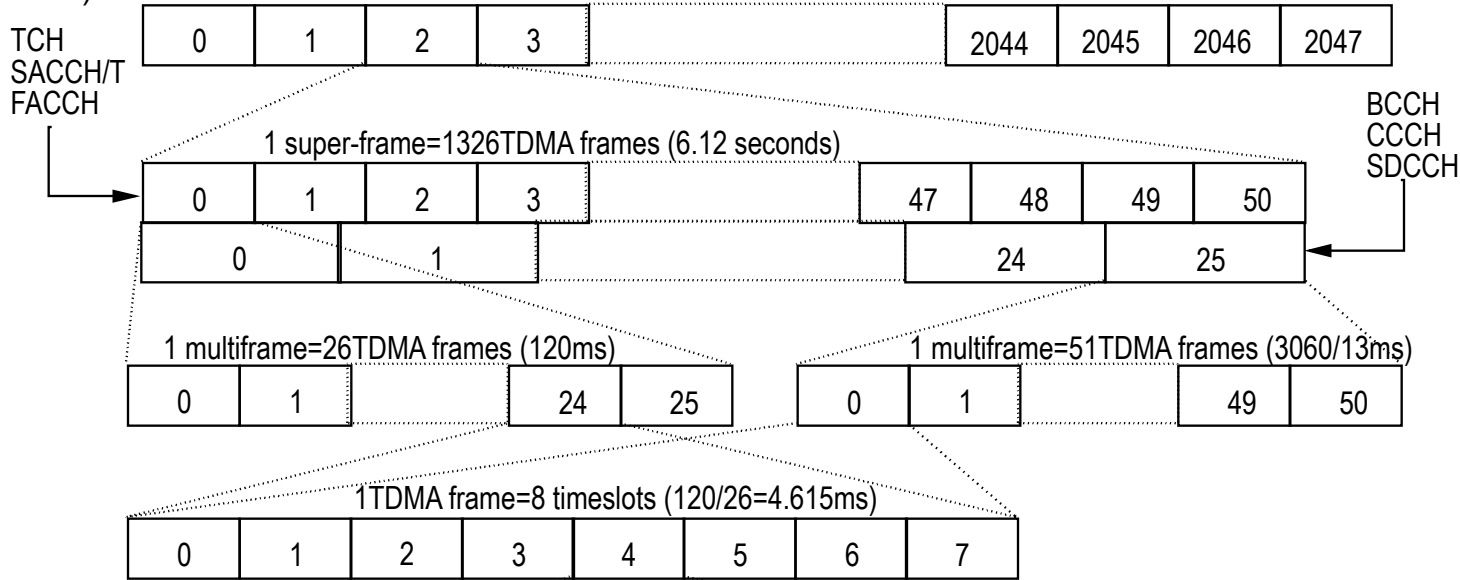



# Configuration of Common Control Channel

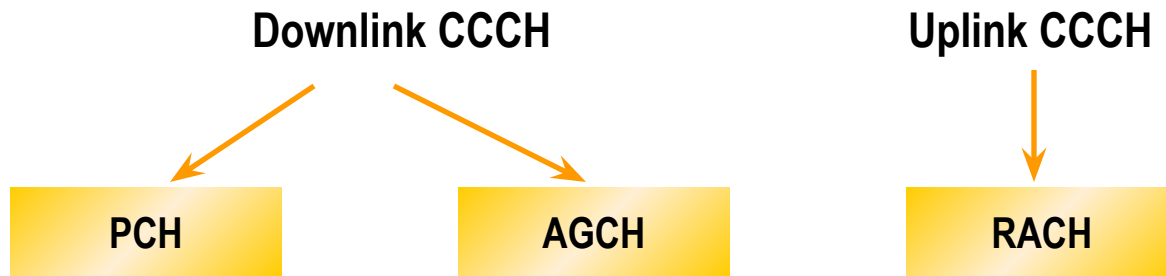

**How to determine the total CCCH resources of the cell? How to allocate AGCH and PCH reasonably?**



# Summary

- In this course, we have learned:
  - Processing of Voice Signal
  - Radio Channel in Um Interface
  - Key Technical in Um Interface

Thank

[www.huawei.com](http://www.huawei.com)  
you