

Crystal defects

Perfect Crystals

- All atoms are at rest on their correct lattice position.
- Hypothetically, only at zero Kelvin.
- $S=0$

$$S = k \ln W$$

- $W=1$, only one possible arrangement to have all N atoms exactly on their lattice points.
- Vibration of atoms can be regarded as a form of defects.

Classification of defects in solids

- **Zero-dimensional (point) defects**

Vacancies, Interstitial atoms (ions), Foreign atoms (ions)

- **One-dimensional (linear) defects**

Edge dislocation, screw dislocation

- **Two-dimensional (flat) defects**

Antiphase boundary, shear plane, low angle twist boundary, low angle tilt boundary, grain boundary, surface

- **Three-dimensional (spatial) defects**

Pores, foreign inclusions

Thermodynamics of defect formation

Perfect → imperfect

n vacancies created

$$\Delta G = G_{\text{def}} - G_{\text{per}} = \Delta H - T\Delta S$$
$$\Delta H = n \Delta H_i$$

ΔH_i : enthalpy of formation of one vacant site

$$\Delta S = \Delta S_{\text{osc}} + \Delta S_c$$

ΔS_{osc} : change of oscillation entropy of atoms surrounding the vacancy

ΔS_c : change in configurational entropy of system on vacancies formation

$$\Delta S_c = S_{c(def)} - S_{c(id)}$$

$$\Delta S_c = k \ln W_{def} - k \ln W_{id} = k \ln \frac{W_{def}}{W_{id}}$$

$$\Delta S_c = k \ln W_{def}$$

Now, N atoms distributed over N+n sites
And n vacancies distributed over N+n sites

$$\Delta S_c = -k \left[N \ln \frac{N}{N+n} + n \ln \frac{n}{N+n} \right]$$

$$\Delta G = n\Delta H - nT\Delta S_{osc} + kT \left[N \ln \frac{N}{N+n} + n \ln \frac{n}{N+n} \right]$$

ΔH always positive

ΔS_{osc} always negative

$n/(N+n) < 1, \ln < 0$

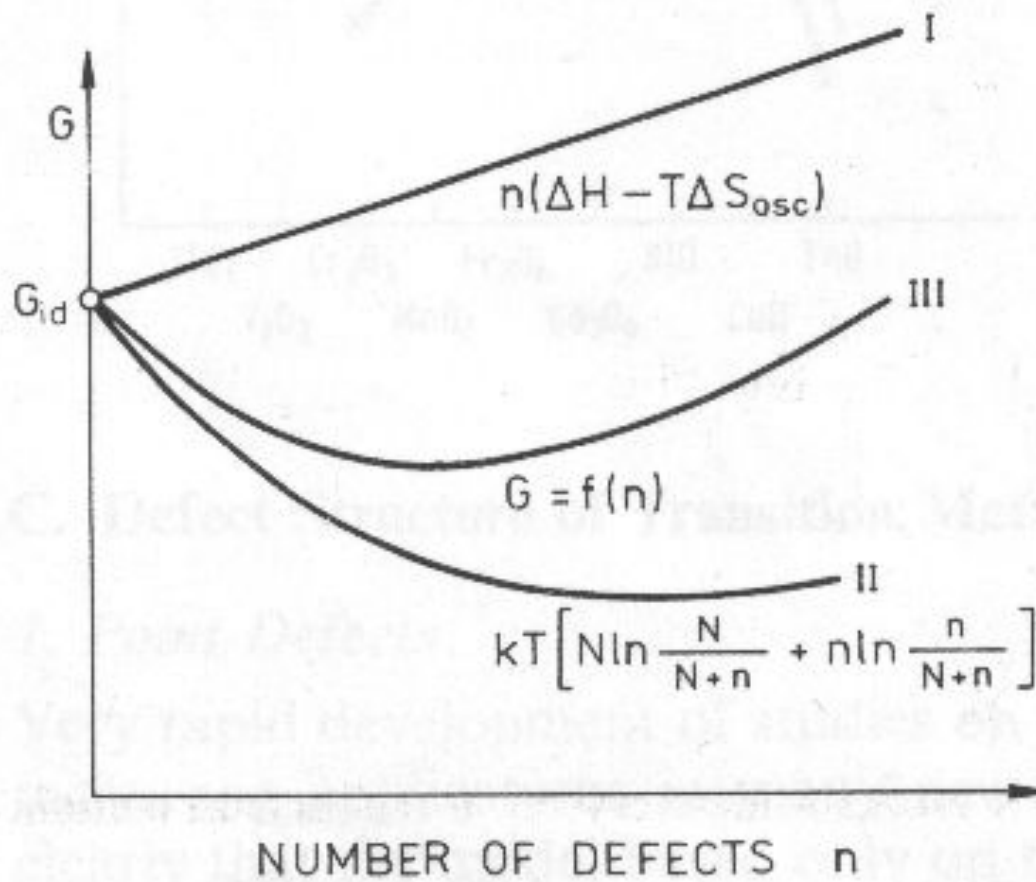

$$\frac{\partial G}{\partial n} = 0$$

$$\frac{n}{N-n} = x_n \approx \exp\left(\frac{\Delta S_{osc}}{k}\right) \exp\left(-\frac{\Delta H}{kT}\right)$$

- ***Defect formation possible only due to increased configurational entropy in that process.***
- ***After n exceeds a certain limit, no significant increase in S_c is produced***

Crystal Defects

Defects can affect

- Strength
- Conductivity
- Deformation style
- Color

Schottky defects

- Vacancies carry an effective charge
- Oppositely charged vacancies are attracted to each other in form of pairs

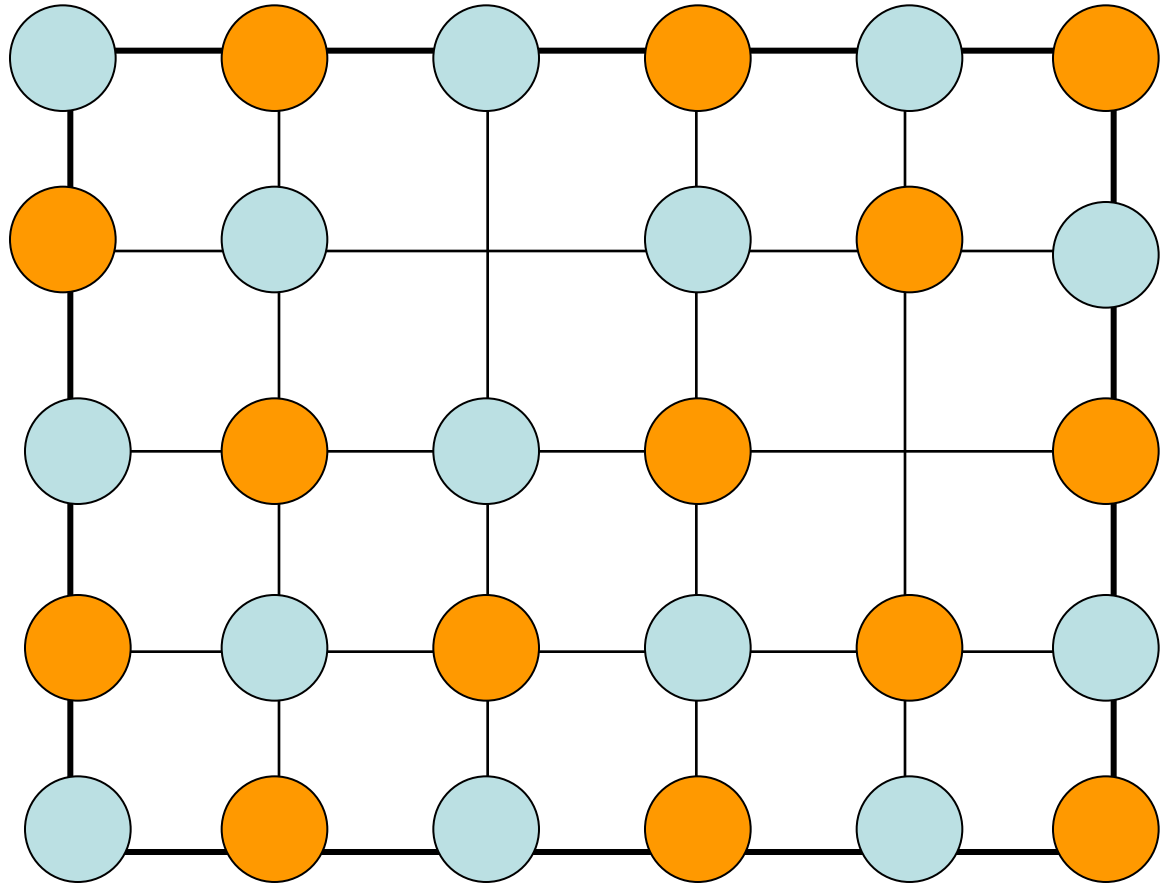

$$0 \square V_M + V_X$$

Stoichiometric defect, electroneutrality conserved

NaCl

- **Dissociation enthalpy for vacancies pairs ≈ 120 kJ/mol.**
- **At room temperature, 1 of 10^{15} crystal positions are vacant.**
- **Corresponds to 10000 Schottky defect in 1 mg.**
- **These are responsible for electrical and optical properties of NaCl.**

Frenkel defects

Oppositely charged vacancies and interstitial sites are attracted to each other in form of pairs.

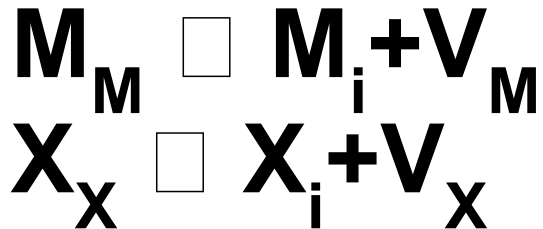
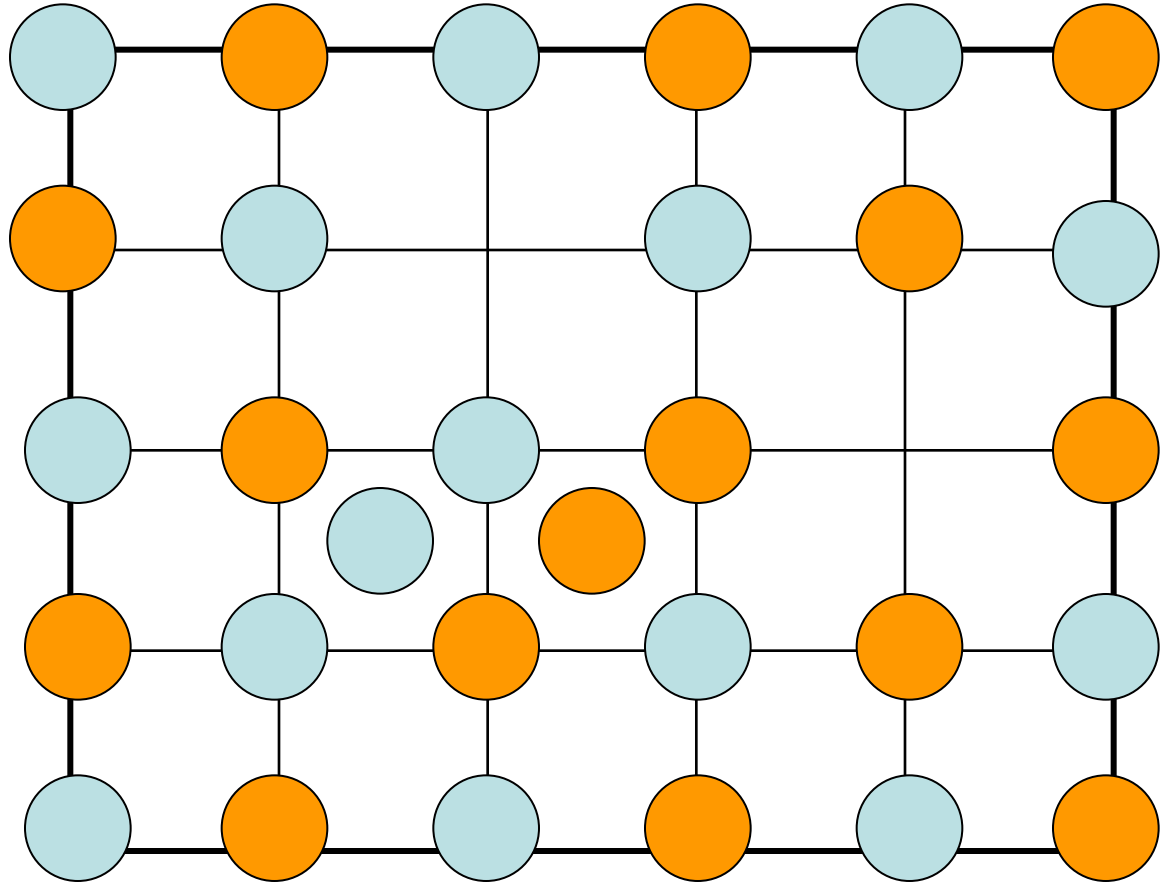

Stoichiometric defect

AgCl

- Ag^+ in interstitial sites.
- $(\text{Ag}^+)_i$ tetrahedrally surrounded by 4 Cl^- and 4 Ag^+ .
- Some covalent interaction between $(\text{Ag}^+)_i$ and Cl^- (further stabilization of Frenkel defects).
- Na^+ harder, no covalent interaction with Cl^- . Frenkel defects don't occur in NaCl .
- CaF_2 , ZrO_2 (Fluorite structure): anion in interstitial sites.
- Na_2O (anti fluorite): cation in interstitial sites.

Crystal Defects

Line Defects .2

d) Edge dislocation

Migration aids ductile deformation

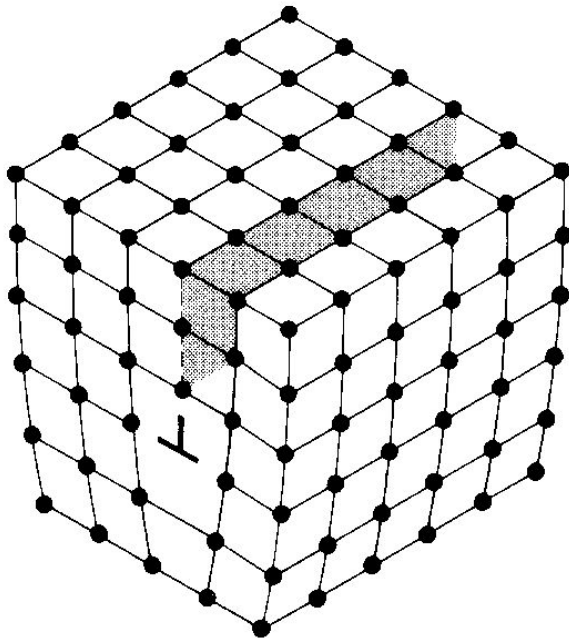

(d) Edge dislocation

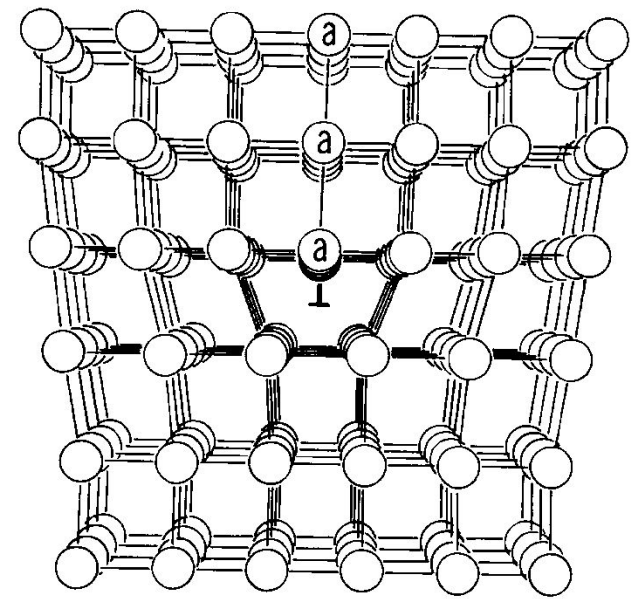

A

Fig 10-4 of
Bloss,
Crystallography
and Crystal
Chemistry. ©
MSA

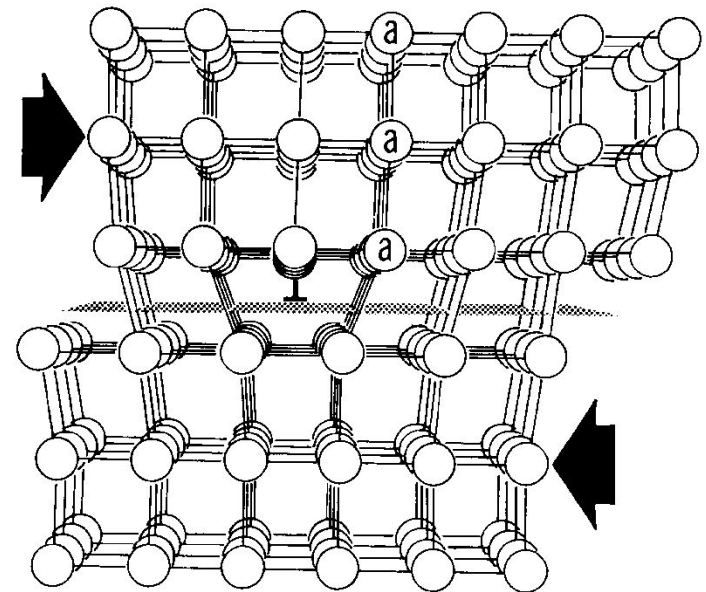

B

Crystal Defects

Line Defects .2

e) Screw dislocation (aids mineral growth)

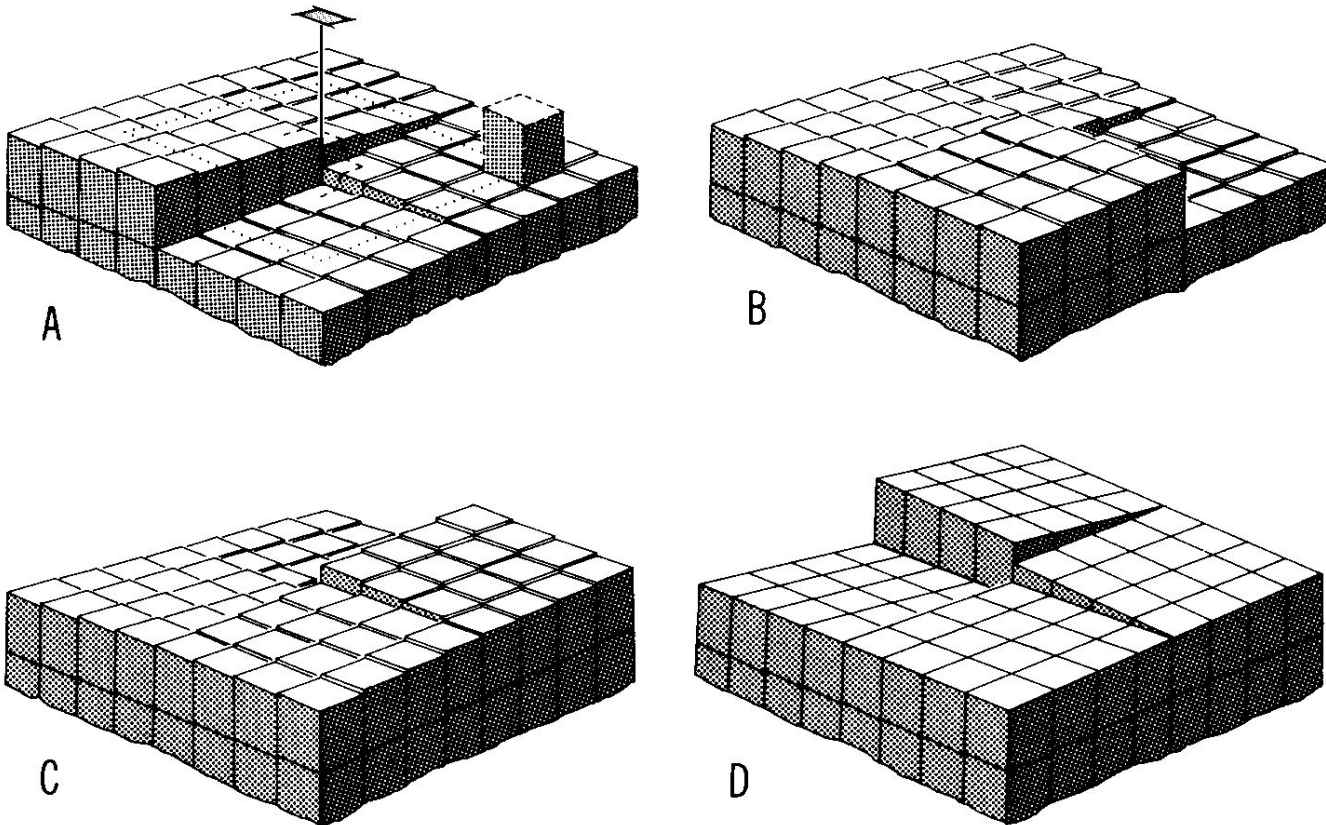

Fig 10-5 of
Bloss,
Crystallography
and Crystal
Chemistry. ©
MSA

Crystal Defects

Plane Defects .3

f) Lineage structure or mosaic crystal

Boundary of slightly mis-oriented volumes within a single crystal

Lattices are close enough to provide continuity (so not separate crystals)

Has short-range order, but not long-range (V_4)

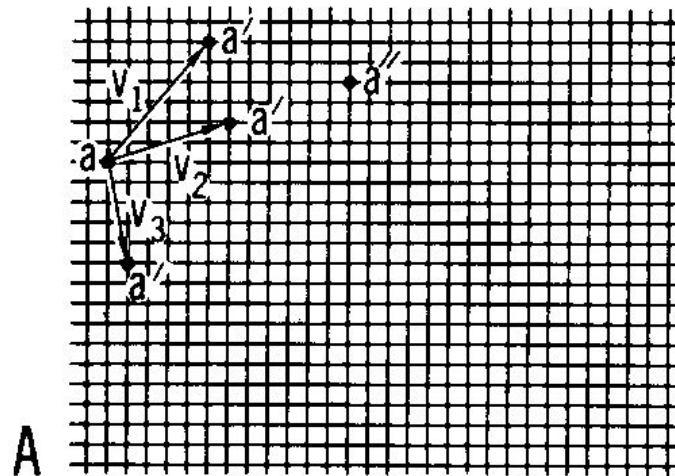

LATTICE : IDEAL CRYSTAL

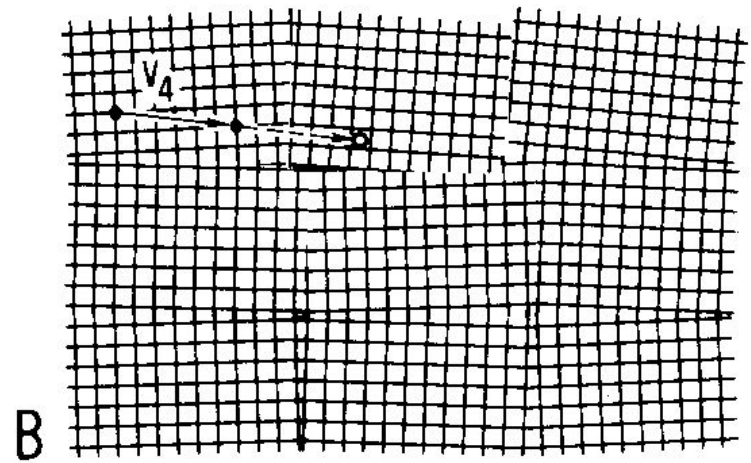

LATTICE : MOSAIC CRYSTAL

Crystal Defects

Plane Defects .3

g) Domain structure (antiphase domains)

Also has short-range but not long-range order

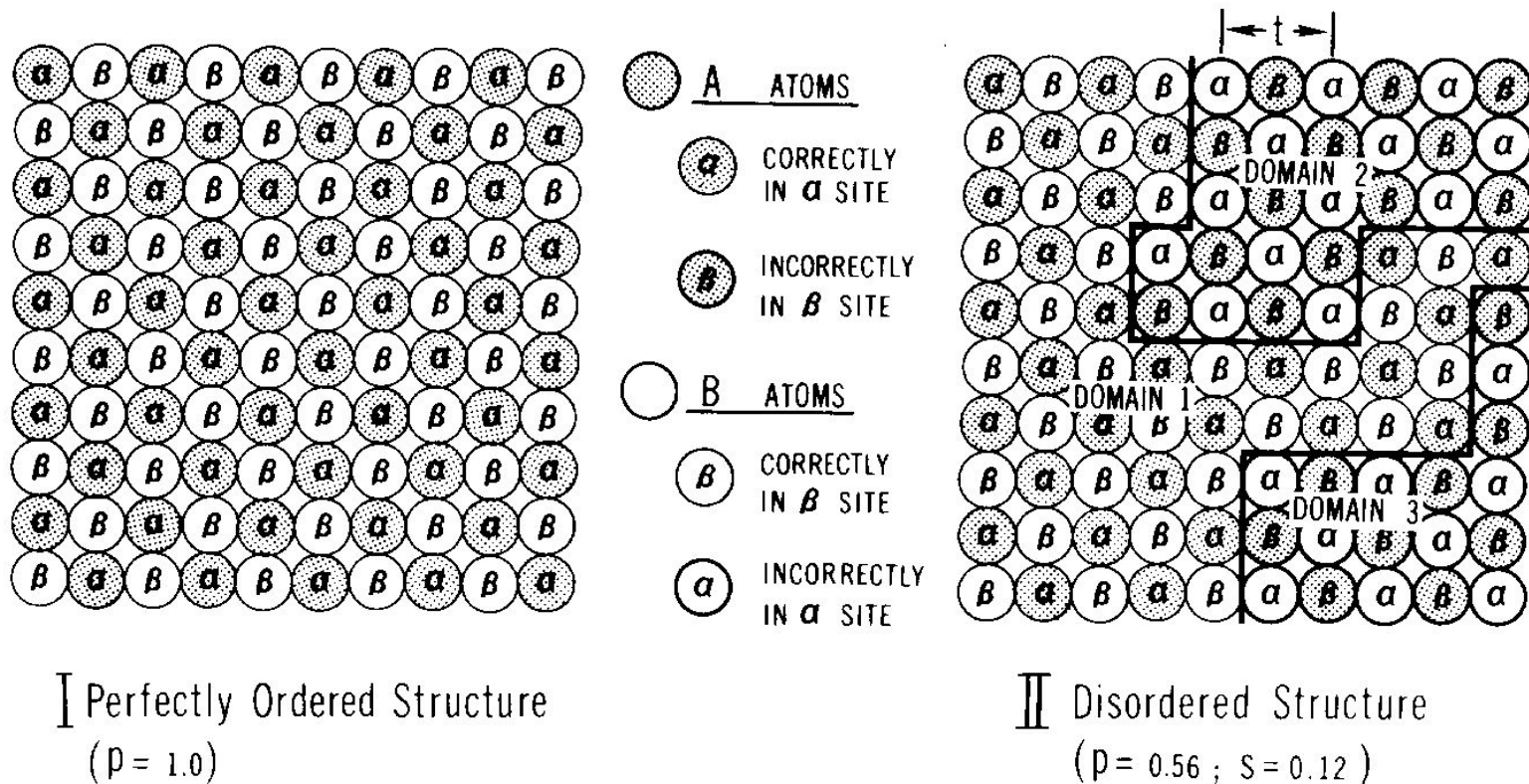

Fig 10-2 of Bloss, Crystallography and Crystal Chemistry. © MSA

Crystal Defects

Plane Defects .3

h) Stacking faults

Common in clays and low-T disequilibrium

A - B - C layers may be various clay types (illite, smectite, etc.)

ABCABCABC**ABAB**CABC

AAAAAA**B**AAAAAAA

ABABABABAB**C**ABABAB

Color centres

F-centres

- NaCl exposed to Na vapor.
- Absorbed Na ionized.
- Electron diffuses into crystal and occupies an anionic vacancy.
- Equal number of Cl⁻ move outwards to the surface.
- Classical example of particle in a box.

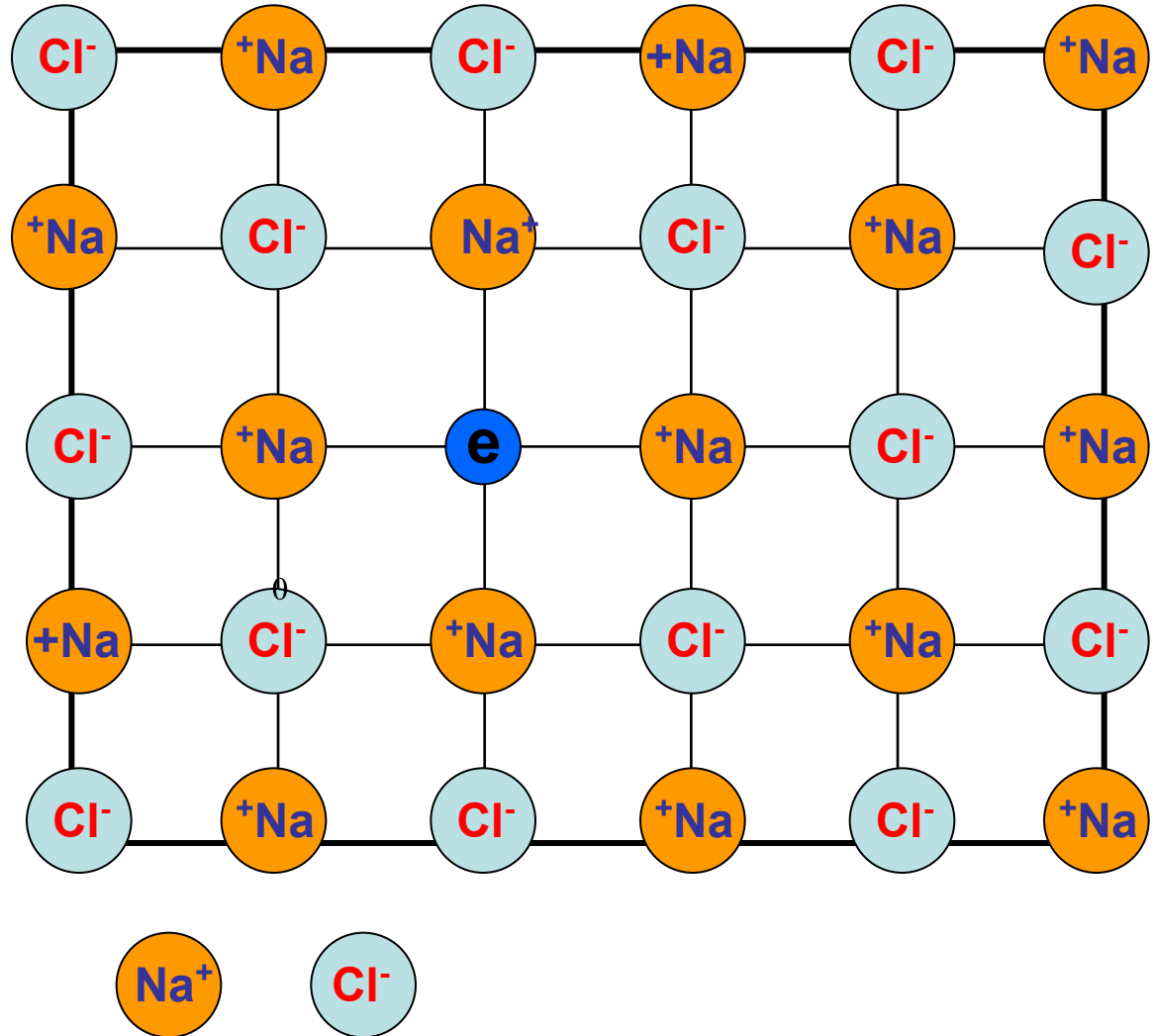

Nonstoichiometric
greenish yellow

- **Color depends on host crystal not on nature of vapor.**

K vapors would produce the same color.

- **Color centres can be investigated by ESR.**

- **Radiation with X-rays produce also color centres.**

Due to ionization of Cl^- .

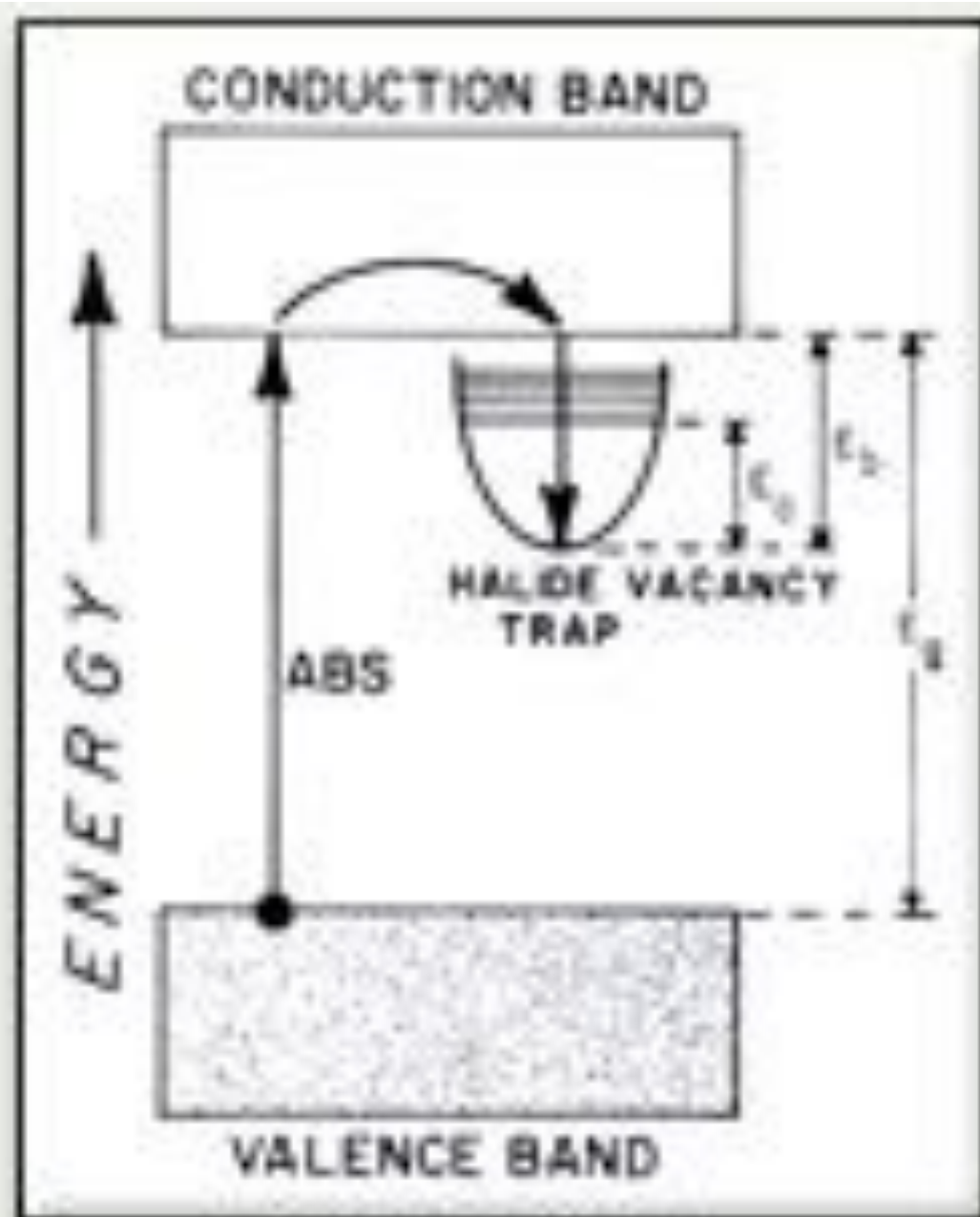

H-centres

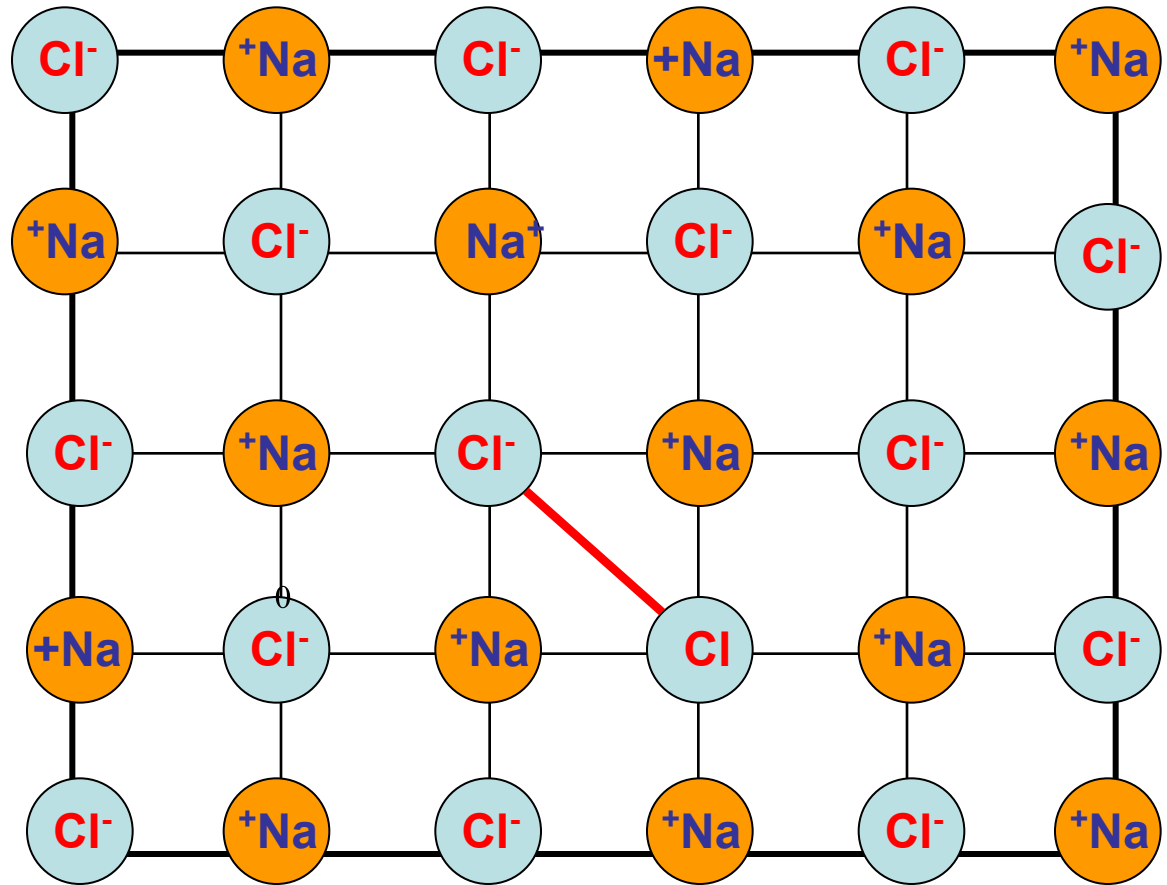

- Cl₂⁻ ion parallel to the [101] direction
- Covalent bond between Cl and Cl

V-centres

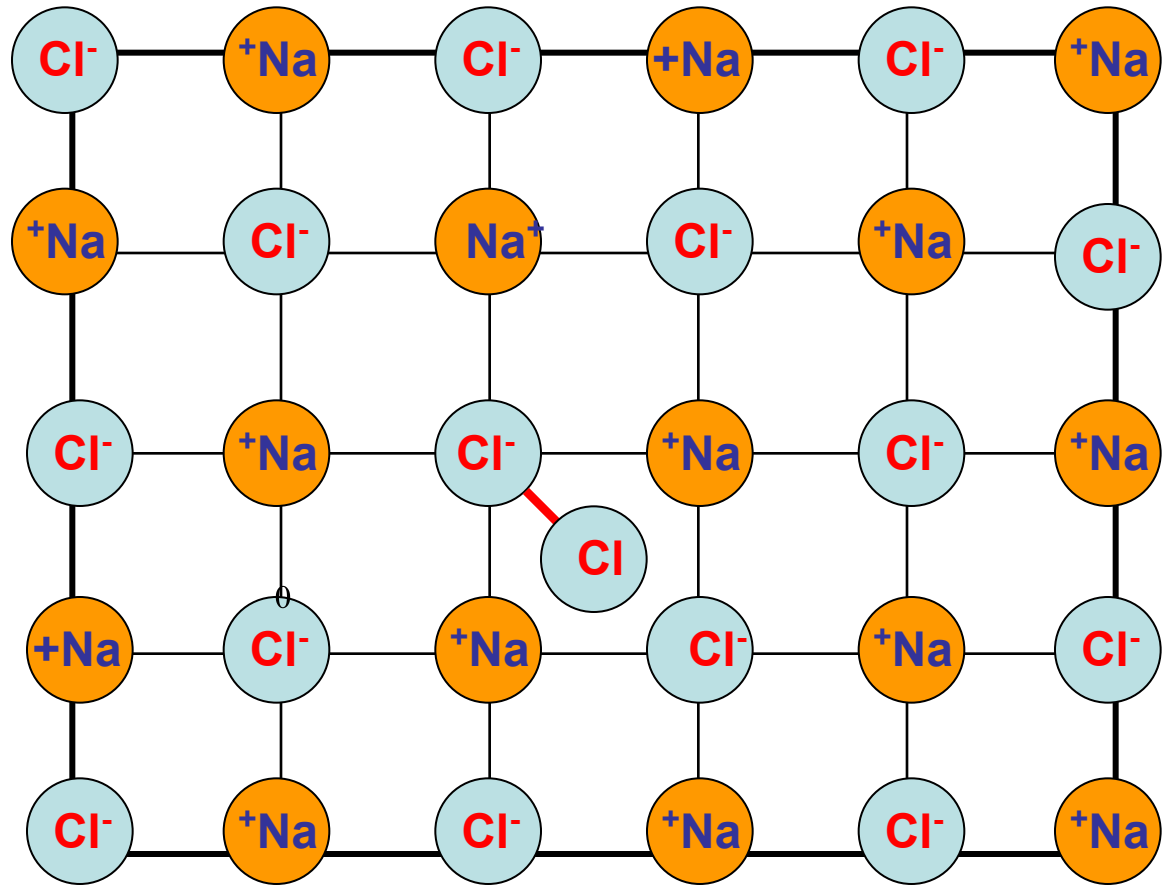

- Cl₂⁻ ion parallel to the [101] direction
- Covalent bond between Cl and Cl

Different types of color centres

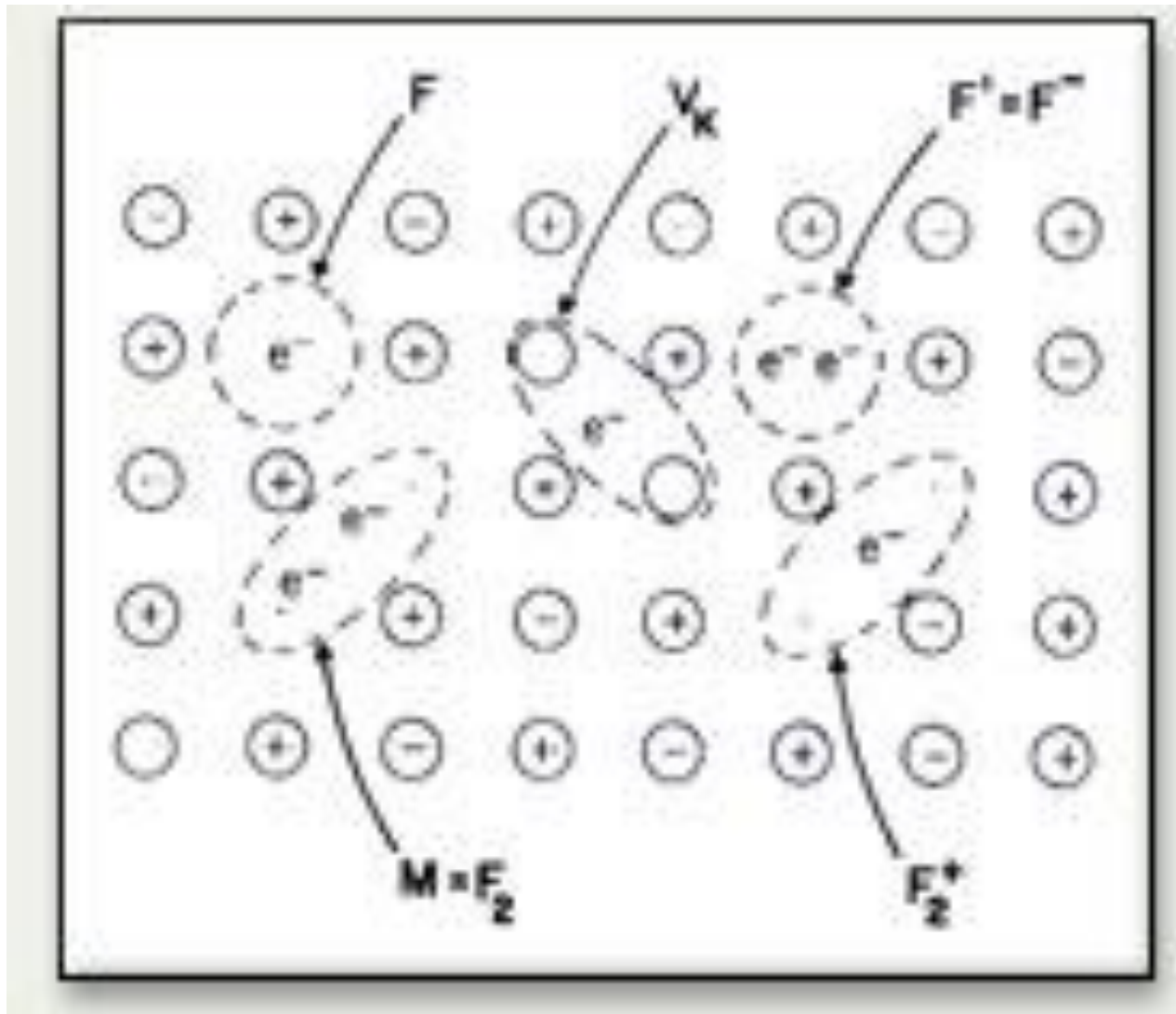

Colors in the solid state

Electromagnetic Radiation and the Visible Spectrum

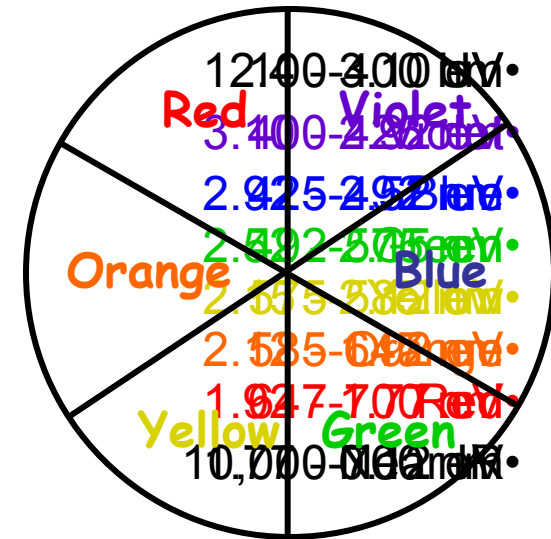

If **absorbance** occurs in one region of the color wheel the material appears with the opposite (**complimentary color**). For example

a material absorbs violet light → Color = Yellow –

a material absorbs green light → Color = Red –

a material absorbs violet, blue & green → Color = Orange-Red –

a material absorbs red, orange & yellow → Color = Blue –

$$E = hc/\lambda = \{(4.1357 \times 10^{-15} \text{ eV}\cdot\text{s})(2.998 \times 10^8 \text{ m/s})\}/\lambda$$

$$E \text{ (eV)} = 1240/\lambda(\text{nm})$$

Color in Extended Inorganic Solids: absorption

Intra-tomic (Localized) excitations •

- Cr³⁺ Gemstones (i.e. Cr³⁺ in Ruby and Emerald) –
- Blue and Green Cu²⁺ compounds (i.e. malachite, turquoise) –
- Blue Co²⁺ compounds (i.e. Al₂CoO₄, azurite) –

Charge-transfer excitations (metal-metal, anion-metal) •

- Fe²⁺ → Ti⁴⁺ in sapphire –
- Fe²⁺ → Fe³⁺ in Prussian Blue –
- O²⁻ → Cr⁶⁺ in BaCrO₄ –

Valence to Conduction Band Transitions in Semiconductors •

- WO₃ (Yellow) –
- CdS (Yellow) & CdSe –
- HgS (Cinnabar - Red)/ HgS (metacinnabar - Black) –

Intraband excitations in Metals •

- Strong absorption within a partially filled band leads to metallic –
lustre or black coloration
- Most of the absorbed radiation is re-emitted from surface in the –
form of
visible light □ high reflectivity (0.90-0.95)

Gemstones

Gem-stone	Color	Host crystal	Impurity
Ruby	Red	Aluminum oxide (Corundum)	Chromium
Emerald	Green	Beryllium aluminosilicate (Beryl)	Chromium
Garnet	Red	Calcium aluminosilicate	Iron
Topaz	Yellow	Aluminum fluorosilicate	Iron
Tourmaline	Pink-red	Calcium lithium boroaluminosilicate	Manganese
Turquoise	Blue-green	Copper phosphoaluminate	Copper

Cr³⁺ Gemstones

Excitation of an electron from one **d-orbital** to another **d-orbital** on the same atom often gives rise to absorption in the visible region of the spectrum. The Cr³⁺ ion in octahedral coordination is a very interesting example of this. Slight changes in its environment lead to changes in the splitting of the t_{2g} and e_g orbitals, which changes the color the material. Hence, Cr³⁺ impurities are important in a .number of gemstones

	Ruby	Alexandrite	Emerald
Host	Corundum Al₂O₃	Chrysoberyl BeAl₂O₄	Beryl Be₃Al₂Si₆O₁₈
$t_{2g}-e_g$ Splitting	2.23 eV	2.17 eV	2.05 eV
Color	Red	Blue-Green	Green



Red ruby. The name ruby comes from the Latin "Rubrum" meaning red. The ruby is in the Corundum group, along with the sapphire. The brightest red and thus most valuable rubies are usually from Burma. Violet

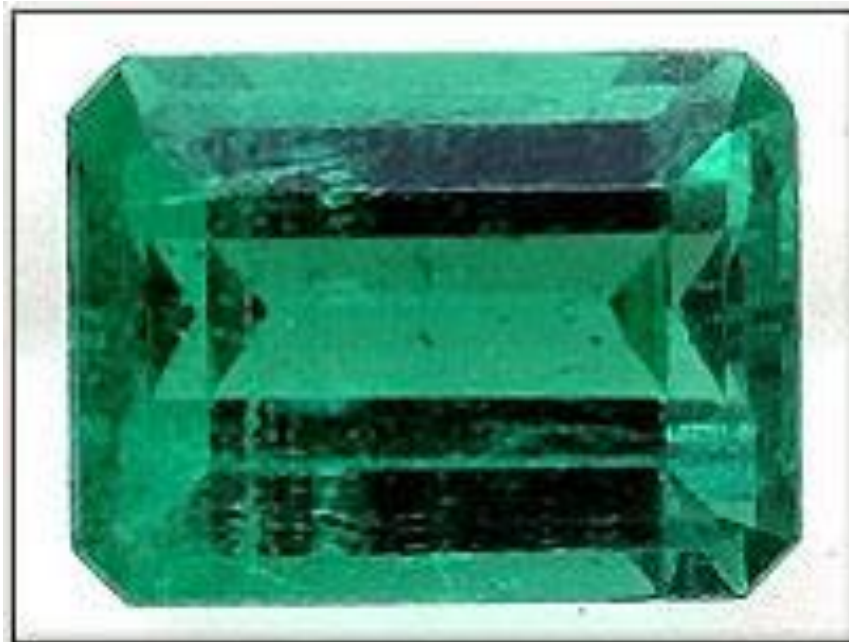

Green emerald. The mineral is transparent emerald, the green variety of Beryl on calcite matrix. 2.5 x 2.5 cm.
.Coscuez, Boyacá, Colombia

⁺Tunabe-Sugano Diagram Cr³⁺

The Tunabe-Sugano diagram below shows the allowed electronic excitations for Cr³⁺ in an octahedral crystal field (${}^4A_2 \rightarrow {}^4T_1$ & ${}^4A_2 \rightarrow {}^4T_2$). The dotted vertical line shows the strength of the crystal field splitting for Cr³⁺ in Al₂O₃. The ${}^4A_2 \rightarrow {}^4T_1$ energy difference corresponds to the splitting between t_{2g} and e_g.

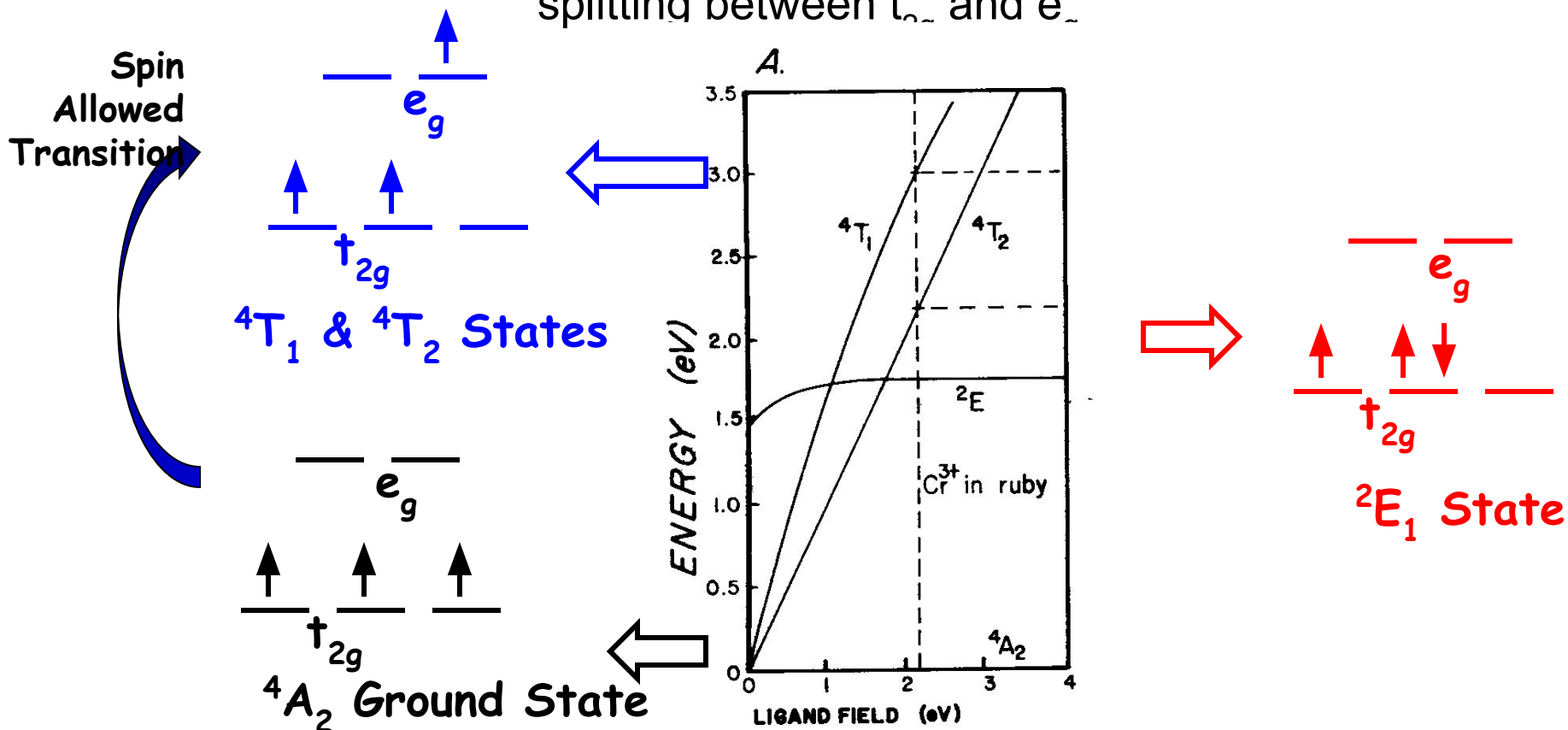

Ruby Red

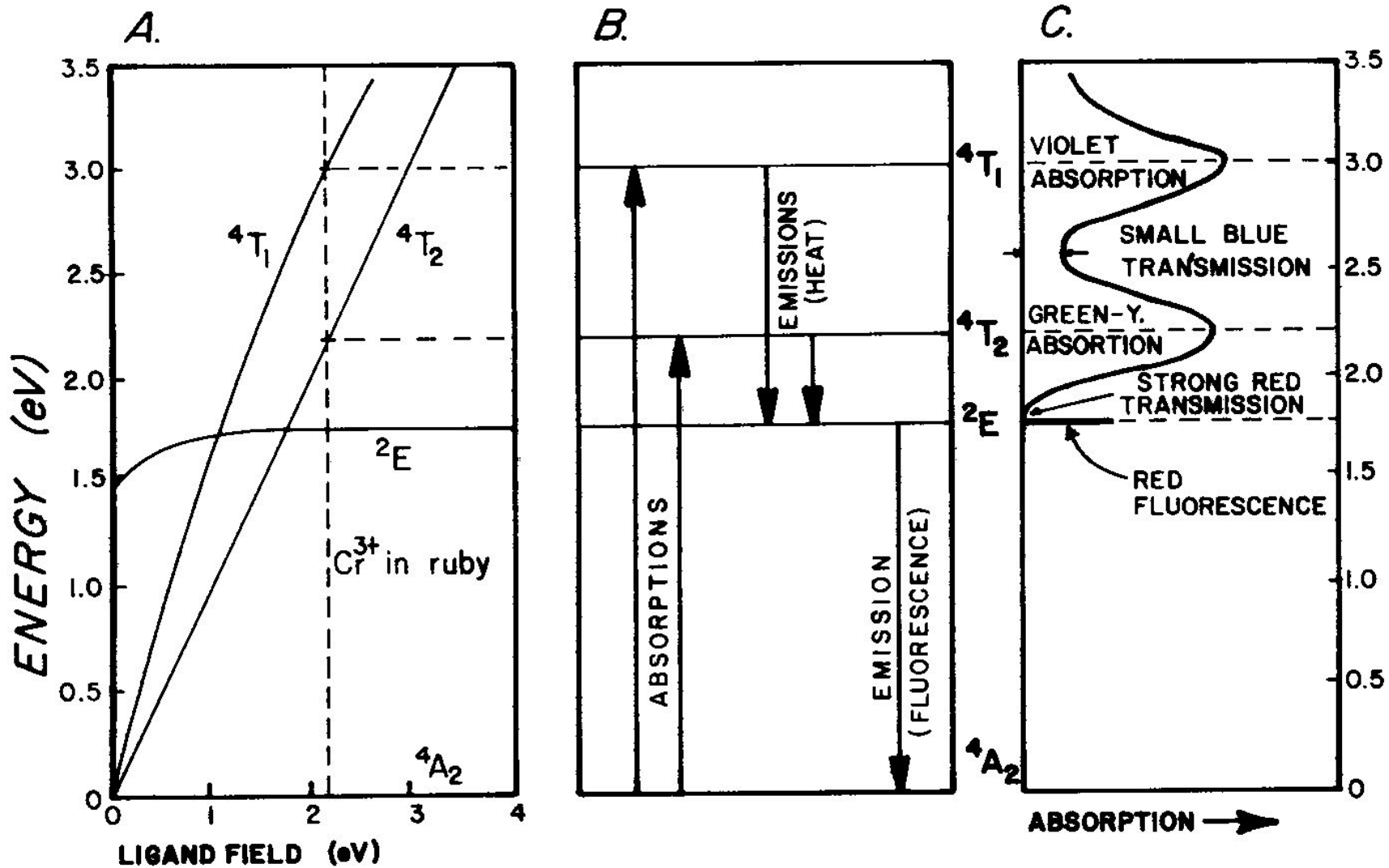

Emerald Green

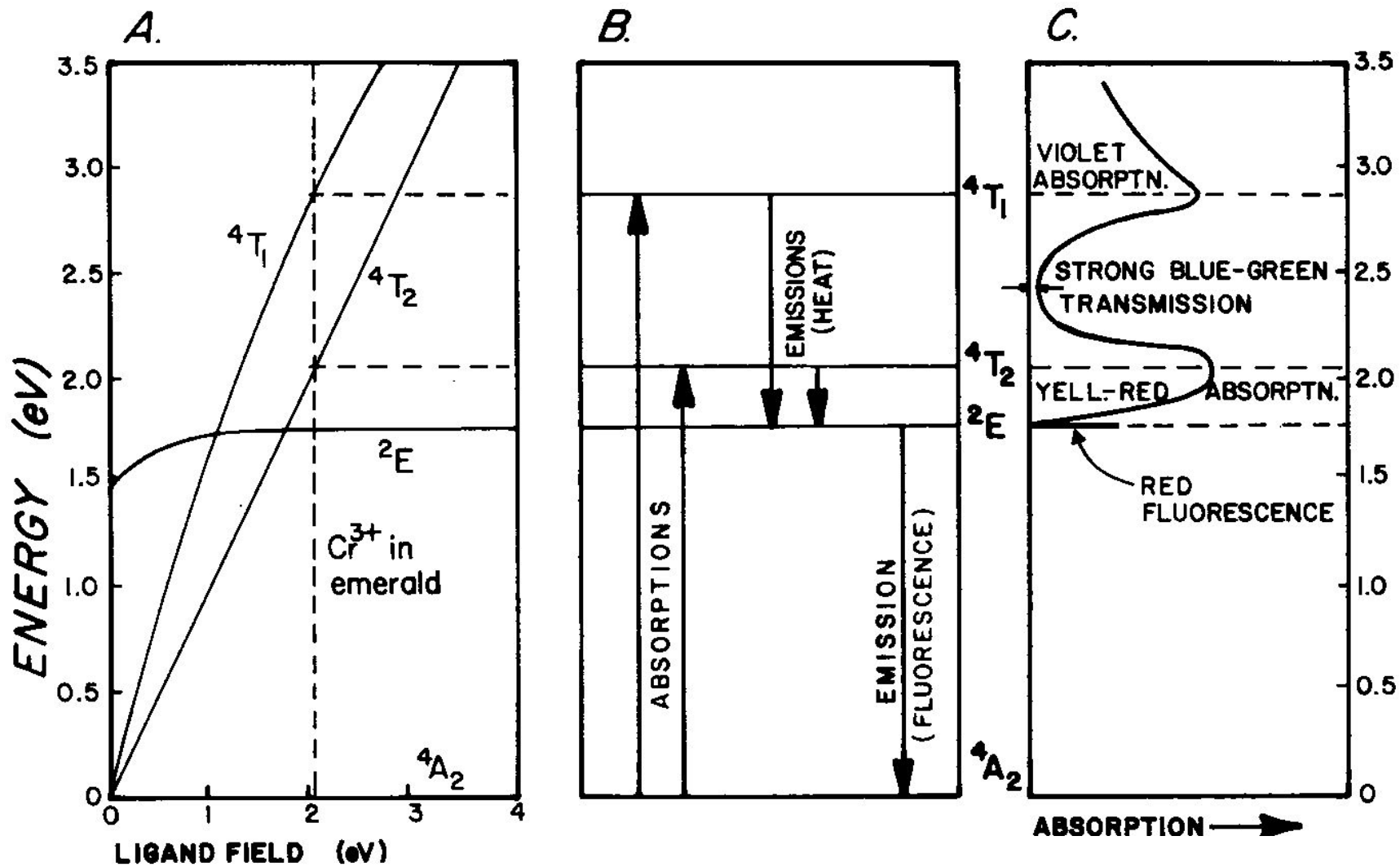



A synthetic alexandrite gemstone, 5 mm across, changing from a reddish color in the light from an incandescent lamp to a greenish color in the light from a fluorescent tube lamp

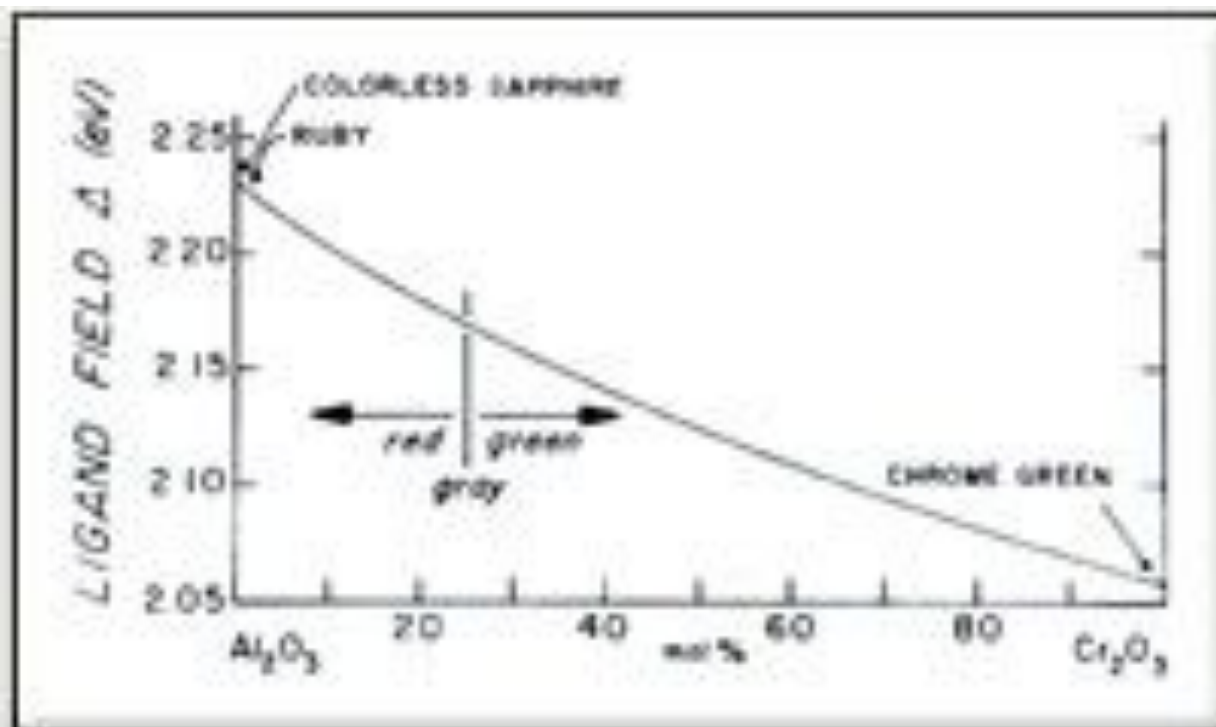



The purple-orange dichroism (Cr^{3+} ligand-field colors) in a 3-cm-diameter synthetic ruby; the arrows indicate the electric vectors of the polarizers

Pleochroism is the ability of a mineral to absorb different wavelengths of transmitted light depending upon its .crystallographic orientations



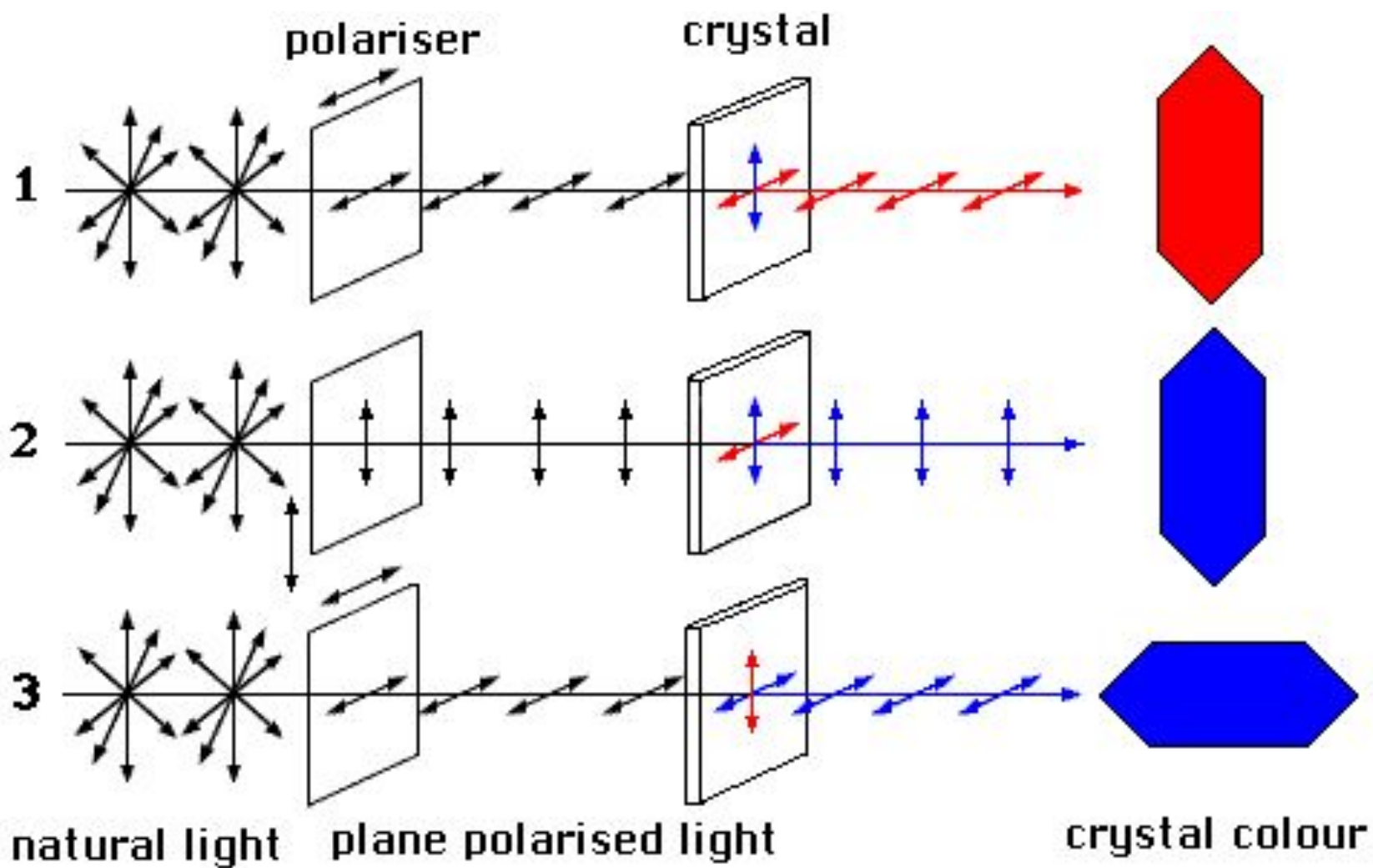

Charge Transfer in Sapphire

The **deep blue** color the gemstone sapphire is also based on impurity sapphire doping into Al_2O_3 . The color arises from the following charge transfer excitation:

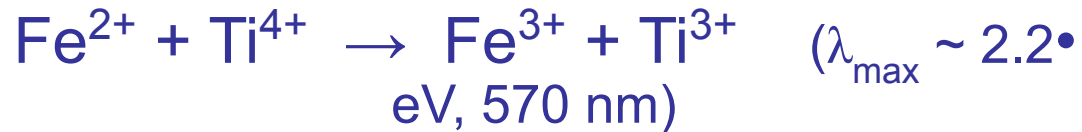

The transition is facilitated by the geometry of the Al_2O_3 structure where the two ions share an octahedral face, which allows for favorable overlap of the d_{z^2} orbitals.

Unlike the d-d transition in Ruby, the charge-transfer excitation in sapphire is fully allowed. Therefore, the color in sapphire requires only $\sim 0.01\%$ impurities, while $\sim 1\%$ impurity level is needed in ruby.

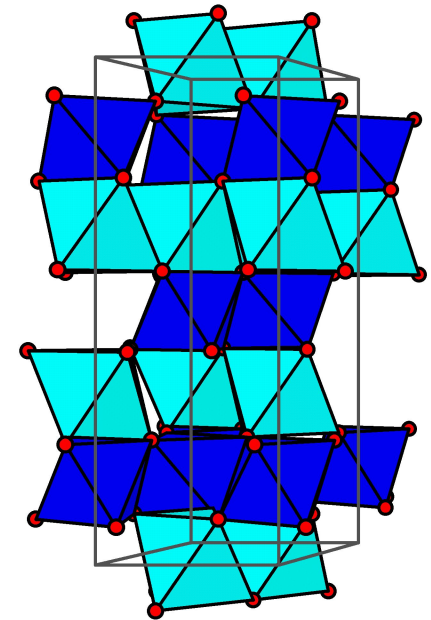

In magnetite, the black iron oxide Fe_3O_4 or $\text{Fe}^{2+}\text{O} \cdot \text{Fe}^{3+}_2\text{O}_3$, there is "homonuclear" charge transfer with two valence states of the same metal in two different sites, A and B



The right-hand side of this equation represents a higher energy than the left-hand side, leading to energy levels, light absorption, and the black color. In sapphire this mechanism is also present, but there it absorbs only in the infrared, as at a in Fig. 16. This same mechanism gives the carbon-amber (beer-bottle) color in glass made with iron sulfide and charcoal, and the brilliant blue color to the pigment potassium ferric ferrocyanide, Prussian blue $\text{Fe}^{3+}_4 [\text{Fe}^{2+}(\text{CN})_6]_3$. The brown-to-red colors of many rocks, e.g., in the Painted Desert, derive from this mechanism from traces of iron

Cu²⁺ Transitions

The **d⁹ configuration of Cu²⁺**, leads to a Jahn-Teller distortion of the regular octahedral geometry, and sets up a fairly low energy excitation from dx²-y² level to a dz² level. If this absorption falls in the red or orange regions of the spectrum, a green or blue color can result.
:Some notable examples include

Malachite (green)•



Turquoise (blue-green)•



Azurite (blue)•

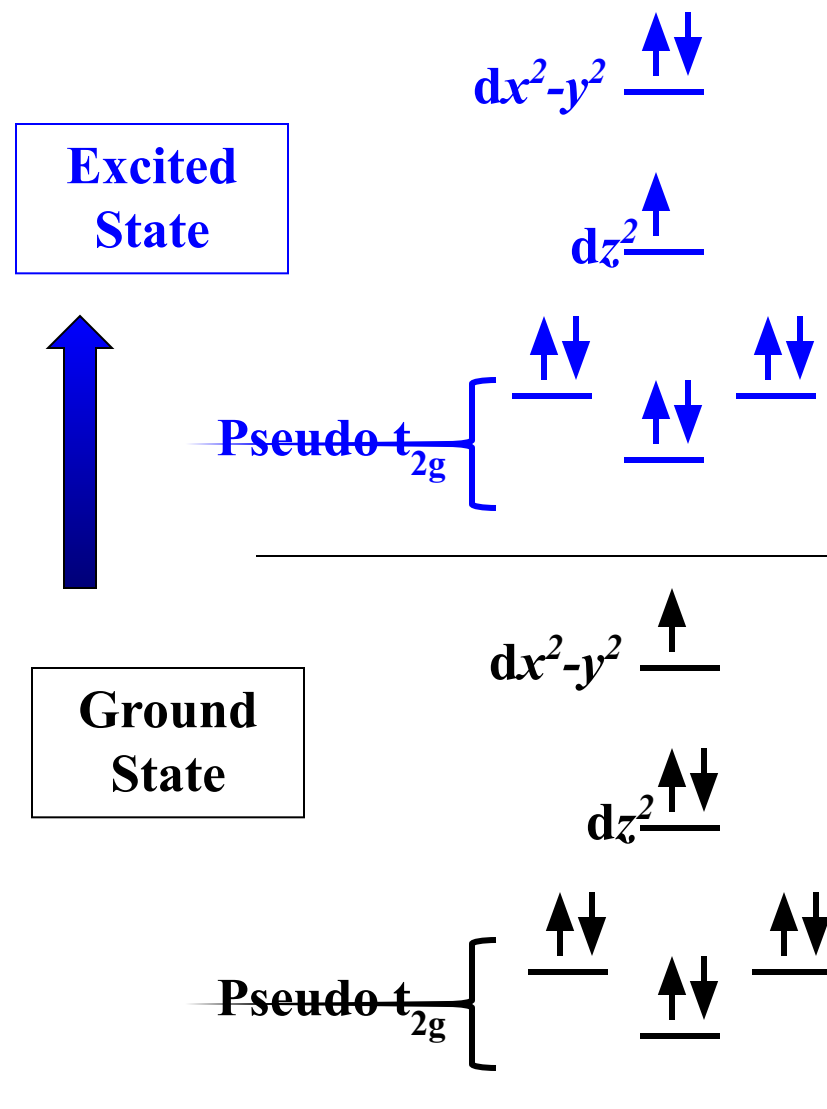
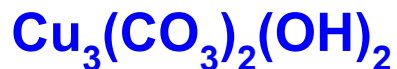

Anion to Metal Charge Transfer

Normally charge transfer transitions from an anion (i.e. O^{2-}) to a cation fall in the UV region of the spectrum and do not give rise to color. However, d^0 cations in high oxidation states are quite **electronegative**, lowering the energy of the transition metal based LUMO. This moves the transition into the visible region of the spectrum. The strong covalency of the metal-oxygen bond also strongly favors tetrahedral coordination, giving rise to a structure containing isolated MO_4^{n-} tetrahedra. Some examples of this are as follows

