

GW4D20 ENGINE MECHANICAL SYSTEM



长城汽车
中国造 长城车



Course Target

- 1.GW4D20 Diesel Engine Parameter & Structure**
- 2.GW4D20 Diesel Engine Assembly Operation**
- 3.GW4D20 Diesel Engine Service Notice**

Topics

- 一、GW4D20 Diesel Engine General Instruction
- 二、GW4D20 Diesel Engine Basic Parameter
- 三、GW4D20 Mechanical System

I .GW4D20 Diesel Engine General Introduction

GW4D20 diesel engine with turbocharger system is developed by Great Wall Motors company itself with great performance, 4 cylinders in-line, force coolant, ω -shaped combustion chamber, 16 valves, double top-positioned camshaft(DOHC), inter-cooler, common rail fuel supply system, VGT system with electronic control EGR valve, powerful, well economic, high durability, low-temperature start easy, emission standard Euro IV、Euro V。

GW4D20 Engine Figure

Front Side

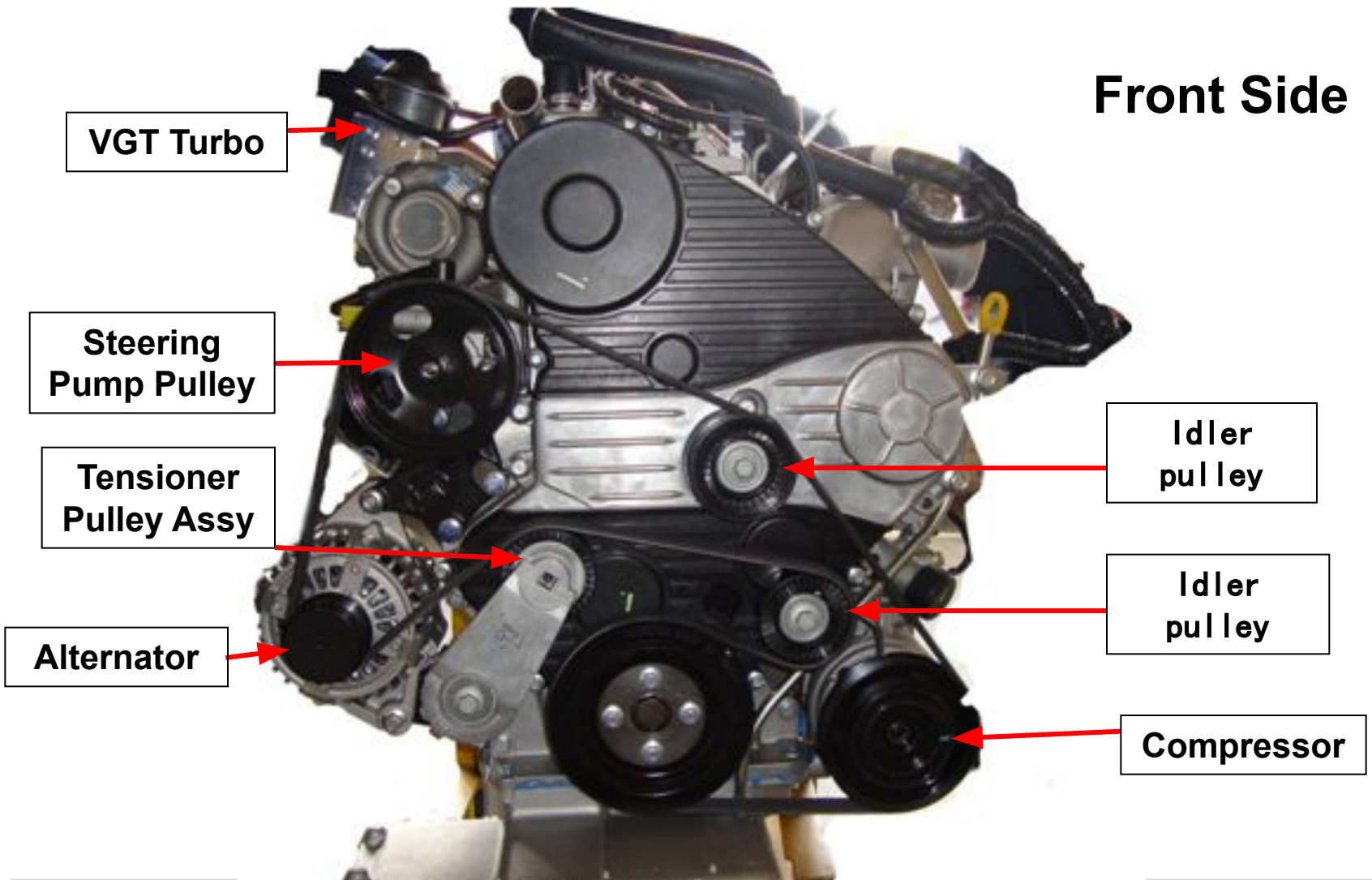

Rear side

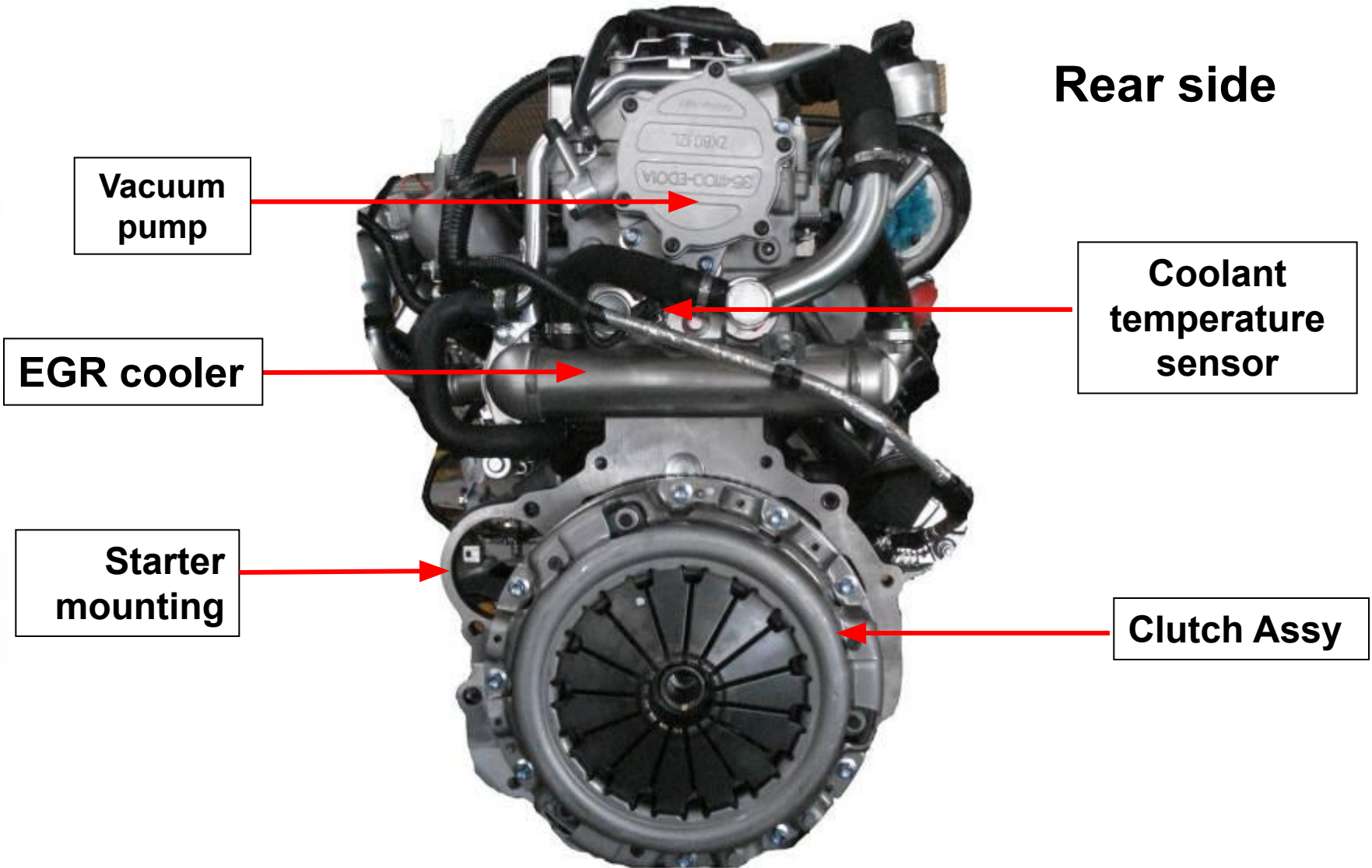

Left side

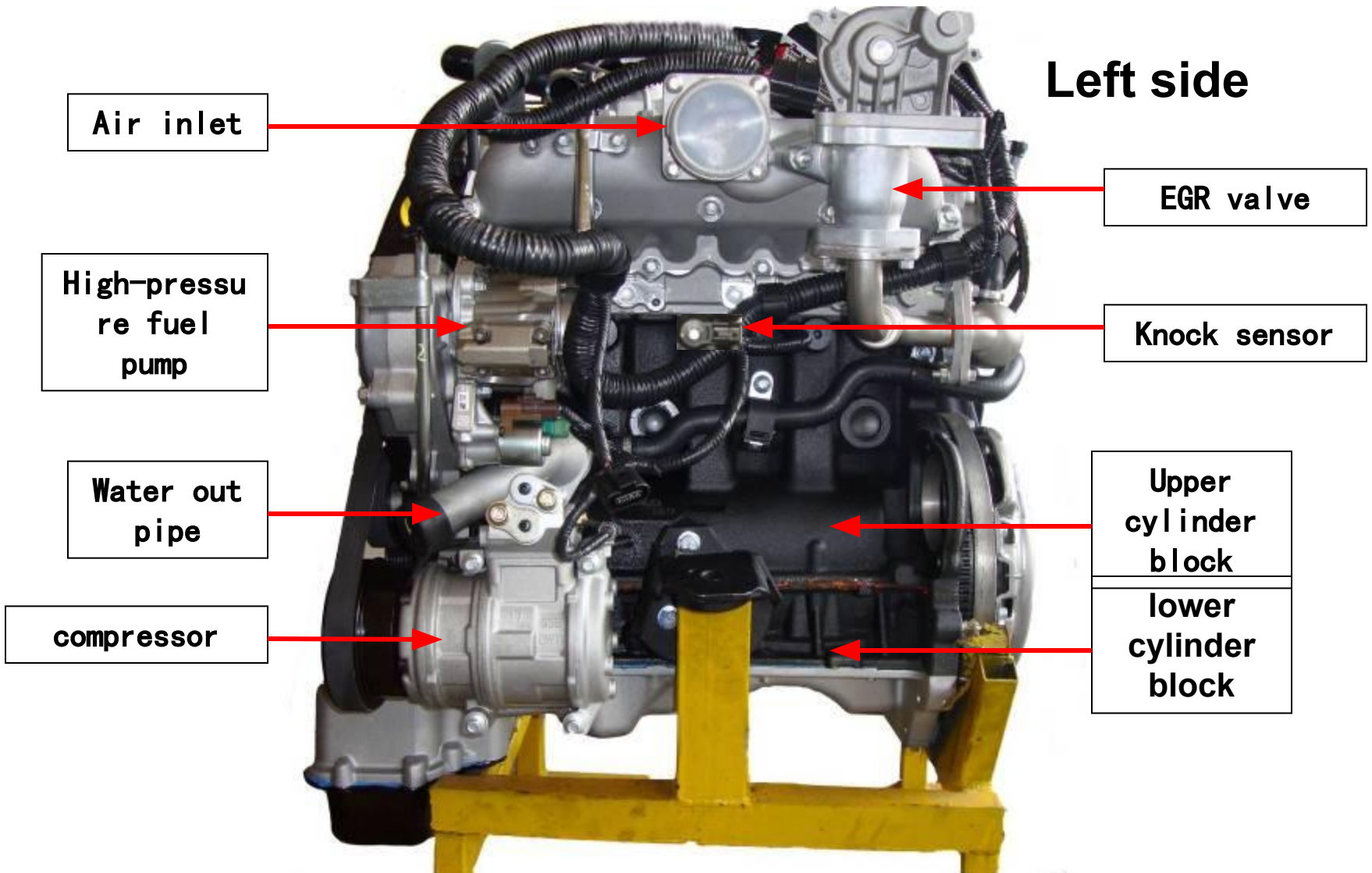

right side

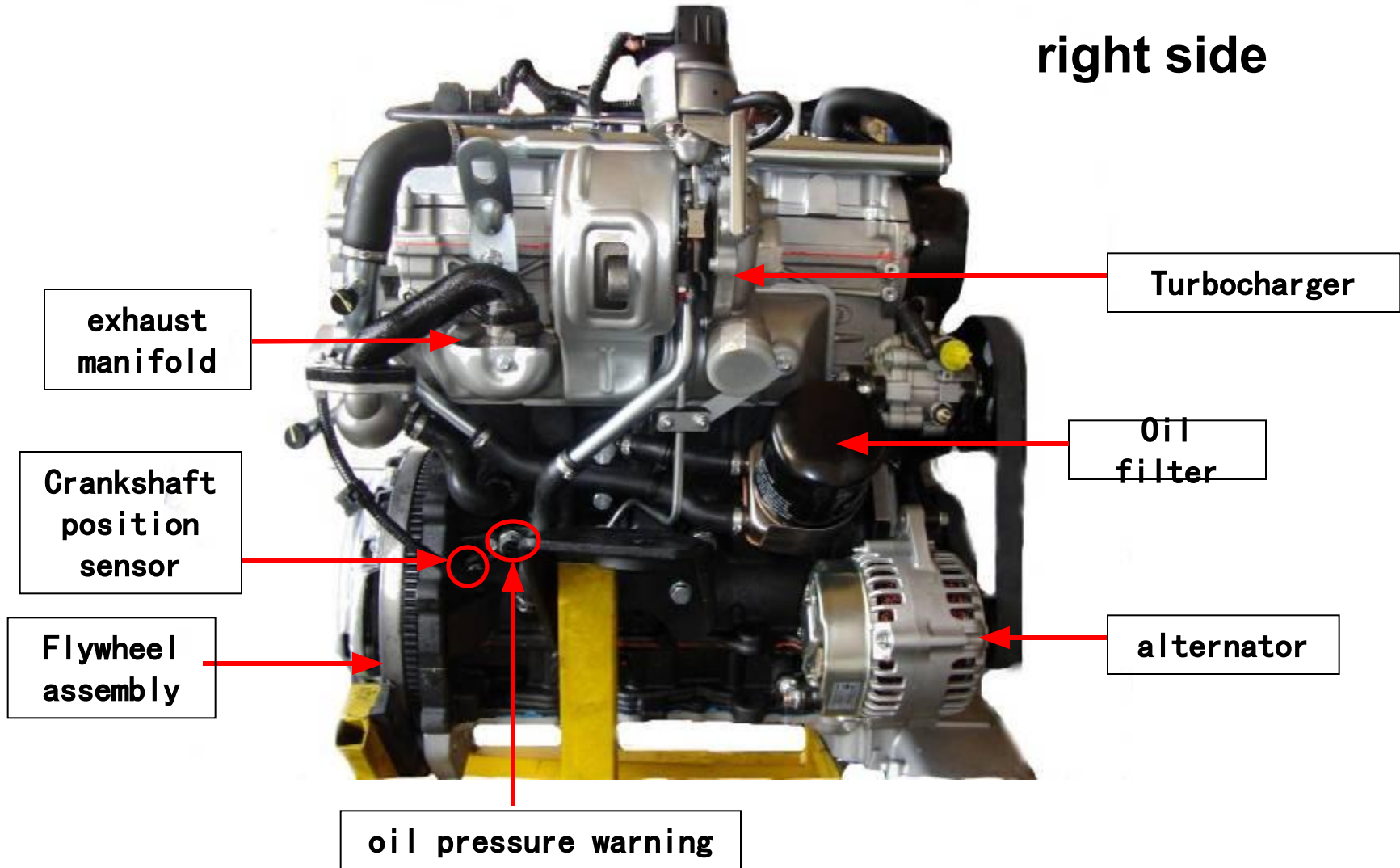

Top side

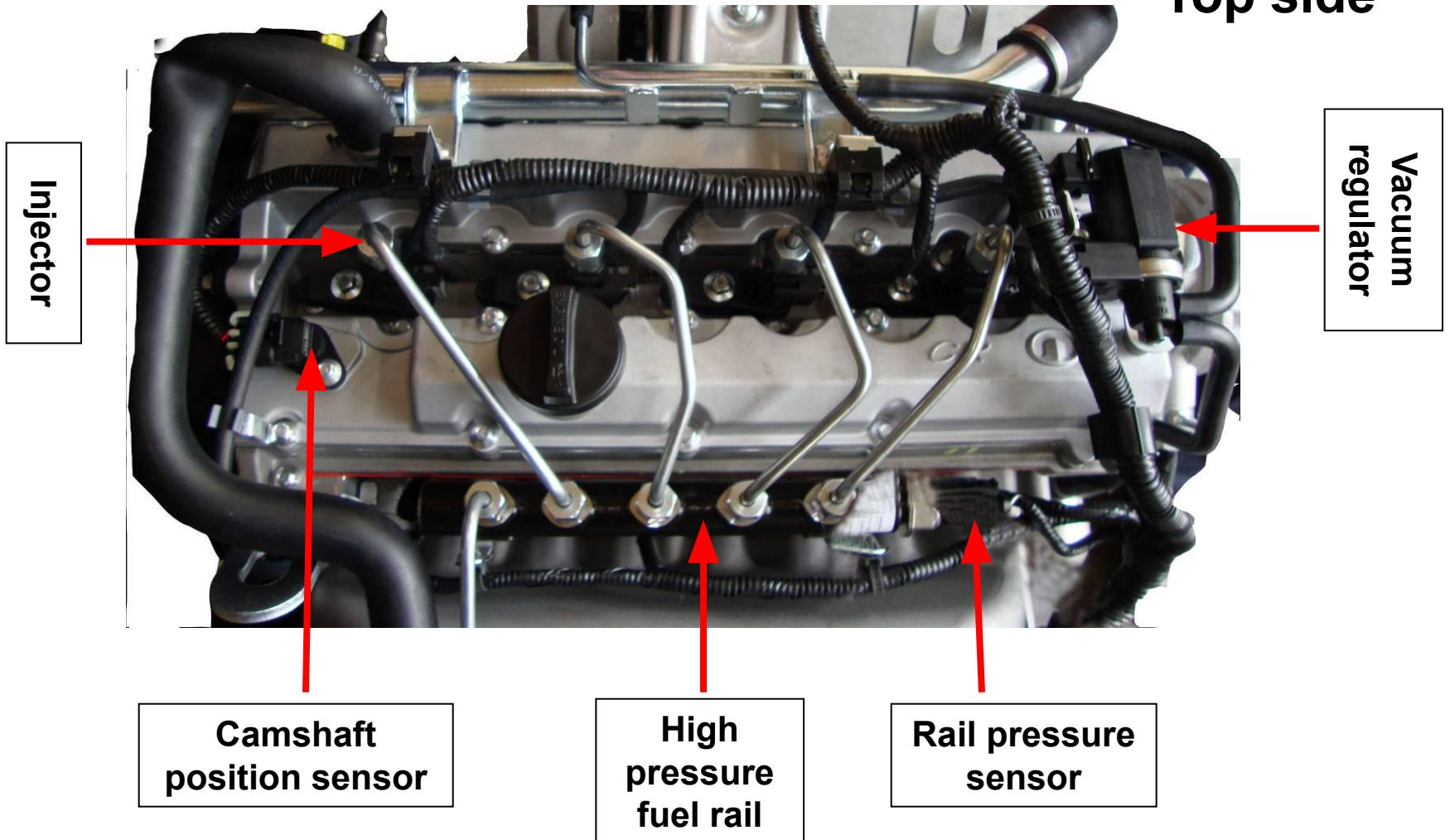

II. GW4D20 Diesel Engine Parameters

Item	Technical specifications
Type	4 cylinder in-line, water cooling, common rail, 16 valves, DOHC, VGT, electronic controller EGR, inter cooler
Combustion chamber type	Necking ω shaped
Bore×stroke	83.1×92 (mm)
Compression ratio	16.7:1
Displacement	1.996 (L)
Working order	1—3—4—2
Rated power/rpm	110/4000 (kw/r/min)
Max. torque/rpm	310/1800~2800 (N·m/r/min)

Item	Technical specifications
Min. fuel consumption rate	≤210 (g/kw.h)
Idle speed	750±50 (r/min)
Max. unload speed	4400 (r/min)
Cylinder compression pressure	3000±5% Kpa (200r/min)
Valve clearance	0 (hydraulic tappet)
Rotation direction (view from the flywheel)	counterclockwise
Max. fuel injection pressure	1600 (Bar)
Fuel injection control	Electronic control
Lubrication	Forced and splash combined
Oil rating	API CI-4
Oil capacity	6 (L)

Item	Technical specifications	Item
Valve timing	Intake valves open (prior to TDC)	24°
	Intake valves close (after BDC)	50°
	Exhaust valves open (prior to BDC)	86°
	Exhaust valves close (after TDC)	16°
Normal working water temperature, Max. temperature, thermostat working temperature (located at the water inlet port)	Normal temperature: 80°C-90°C; Max. temperature: 110°C; Thermostat open temperature: 76°C; Thermostat fully open temperature: 88 °C。	
Total mass (including compressor, steering pump, coolant)	215 Kg	
Exterior size (LxWxH) without transmission	694x625x829 Mm	
Emission level	Euro IV	

GW4D20 other major component technical specifications

Item		Technical specifications
Starter	Volt	12V
	Output power	2 KW
Alternator	Regulation voltage	14.5±0.3 V
	rated currency	110A
turbochar ger	Specification	VGT
	Max. speed	210000 r/min
	Max. continuous working temperature	760 °C
Vacuum pump	Max. speed	2800 r/min
	Max. vacuum	-90 kPa
	Vacuum approach time	To reach up to 50kPa less than 5 s(400 r/min)
Battery	Rated voltage	14V

III. GW4D20 diesel mechanical section

Section I front end components

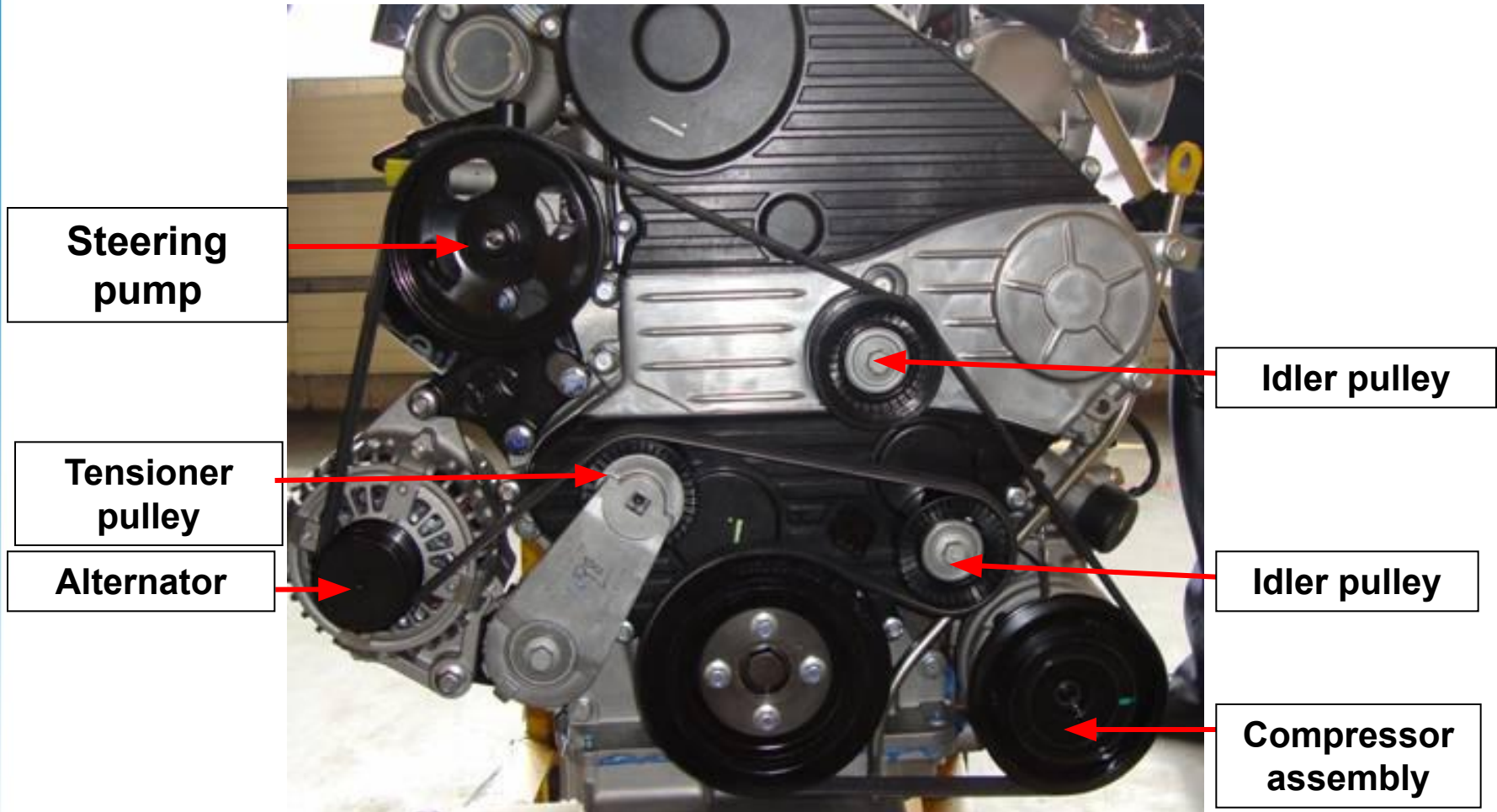

II. Notes in removing the alternator belt

- Remove the belt: turn the tensioner clockwise with torque wrench with on hand, put the tensioner to the bottom position; while pushing out the belt on the idler pulley with the other hand, then loose the tensioner and take the whole belt off.

Tensioner
stopper

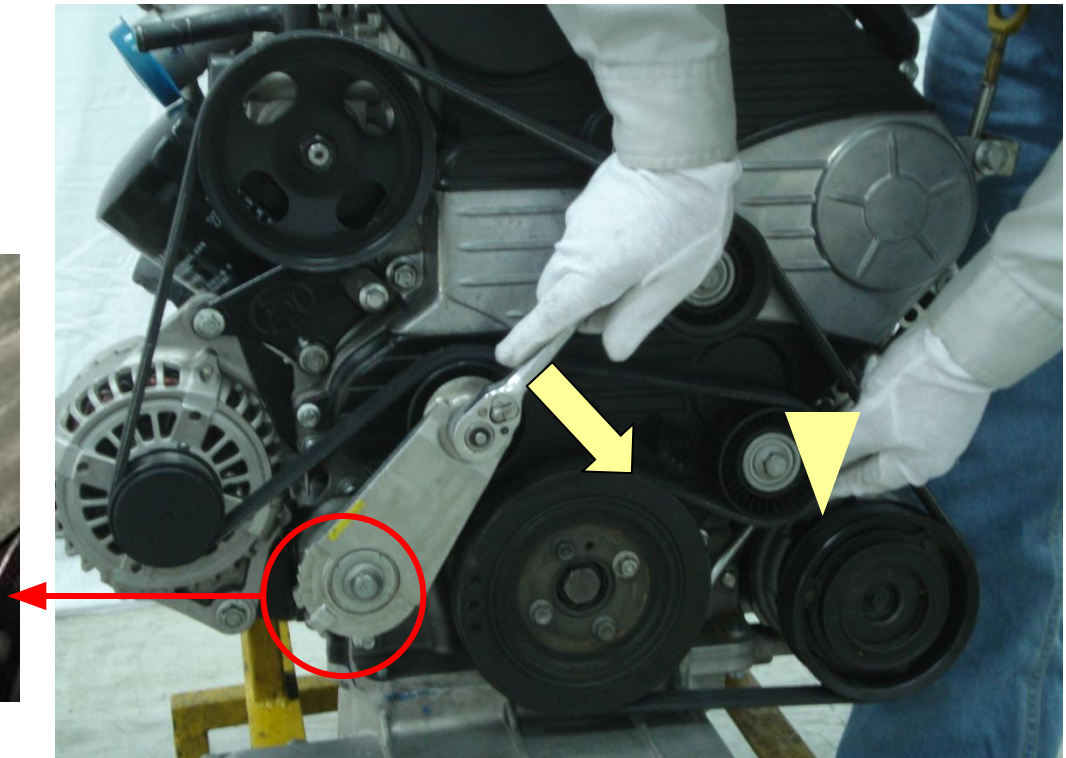

□ Belt assembly : put on the belt according to the sequence shown in the picture, turn the tensioner with the torque wrench clockwise, put the tensioner to the bottom position, while putting the belt on the idler pulley, then loose the tensioner. Make sure the belt teeth fit with the slots on the wedge pulley after installation in place.

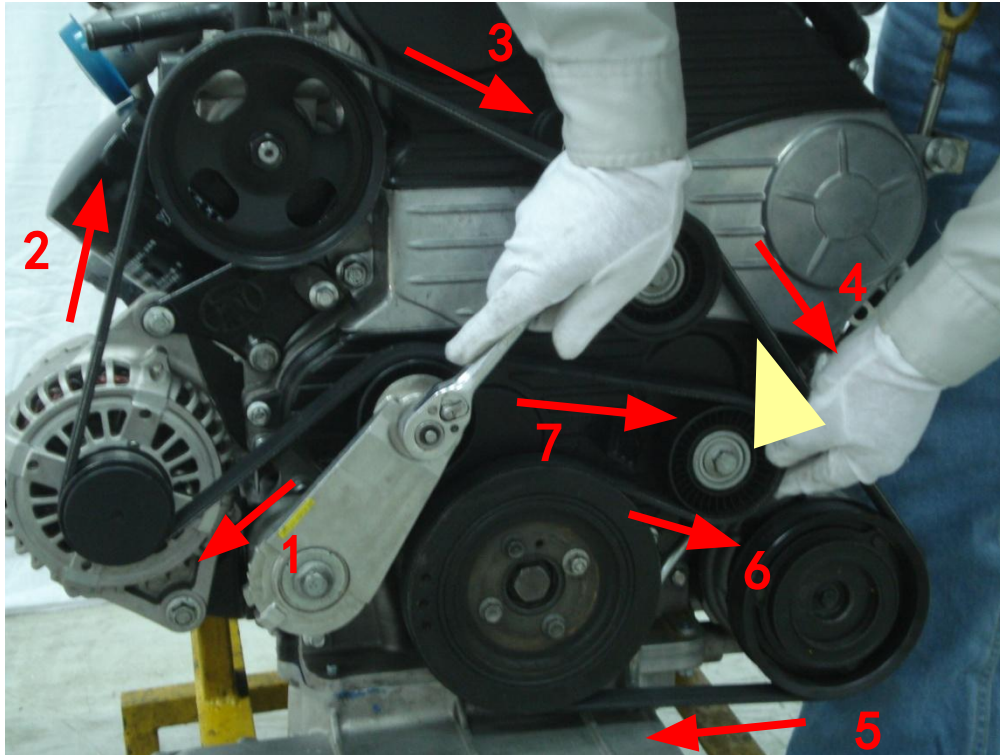

Section II valve mechanism---I. Composition

Timing cover components I

Sealing strip I

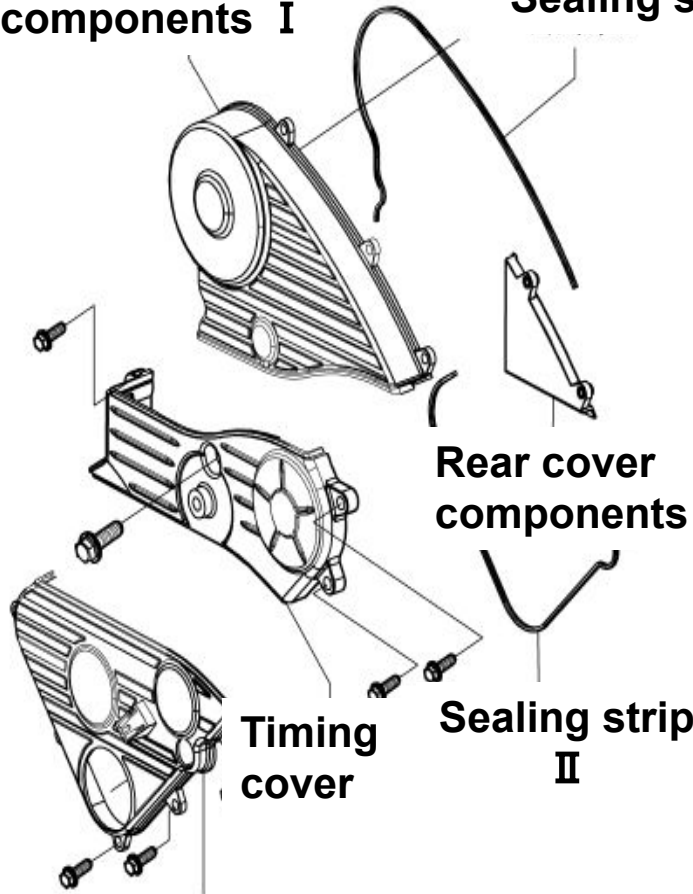

Timing cover components II

Timing system diagram

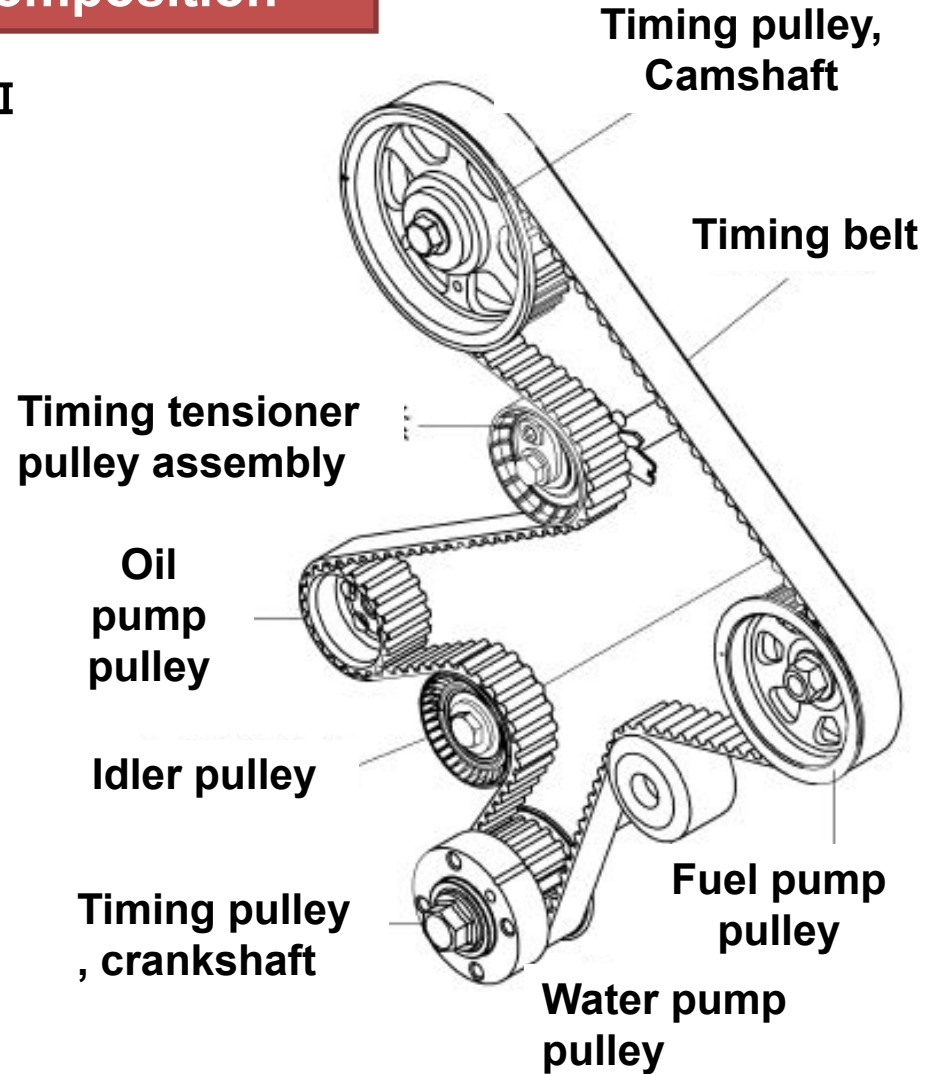

Timing system

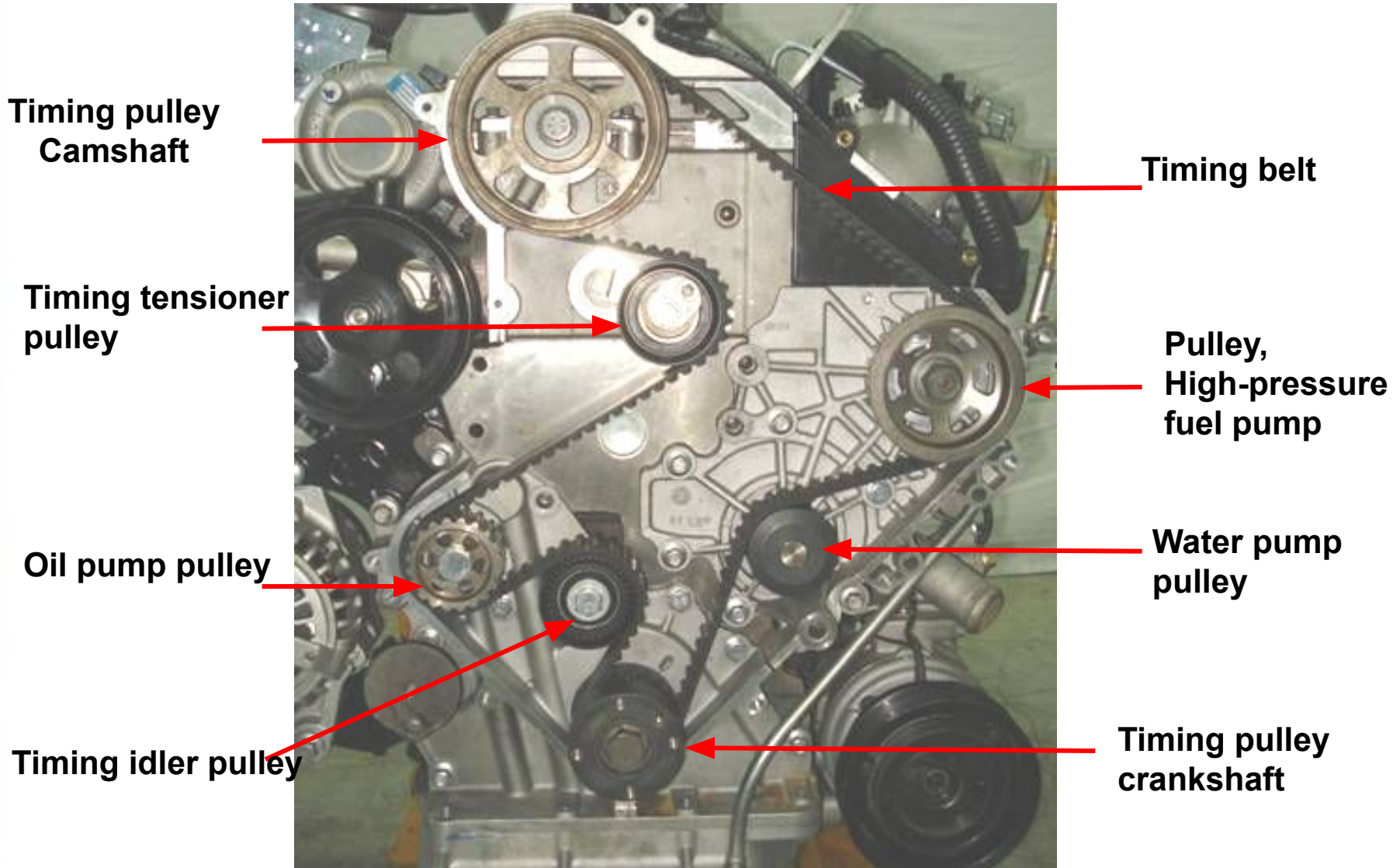

The features of timing system:

- There are totally 7 pulleys in the timing system, more pulleys are involved in the transmission, big span in transmission, big tension in the transmission ;
- To make sure that the timing teeth belt has enough tension, and avoid jumping teeth, teeth fall off and compensation for the extending of timing belt, the system adopts the automatic tension design. Because the tensioner pulley is eccentric shaft bearings design, and the tensioner pulley suffers and offers great tension, then it requires high performance for the component itself and assembly.



Timing tensioner pulley



Timing idler pulley

Notice:

Timing belt have to be changed at 80000km

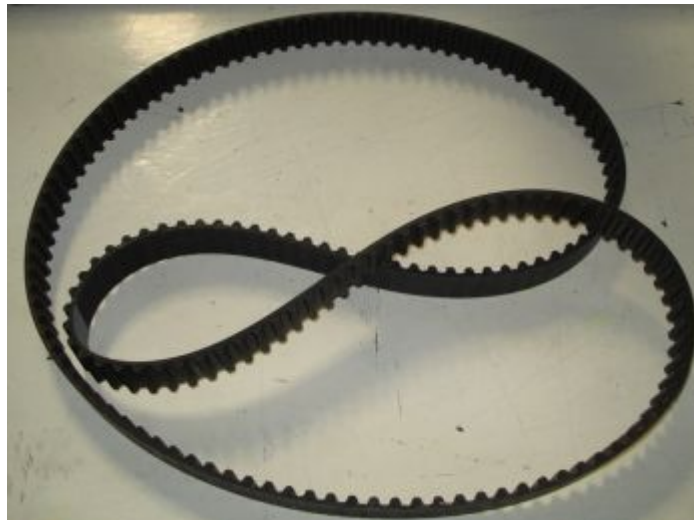

Timing belt

II. timing pulley change

Important notes in changing timing pulley:

- environment must be clean**
- correct timing position**
- Correct tightening torque**
- The direction and sequence to put in the belt**
- Validate the timing**

1. check if the belt is good and take the timing pulley off

□ Check if scratch and wear and missing teeth and oil and water are on the belt

□ Loose the tightening bolt of the tensioner, take off the tensioner

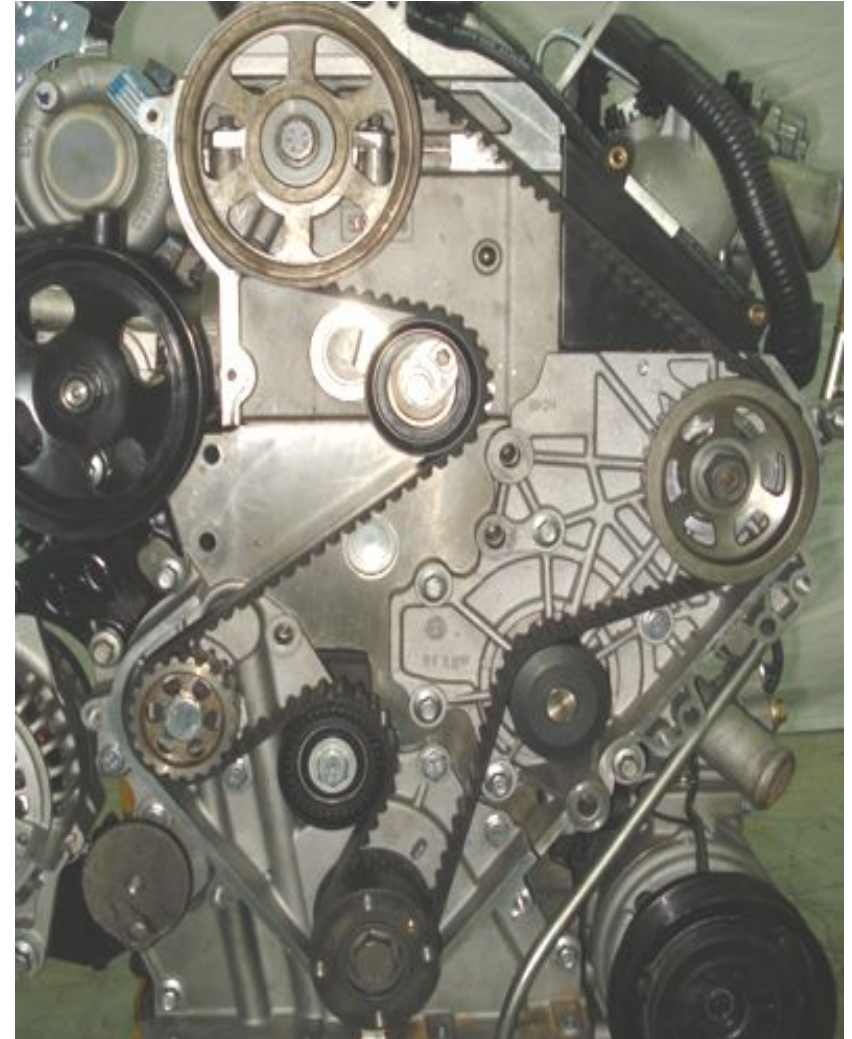

2、Timing alignment



□ camshaft pulley mark matches integration seam between cylinder head and camshaft bearing cover



Crankshaft pulley mark matches the arrow of oil pump housing

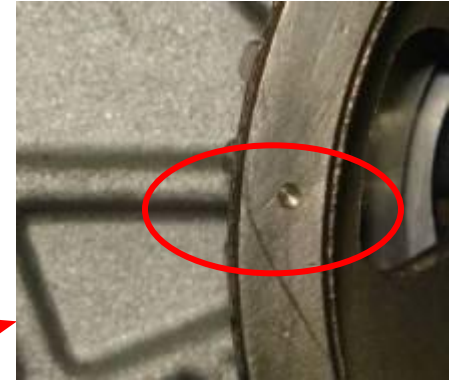
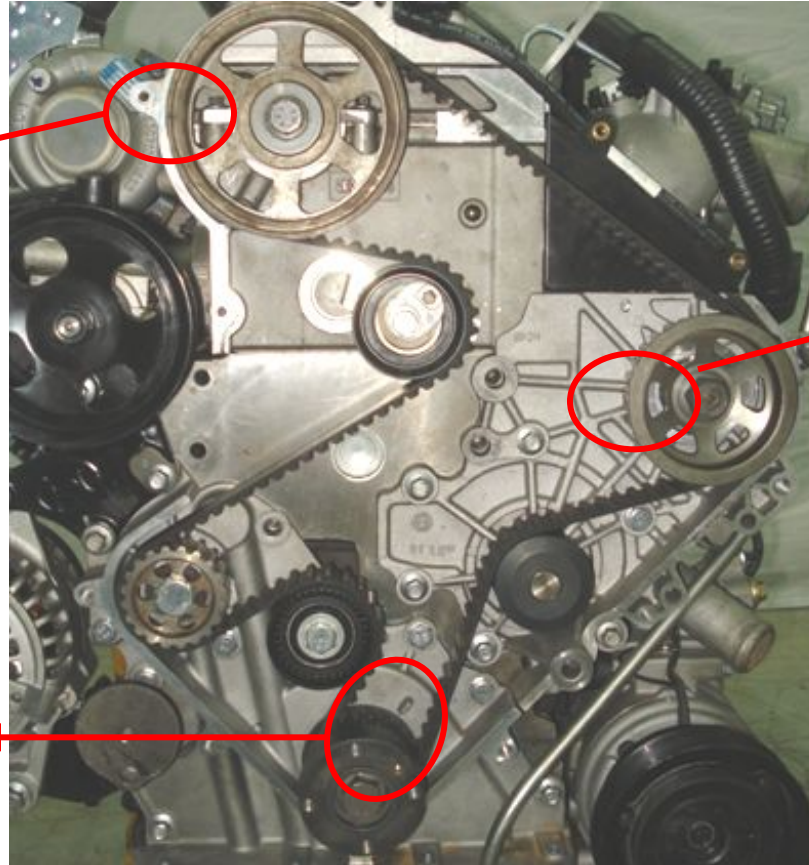

□ align the mark of high-pressure fuel pump pulley with the leveling rib of water pump shell

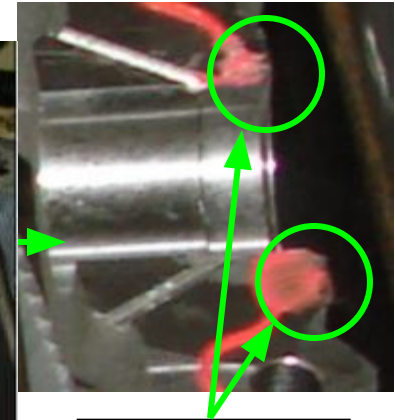
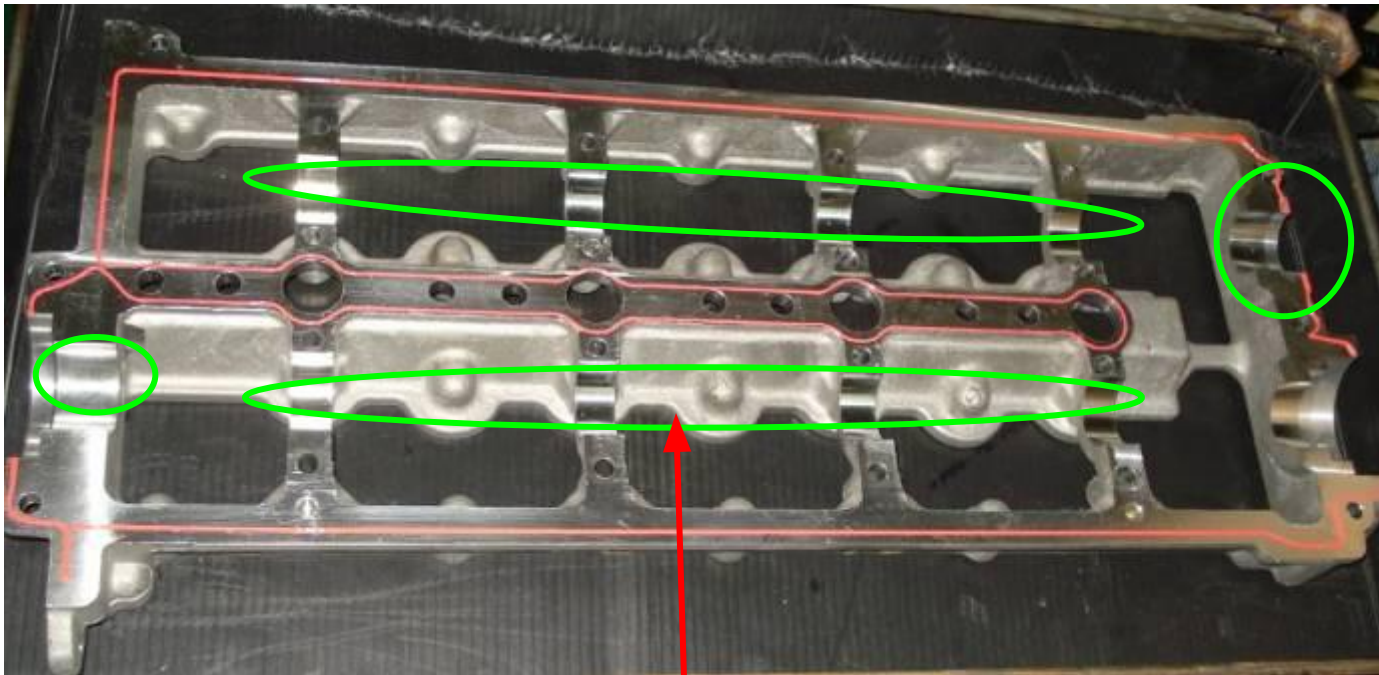

Press the
glue line
on this
position

Glue is prohibited
from implementing
on the camshaft
bearing

3、Installing of timing belt

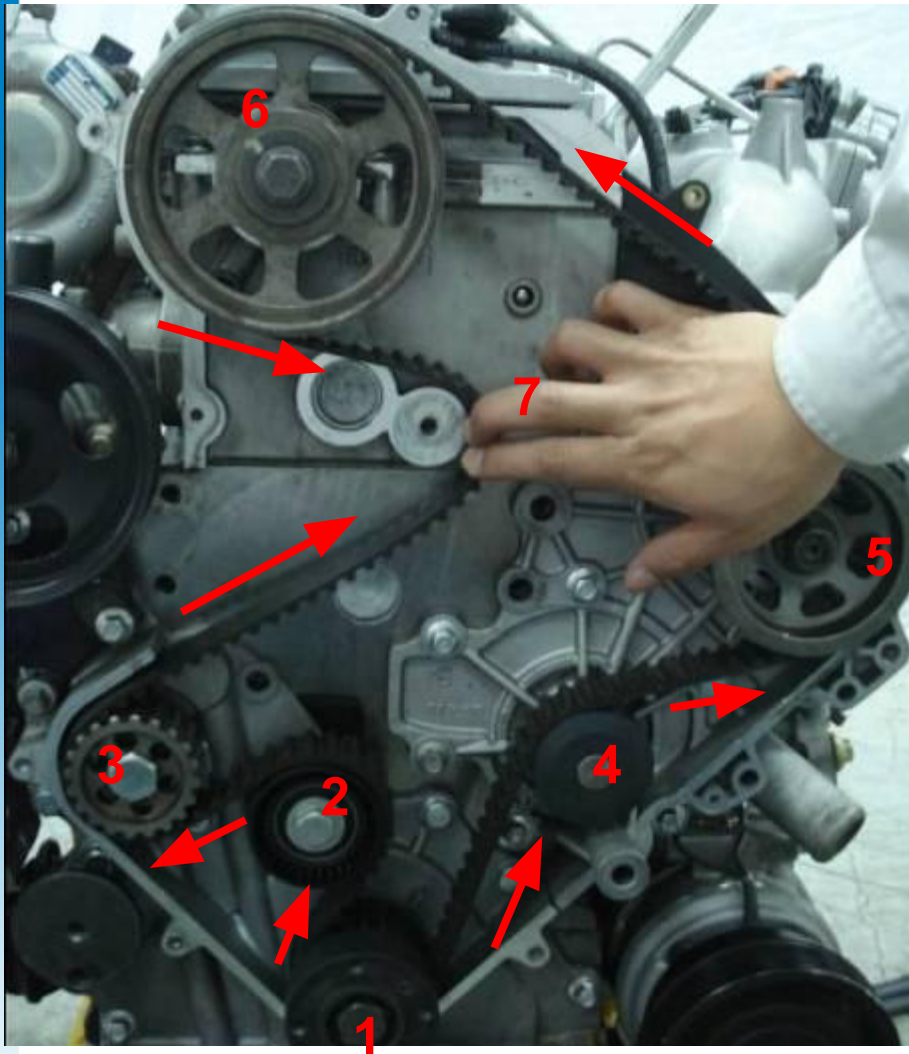

Put the belt according to order 1-7, make sure the belt contact with the pulley firmly without loosening except the idler pulley.

Process

- 1 timing pulley ,crankshaft
- 2 idler pulley
- 3 oil pump pulley
- 4 water pump pulley
- 5 High-pressure fuel pump pulley
- 6 camshaft pulley
- 7 Timing tensioner

4、installing of timing tensioner



First, put the stop bracket of the tensioner into the position of cylinder head bowl plug, then put on the tightening bolt without tightening, then adjust tensioner pin hole with hex wrench till the tensioner arm pointer exceeds the installation gap by $1\sim 2$ degrees, finally tighten the bolt with torque $24\pm 2\text{N.m}$.

5 timing check

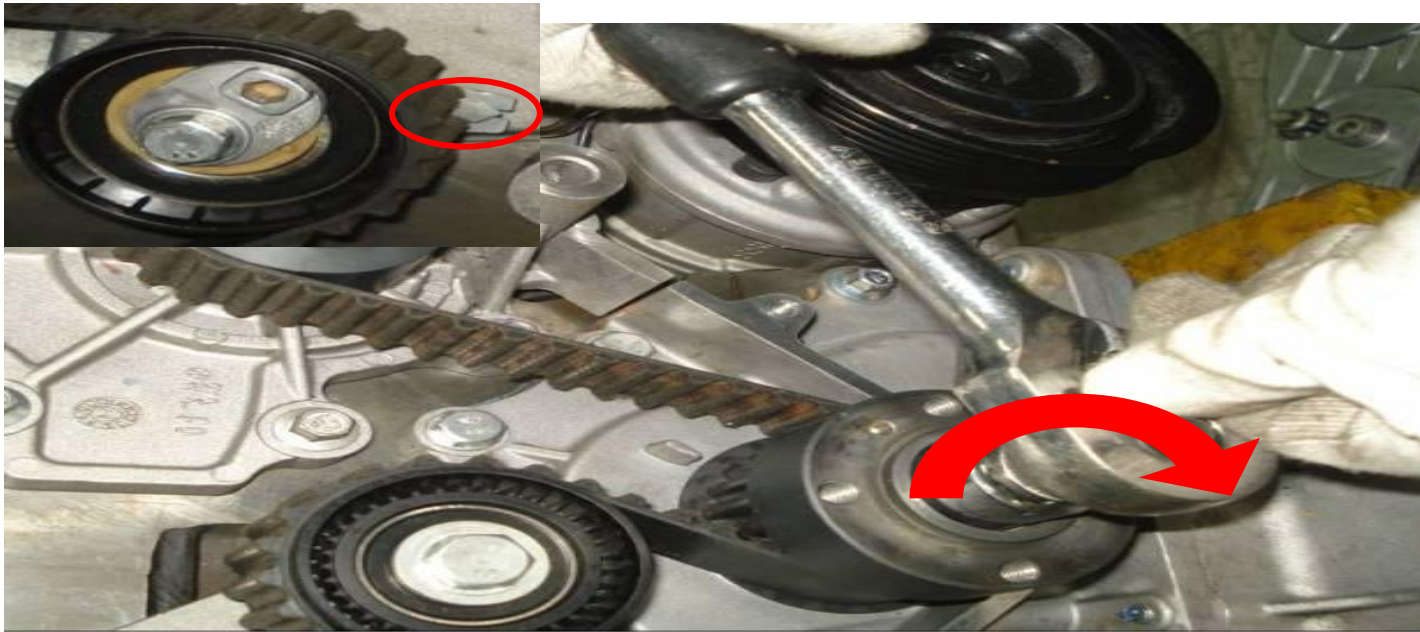

To rotate crankshaft clockwise twice and ensure if **timing crankshaft pulley and timing camshaft pulley** match exactly with belt , check if automatic tensioner needle matches with gap position, check whether tightening torque of the tensioner is correct, re-adjust if any abnormal happens.

Chapter III Cylinder head

I cylinder head composition

Cylinder diesel GW4D20 is made of aluminum alloy, there are water jacket and intake & exhausting manifolds and lubrication gallery in the cylinder , there are seat hole and flat surface for fuel injector & glow plug & valve seat ring & hydraulic tappet & rocker arm & cylinder head cover.

The exhaust & Intake valves and valve guide and exhaust & Intake camshaft assemblies and exhaust & Intake manifolds and rocker arm and hydraulic tappet and fuel injector and glow plugs and high-pressure fuel rail are assembled on the cylinder head.

cylinder head

Cylinder head cover assembly

Camshaft bearing cover

exhaust & Intake camshaft

Cylinder head assembly

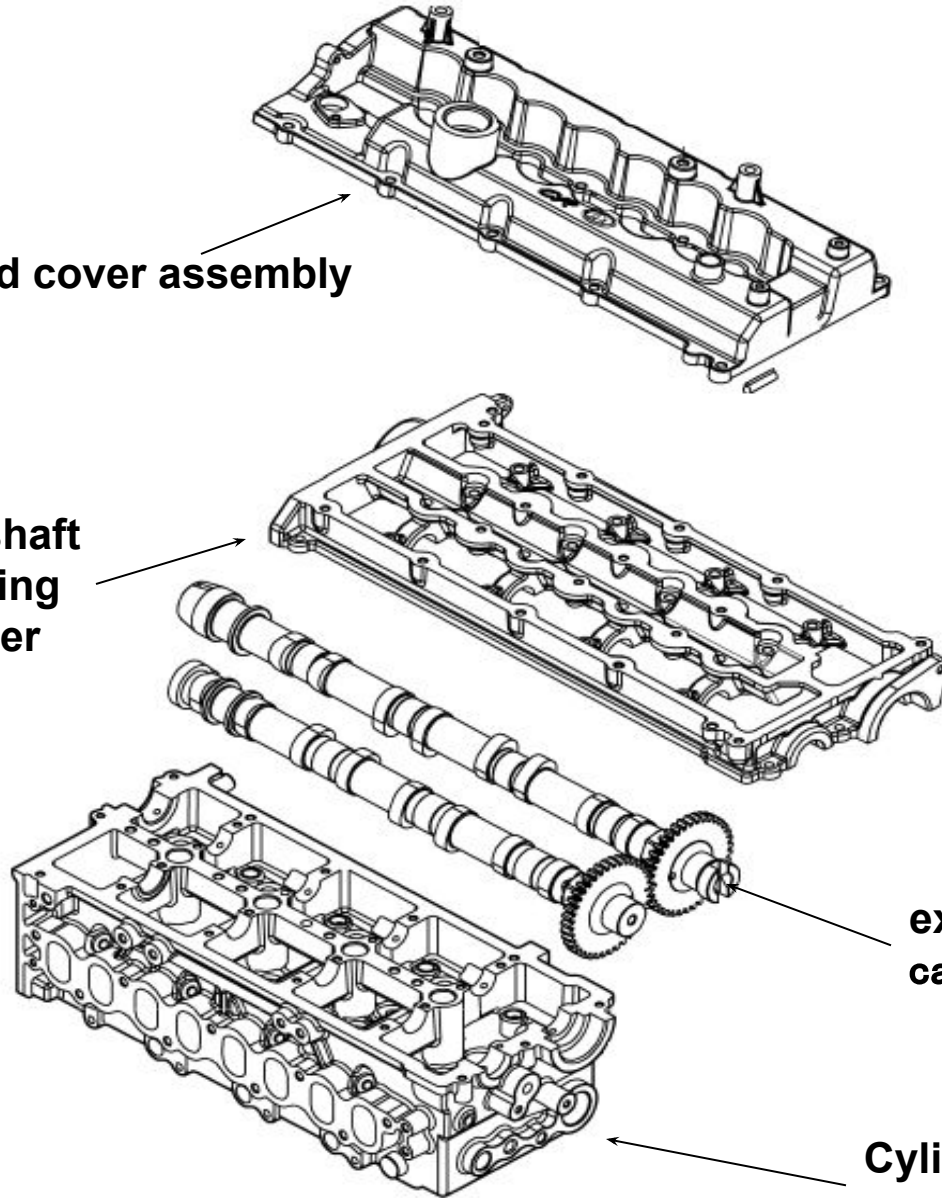

Oil passage

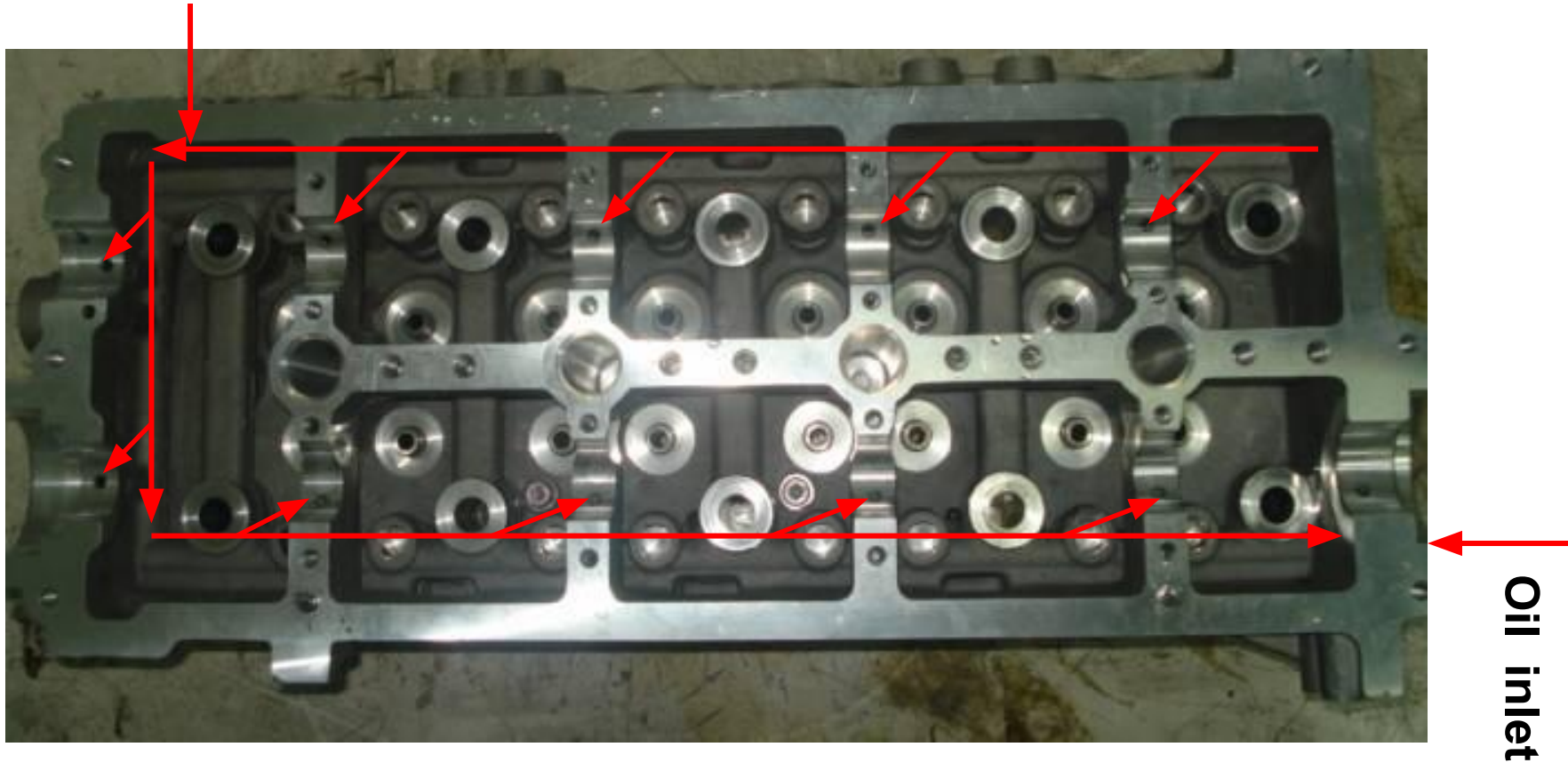

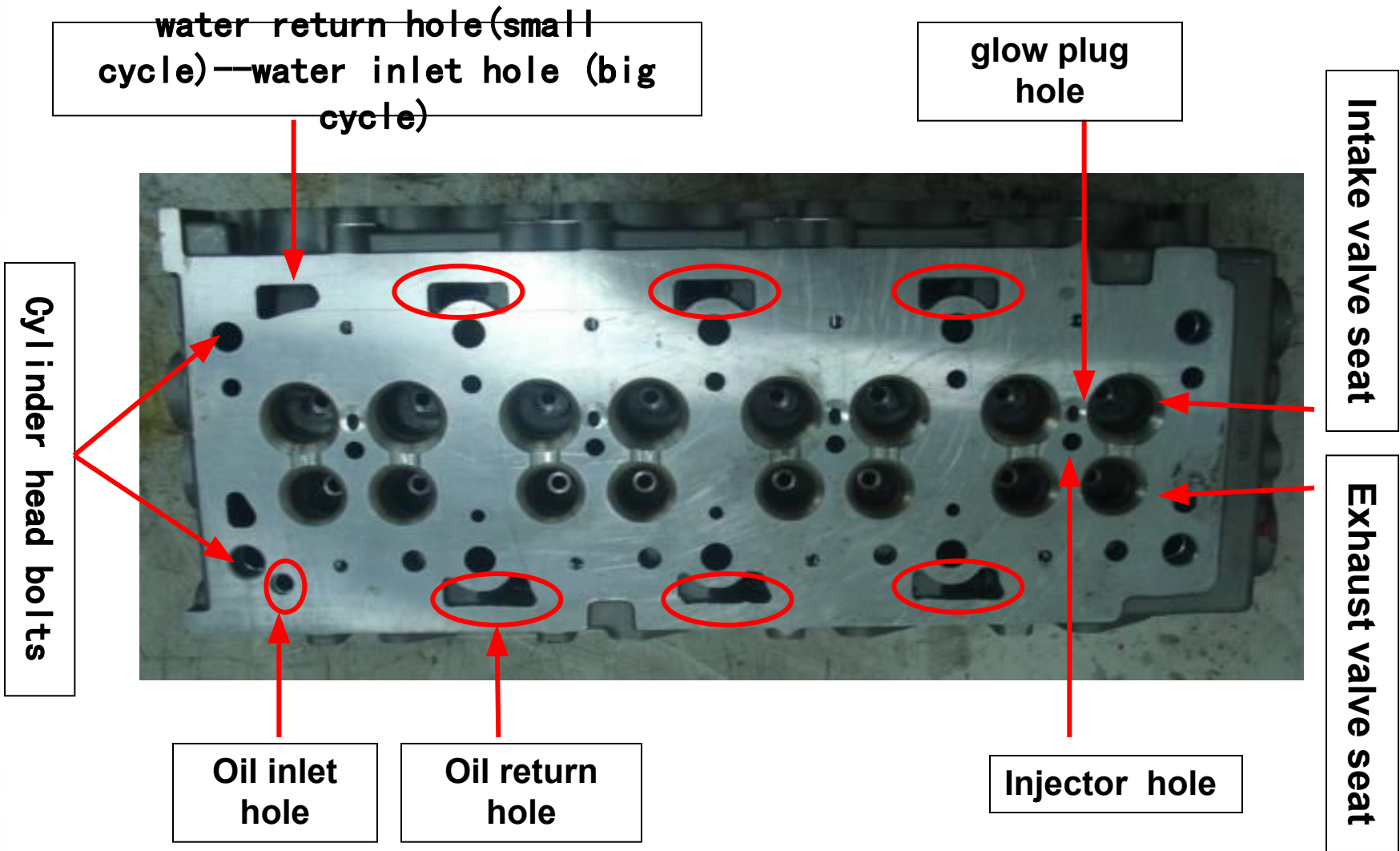

II camshaft and Intake & Exhaust valve components

- Double Overhead Camshaft is used for GW4D20 diesel , the DOHC includes Intake & exhaust camshafts, each camshaft has 8 cams ,each cam controls open/close of one valve.
- Exhaust camshaft is the drive shaft , the intake camshaft is driven through the chain, there is a signal panel installed in front of the intake camshaft, the front oil seal is located at the exhaust camshaft side, the vacuum pump is at the rear end of exhaust camshaft.

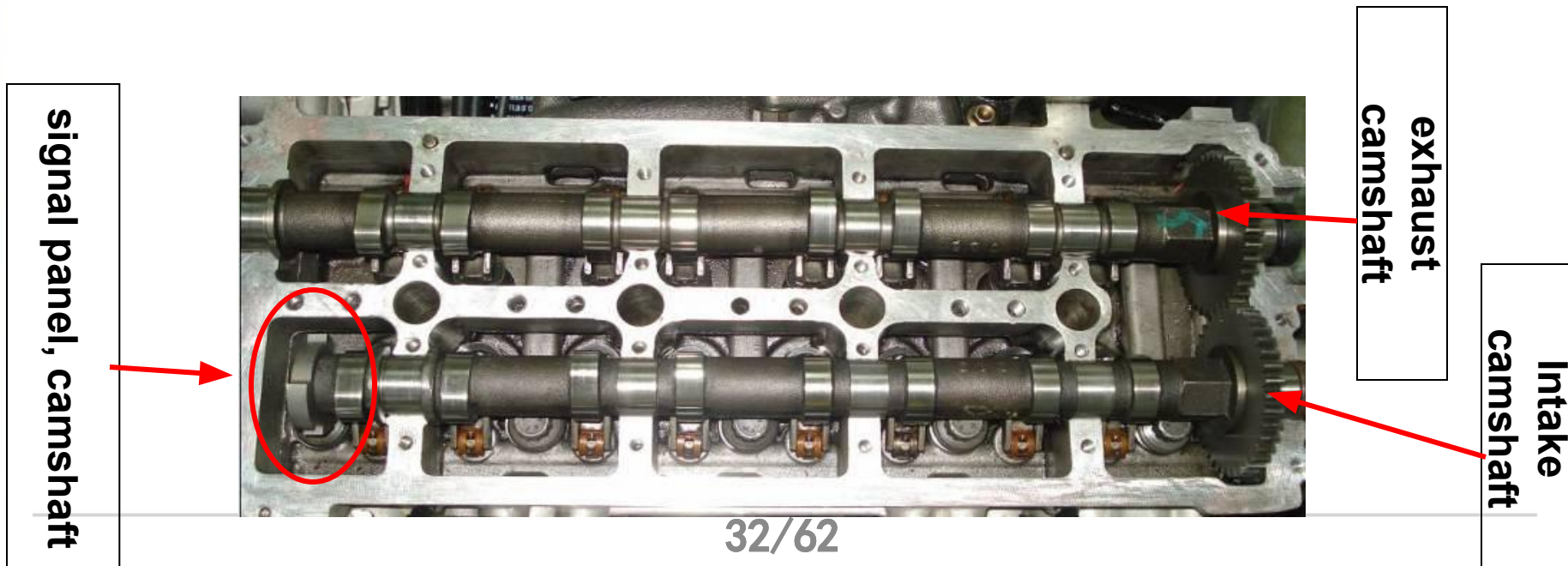

- Intake & exhaust valve are arranged vertically on the cylinder head , the open & close of valves are controlled by the movement of the camshaft rotation, hydraulic pressure regulator, valve rocker movement . In order to acquire high air charging efficiency, intake valve diameter is bigger than exhaust valve.
- Hydraulic clearance regulator is used to compensate the valve clearance automatically. Compare with direct drive valve tappet, the advantage is smaller noise and simple installation.



intake valve

roller rocker and hydraulic tappet

exhaust valve

Lock clamp

hydraulic tappet

roller rocker

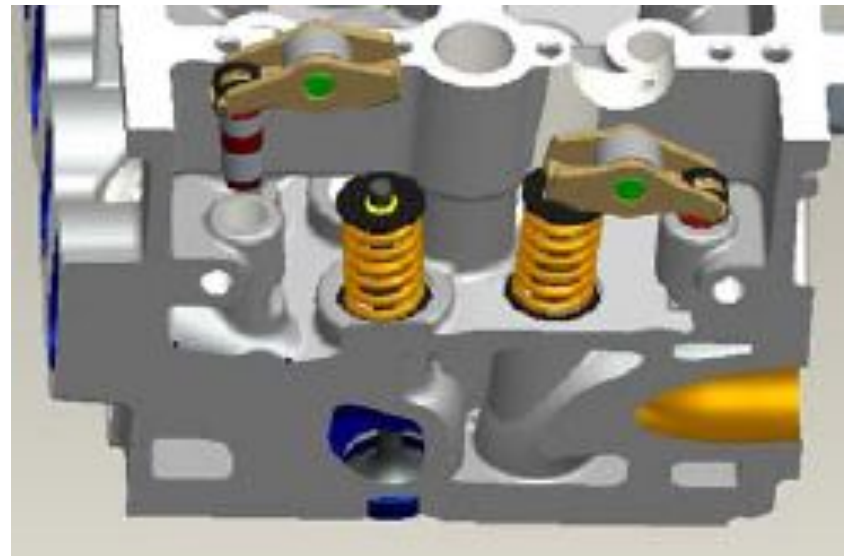

III notices in installation

1. The water outlet pipe set at the read end of the cylinder head and installation position are **interference fit** , outlet pipe assembly pressed into the end to apply a round of sealant 962T on the pressing end of the water outlet set, the sealant width is 3~5mm ,the thickness is 0.5mm. The water outlet pipe connector must align with the mark on the cylinder head. Apply Loctite 262 sealant to the thread of the coolant temperature sensor to prevent from water leaking.

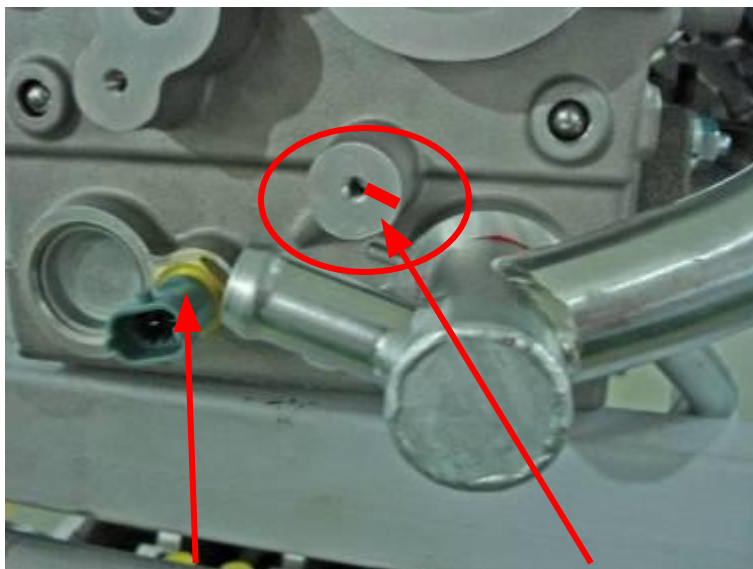

coolant temperature sensor

Mark for alignment



Pressing end of water outlet pipe

2. notices in intake & exhaust camshaft installation

- **Mark alignment:** align the "mark" on the intake & exhaust camshafts, while leveling with the upper coupling surface of the cylinder head;
- **Install the plug cover:** apply clean lubrication oil on the outer circle of the rear plug cover of the intake camshaft, then put it into the rear plug cover hole, then install the camshaft bearing cover. Make sure the plug cover hole is clean, the plug cover is set in place, or it will cause poor sealant of the plug cover and oil leakage.

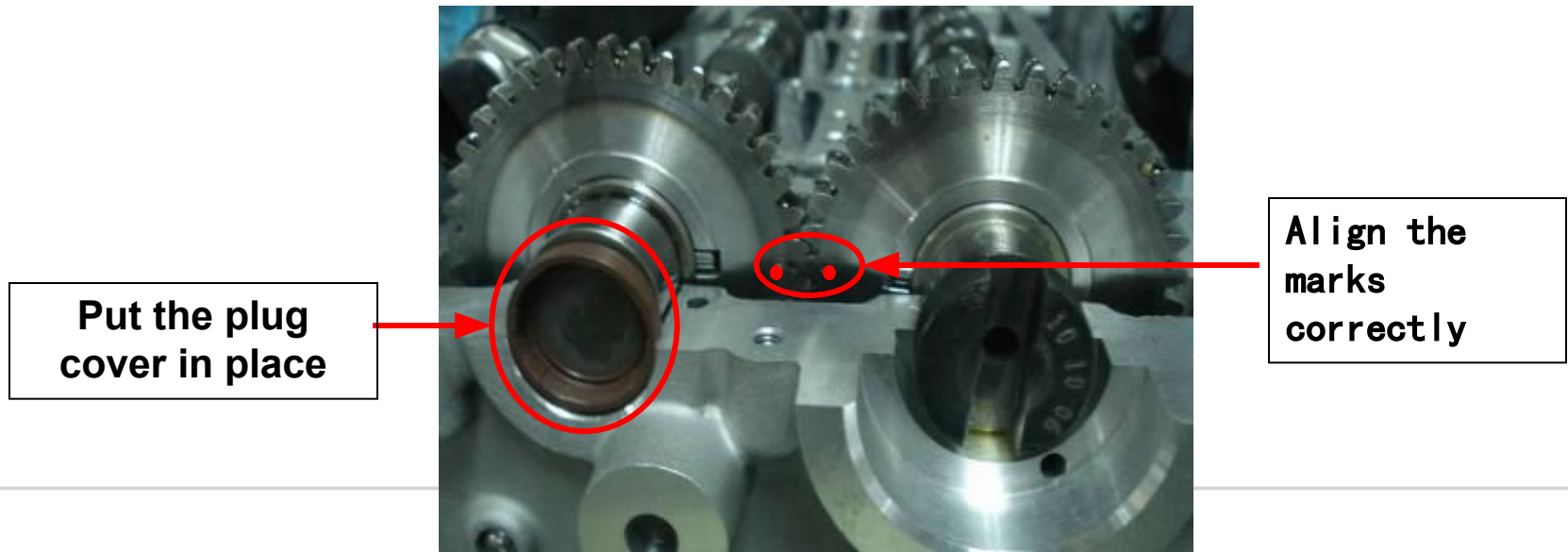

Notices in installing the front oil seal of the camshaft : as there is little sealant pressed out of the front oil seal hole when pressing the camshaft bearing cover, it shall be cleaned before install the oil seal. Apply proper amount of clean oil on the out circle of the camshaft front oil seal, press the it into the hole with SST.



oil seal hole must be cleaned

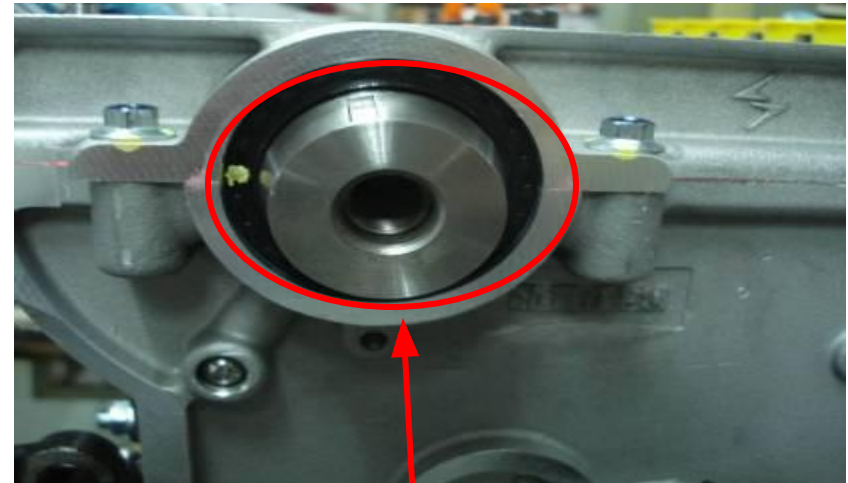

Oil seal pressed into place

3. notices in applying the glue on the camshaft bearing cover

- Clean the camshaft bearing cover, bearing and cylinder head coupling surface with the carburetor detergent before apply the glue.**
- Apply one circile of loctite 510 anaerobic adhesive on the camshaft bearing cover, the requirements are as follows: :**
 - ① The glue application range is 0.8~1.2mm(Diameter)--outline border position**
 - ② The glue application range is 0.4~0.6mm(Diameter)—middle position, make sure apply the glue evenly, and avoid the sealant from pressing into the engine inside.**
 - ③ The glue lines within 10mm on the 5th intake camshaft hole shall be pressed evenly, never smear it inside the hole.**
 - ④ glue and impurity is not allowed to exist on the camshaft bearing and round its edges, ensure the cleanness, or it may lead to camshaft stuck.**

4. Cylinder head tightening

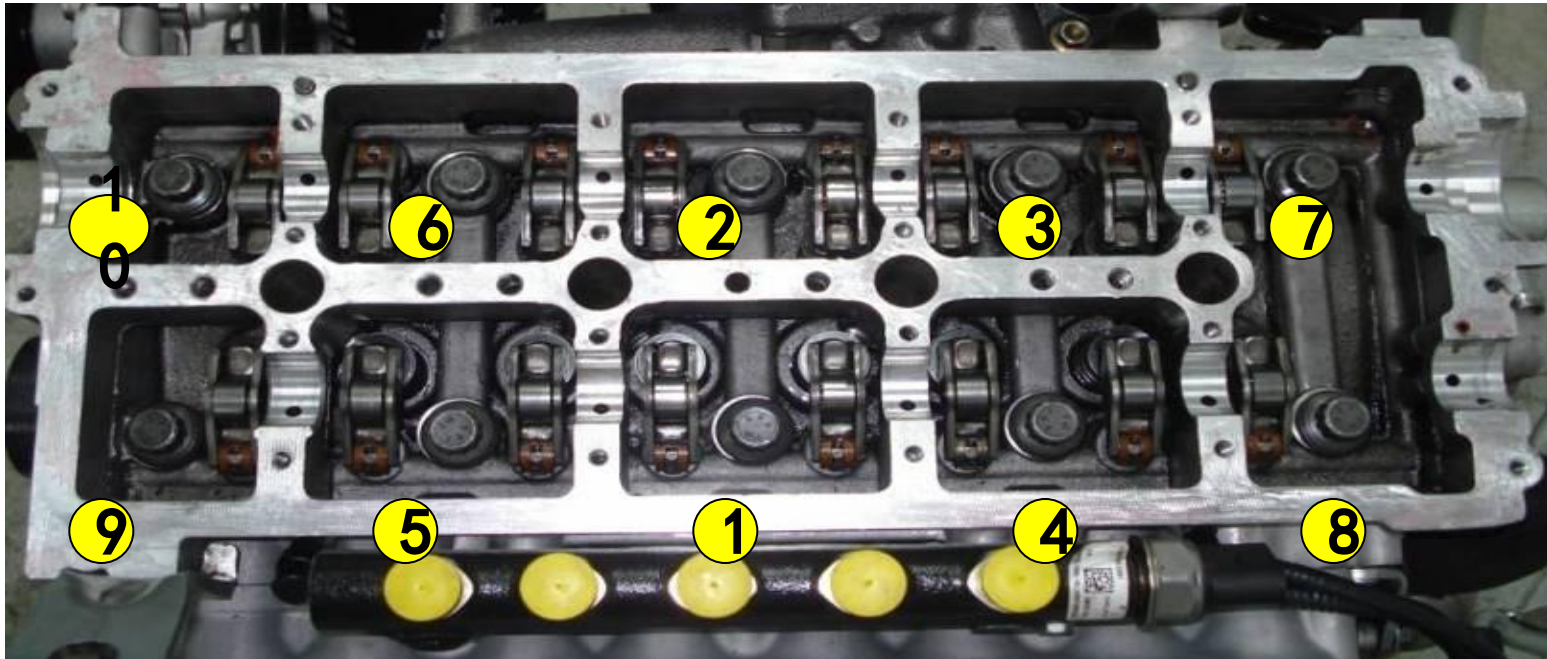

Rear-end

Use the Angle tightening method, screw up by three steps: the first is screw the bolt to $50 \pm N.m$; the second is to turn spanner by 90° ; the third is to turn the spanner by another 120°

5、Screw up the camshaft bearing cover

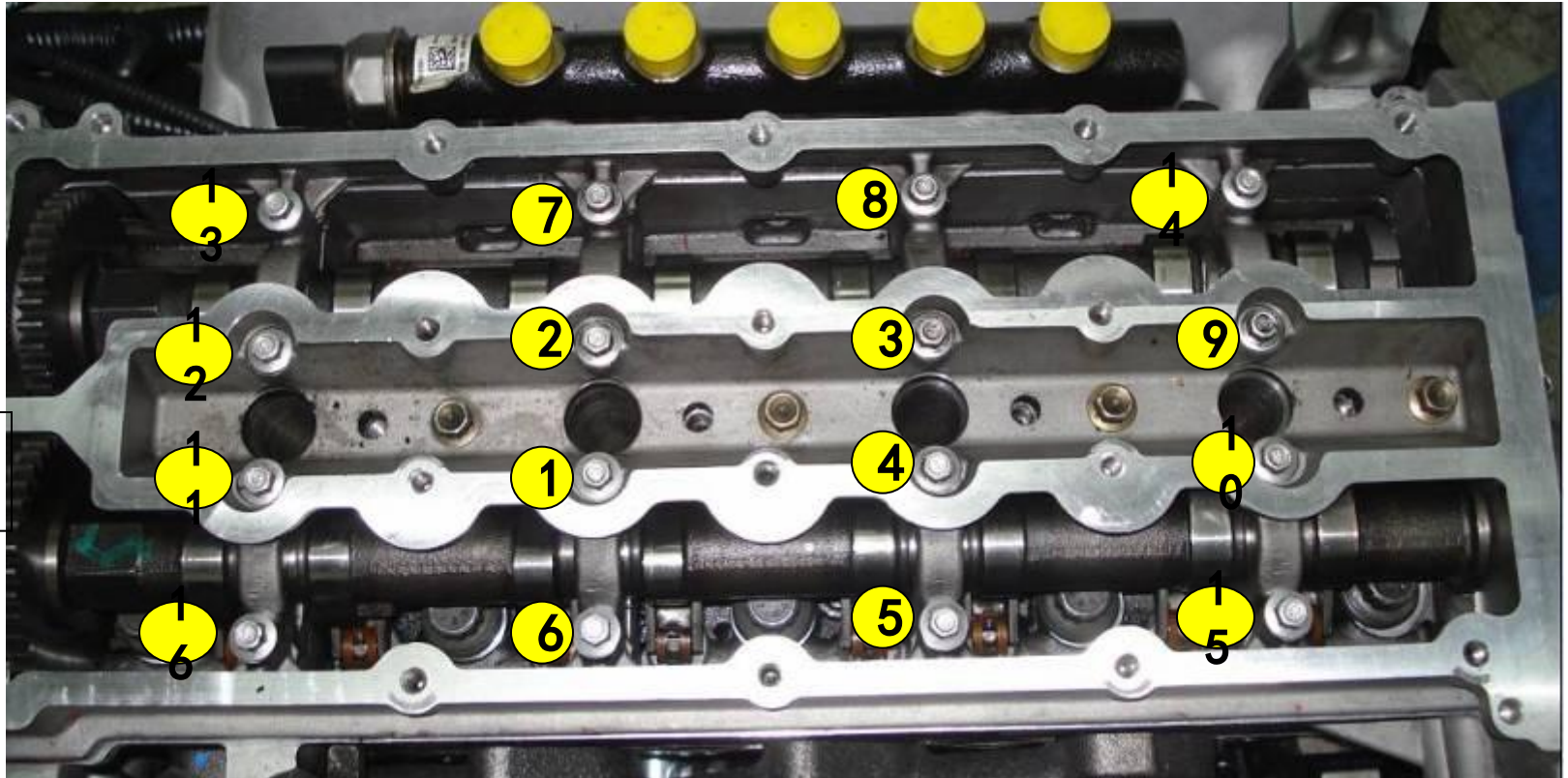

The camshaft cover bolt tightening order is shown as the picture, the torque is: $12 \pm 1 \text{N.m}$

Chapter IV the cylinder block

Cylinder block feature

- The cylinder of GW4D20 adopts the equally split type structure, falls into the upper and lower cylinder block, the lower cylinder and the main bearing cover is formed into one part. In terms of the flat bottom type cylinder block and short skirt cylinder block, this structural design strengthens the structural strength a lot, then engine has enough rigidity when generating explosive pressure and outputting big torque.

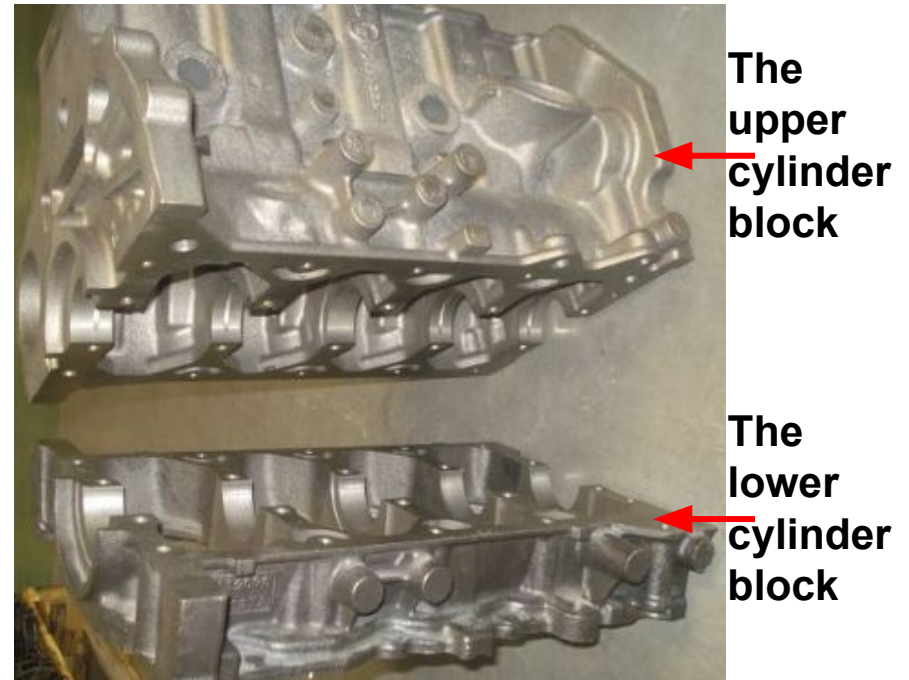

□ Non-liner structure design, compact structure, small cylinder bore deformation, four cooling injectors are installed on upper cylinder block to cooling the pistons to prevent overheating .

Engine code is here

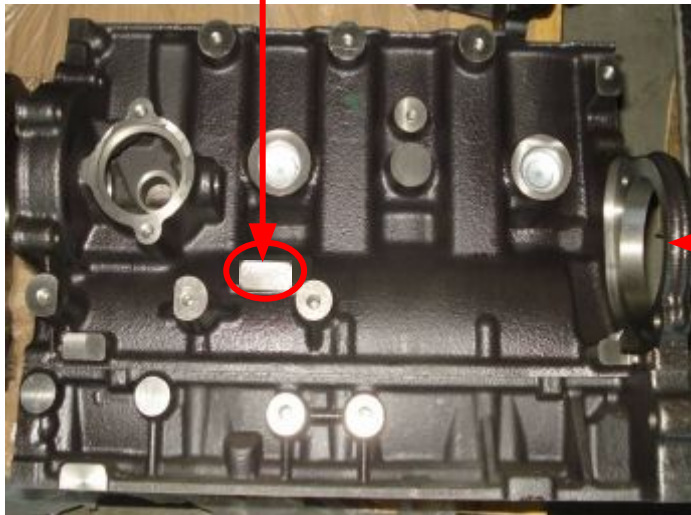

No-liner
 Piston cooling oil passage



Starter location

□ The starter location is directly designed on the cylinder block, at the left side of the engine, the engine code is engraved on left side, on the upper of engine left support, engine code ruling is as follows:

GW4D20

Type code

☆	<u>2010</u>	<u>10</u>	<u>00001</u>	☆
Star No.	Year No.	Mths No.	S/N	Star No.



□Rotor oil pump, oil pump and the cylinder integrated into one part, so the engine structure is more compact.

Oil pump chamber

□The oil filter is installed on the right of the engine, oil filter and the cooler adopts one integrity. Align the locating gap on the cooler with the convex mark on the cooler seat properly.

Oil sensor installation location

Speed sensor installation location

Oil cooler seat

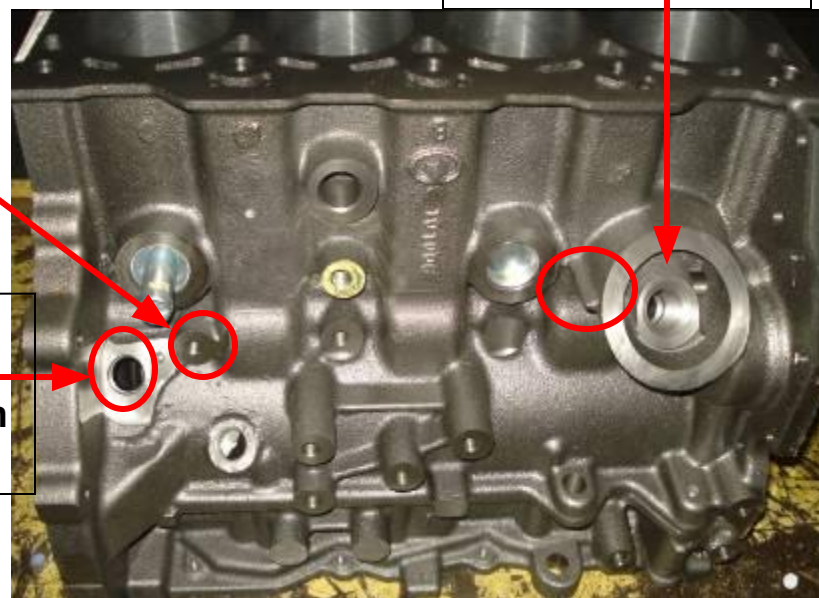

II The cylinder bore and piston's match method

Cylinder block size (Φ /mm)	Mark	Piston grouping (Φ /mm)	Mark	Match cylinder clearance (mm)
83.09~83.10	1	83.1 ^{-0.081} _{-0.090}	1	0.071~0.09
83.10~83.11	2	83.1 ^{-0.071} _{-0.080}	2	0.071~0.09
83.11~83.12	3	83.1 ^{-0.061} _{-0.070}	3	0.071~0.09

Piston grouping

When assembling, piston and cylinder grouping tags must be matched.

Cylinder block size

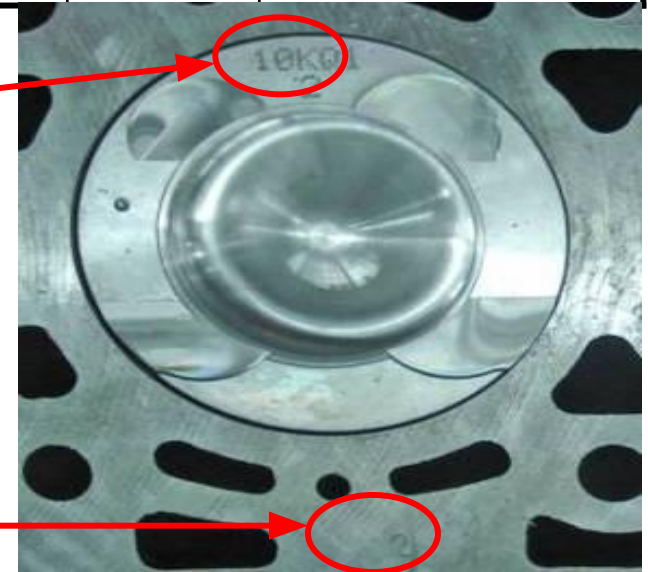

III Match the main shaft bearing

1. The crankshaft main journal is divided into three groups, expressed by “1,2,3”, the mintmark is in the middle of the first crank, as show below in the picture:

Crankshaft main journal size mark



Attention: There are three groups NO. on the first crank, from top to bottom is connecting rod journal NO., crankshaft main journal NO., crankshaft manufacturing NO.

2. The cylinders bore diameter is divided into three groups, expressed by “1, 2, 3”

Marks on the left rear-end of the cylinder block bottom, as the follow picture shows, from left to right, it' s the diameter No. for the 1st to 5th main bearing bores.

cylinder
block main
bearing
bore
diameter
No.



Rear

3. The crankshaft main bearing bearings are divided into three groups, expressed by “yellow colorless and blue”, print on one side of the bearing.

Lower part

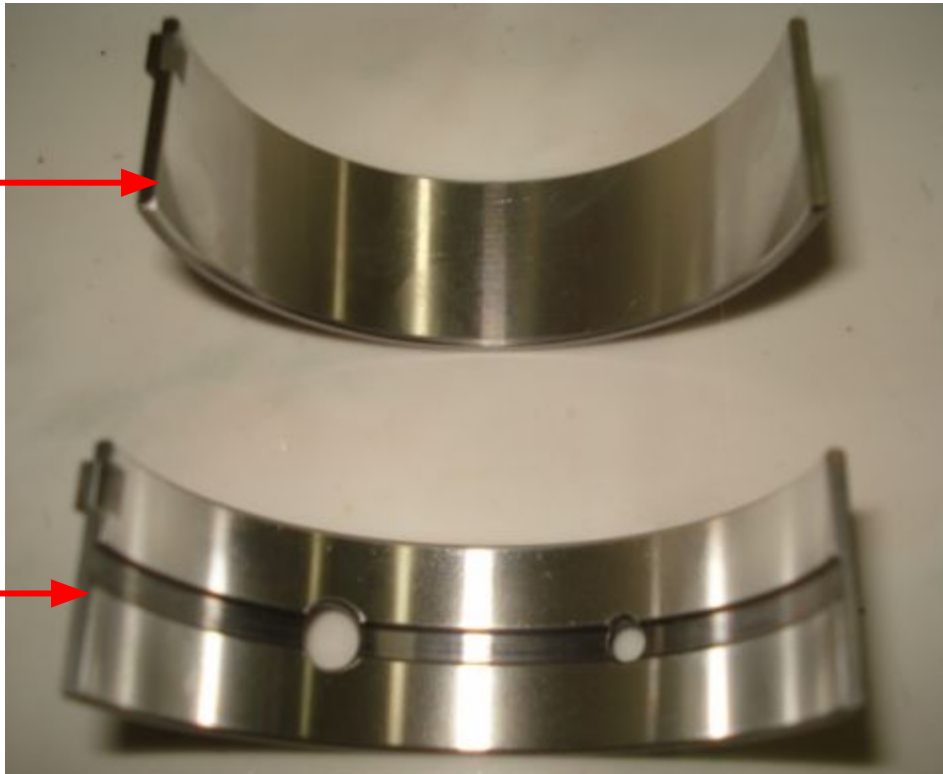

Attention: The upper main bearing has the oil groove and the oil hole, which is installed on the upper cylinder block; the lower main bearing doesn't have the oil groove and oil hole, the two parts can't be installed oppositely.

Upper part

4、The match formula of main bearing

Crankshaft main journal size No.+ cylinder block main journal bore diameter No.	Main bearing color mark	(mm) Fit clearance
=2~3	yellow	0.020~0.046
=4	colorless	0.024~0.044
=5~6	blue	0.022~0.048

Select the main bearing according to the match formula. For example: the first crankshaft main journal size No. is “2”, the first cylinder block bore diameter No. is “1”, $2+1=3$, so choose the “yellow” main bearing.

IV Match the connecting rod bearing

1. The crankshaft rod journal is divided into three groups, expressed by "1,2,3". Marks on the upper end position of first crank of crankshaft, as follow picture shows, from left to right, it's the diameter No. for the 1st to 4th connecting rod journal size.

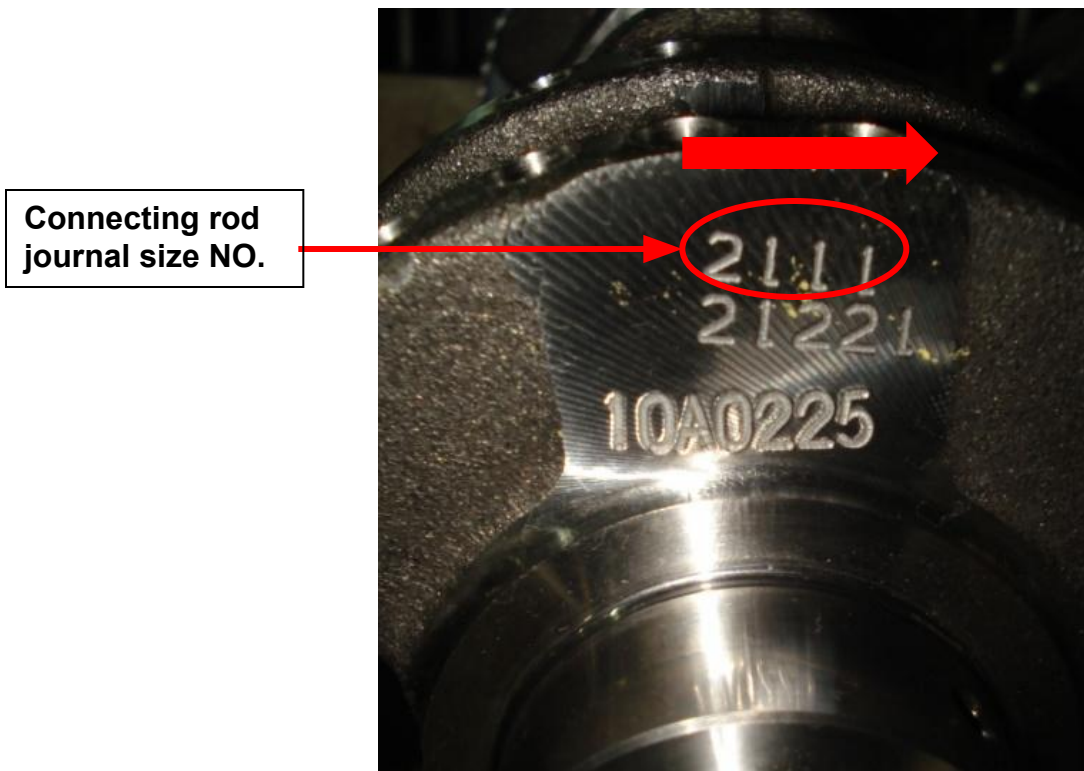

2. The connecting rod big end is divided into three groups, marked on the joint of connecting rod bearing cover, see the picture below

Big end bore diameter No.

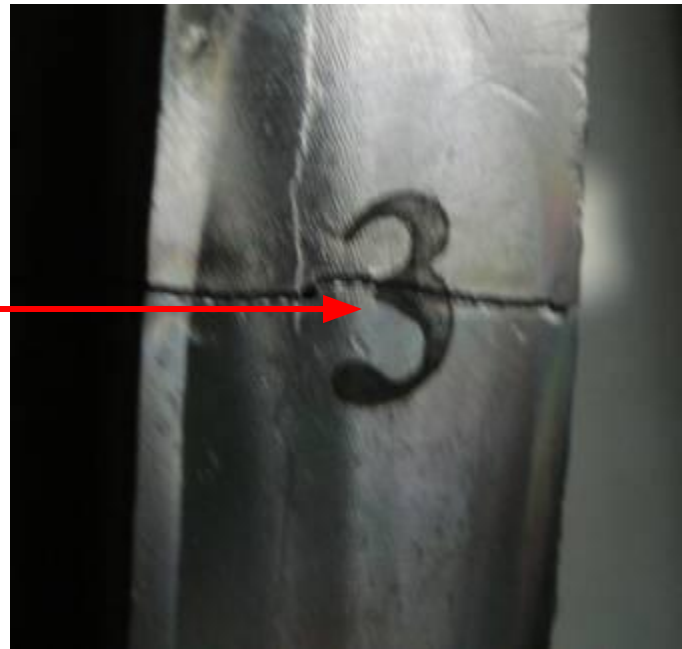

3. The connecting rod bearings are divided into three groups, expressed by “yellow, colorless and blue”, print on one side of the bearing.

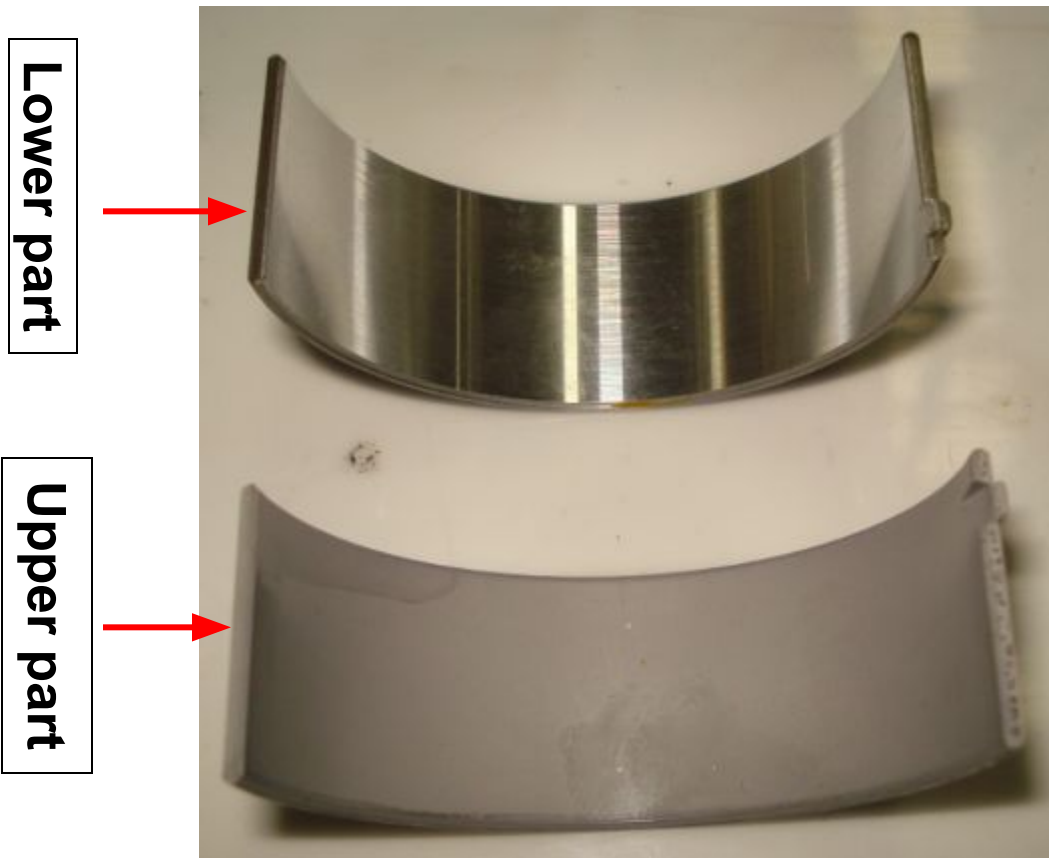

Attention: the upper rod bearing is not smooth surface, the lower rod bearing is smooth surface, there is not oil hole with both of the bearings. They can't install oppositely when assembling.

4、 The match formula of connecting rod bearing

Connecting rod journal size NO. + connecting rod big end bore diameter NO.	Main bearing color mark	(mm) Fit clearance
=2~3	yellow	0.020~0.046
=4	colorless	0.024~0.044
=5~6	blue	0.022~0.048

Select the main bearing according to the match formula. For example: the first connecting rod size NO. is “2”, the first cylinder connecting rod big end bore diameter NO. is “3”, $2+3=5$, so choose the “blue” connecting rod bearing.

V. Notices in installation

1、The notices in installing the piston and connecting rod.

- According to the cylinder bore's grouping mark to choose the corresponding piston.
- The piston and connecting rod shall be assembled according to the forward mark, this means: the top mark of piston, the bulge of connecting rod body and the bulge of connecting rod big end cover side plane should be in the same side, face the front of the engine.



When assembling the piston ring, the first gas ring is silvery white, the second gas ring is dark grey, the two rings can't be exchanged, the upward mark "A TOP" on the ring should face the top of the piston, for avoiding cylinder getting stuck, the opening direction of the rings can't be on the thrust side direction, and the adjacent rings opening shall be staggered by 180 degrees, shows as the picture 2:

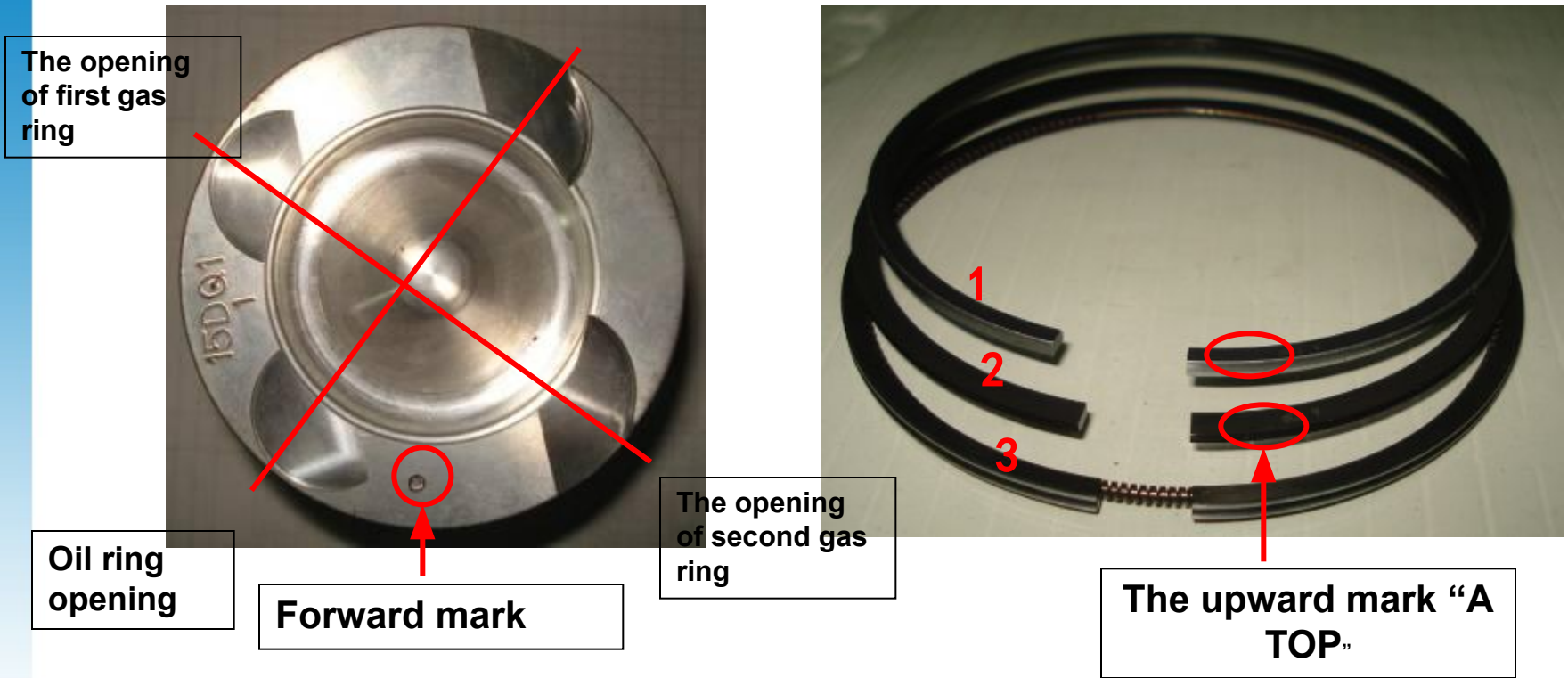

2. The notices in assembling the lower cylinder block

□ apply the glue: before install the lower cylinder block, the jointing surface of lower cylinder block should be coated with loctite 510 anaerobic sealant, the glue line's diameter is 0.8-1.2mm, you must make sure that the coating is uniform and positioned accurately, and avoid squeezed into the main bearing hole;

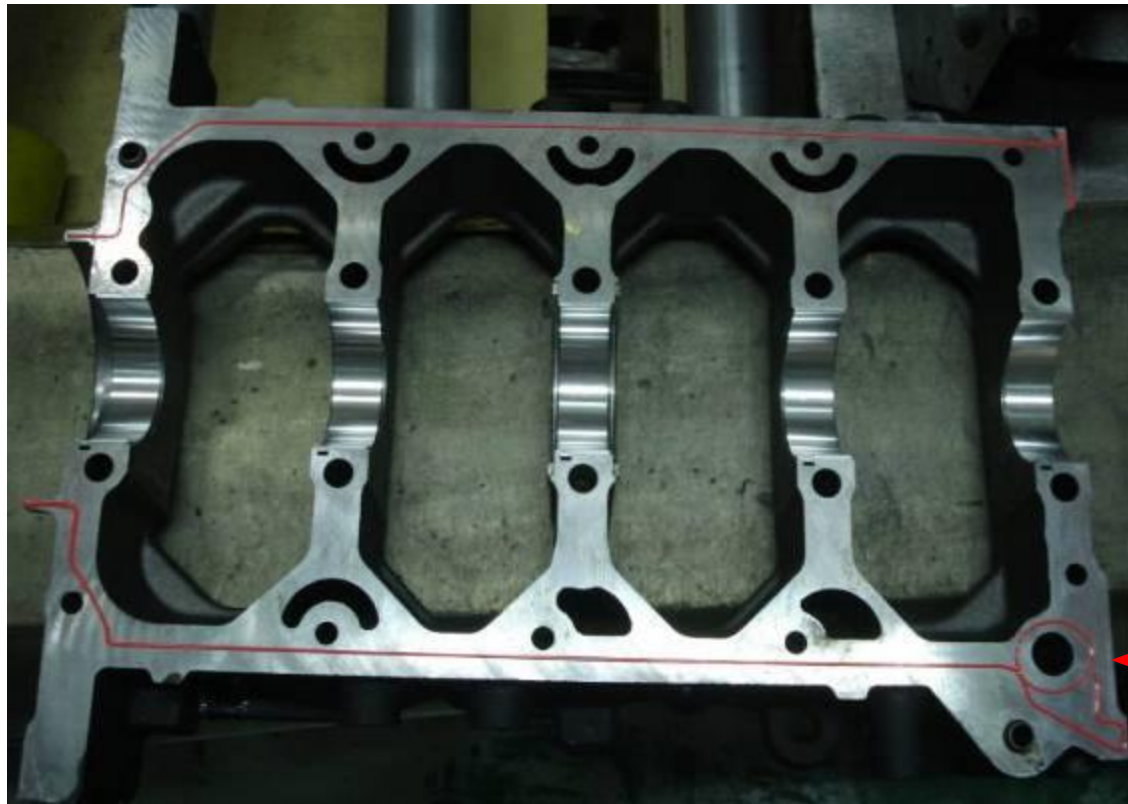

Cylinder
block oil-way

□The fastening and the torque requirement: the lower cylinder block is fastened by 10 main bearing cover bolts and 11 hex flange bolts, The main bearing cover bolts adopt the Angle tightened method, it's divided into three steps: tighten it with the torque as $40\pm 3\text{N.m}$; the second is turn it by 90 degrees., then the third step is turn it another 90 degrees. The torque of the hex flange bolts is: $24\pm 2\text{N.m}$.

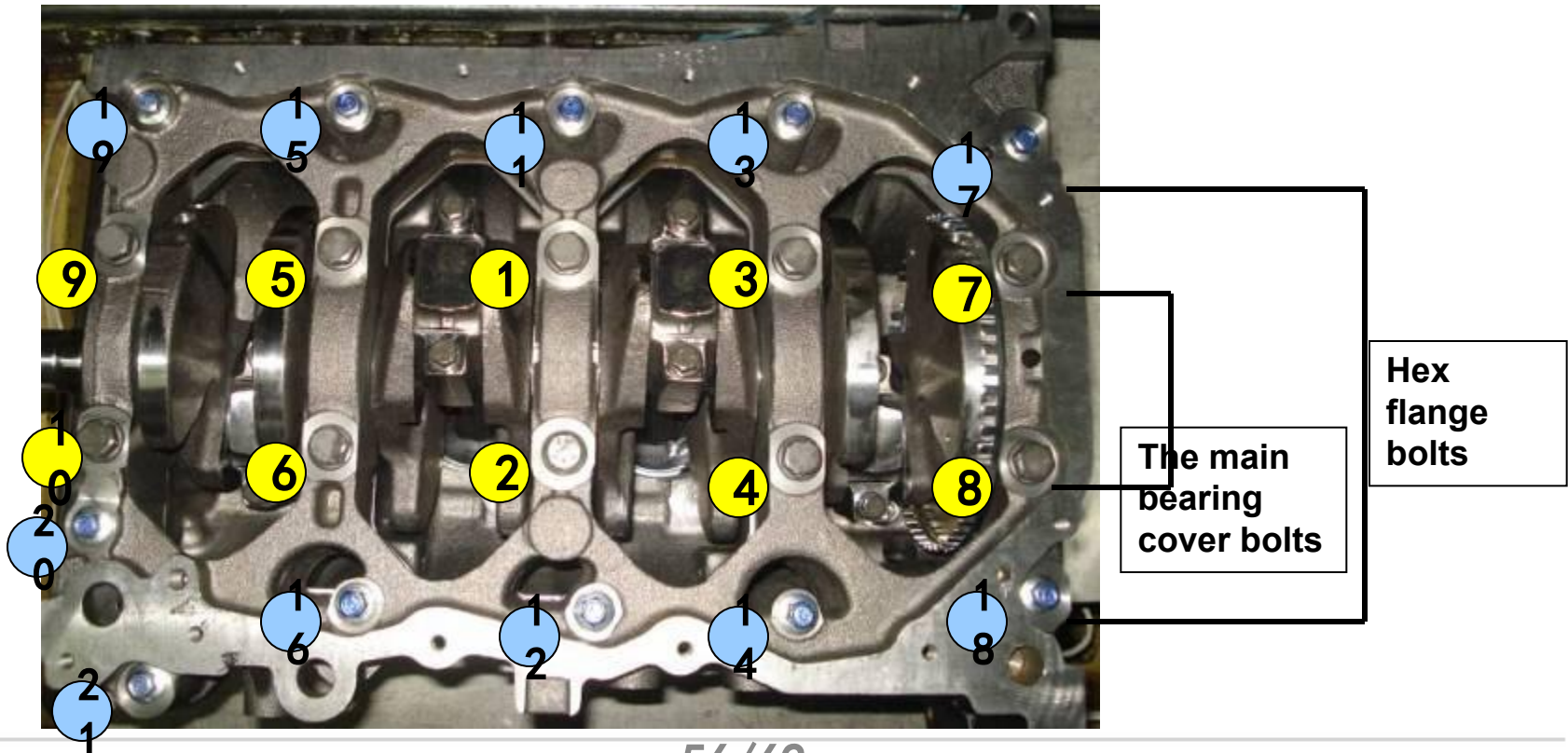

3. The notices in assembling the oil pump

- Clean: clean the joint surface of oil pump, the front oil seal hole of crankshaft, the joint surface of cylinder block and oil pump
- Make sure that the front oil seal of crankshaft and oil pump seal ring assembly are set in place without and deflection, damage and jumping from the slot.
- Coating the glue: coating the 587 sealant as the picture, the diameter is 2-3mm
- Put exterior rotor into the pump chamber on the upper cylinder block, the side with mark of the rotor faces the inside of the pump chamber bottom on the cylinder block.



Glue-coating track

Exterior rotor mark



Course review

1. The overview of GW4D20 diesel engine
2. The Basic parameters of GW4D20 diesel engine
3. The mechanical part of GW4D20 diesel engine