

Modeling of drifting ice cover and processes
of formation of ice loads on marine
engineering structures

Alexander Bekker

Offshore and Structure Mechanics Department

Vladivostok 2018



Content

- Goals and Tasks
- Probabilistic approach
- Extremal analysis
- Non-extreme analysis
- **Ice abrasion problems**
- Ice impact
- Material resistant
- Verification
- Realization

Mathematical modeling of the impact of the drifting ice cover on marine structures

The problem of determining the external ice loads and effects on engineering structures

- It is solved on the basis of theoretical and experimental studies of natural phenomena that cause ice loads and effects, by creating special calculation methods.
- It is in the stage of studying the natural phenomenon - the sea ice cover and its dynamics, the development of models for the formation of external ice loads and impacts.
- It is complicated by the random nature of this phenomenon, a large number of factors and their high degree of spatial and temporal variability.
- High required accuracy of ice loads and impacts on structures.
- The process of interaction of ice cover with MLP has a complex space-time structure and consists of a fairly complex subsystems.

Main Goals and Tasks

GOAL

Improving the reliability of sea ice-resistant structures by improving methods for calculating the probability characteristics of ice loads and effects.

MAIN Tasks

1. Development of mathematical models to describe the dynamics of the Ice Cover, taking into account the space-time variability for the entire life cycle of structures.
2. The development of Mathematics Models of Ice Loads and Influences formation for the all Life Cycle Period of Structures with Stochastic approach.
3. The Development of the Ice Field-Cylindrical Structure Interaction Mathematics Model
4. The Development of the Ice Hummocks - Cylindrical Structure Interaction Mathematics Model

Total Approach

- Ice Regime is Characterized by the Combination of the Follow Parameters: Ice Thickness, Drift Velocity, Ice Strength, Ice Fields Sizes, Concentration, etc.
- Ice Regime Parameters can be presented by a Random Variables or Functions Random Variable.
- The Parameters of Marine Structure Loading Regime are a Random Variables or Functions Random Variable.
- Really Under The Stochastic Approach The Combination of Possible Marine Structure Exploitation Regimes are Determinate.
- To determine the reliability of the structure in case of a sudden failure, ice extremal loads must be taken.
- For the Determination of Structure Reliability on the Gradual Failare (Fatigue, Abrasion, Corrosion) Ice Load Regime on full Exploitation Period Must be Taken.

General view of the dependence of the ice load from the parameters of the ice regime

$$y = \Phi(x) \quad (1)$$

where Y – Outcome Parameter (Ice Load); X – Multidimensional Vector of Ice Regime Parameters; Φ – Operator.

THE FUNCTION OF THE DISTRIBUTION OF ICE LOADS

$$\Phi(y) = P(y < y_0) = \int_{\Phi(x) < y_0} f(x) dx, \quad (2)$$

Where y_0 – Value of y, Which Cannot be Over With Given Probability P;

$f(x)$ – Density of Joint Distribution x.

$$\text{ICE LOAD } y = \Phi(h, R, V, N, D), \quad (3)$$

ICE LOAD DISTRIBUTION FUNCTION

$$F(y_0) = P[\Phi(h, R, V, N, D)] = \iiint \iiint f(h, R, V, N, D) dR dV dN dD \quad (4)$$

FOR DECISION OF PRESENTED TASK IT IS NECESSARY

- Define in clear form the distribution function;
- have a method of solving the integral (4).

Mathematical approach for ice cover description

1. The Taking Account of Changeable of Ice Loads is Realized in Three Time Scales: “Large” – Multiyear; “Overage” – Seasonal; “Small” – at Contact Ice-Structure Interaction.
2. Ice Cover is Divided Conditionally on two Components: Level Ice Fields and Large Ice Features (Giant Fields, Hummocky ice fields, hummocks etc.)
3. To determine the stochastic distribution of ice loads in the calculation of the probability of gradual failure of marine structures is taken into account smooth ice fields.
4. Large Ice Features Take Account for Determination Stochastic Distribution of Ice Loads for the Calculation Structure Sudden Failure Probability.

Probabilistic Imitation Model of Ice Loads Formation

Main Assumptions

1. Ice Cover is the Ice Features Combination, Uniformly Distributed on Water Area With Thickness h , Diameter D , Concentration N , Drift Velocity V .
2. Ice Cover Parameters are the Independent random variables.
3. To calculate the loads and impacts on the sea structure, the calculated combinations with the determined values of the ice regime parameters are formed.
4. The time of existence of the calculation Situation is calculated on formula:

$$t_k = P(V_k) \cdot P(D_k) \cdot P(h_k) \cdot P(t_k) \cdot P(N_k) \cdot P(Z_k) \cdot t_s$$

5. The time of existence of the calculated situation, taking into account the probability of contact of the ice formation with the sea structure, is determined by the formula:

$$t_c = t_k \frac{N}{10 \cdot D_k^2} (D_k + D) \cdot (L_0 + D)$$



PROBABILISTIC approach to modeling of ice loads

Extreme loads:

- Extreme sizes ice floes
- Hummocks
- Icebergs
- Combinations

Non-Extreme effects:

- Fatigue
- Abrasion
- Corrosion
- Combinations

EXTREMAL ANALYSIS

The purpose of the analysis - to determine the **maximum possible design ice load**

In general, all ice impacts on marine structures can be divided into several designing categories depending on the period of repeatability:





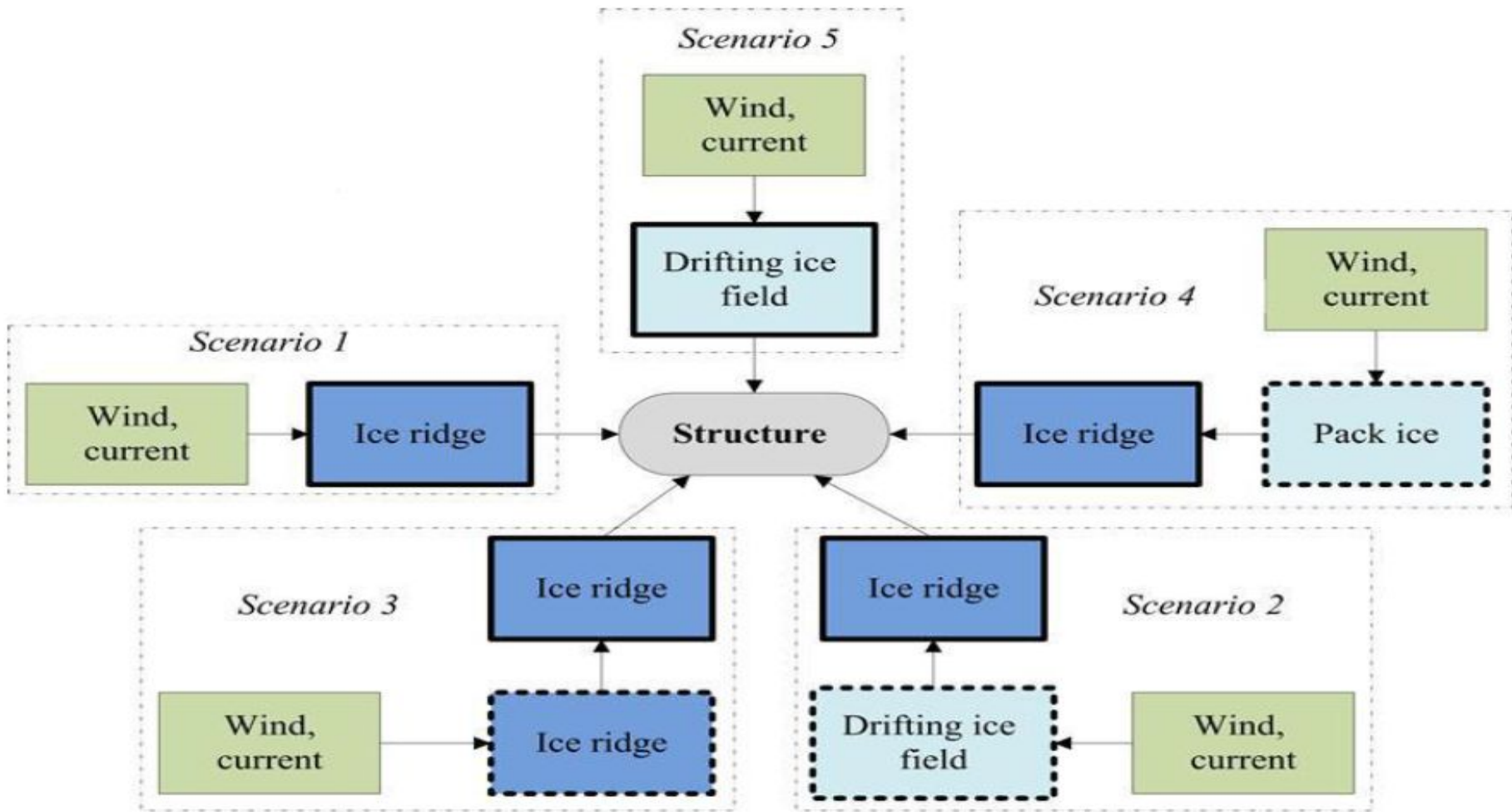

- ice usual or extreme impacts with period of repeatability once in a hundred years (level and hummocky fields, hummocks);
- ice abnormal impacts with period of repeatability a thousand years and more (large/giant ice formations);
- background ice loads determined as average for the ice period to be considered in possible combination with seismic load (level and hummocky fields, hummocks);
- dynamic loads, determined as maximum expected for the whole life cycle (level and Hummocky fields).

Possible scenarios of interaction between an ice cover and structure

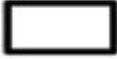
1. “Ridge – structure” interaction - a physical model of a total destruction of an Ridge (Scenario 1);
2. “Ridge – structure” interaction - an energetic model of the partial failure of Ridge (Scenario 1’);
3. Total Load from currents and wind on the ice formation which has stopped in front of a structure. In this case the realization of following designing scenarios is possible:
 - the Ridge which has stopped in front of a structure, is impacted by the drifting ice fields of various sizes and concentration (Scenario 2),
 - “structure – stopped ice formation” system is impacted by external loads from wind and current (Scenario 3),
 - the Ridge which has stopped in front of a structure, is impacted by the pack ice (Scenario 4),
4. Interaction between a large/giant ice field of rare probability of occurrence and a structure (Scenario 5).

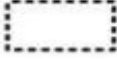

Legend

- | | | | |
|---|---------------------------------|---|-----------------------------------|
|  | - load on structure's contact |  | - ice ridges |
|  | - load on ice feature's contact |  | - ice fields |
|  | - wind and current loads |  | - wind and current driving forces |

Algorithm steps and numerical realization of model

When developing the algorithm of probabilistic modeling of ice – structure interaction, the following assumptions were accepted.

1. The ice cover is represented as a stochastic flow with random combination of ice ridges and ice fields, uniformly distributed over the water area.
2. The ice ridge with the random geometric, kinematic and strength parameters approaches the structure with vertical shape, stops in front of it and refreezes.
3. The ice ridge which had stopped in front of the structure is affected by the level ice fields of various sizes and concentration.
4. The ice ridge is characterized by the probabilistic parameters: a sail height, drift velocity, strength of the consolidated part, sizes, strength parameters of a keel and a sail.

Algorithm steps and numerical realization of model

5. Ice fields are defined by the probabilistic parameters: ice field thickness h , general drift velocity \mathbf{V} , size of ice fields \mathbf{D} , and ice strength \mathbf{R} .
6. The parameters of the ice regime are random values and have been represented as histograms obtained from field observations in water area of oil&gas deposit. The limits of the existing parameters of an ice cover are restricted by the values of actual full-scale data.
7. The deterministic (non-stochastic) parameters are the parameters of structure (size, width, water depth, etc.) and the physical properties of an ice cover (e.g., density, salinity, etc.).
8. Supposed hit of an ice ridge with a structure and stopped ridge with an ice field ice is determined according to a “rain drop” model. In the probabilistic scenario ice hit is considered as a random event.

The generation scheme of random parameters of ice regime by Monte-Carlo method

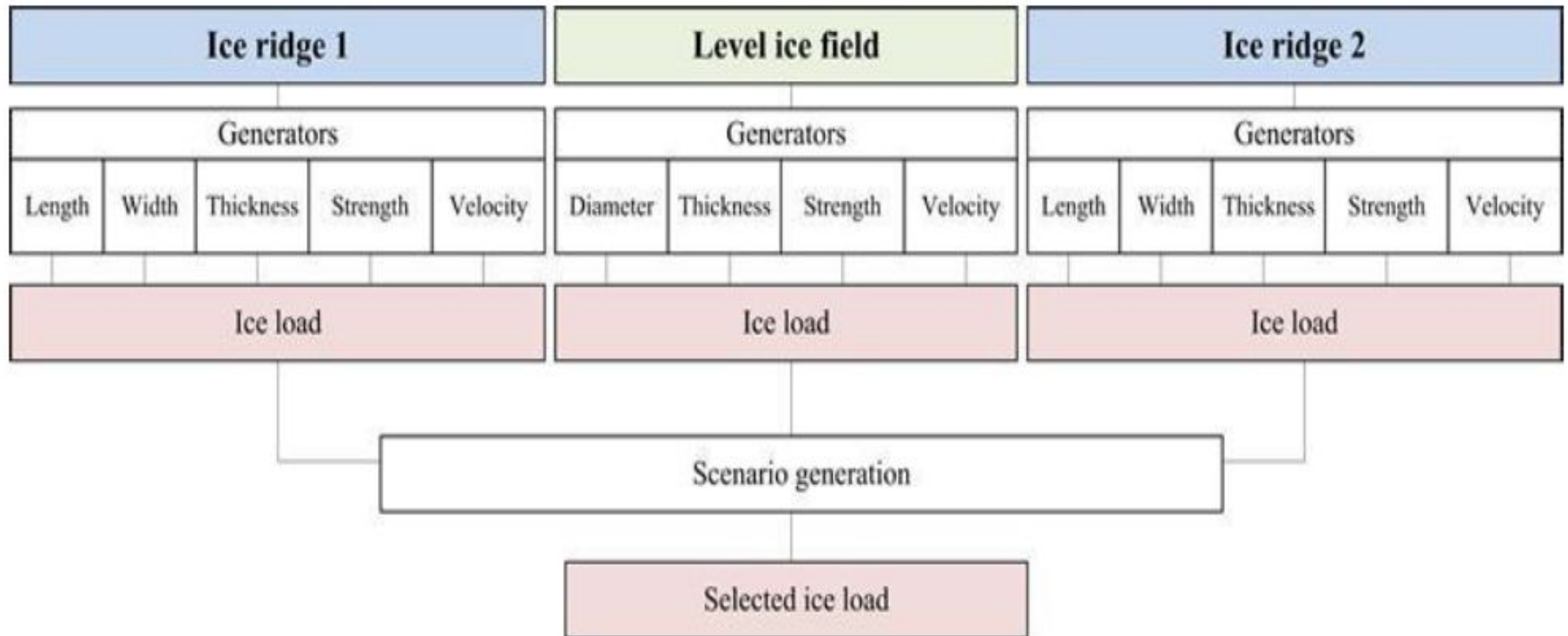

CALCULATION EXAMPLE

(Bekker, Sabodash, Kovalenko OMAE 2013)

Input Data Analysis:

Ice conditions. The ice regime to the north-east **offshore Sakhalin** is very severe in the southern part of the Sea of Okhotsk. In extreme winters the maximum values of an ice thickness are about 90÷160 cm, peak values of the ice drift velocity are about 74÷110cm/s, moreover the specificity of ice drift is reversing nature near the area of oil&gas deposits.

Statistical characteristics of variability of parameters of an ice cover for the **Piltun-Astokhscoe** oil&gas deposit were taken from full-scale data obtained from various research programs in 1989-2002. Numerical simulation of design values of ice parameters was made by Monte-Carlo method.

This area is characterized by the permanent ice cover deformation followed by hummocking and continuous failure of the ice fields. The heights of ridge's sails in some areas are about 1.5 - 3.0 m, the keel width is 60 m, and the maximum keel depth is 20-25 m.

Calculation example

Structure

The “Molikpaq” offshore platform (PA-A) was installed during Phase 1 in 1998.

“Molikpaq” is a converted ice-class drilling rig, previously based in the Beaufort Sea.

The characteristics of the structure are: 111m × 111m base, 37,523 t weight, and 30m water depth.

Design global ice load is equal 640 MN, including the local ice pressure 3.0 MPa.

Histogram of ice loads for “structure - ice ridge - ice field” scenario (Scenario 2)

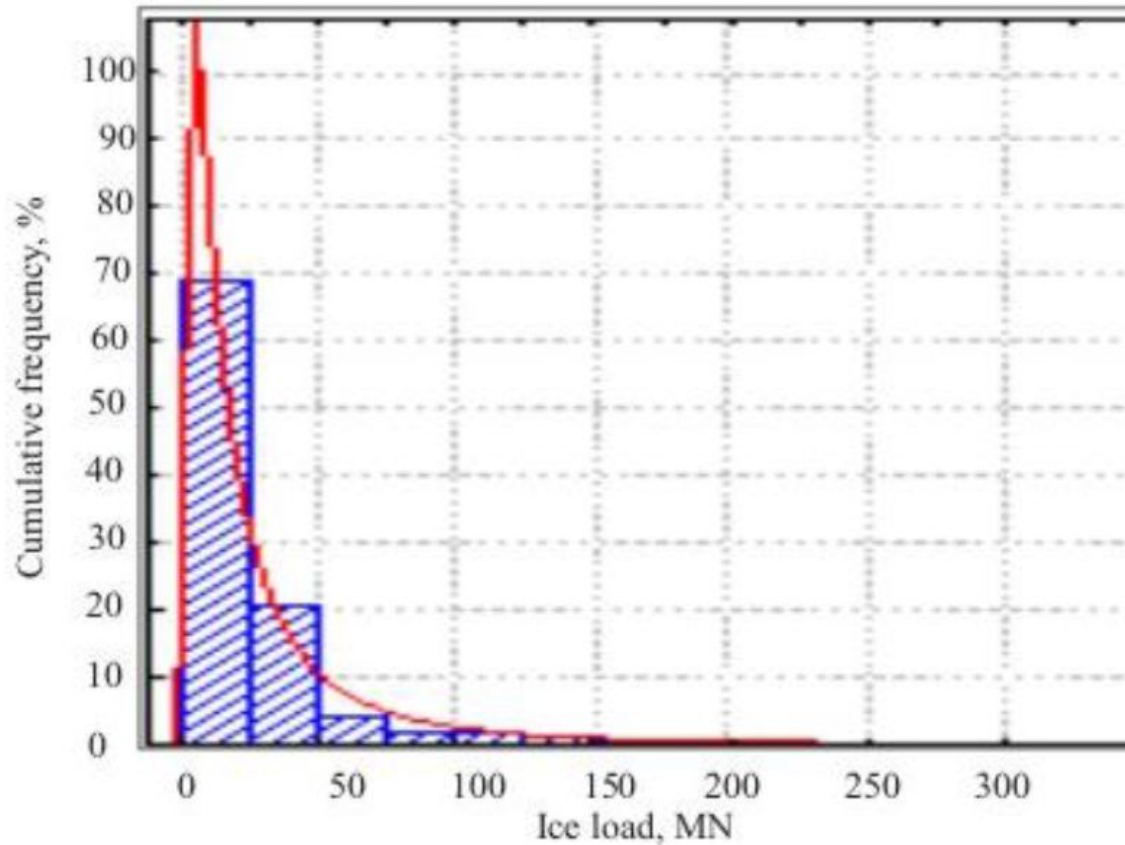

Cumulative frequency function of distribution of ice load on the probability paper of exponential distribution for 1989-2002 (Scenario 2)

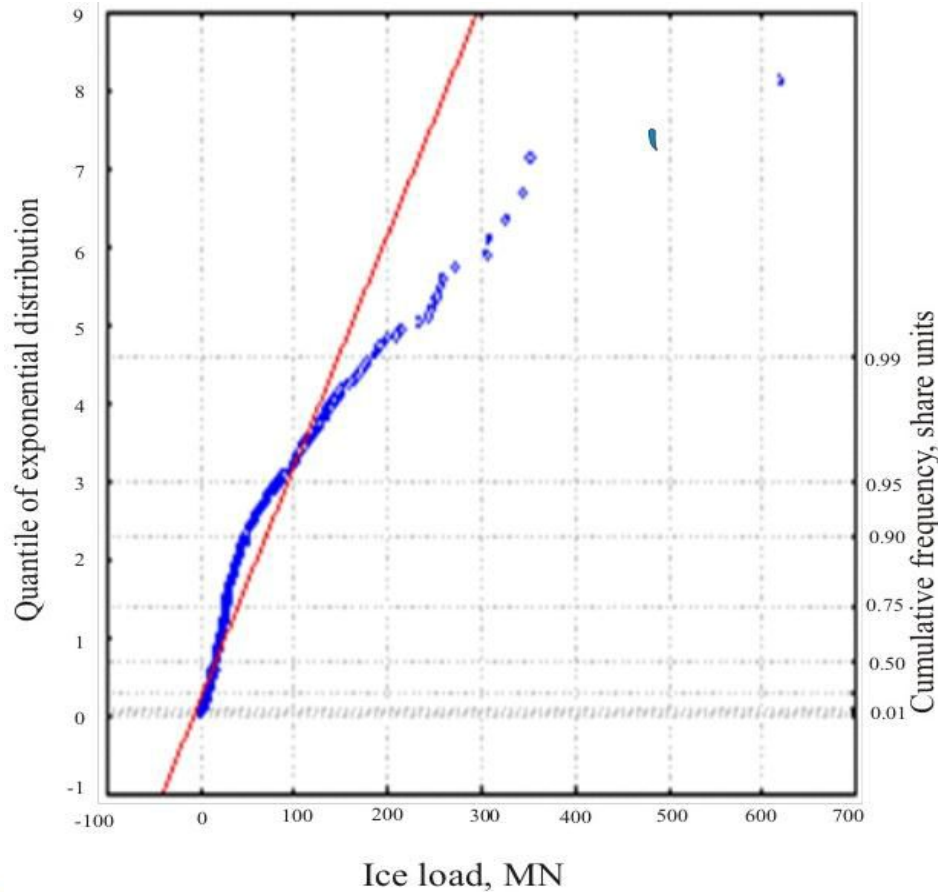

Verification - ?

NON-EXTREME ANALYSIS

(Fatigue, Abrasion, Corrosion)

Abrasion Actions of Drifting Ice Cover on Marine Engineering Structures

Ice Abrasion

This is the effect of drifting ice formations on the structure, causing the destruction of the surface of the structure material

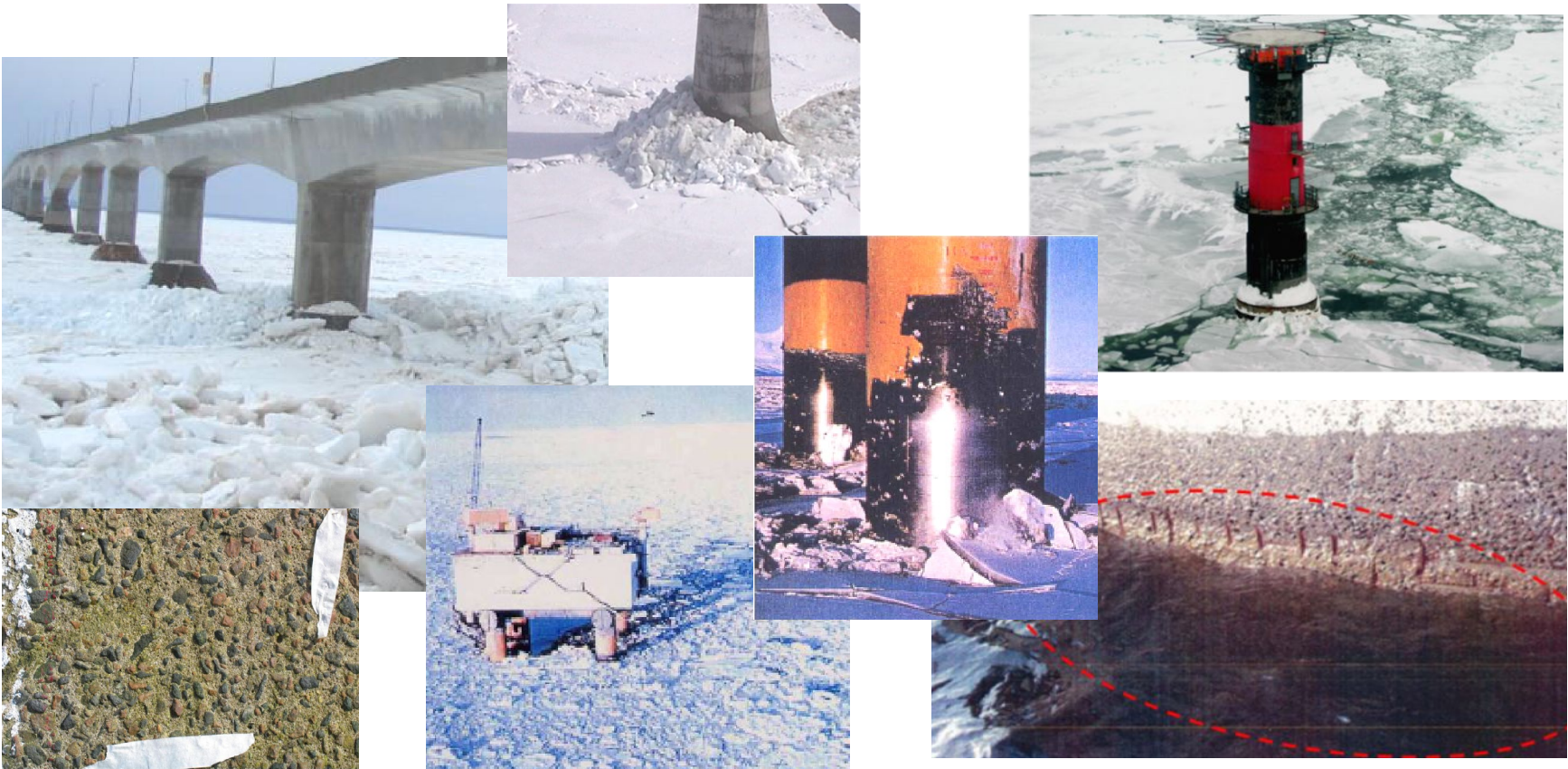

The Concept calculation of depth of abrasion of construction materials by Ice

ICE ABRASION CALCULATION

**Impact on
structure**

**Resistance of
the material**

Experimental
studies

**Theoretical
studies**

**Experimental
studies**

Theoretical
studies

The main factors affecting the depth of ice abrasion



- **The intensity of the contact pressure;**
- **Length of interaction path (abrasion);**
- **Ice strength and temperature;**
- **Velocity of interaction;**
- **Resistance of the material to ice abrasion.**





Ice Impact on Structure

(Ice contact pressure)



Probabilistic Imitation Model of Ice Loads Formation

Main Assumptions

1. Ice Cover is the Ice Features Combination, Uniformly Distributed on Water Area With Thickness h , Diameter D , Concentration N , Drift Velocity V .
2. Ice Cover Parameters are the Independent random variables.
3. To calculate the loads and impacts on the sea structure, the calculated combinations with the determined values of the ice regime parameters are formed.
4. The time of existence of the calculation Situation is calculated on formula:

$$t_k = P(V_k) \cdot P(D_k) \cdot P(h_k) \cdot P(t_k) \cdot P(N_k) \cdot P(Z_k) \cdot t_s$$

5. The time of existence of the calculated situation, taking into account the probability of contact of the ice formation with the sea structure, is determined by the formula:

$$t_c = t_k \frac{N}{10 \cdot D_k^2} (D_k + D) \cdot (L_0 + D)$$

Additional assumption

6) For proper calculation of ice loads, three basic groups of probable effects by drifting ice on supports of marine structures are specified depending on dimensions of ice formations:

- load by broken ice with dimensions up to ($D_k \leq 4d$, where D_k - diameter of ice formation, d – diameter of marine structure's support)
- load by ice floes with dimensions up to ($4d < D_k \leq 500\text{m}$);
- load by ice fields ($D_k > 500\text{m}$);

Additional assumption

7) The destruction of ice field of h thickness at interface with GBS occurs by bilateral shear of triangular prisms. Shear angle β is defined by Coulomb-Mohr limit equilibrium theory (Bekker, 1998). The second and following shear are happened when vertical size of contact zone is equal:

$$h_1 = \frac{h}{a \sqrt[4]{\dot{\epsilon}}}$$

where h is sheet ice thickness, m;

$\dot{\epsilon}$ is ice relative strain rate, s^{-1} ;

a is empirical coefficient.

Destruction by bilateral shear of triangular prisms
at contact of system of "ice-structure"

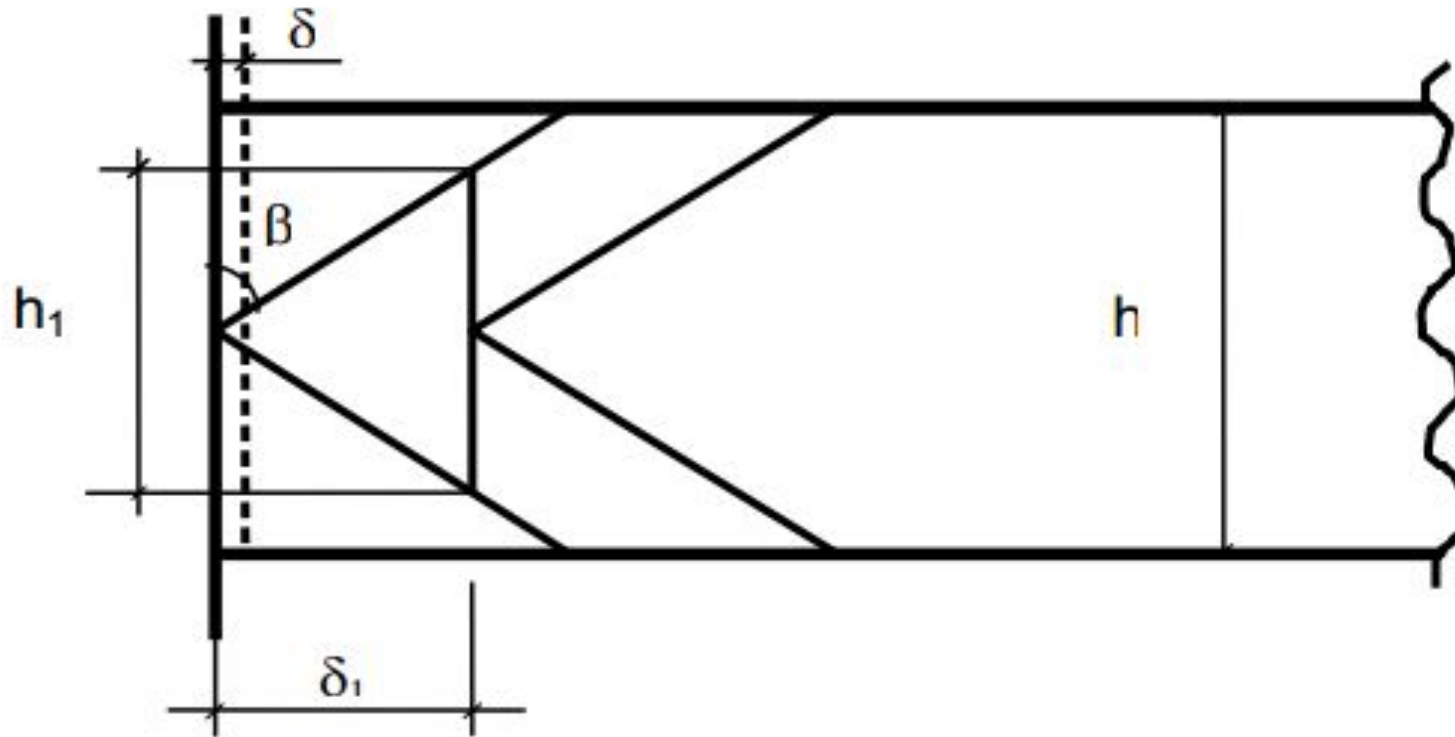

Mathematical Models

Models developed to implement the general probability model for calculation of GBS depth of abrasion are as follows:

- mathematical model of mechanical interaction of ice fields with structure;
- mathematical simulation model of ice force formation and calculation of abrasion path from ice fields;
- mathematical simulation model of ice force formation and calculation of abrasion path from ice floes;
- mathematical simulation model of ice force formation and calculation of abrasion path from broken ice;
- mathematical model of abrasion depth calculation.

Hierarchy of mathematical models for calculation on the Gradual Failure

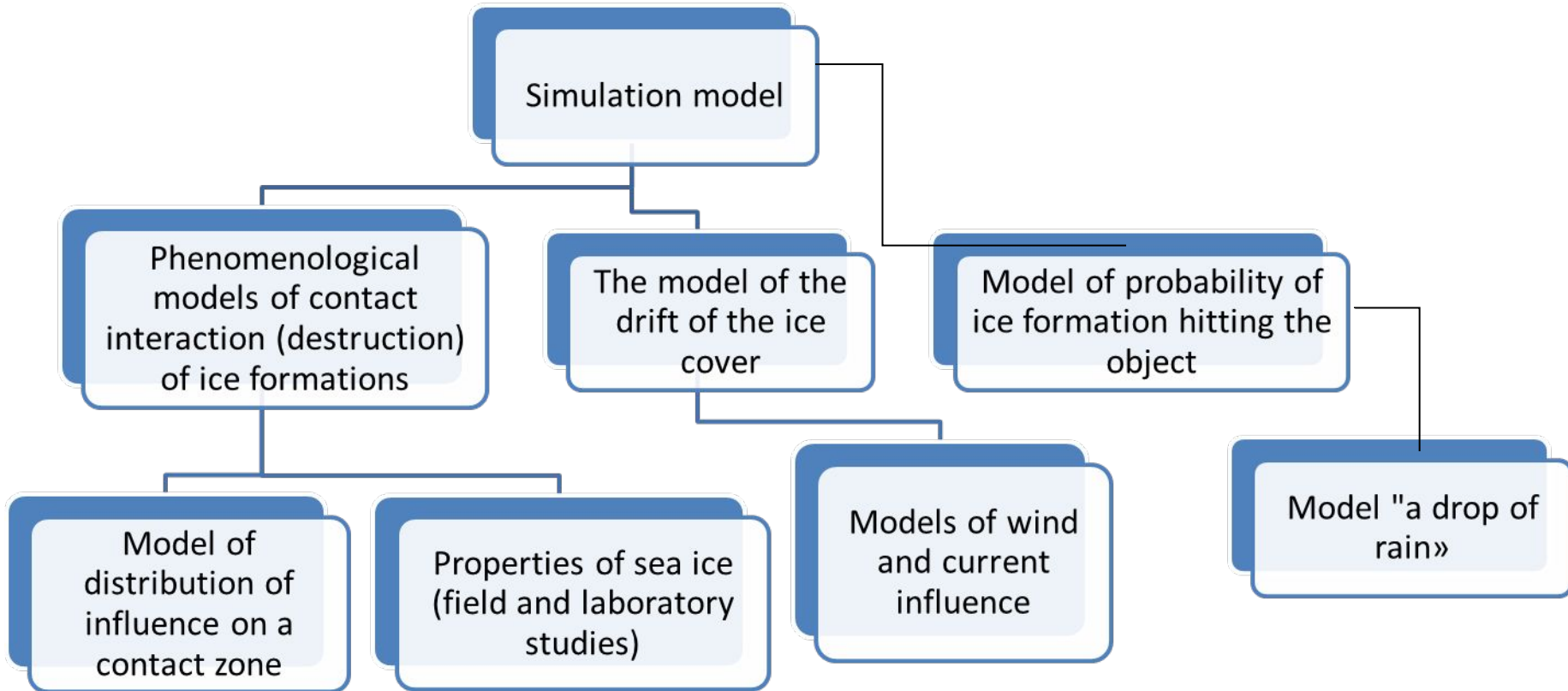

Modeling of ice properties

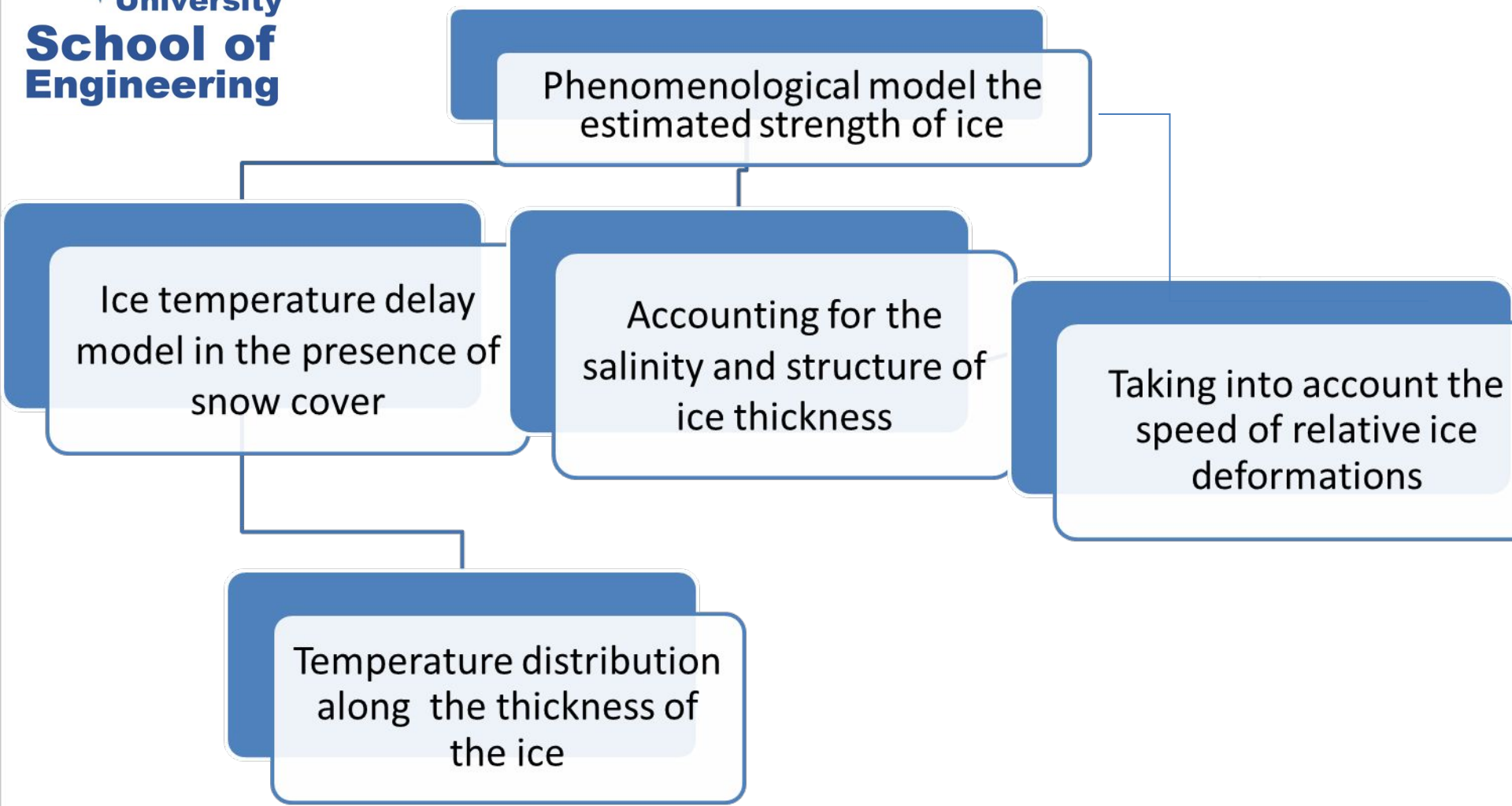



Typical cases of “ice field-marine structure” interaction are as follows:

- B.** Penetration of structure’s supports into the ice field;
 - B.1** Penetration of the ice block, slowdown before the structure;
 - B.2** Penetration of the ice block with subsequent acceleration caused by another ice floe impact impulse;
 - B.3** Penetration of the ice block and shear of ice floe adjacent to structure;
- C.** Stand-still of the ice field before the structure;
 - C.1** Stand-still of the ice block and velocity slowdown;
 - C.2** Stand-still of the ice block with subsequent moving-off caused by another ice floe impact impulse;
- D.** Ice block buckling failure.
- E.** Open water in front of structure.

Simulation modeling

The simulation model of the drifting ice cover and its effects on structure, designed to determine the various characteristics of the interaction of the ice cover and structures, based on numerical simulation of the distribution functions of the ice regime parameters and simulate all possible situations characterized by a random combination of values of these parameters.

For each situation, a deterministic calculation of the ice load is performed, using specially designed mathematical models.

One group of models describes the process of mechanical interaction between ice fields and structure, and the other describes the process of destruction of ice fields in contact with the structure and the formation of ice load.

As a result of the “run” of all calculated situations during the operation of the construction, we obtain the probability distributions of ice loads and their parameters

Mathematical model of formation of ice loads and impacts (ice fields)

$$F_{bp} = mk_b k_v dR_k h_1 \quad F_p = n_t k_1 k_2 F_{bp} \quad \int_0^X F_i \Delta x_i = \frac{M_{i+1} V_{i+1}^2}{2} - \frac{M_i V_i^2}{2}$$

$$V_{i+1} = \sqrt{\frac{M_i V_i^2 + 2(F_i - F_w) \cdot V_i \Delta t}{M_{i+1}}}$$

$$V_{i+1} = \frac{M_i V_i + M_0 V_k}{M_i + M_0}$$

$$\Delta x_i = V_i \cdot \Delta t$$

$$X_i = \sum \Delta x_i$$

$$d_k = \pi \frac{d}{2}$$

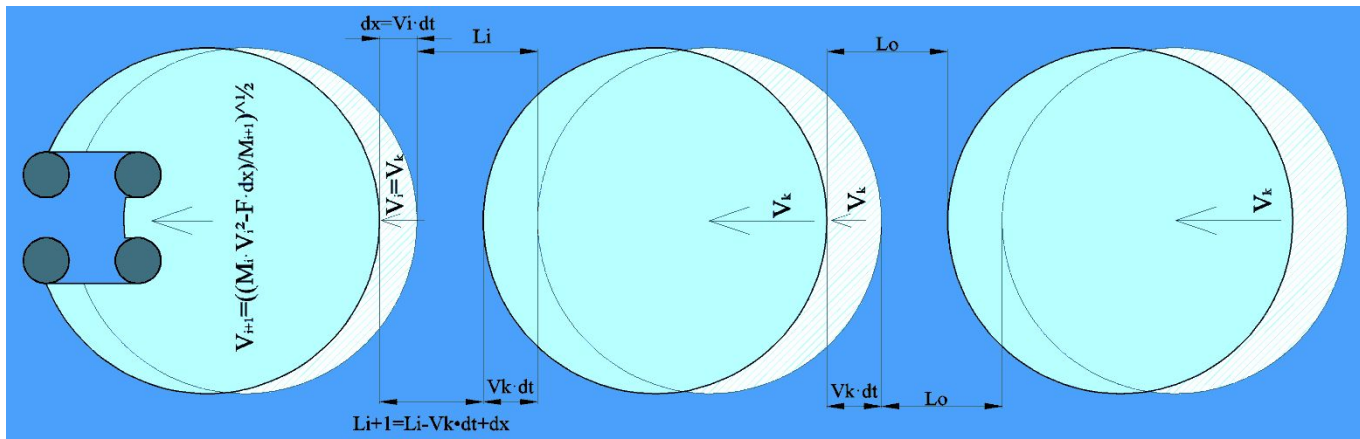

A possible scenario of interaction



Mathematical model of formation of ice loads and impacts (fragments of ice fields)

$$F_{bp} = m k_b k_v d R_k h_1 \quad F_p = n_t k_1 k_2 F_{bp}$$

$$N > 9 \quad X = V_k t_c$$

$$d_k = \frac{d}{2} \arccos\left(\frac{1}{2}\right)$$

$$N < 9 \quad X = k_t V_k t_c$$

$$k_t = \frac{d_{rb}}{D_k + L_0 - d_{rb}}$$

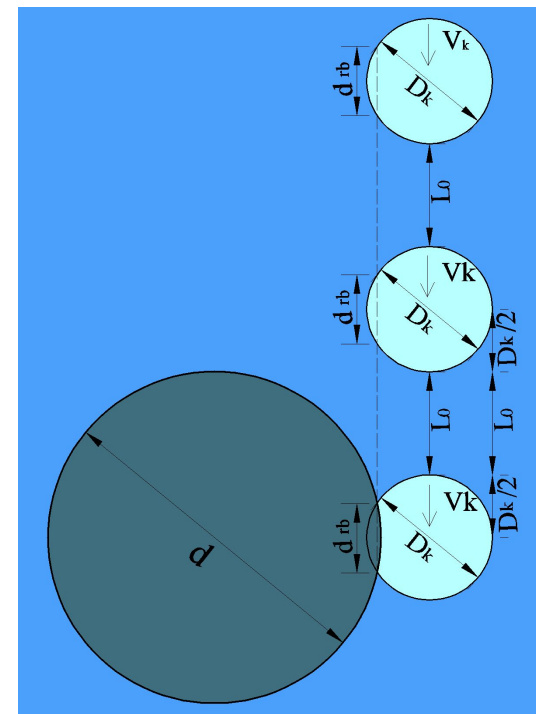
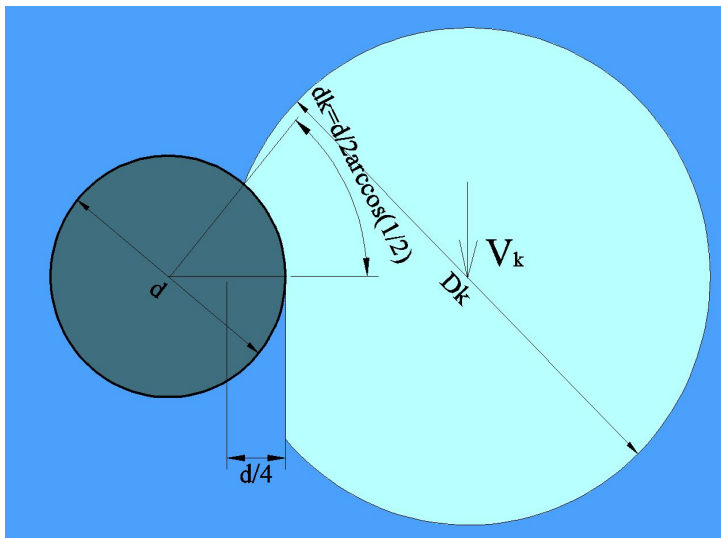

A possible scenario of interaction



IceStrIn
v1.0

Mathematical model of formation of ice loads and impacts (broken ice)

$$F_{bp} = mk_b k_v d R_k h_1 \quad F_{cp} = 0,04 V_i h_1 \sqrt{m A k_b k_v R_k \tan \gamma}$$

$$F_{\beta} = \frac{M_0 V_k^2}{L_0} \cdot \frac{2\varphi}{\pi} \cdot (1 - \cos(\varphi))$$

$$N < 9 \quad X = k_t V_k t_c$$

$$k_t = \frac{d_{rb}}{D_k + L_0 - d_{rb}}$$

$$d_k = d \cdot \arctan\left(\frac{d_{rb}}{d}\right)$$

$$N > 9$$

$$\sigma_p = 2C \tan(\pi / 4 + \varphi_{ice} / 2)$$

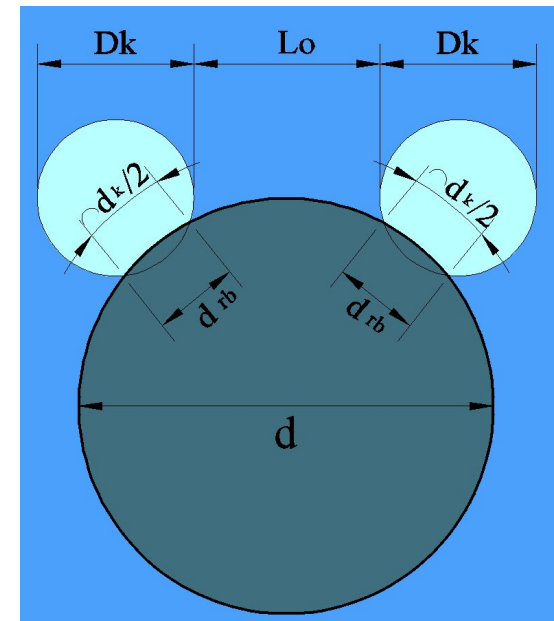
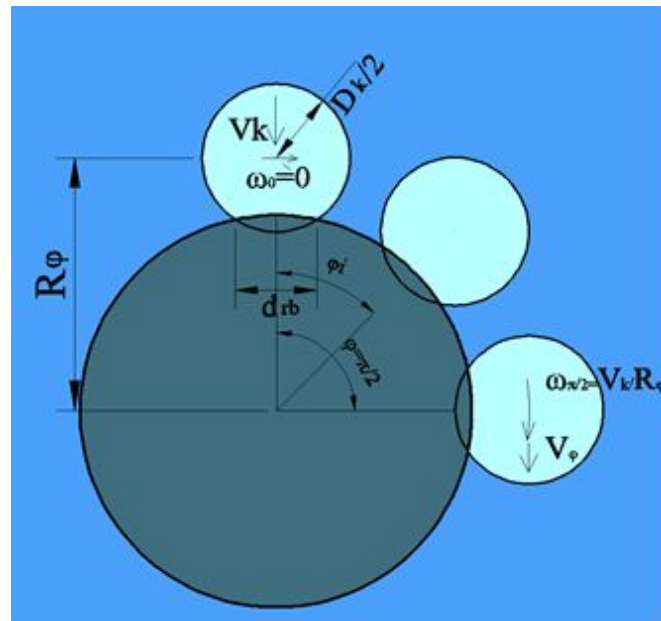
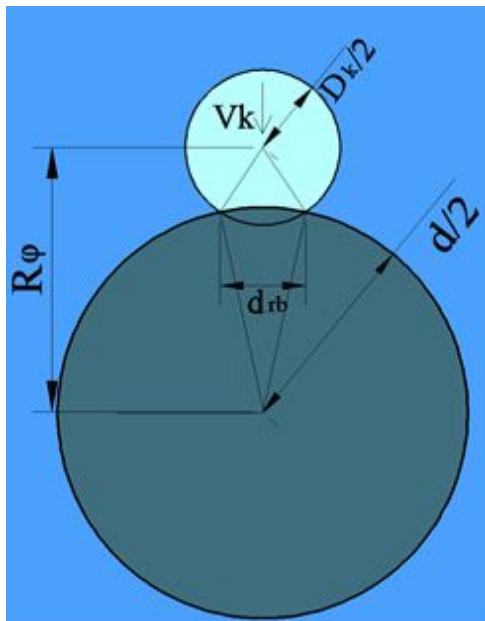

A possible scenario of interaction

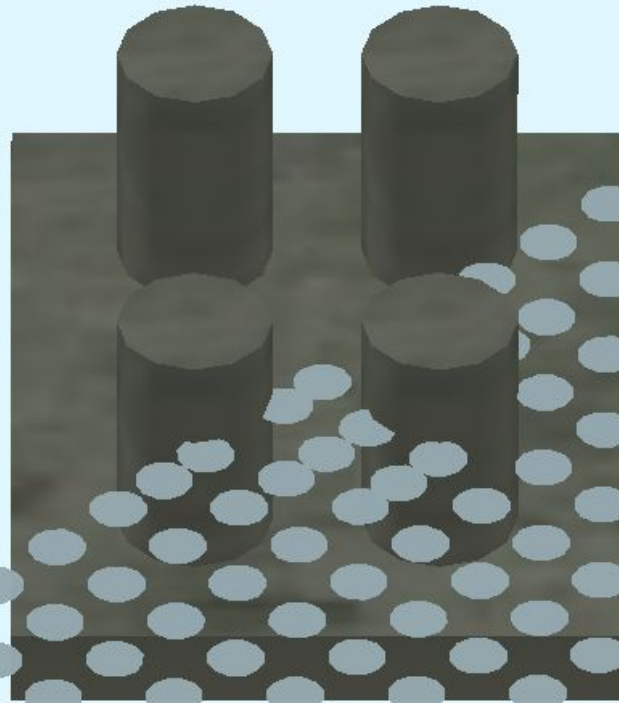

Scheme to determine the strength of ice depending on temperature

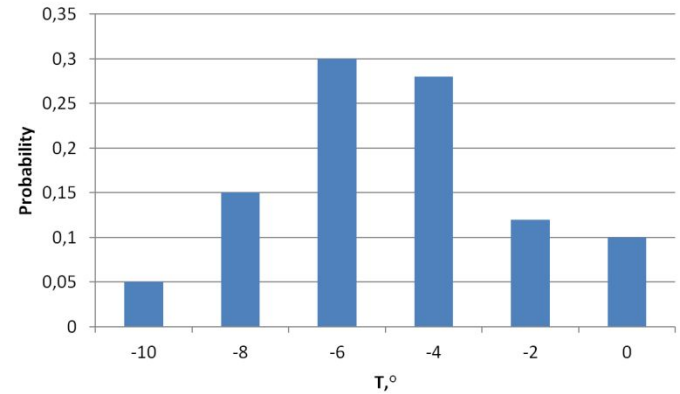
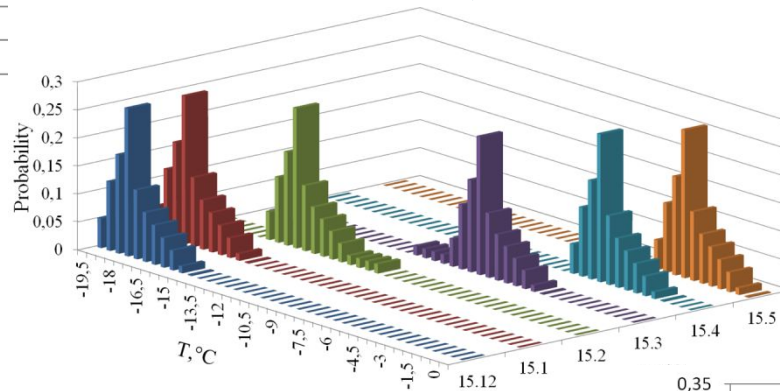
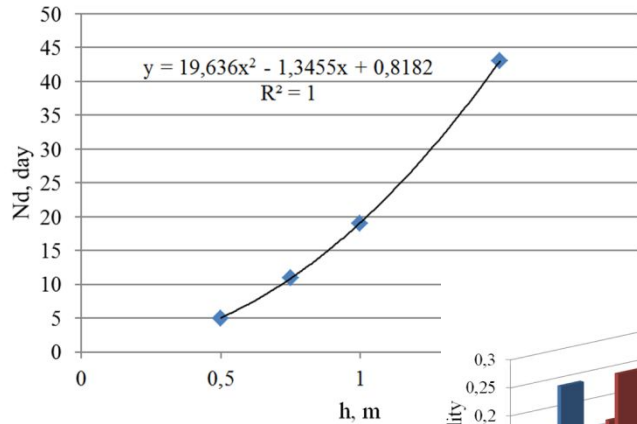

Scheme to determine the strength of ice depending on temperature

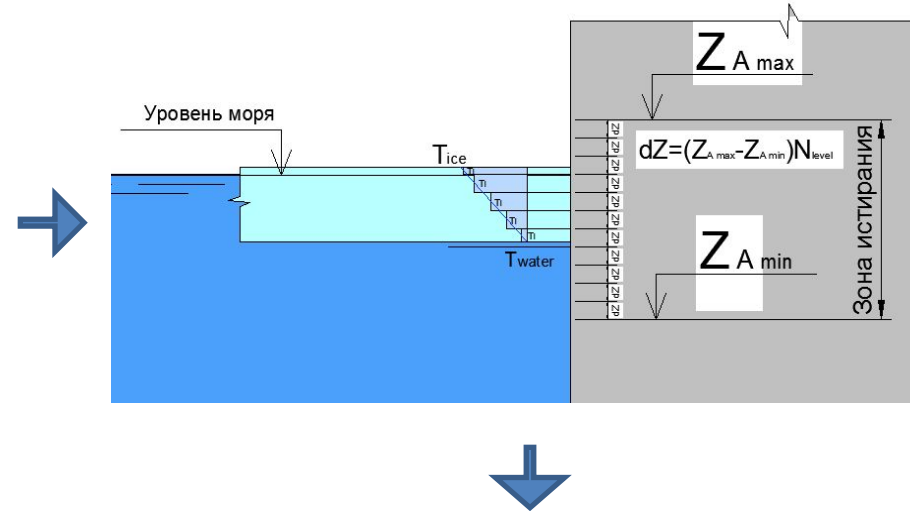
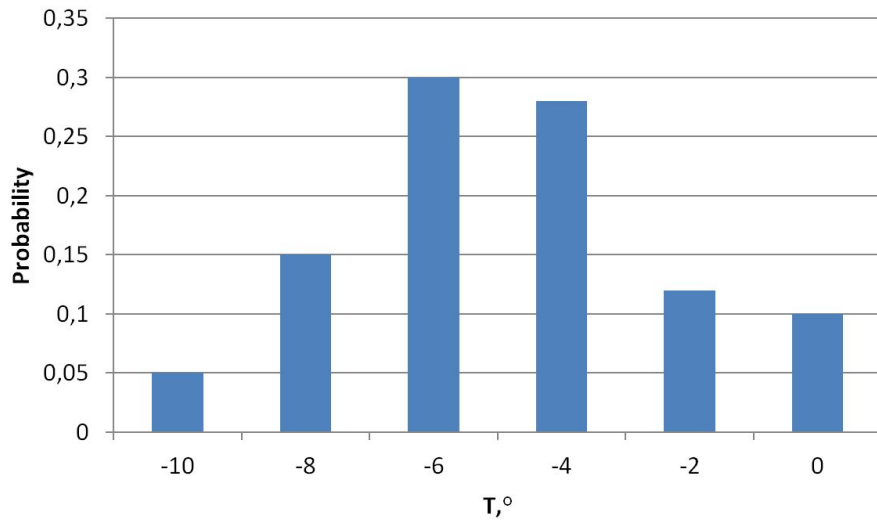

$$R_c = \sqrt{\frac{1}{N} \cdot \sum_{i=1}^N C_i^2}$$

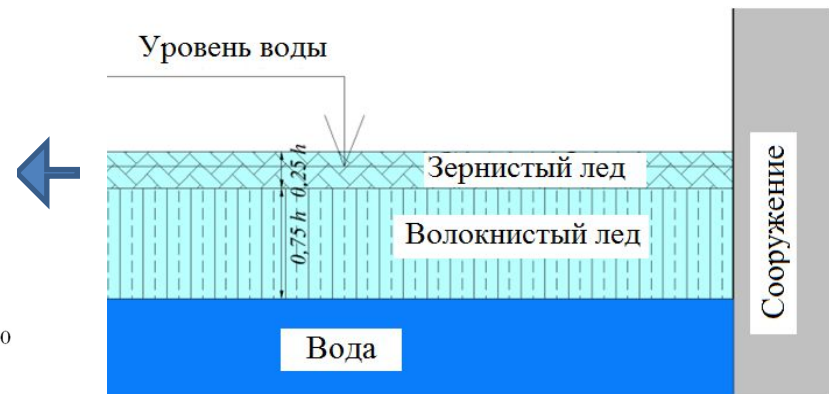
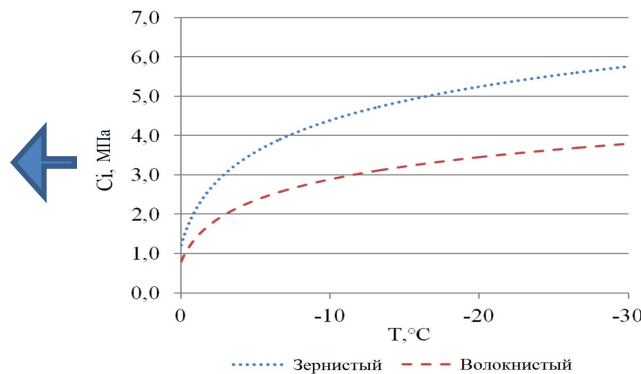

Mathematical model of variability in plane-altitude and in high-altitude variability of ice impacts

Система отсчета

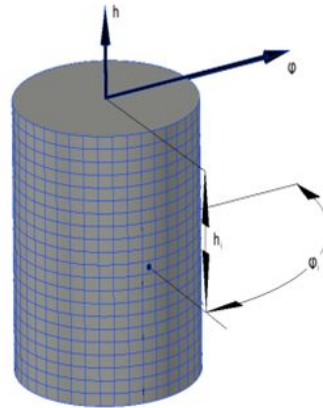
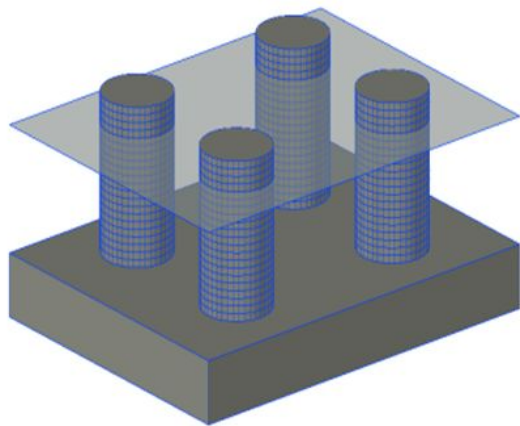

Привязка системы отсчета

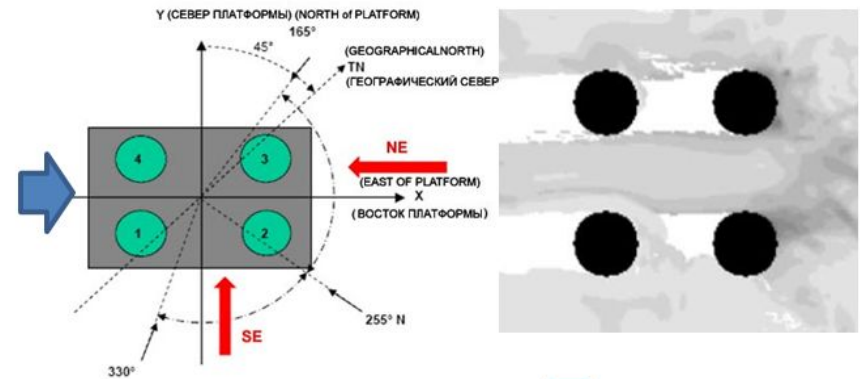

Результаты расчета

Накопление результатов в расчетной ячейке (кластере) сооружения:

$$\sigma_{cl} \quad l_{cl}(\varphi) \quad T_{cl}(z) \quad V_{cl}(\varphi)$$

Расчет, накопление и хранение данных

Результаты численного моделирования ледового воздействия на сооружение:

$$F_i \quad X_i \quad T_i \quad d_{cl}$$

Границы зоны контакта

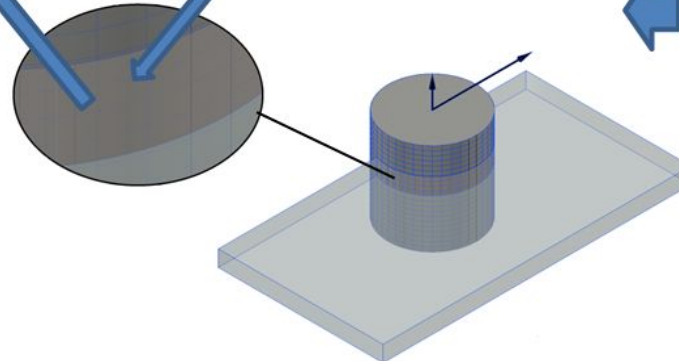
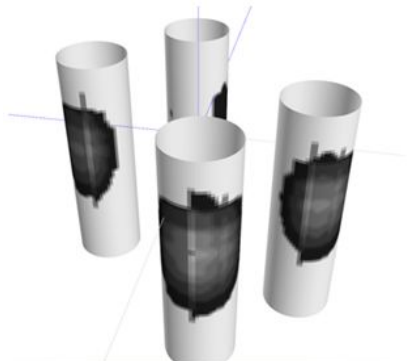
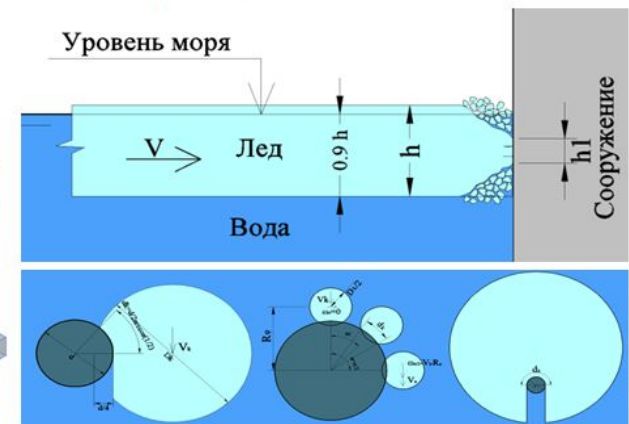

Resistance of building materials against ice abrasion

Abrasion Rig

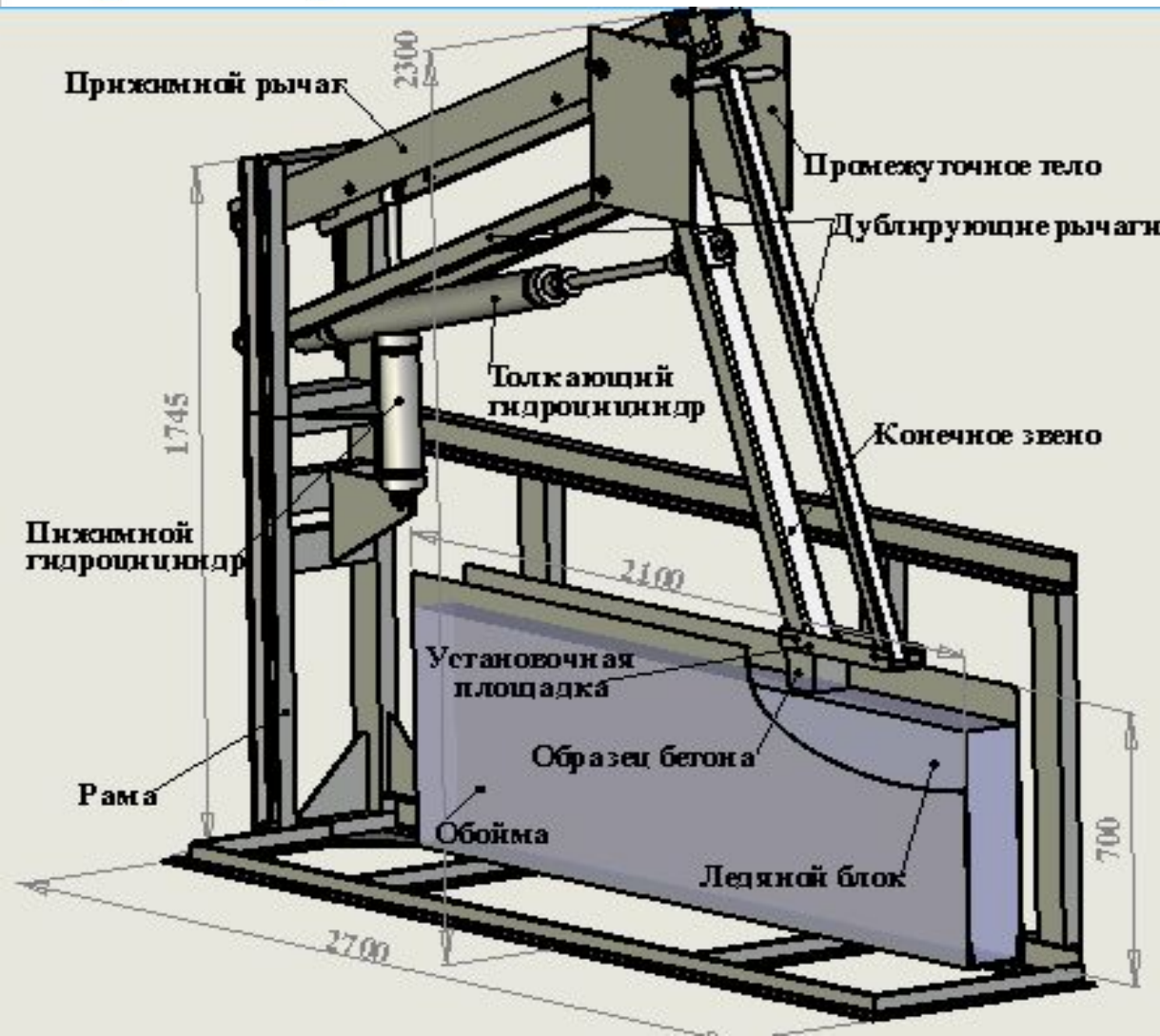

Experimental studies of ice abrasion

Abrasion Rig

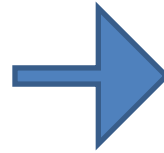
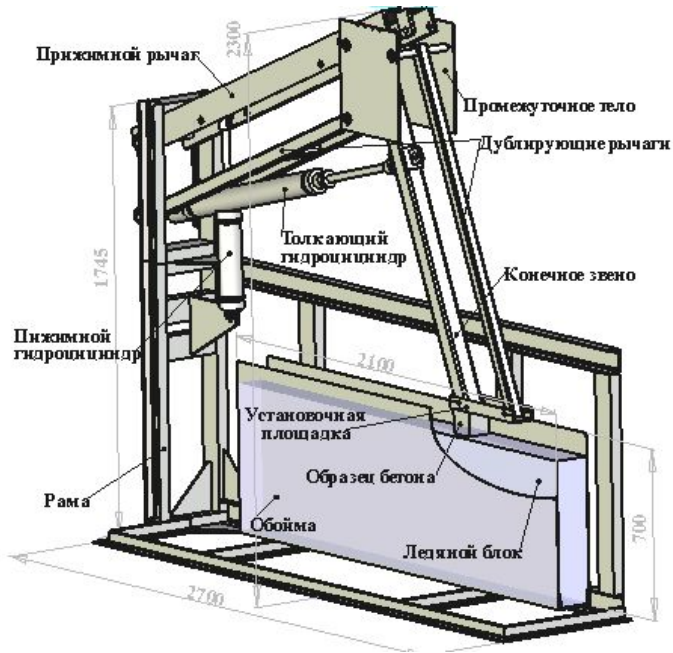

Concrete sample



Concrete sample after test

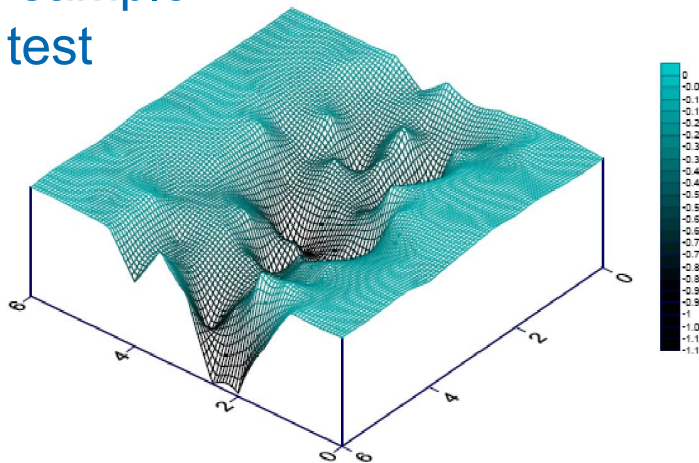

Depth dependence of abrasion from pressure and temperature

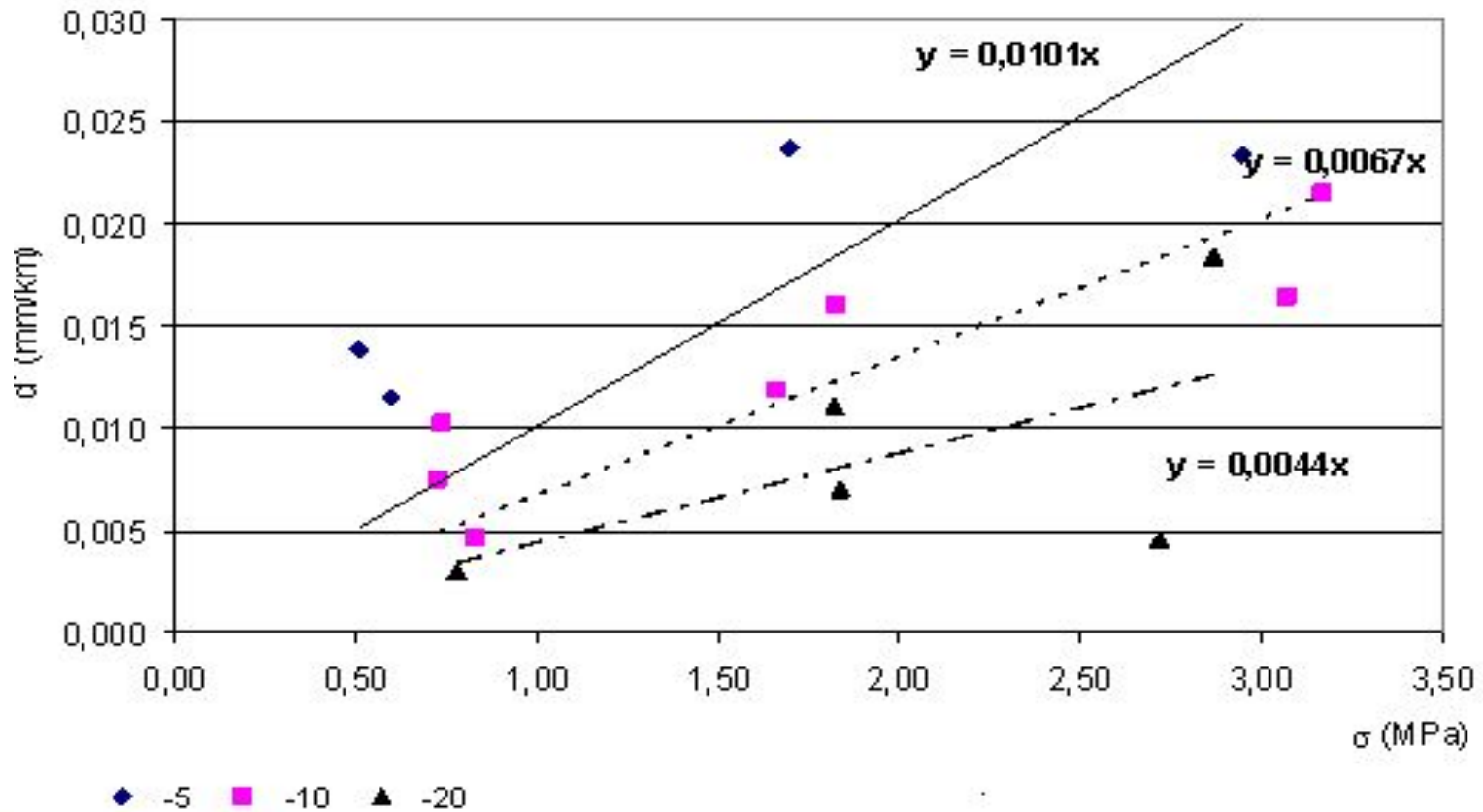

An empirical model of concrete resistance against ice abrasion

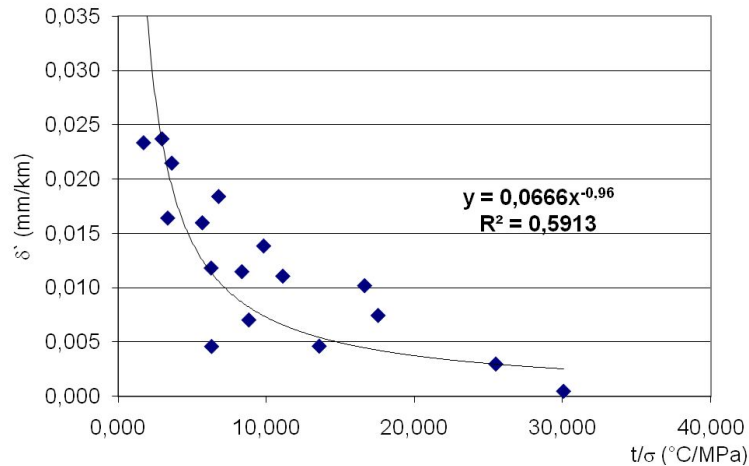

$$\delta'_{aver} = 0,0666 \left(\frac{T}{\sigma} \right)^{-0,96}$$

Concrete sample after ice abrasion tests and computer visualization of the sample surface after tests



General scheme of calculation of depth of ice abrasion

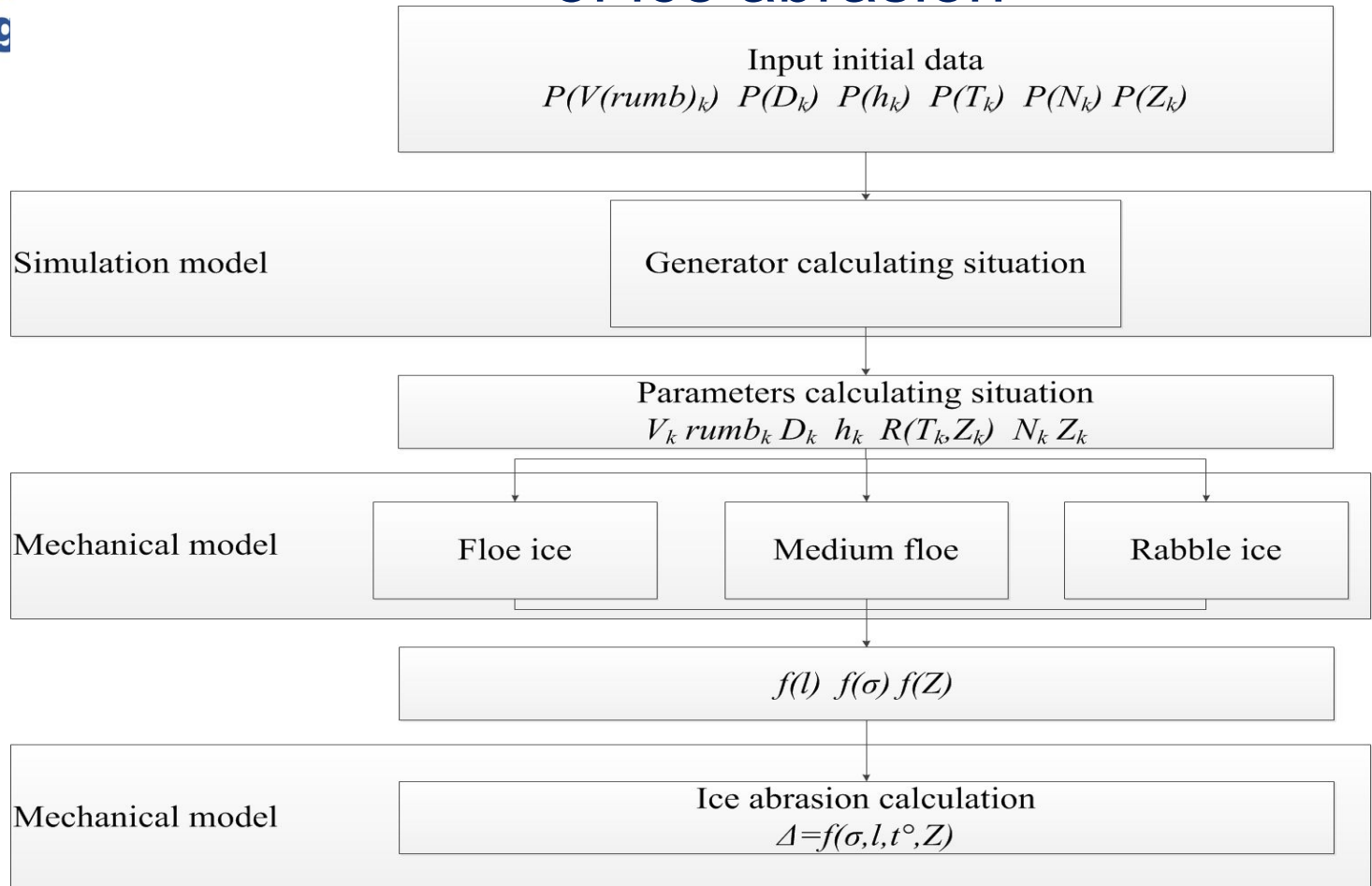

The procedure for calculating the factors affecting abrasion and the depth of abrasion of the material design

The initial data are:

- the parameters of structures (size \mathbf{d} , form supports \mathbf{m});
- the parameters of the ice cover (the speed of ice drift, \mathbf{V} , the thickness of the ice fields, \mathbf{h} , the ice concentration, \mathbf{N} , the strength of ice, \mathbf{R} , the diameter of the floe, \mathbf{D});
- sea level fluctuation distribution function ($\mathbf{Z}(t)$).

1. The simulation of the ice regime is carried out by iterating through the input parameters h , D , N , R , V , Z in such a way as to cover all the calculated situations, i.e. all possible combinations of parameters. As a result of the k -th time step (k -th decade) and the I -th combination of parameters, we simulate the specific situation of the ice regime with the following parameters: h_{ki} , D_{ki} , N_{ki} , R_{ki} , V_{ki} , Z_{ki} .

In addition, the probability of their occurrence is determined:

$$p_{ki}^h, p_{ki}^D, p_{ki}^N, p_{ki}^R, p_{ki}^V, p_{ki}^Z$$

The procedure for calculating the factors affecting abrasion and the depth of abrasion of the material design

2. The time of existence of the i -th combination of parameters of the ice regime t_k is determined taking into account the probabilistic combination of parameters.

3. At each i -th step of the simulation calculation, we model the process of mechanical interaction of ice formations with the support of engineering structures with a thickness of h_{ki} , the size of ice fields D_{ki} , concentration N_{ki} , strength R_{ki} and speed V_{ki} , and also takes into account the process of sea level fluctuations Z_{ki} . Consider the process has a duration of t_{ki} .

4. On the basis of the data obtained, the process of the construction material abrasion is simulated. As a result, the abrasion depth of the structure material S is calculated taking into account the sea level fluctuations.

Computer programs for calculation of ice abrasion

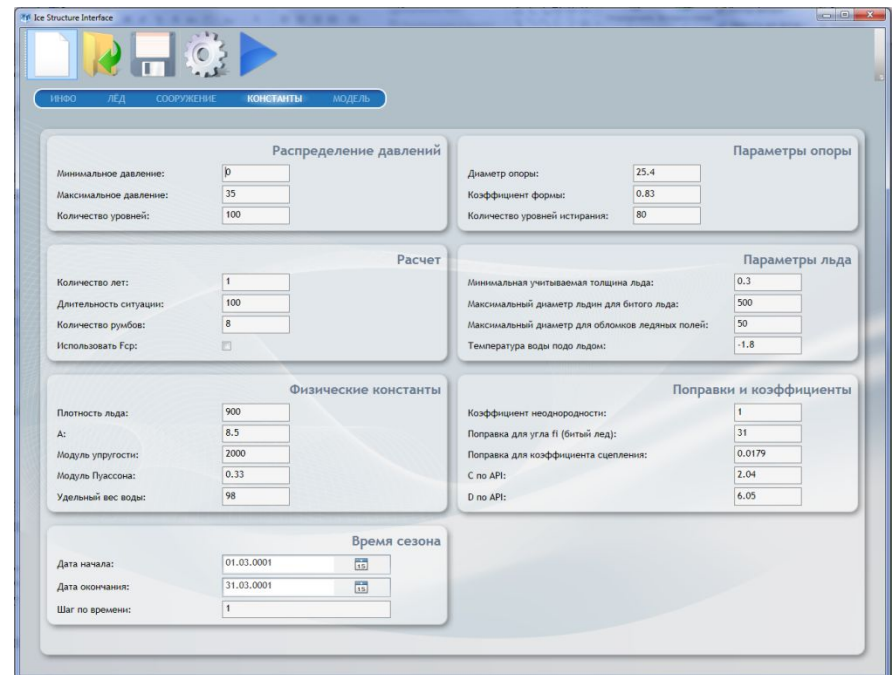
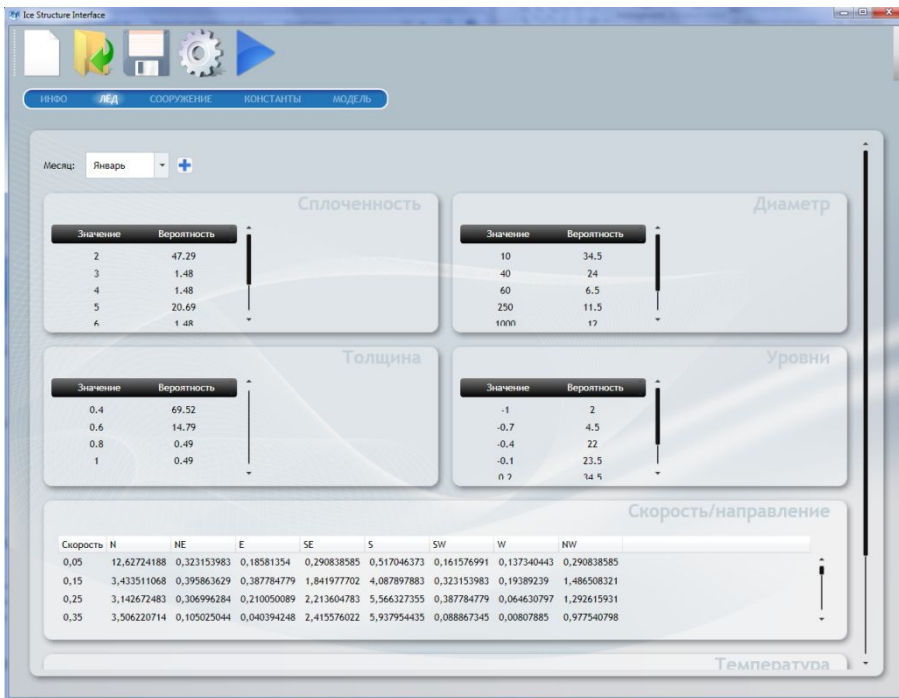
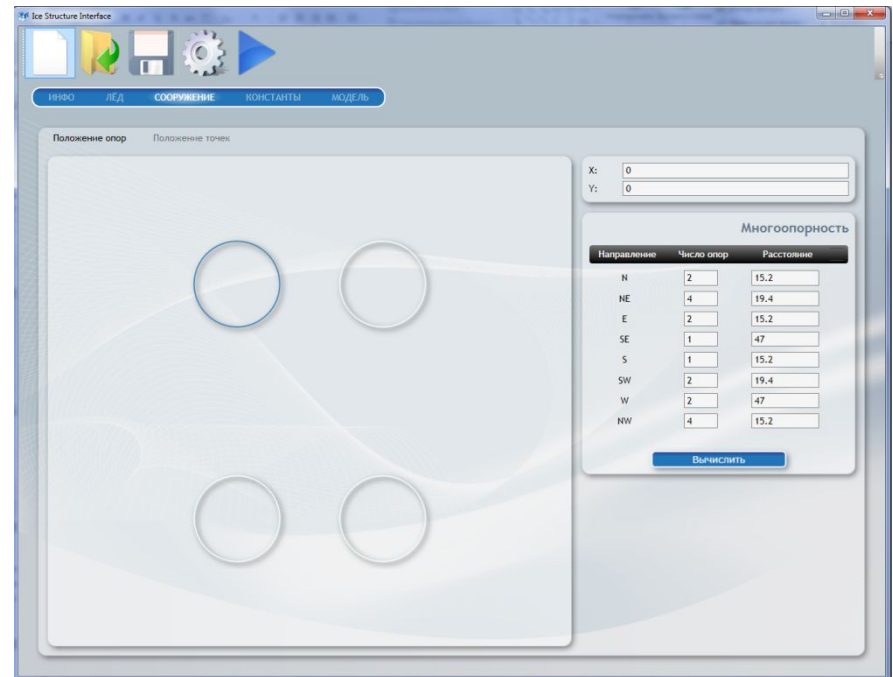

Calculation example

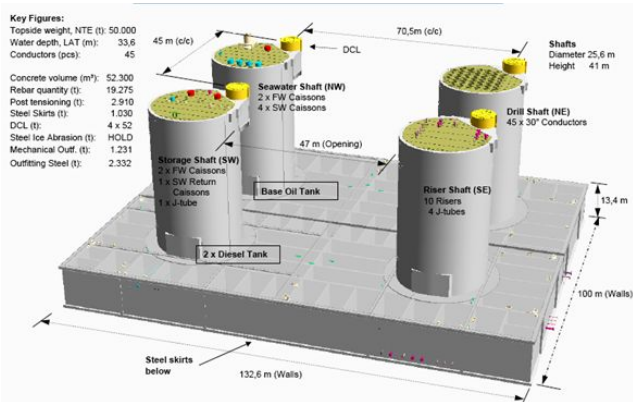

Design GBS for Arkutun-Dagi Field

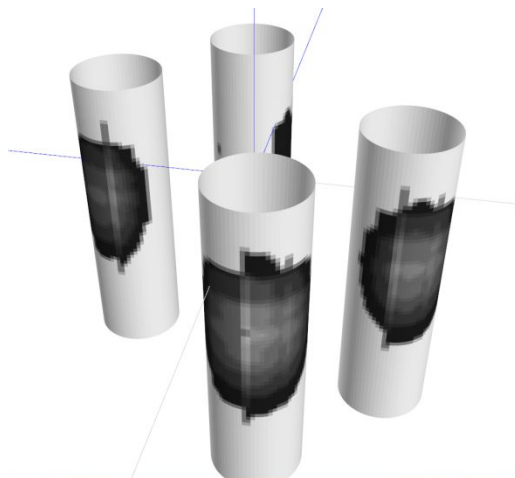

Result of calculation

Result of calculation

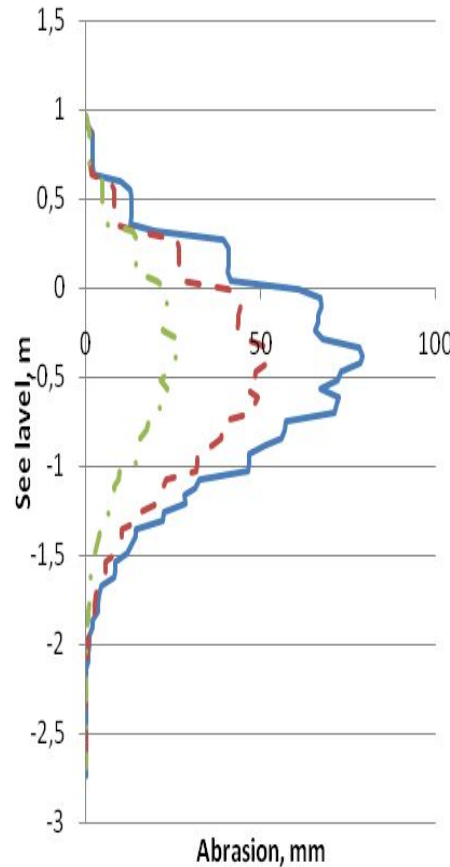

- complete abrasion
- - - broken ice abrasion
- · · Ice fields abrasion

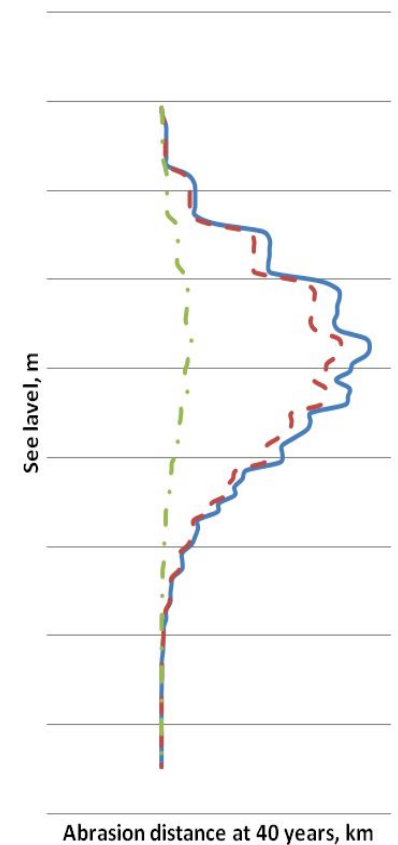

- Abrasion complete distance
- - - Broken ice
- · · Ice fields

Verification of Mathematical Models and of Ice Abrasion Calculation Methodology

Verification Scheme

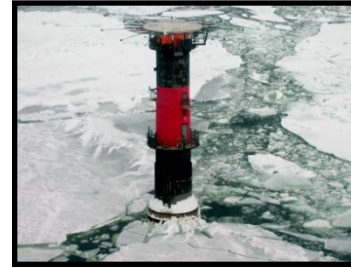
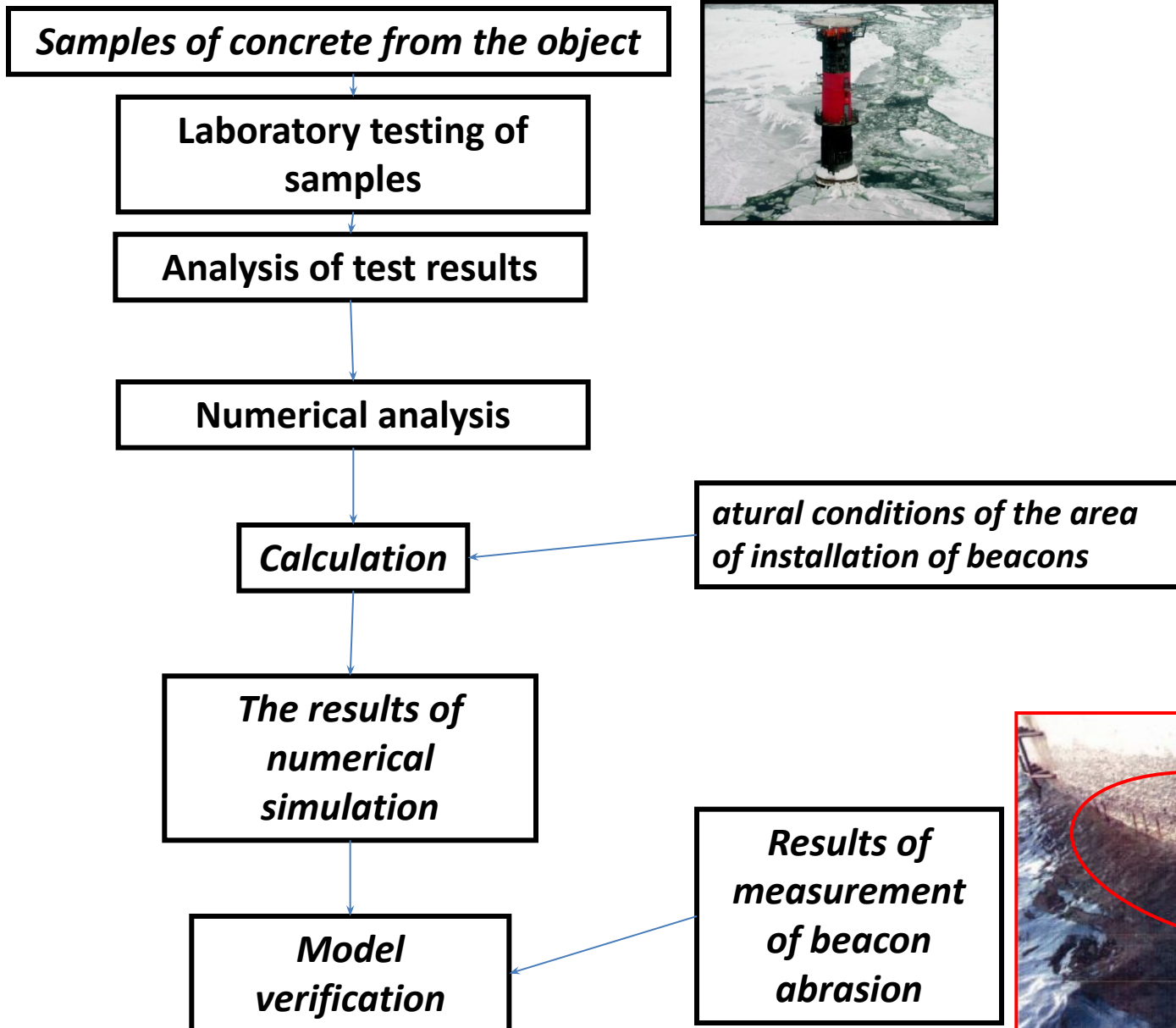

Finish Lighthouses



RAAHE
64 39,1 N 24 13,6 E



OULU 2
65 10,5 N 24 35,5



OULU 3
65 08,8 N 24 39,7 E

The location of the lighthouses in the Gulf of Bothnia



Nature Conditions of Baltic Sea

РААНЕ Lighthouse

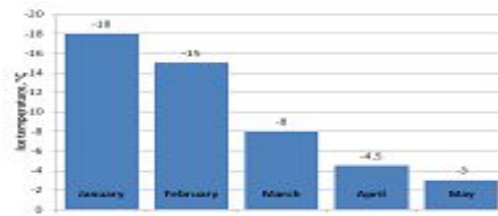

Гистограмма температуры льда
 T_i , °C

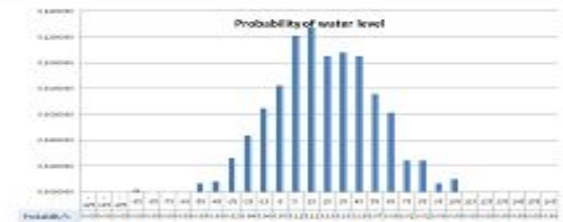

Гистограмма колебания уровня моря
 Z , м

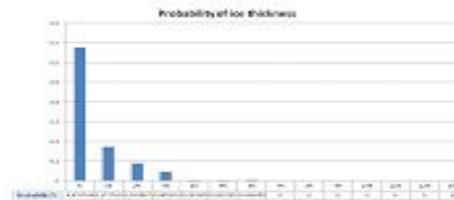

Гистограмма толщины льда
 l_2 , м (январь)

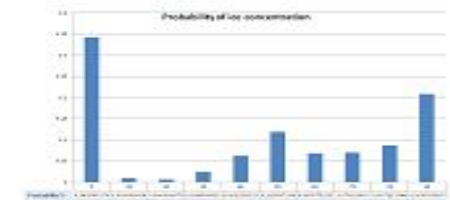

Гистограмма сплоченности льда
 N (январь)

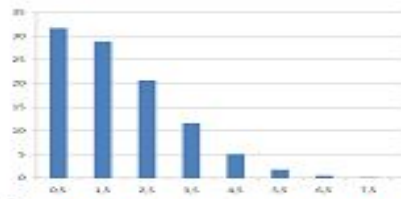

Гистограмма прочности льда
 R , МПа (январь)

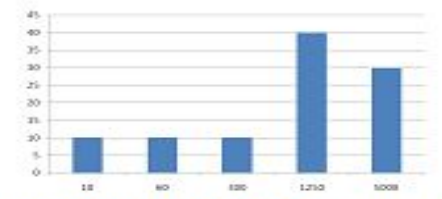

Гистограмма размеров ледяных полей
 D , м (январь)

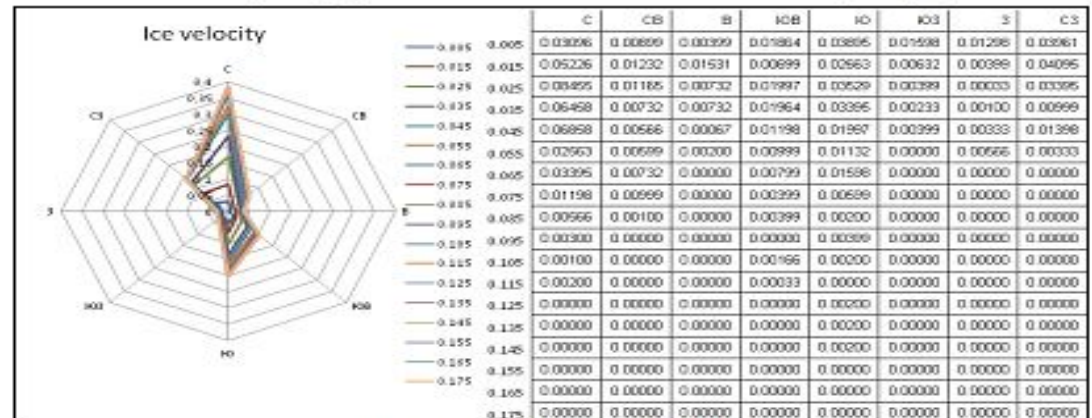

Роза скорости дрейфа льда
 V , м/с (январь)

Experimental studies of the resistance of concrete samples taken from the foundations of beacons of ice abrasion

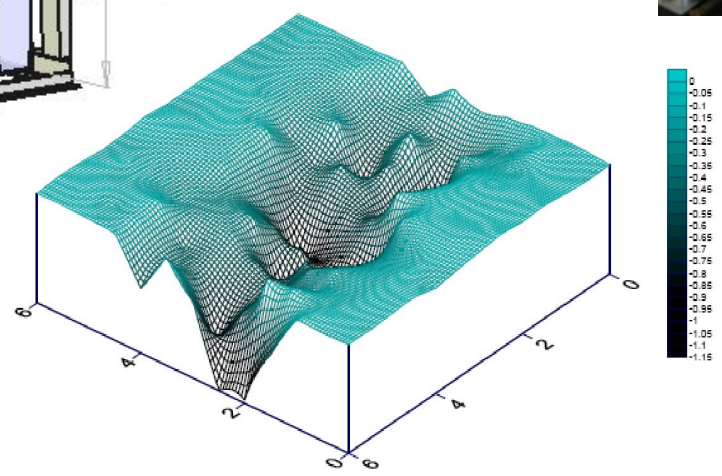
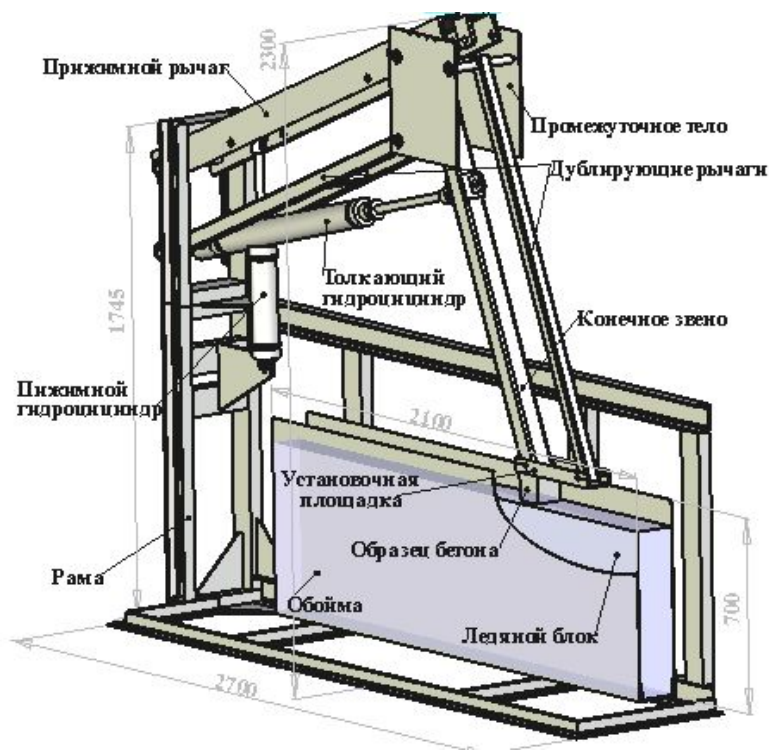

The empirical model of the intensity of ice abrasion

RAAHE

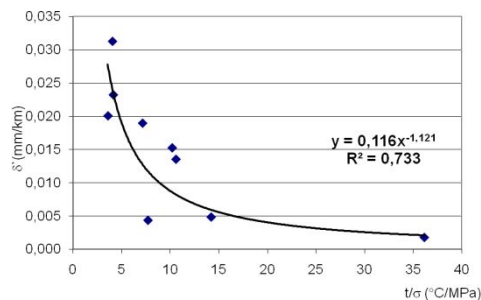

$$\delta'_{aver} = 0,116 \left(\frac{T}{\sigma} \right)^{-1,121}$$

OULU 2

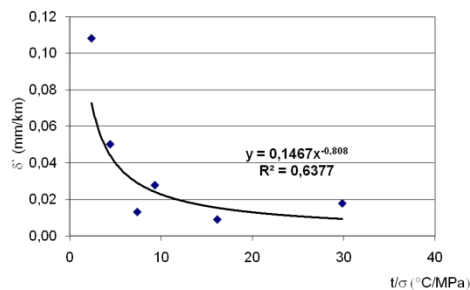

$$\delta'_{aver} = 0,1467 \left(\frac{T}{\sigma} \right)^{-0,808}$$

OULU 3

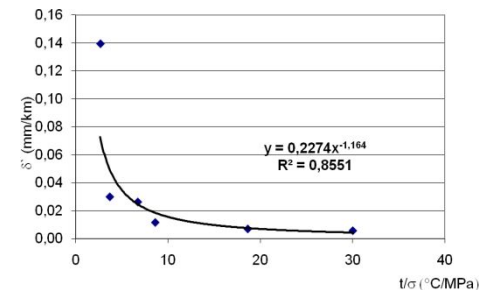

$$\delta'_{aver} = 0,2274 \left(\frac{T}{\sigma} \right)^{-1,164}$$

Results of Calculations (RAAHE)

Raahe North

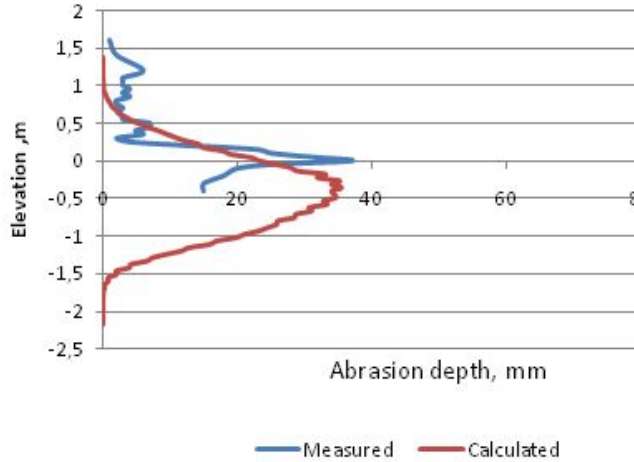

Raahe East

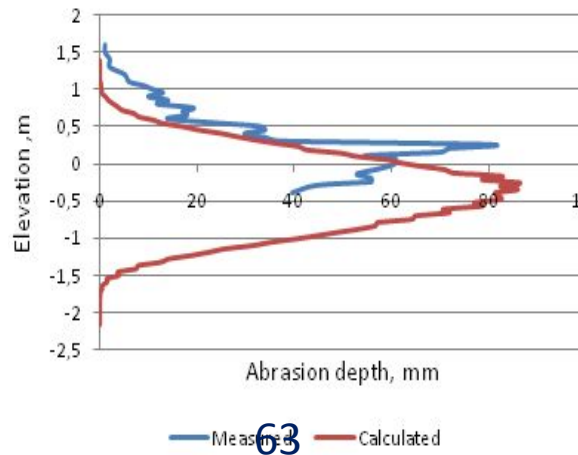

Raahe South

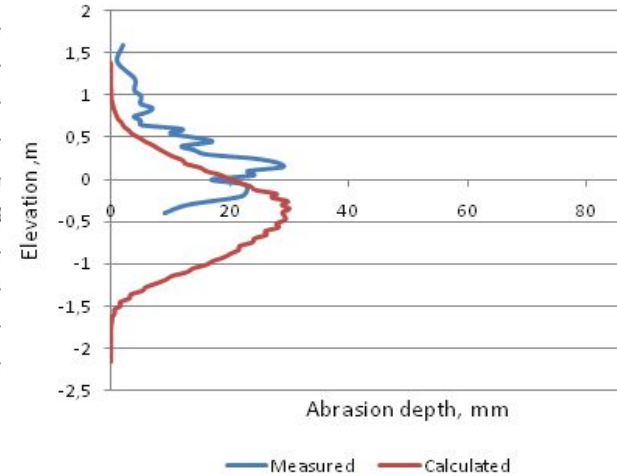

Raahe West

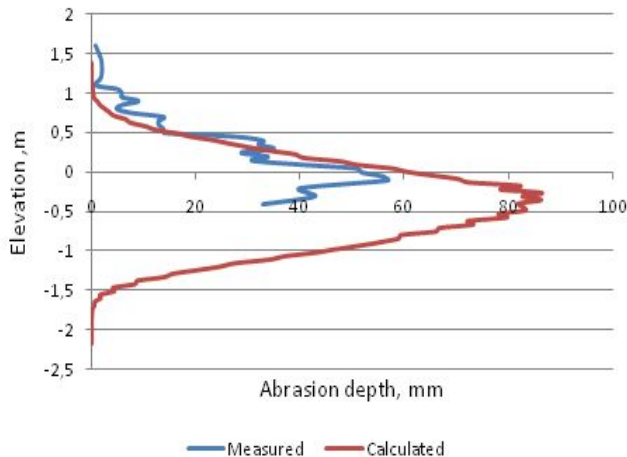

63
Calculation results and observed depth of ice abrasion

No	Parameter	Raahe
1	The estimated level, m	- 0,168
2	The estimated attrition over the 44 years of operation, mm	83
3	Full-scale measurements of abrasion for 44 years, mm	80

Results of Calculations (RAAHE)

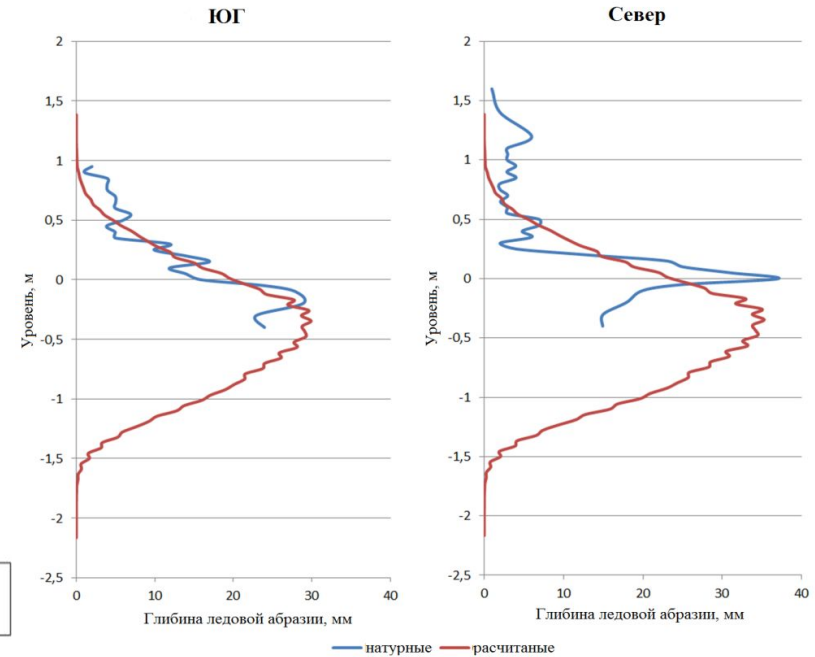
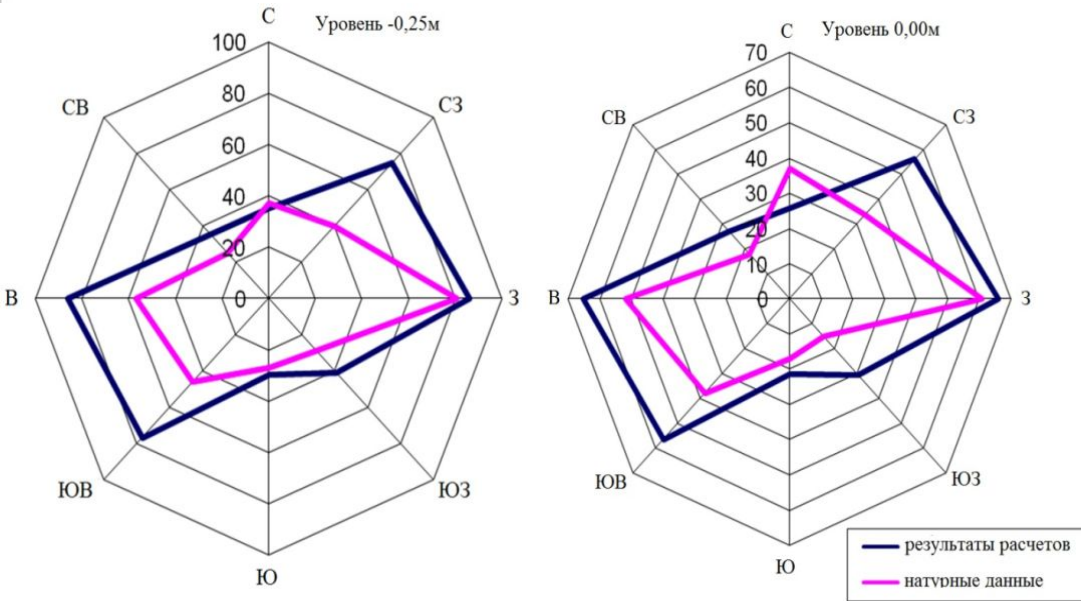

Realization of Ice Abrasion Calculation Methodology (Sakhalin 1 project)

Ice protection devices

Concrete Gravity Base
Structure PA-B

Concrete Gravity Base
Structure Lun-A



The cutting process of ice cover by GBS Lun A



Destruction of steel protection belt on Lun-A from ice abrasion



Destruction of metal protection devices from ice abrasion

Platform PA-A



Platform PA-B



Possible options for protection of ice abrasion Decision

STEEL ICE RESISTANT BELTS



CONCRETE ICE RESISTANT BELTS



HOW TO CALCULATE?

The results of calculation of the abrasion depth of concrete by ice for Arkutun-Dagi GBS (Sakhalin 1)

Design GBS Arkutun-Dagi

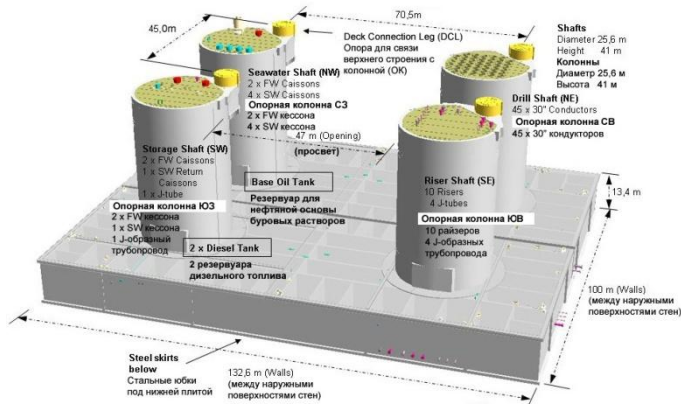

Computer 3d visualization of calculation results

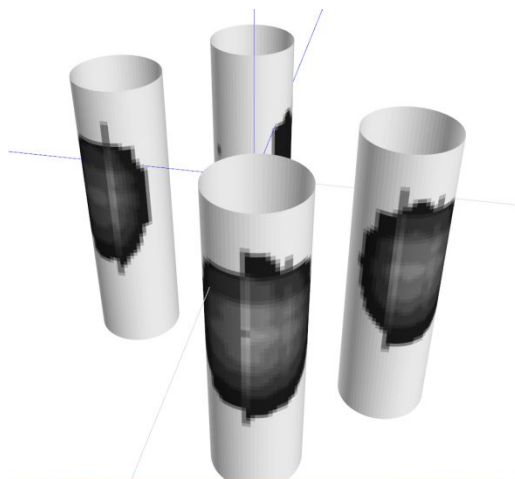

Depth of ice abrasion in 40 years (mm)

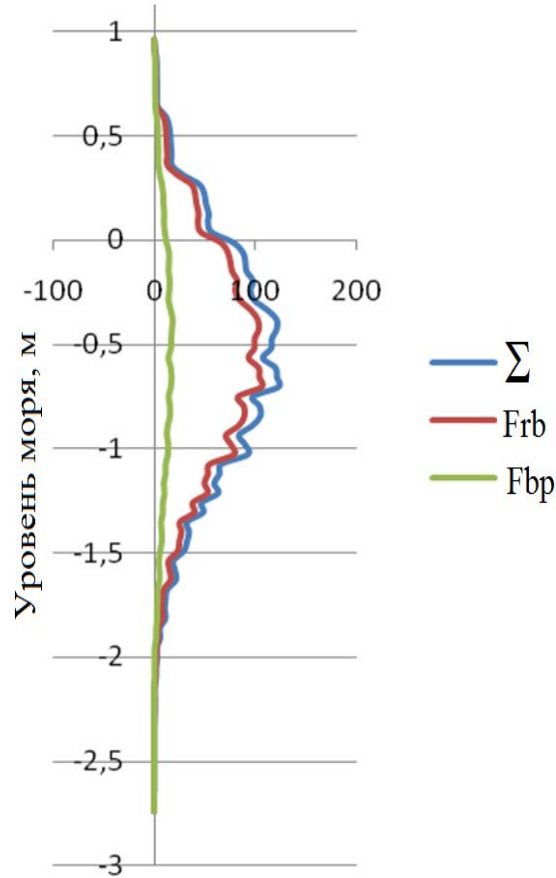

The length of the abrasion path for 40 years (km)

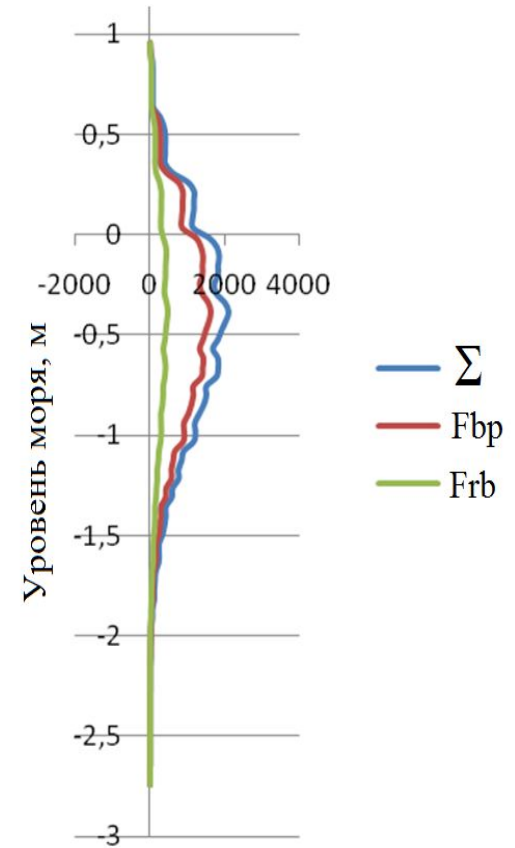

**Ice Resistance
Fragment of GBS Legs,
scale 1:1**



Assessment of the depth of ice abrasion on the example of concrete base Arkutun-Dagi (Sakhalin 1)



Arkutun-Dagi GBS in floating position

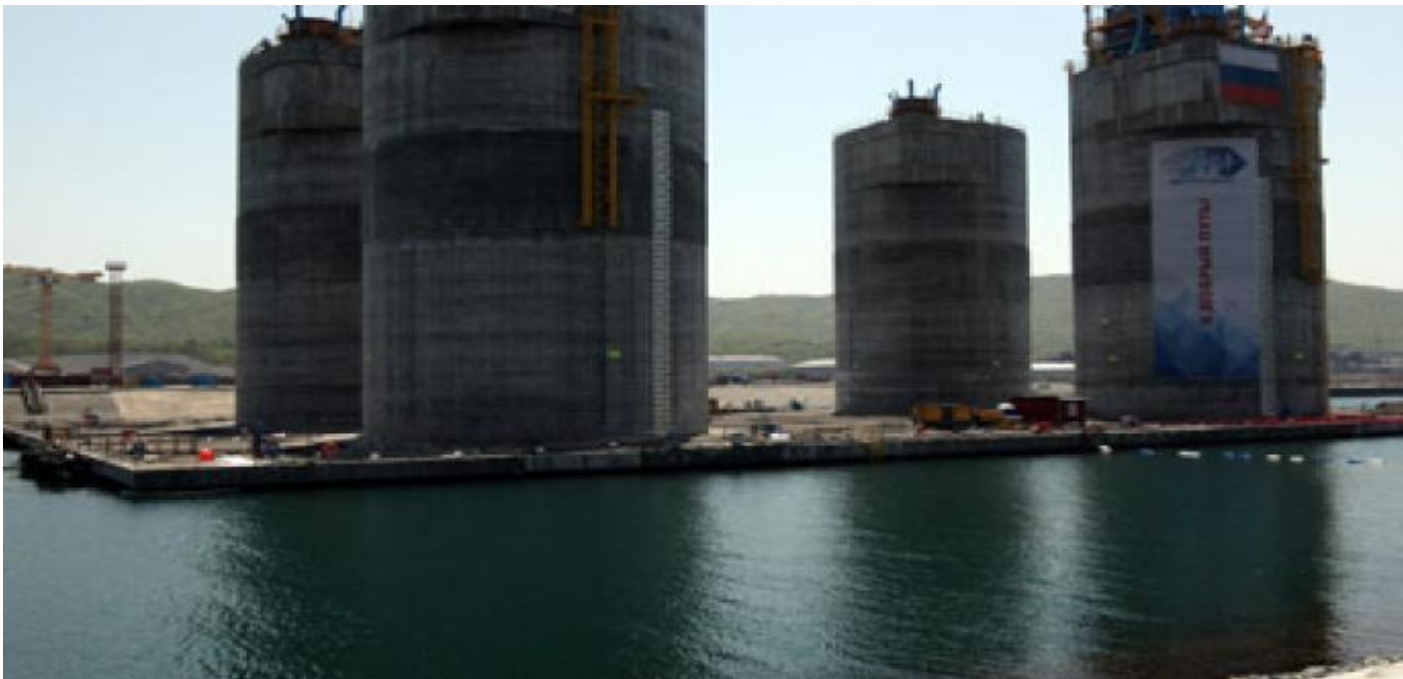





Platform “Berkut”



Results

ON THE BASIS OF THE ADOPTED CONCEPT AND PROBABILISTIC APPROACH IS DEVELOPED

- General simulation probabilistic model of formation of ice loads from drifting ice cover on sea structures for the entire period of operation;
- A phenomenological model of destruction of the ice plate on contact with structure and the method of determining the rate of change of ice load;
- Mathematical model of mechanical interaction of drifting ice fields with the structure;
- The method of determining the number of cycles and loading conditions of structure and their elements is recommended for practical application;
- Mathematical model for determining the distribution of ice loads from ice fields for the calculation of structures for the gradual failure;
- Mathematical model for determining the maximum values of ice loads from hummocks for calculations for sudden failure;
- Mathematical model for calculating the abrasion depth of the structure material for the entire period of operation;
- Verification of methodology and mathematical models on full scale data base.

Thank you for Attention

