

Zelio Logic - Communication Extension

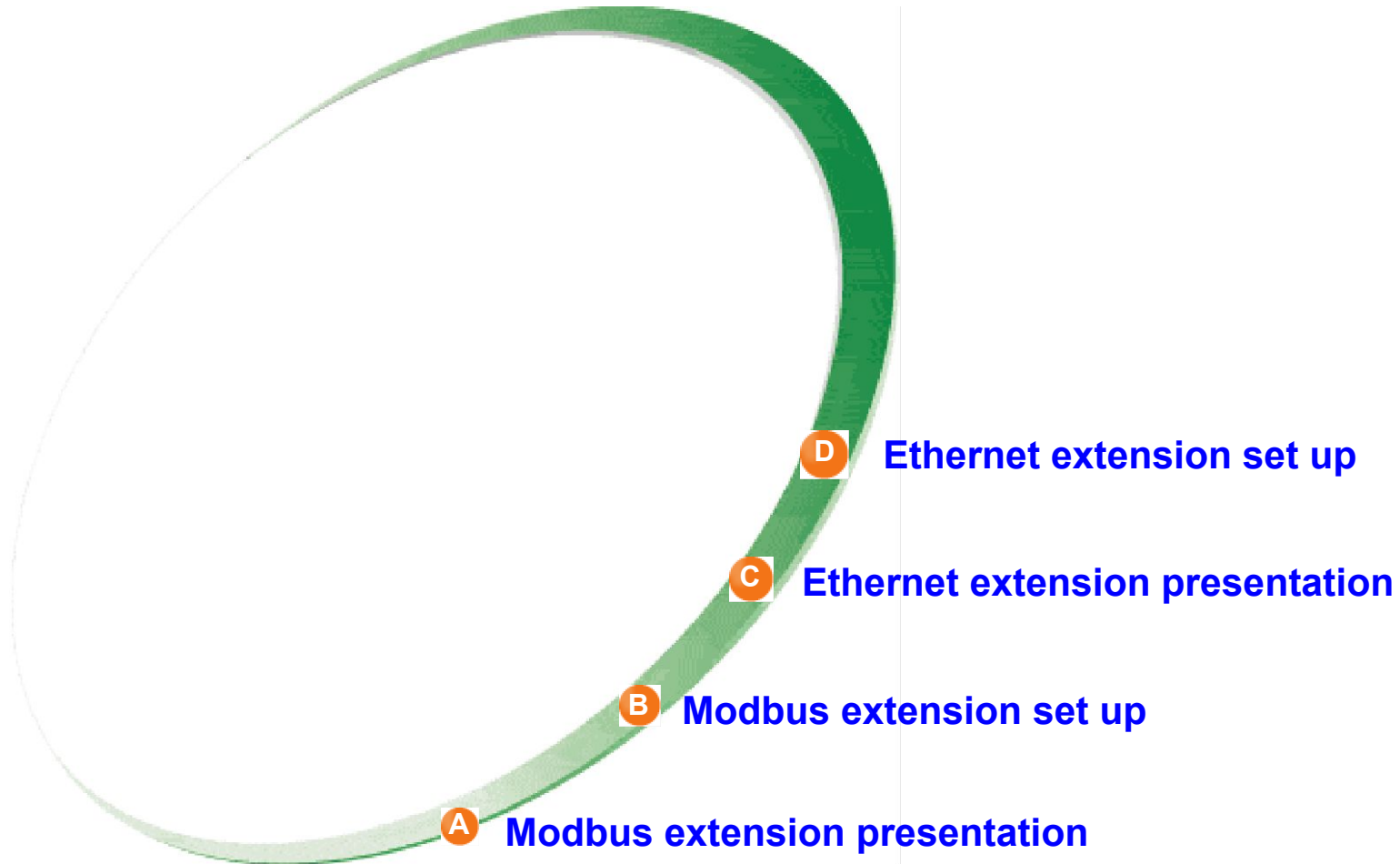

Modbus extension Presentation

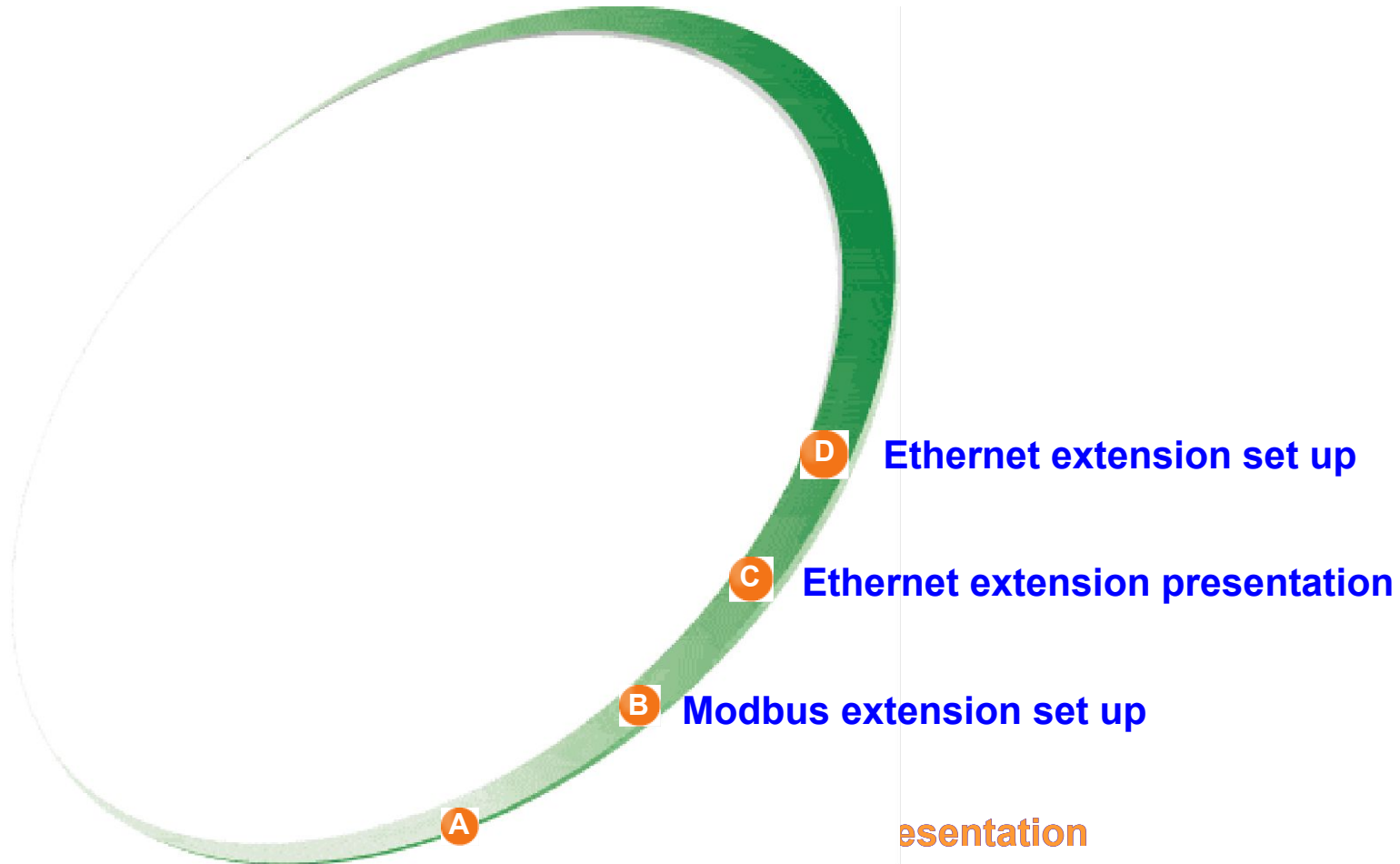

Characteristics

- Zelio logic connected on modbus via the Modbus extension module

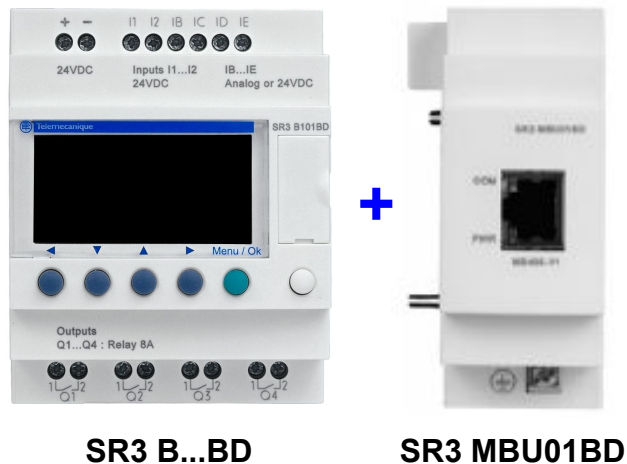

SR3 B...BD

SR3 MBU01BD

- With modular Zelio Logic power supply 24 VDC
- Modbus slave not electrically isolated, RTU/ASCII protocol
- Configuration : Zelio HMI or Zelio- Soft
 - Number of wires = **2**, 4
 - Frames format = **RTU** or ASCII
 - Speed = 1200, 2400, ..., **19200**, ..., 57600
 - Parity = **none**, even, odd
 - Address = **1** to 247

In bold =>
factory setting

Characteristics

■ Modbus requests supported

- Read multiple registers : Modbus function code = 03 (0x03)
 - Write simple register Modbus function code = 06 (0x06)
 - Write multiple registers Modbus function code = 16 (0x10)
 - Read device identification Modbus function code = 43 (0x2B)
- ✓ The broadcast mode is supported (writing to address 0).

To get more information concerning the Modbus protocol, see the Web site **Modbus.org**
<http://modbus.org>

Description

■ Front panel

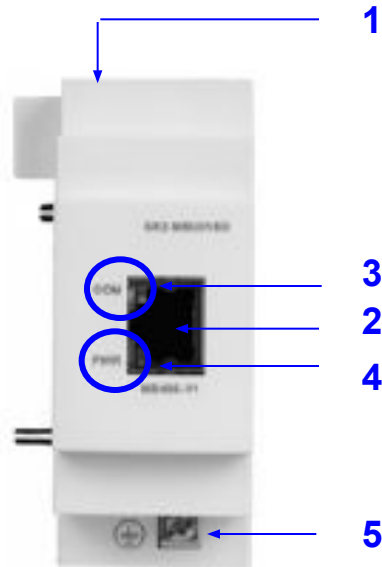

SR3 MBU01BD

- 1 Mounting : on rail 35mm, retractable mounting feet,
- 2 Connector RJ45 : Modbus fieldbus connection
- 3 DEL « COM » : communication status
- 4 DEL « PWR » : Product powered or in fault
- 5 Screw for connection to the protection ground

Pin number of connector RJ45	2 wires Modbus	4 wires Modbus
1	NC	RXD0
2	NC	RXD1
3	NC	NC
4	D1	TXD1
5	D0	TXD0
6	NC	NC
7	NC	NC
8	Common	Common

Modbus extension set up

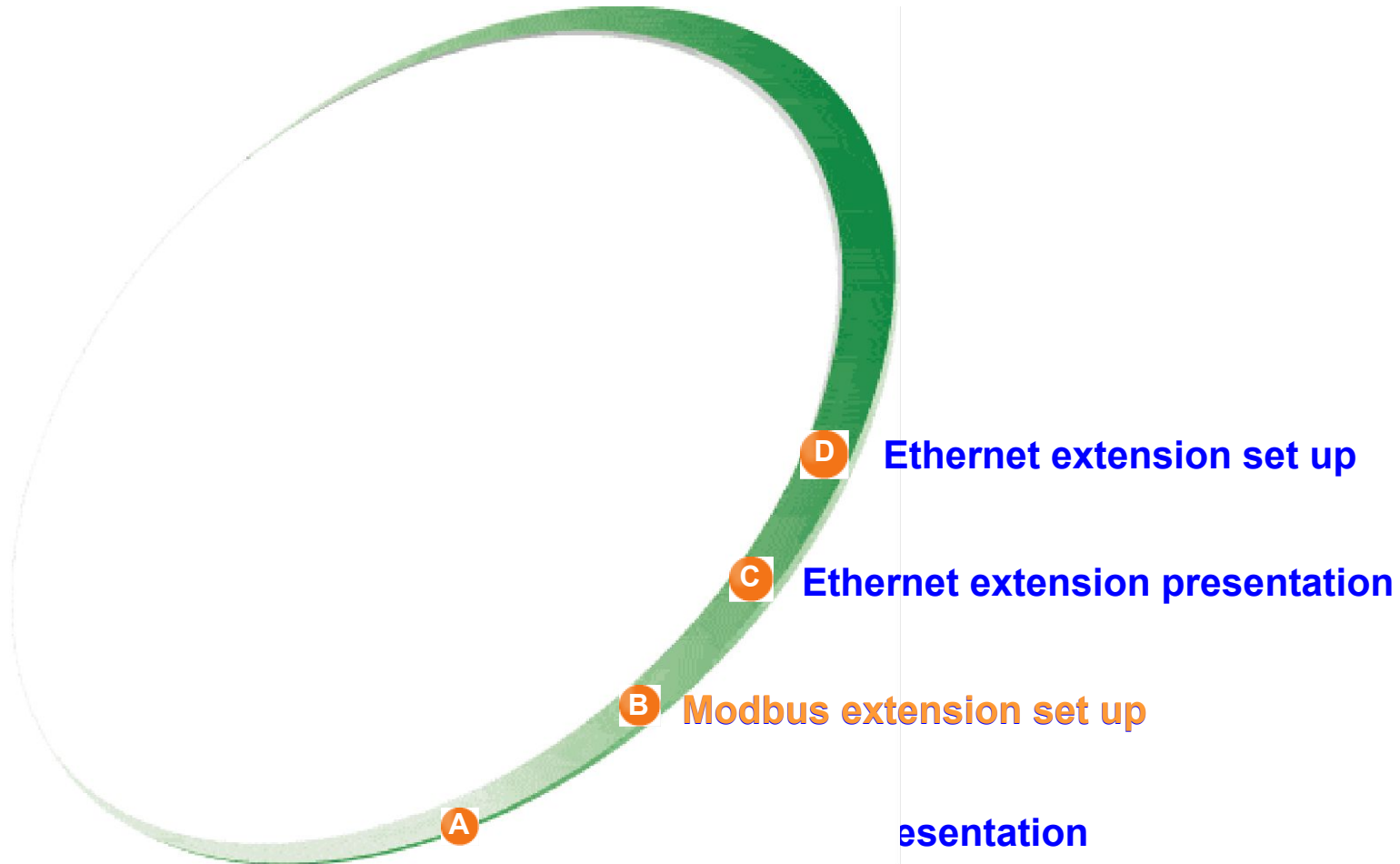

Configuration

Using of Zelio HMI

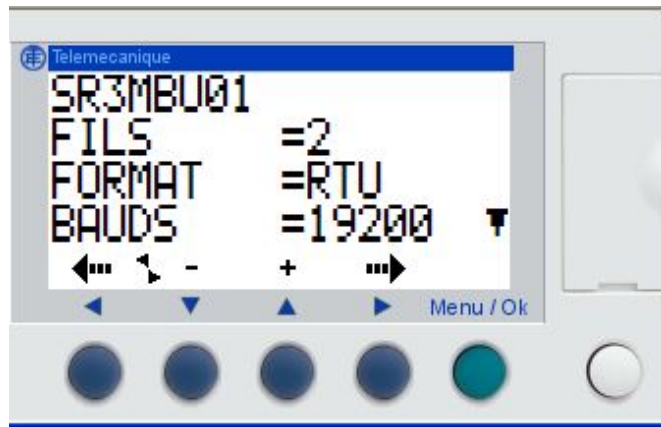

From the main menu : Select the “ CONFIGURATION ” and select “ INIT.MODBUS ” to access to modbus parameters.

Using of Zelio-Soft

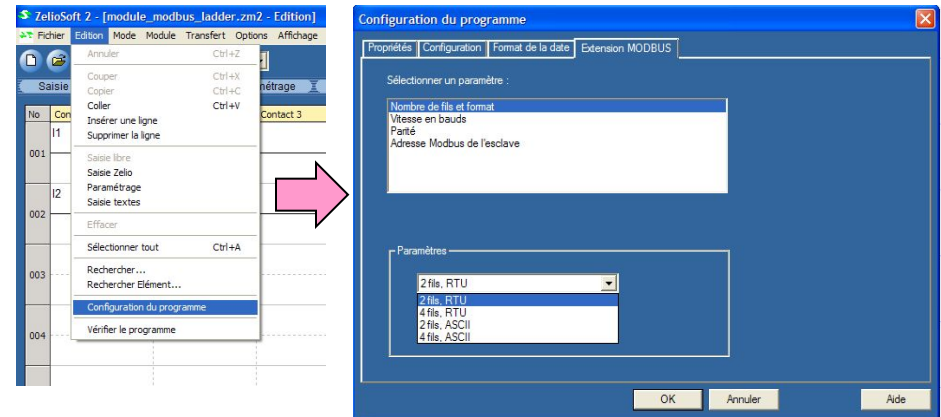

From the edition menu : Click on program configuration and click on tab “ MODBUS extension ” to access to modbus parameters.

Ladder language - LADDER

■ Modbus exchanges

Modbus exchanges are implicit and transparent for Zelio.

The Zelio application data are not accessible by the master.

Modbus exchanges	Modbus function code	Modbus registers
Read of Zelio Inputs/Outputs	03 (read multiple words)	Word 20 : base inputs I1 to IG Word 21 : extension inputs IH to IR Word 22 : base outputs Q1 to QA Word 23 : extension output QB to QG
Read/Write of Zelio clock	03 (read multiple words) 06 (write single word) 16 (write multiple word)	Word 32 : Day of the week, Seconde Word 33 : Minutes, Hours Word 34 : Day of the month, Month Word 35 : Year, century
Read Status of Zelio module	03 (read multiple words)	Word 48 : bit 0 = Run/Stop, bit 1 = Monitoring, bit 2 = Alarm, bit 3 = Error, bit 7 = Time out bit 8 à F = Alarm code

Function Block Diagram - FBD

■ 2 exchanges types

Implicit exchanges with the master Modbus.

Input/Output datas between the Zelio application and the master Modbus

□ Implicit exchanges with the master

Modbus exchanges	Modbus function code	Modbus registers
Read/Write of Zelio clock	03 (read multiple words) 06 (write single word) 16 (Write multiple word)	Word 32 : Day of the week, Seconde Word 33 : Minutes, Hours Word 34 : Day of th month, Month Word 35 : Year, Century
Read Status of Zelio module	03 (read multiple words)	Mot 48 : bit 0 = Run/Stop, bit 1 = Monitoring, bit 2 = Alarm, bit 3 = Error, bit 7 = Time out bit 8 à F = Alarm code

Remark : In FBD mode, the state of Zelio I/O are not accessible with implicit exchanges.

Function Block Diagram - FBD

- **Inputs/Outputs data words exchange between Application Zelio / Master**
 - 4 inputs words : **J1XT1 to J4XT1**
 - 4 outputs words : **O1XT1 to O4XT1**

Requests modbus	Modbus Function code	Modbus registers	Inputs/Outputs Zelio
Read/Write 4 words (16 bits) Zelio	03 (Read multiple words) 06 (Write single word) 16 (Write multiple word)	Word 16 Word 17 Word 18 Word 19	J1XT1 J2XT1 J3XT1 J4XT1
Read 4 words (16 bits) Zelio	03 (Read multiple words)	Word 20 Word 21 Word 22 Word 23	O1XT1 O2XT1 O3XT1 O4XT1

Function Block Diagram - FBD

- Inputs/Outputs data words exchange between Application Zelio / Master

Screen of FBD Editor

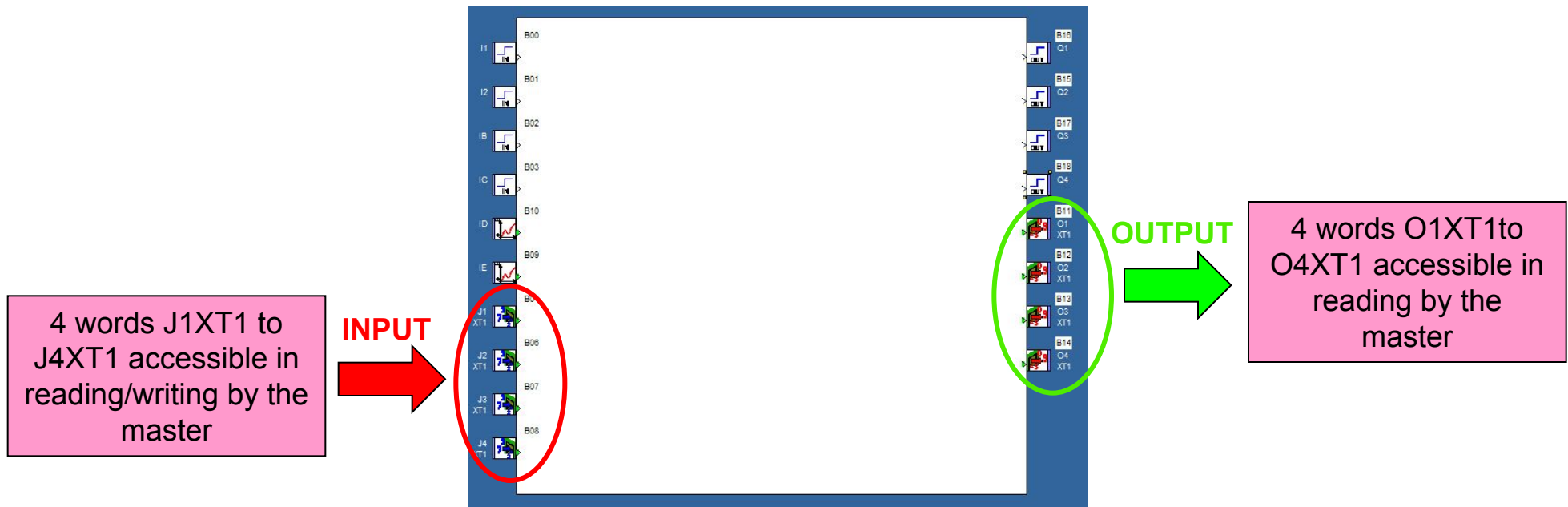

Application example

The application Zelio check the temperature. The controller Twido transmit the temperature set point (threshold) to Zelio via the fieldbus modbus. The measure of temperature is wiring on the Zelio analogue input. If the temperature is higher than the threshold, an alarm is activate (Klaxon).

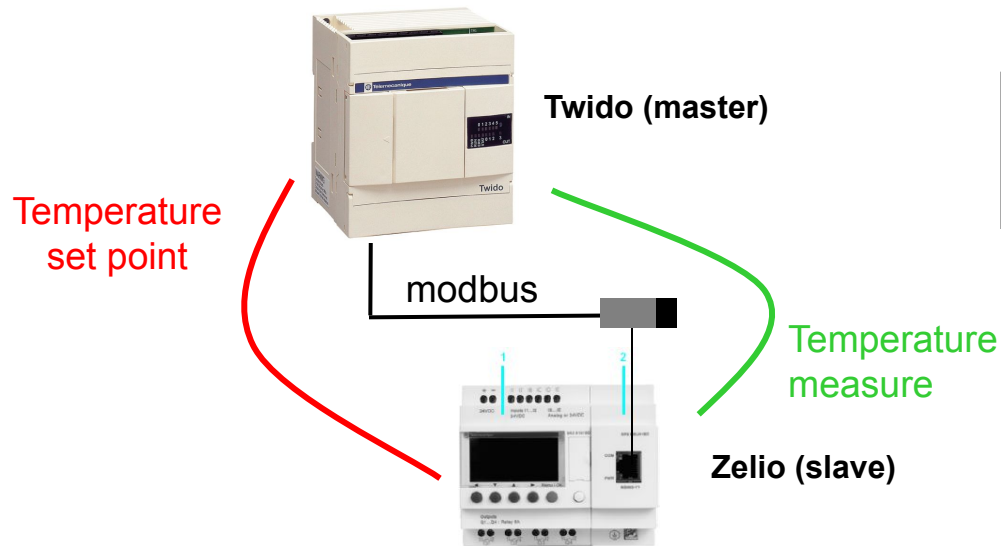

Twido (master) manages the Modbus exchanges which are transparent for Zelio Logic.

Application example

Using the input word J1XT1 to write the temperature set point and the output word O1XT1 to read the measure.

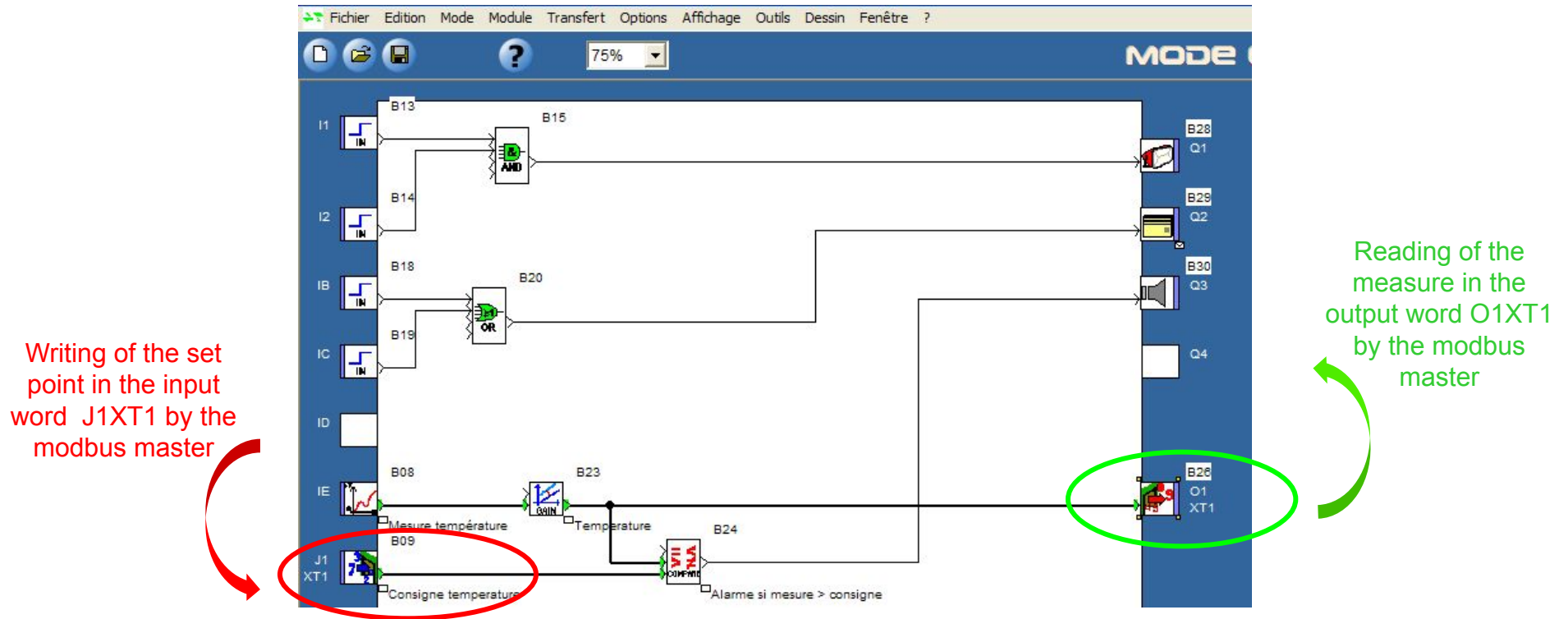

Ethernet extension presentation

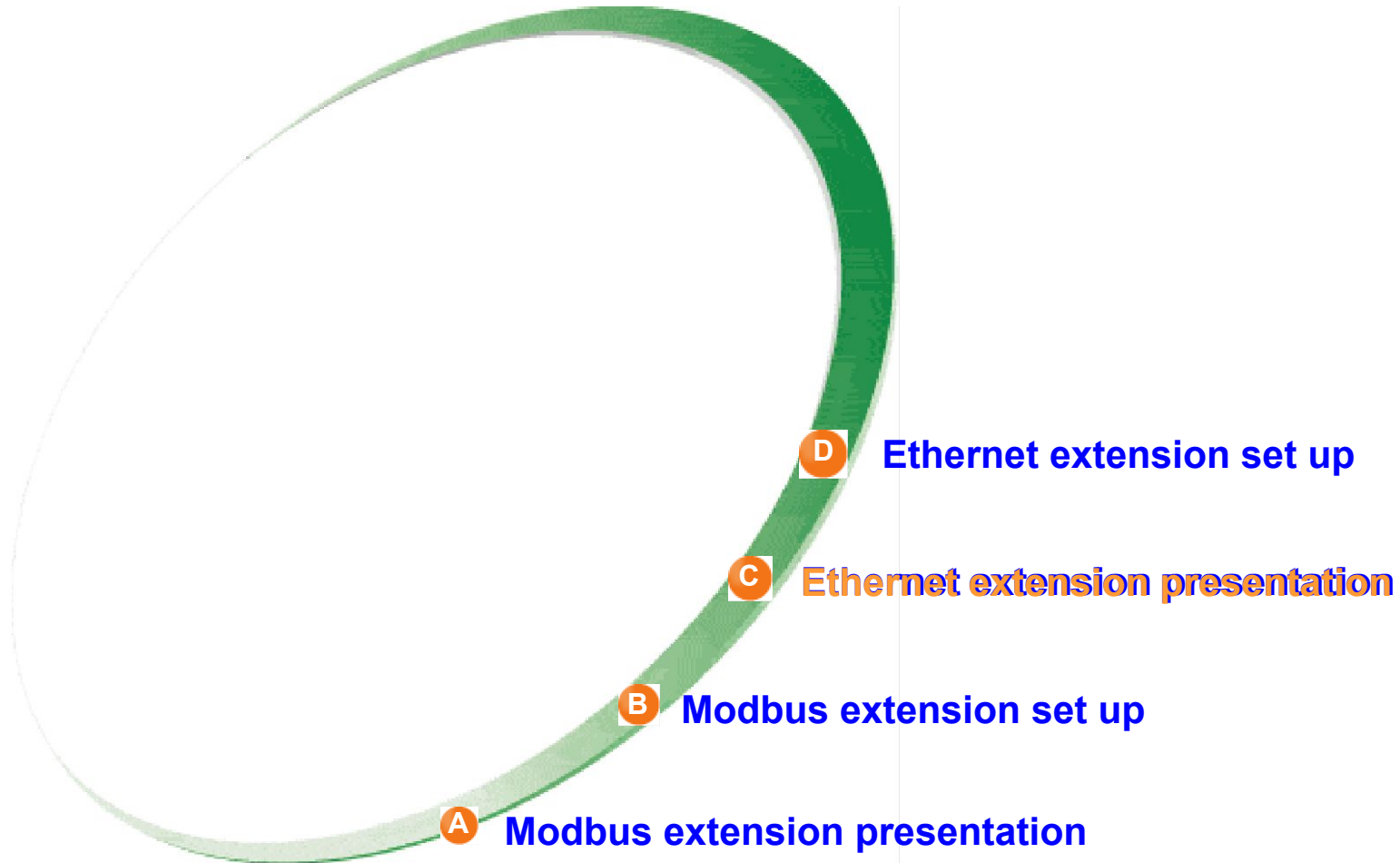

Characteristics

- Zelio logic on Ethernet via the Ethernet extension module

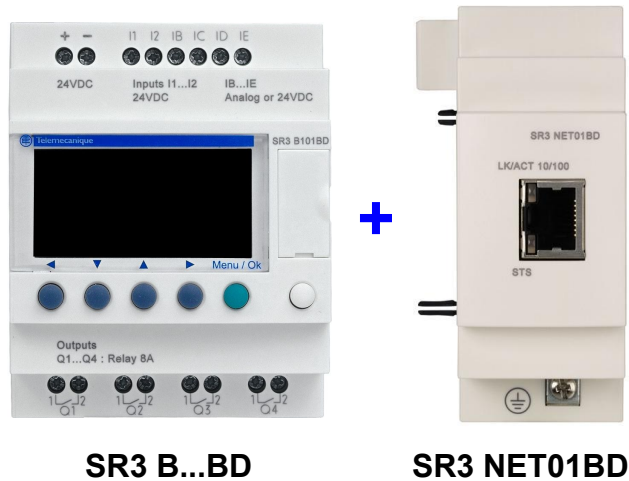

- Compatible Zelio Logic modular 24 VDC
- Connecteur RJ45 10/100 T
- Modbus TCP/IP server
- Adresse IP : acquisition static or dynamic
- Configuration : Zelio Soft 2, FBD language

Characteristics

- Modbus TCP/IP request supported
 - Reading of n register Function code = 03 (0x03)
 - Writing of simple registers Function code = 06 (0x06)
 - Writing of n registers Function code code = 16 (0x10)
 - Reading device identification Function code code = 43 (0x2B)

Description

■ Front panel

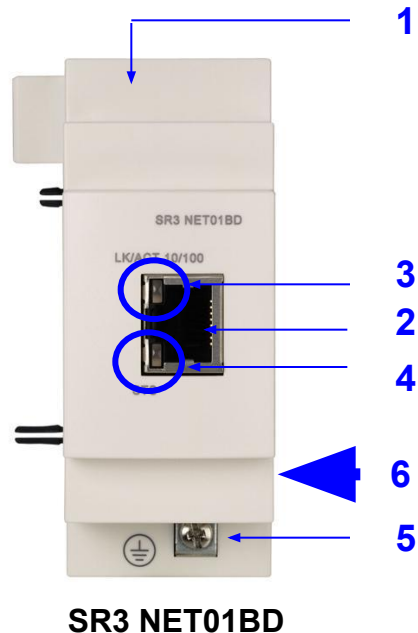

- 1 Monting : Rail 35mm, patte de fixation
- 2 RJ45 connector : Connexion on Modbus TCP/IP
- 3 Bicolor LED "LK/ACT" : Display speed COM 10/100
- 4 LED "STS" : Communication status Ethernet
- 5 Screw terminal : Ground
- 6 On the right side of the device: MAC Address (single for each device)

Module IP Address (setting factory) :
85 . 16 . X . Y (decimal code)
(X = Value of the last byte before of the
MAC Address ; Y = Value of the last byte of
the MAC Address)

Ethernet Architecture

■ Connection example

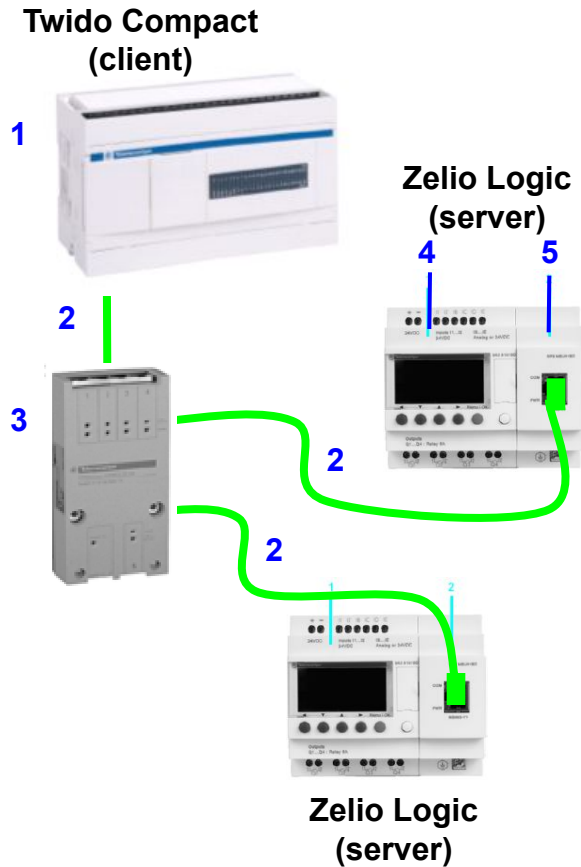

- 1 Twido compact : TWDLCAE40DRF
- 2 Ethernet cable RJ45 connector : 490 NTW000 ..
- 3 Switch conneXium 499 NES251 00
- 4 Zelio logic modular : SR3B...BD
- 5 Ethernet extension module : SR3NET01BD

Ethernet extension set up

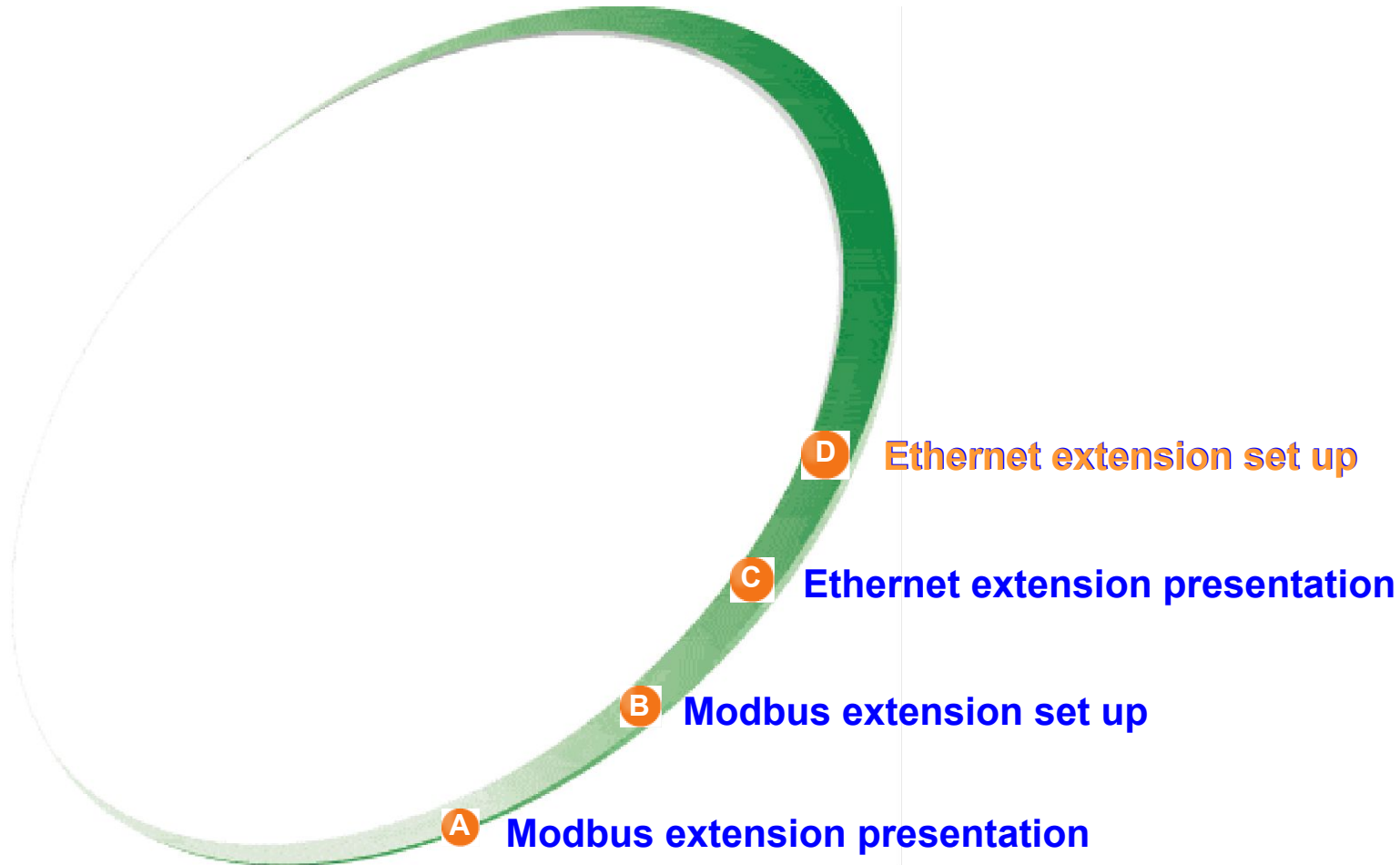

Ethernet extension configuration - Zelio Soft 2

1

Menu edition : Select "Program configuration"

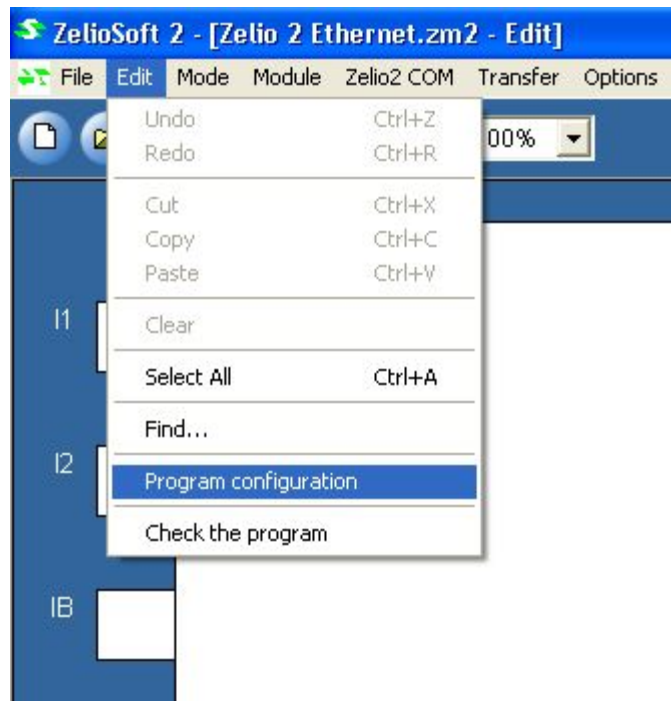

2

Menu Program configuration : Click on tab Ethernet extension

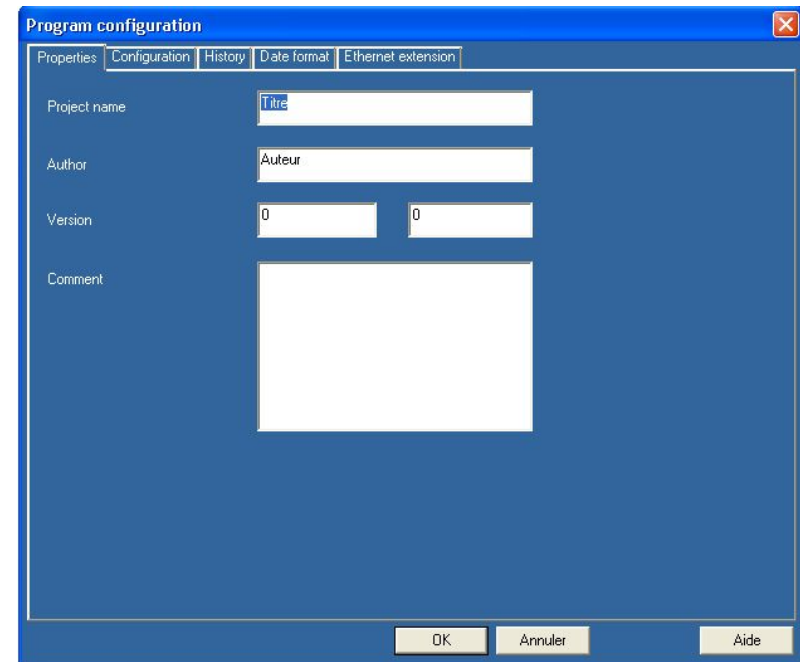

Ethernet extension configuration - Zelio Soft 2

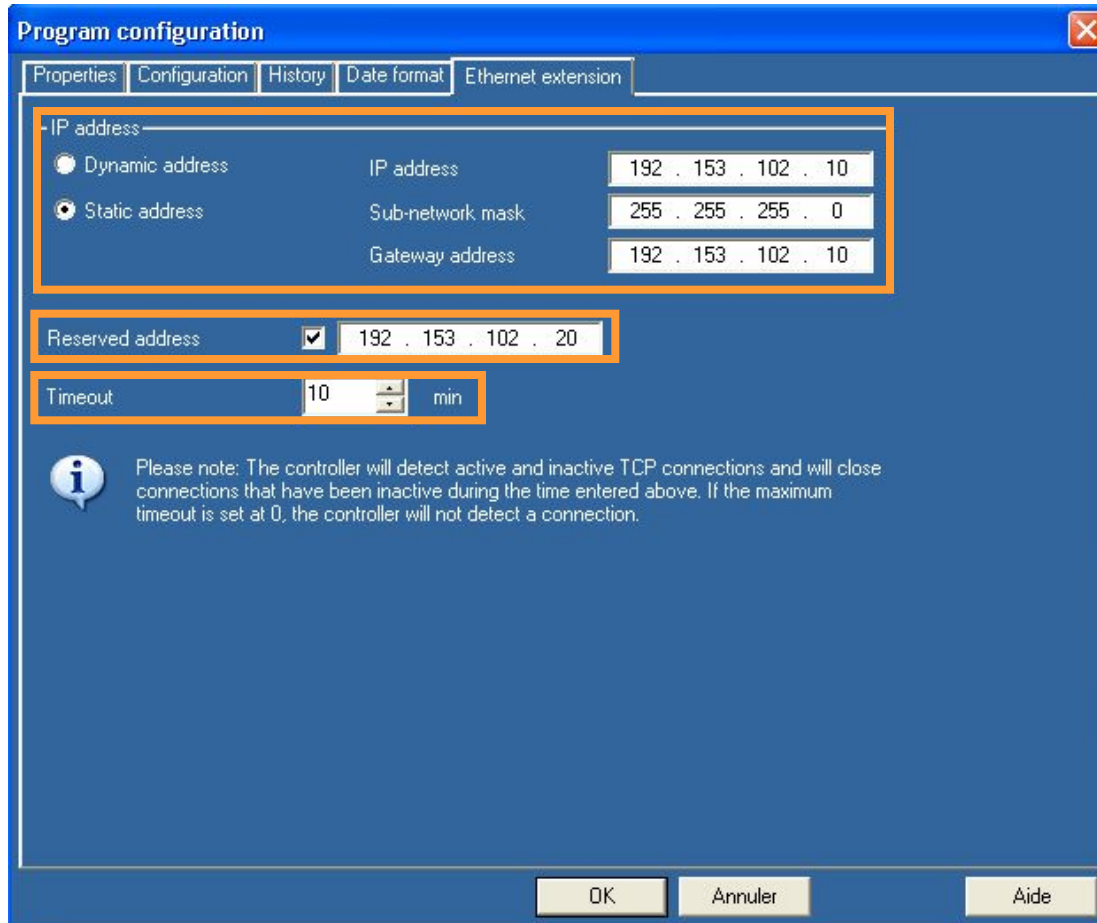

In the **IP Address** field :

- Click on **dynamic Address** if the network have a bootp server
- Otherwise click on **Static Address** and enter **IP Address**, **Sub-network mask** (here Class C network), and **Gateway address**



If the Ethernet extension must be constantly connected to a client, enter the client address in the **reserved Address** field



Modification of the **Time-out** : time after which the Ethernet extension must close an inactive connection

✓ The Ethernet extension manage until 4 connections in simultaneous.

Data Exchanges with the Modbus client

- Data words accessibles via application Zelio
 - 4 Input words : **J1XT1 to J4XT1**
 - 4 Output words : **O1XT1 to O4XT1**

Modbus TCP/IP Exchanges	Modbus function code	Modbus register	Input/Output Zelio Logic
4 Input words (16 bits)	03 (Reading n words) 06 (Writing 1 word) 16 (Writing n words)	Reg. 16 Reg. 17 Reg. 18 Reg. 19	J1XT1 J2XT1 J3XT1 J4XT1
4 Output words (16 bits)	03 (Reading n words)	Reg. 20 Reg. 21 Reg. 22 Reg. 23	O1XT1 O2XT1 O3XT1 O4XT1

Data Exchanges with the Modbus client

- Status and Clock of Zelio Logic

Modbus TCP/IP Exchanges	Modbus function code	Modbus Registers
Reading/Writing of the clock	03 (Reading of n words) 06 (Writing of 1 word) 16 (Writing of n words)	Reg. 32 : Day of the week, Second Reg. 33 : Minutes, Hours Reg. 34 : Day of the month, Month Reg. 35 : Year , Century
Reading Status of Zelio	03 (Reading of n words)	Reg. 48 : bit 0 = Run/Stop, bit 1 = Monitoring, bit 2 = Alarm, bit 3 = Error, bit 7 = Time out bit 8 à F = Alarme code

Application Example

- FBD editor screen : Data accessible by the Client

4 words J1XT1 to J4XT1 accessible in writing/reading by the client

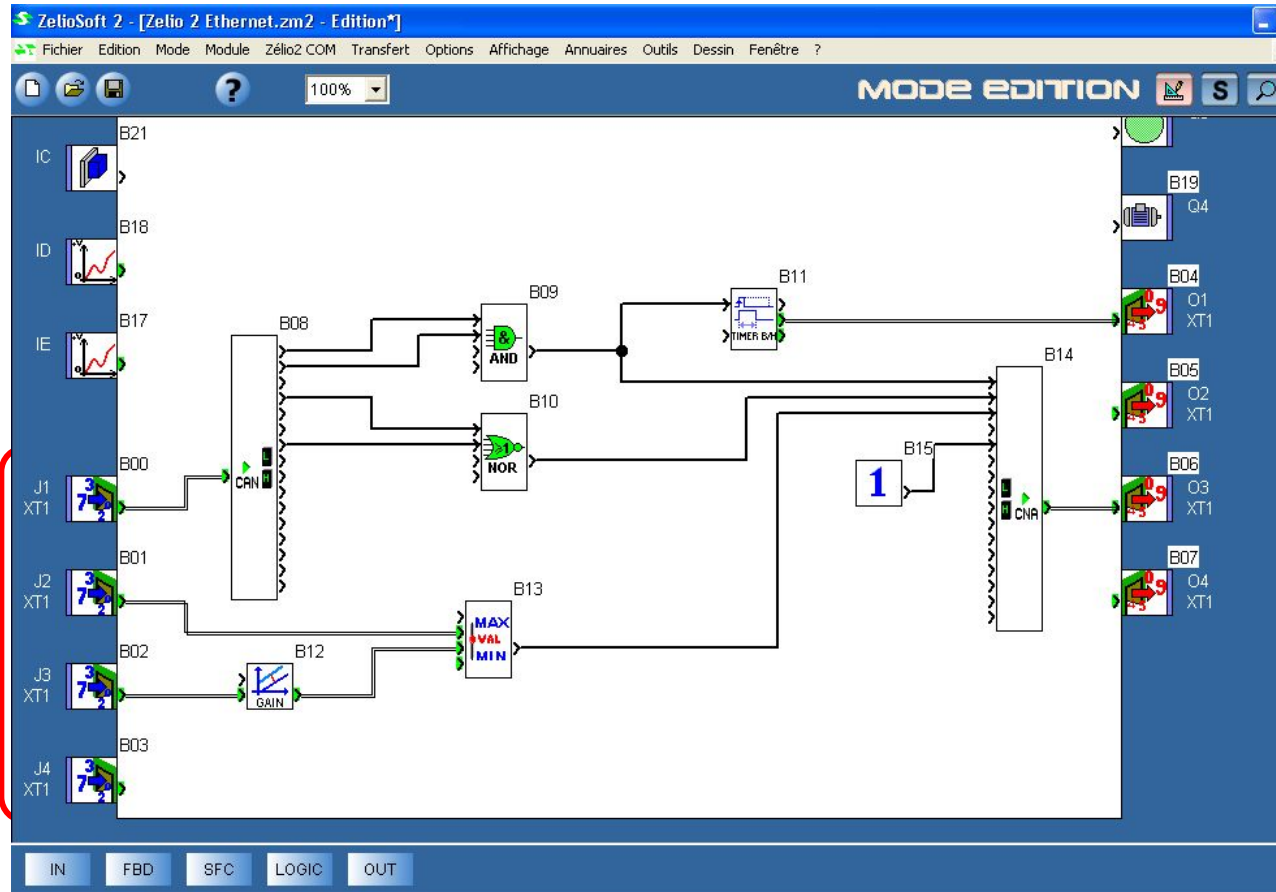
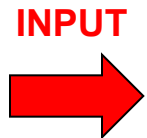

4 words O1XT1 to O4XT1 accessible in reading by the client

