

Lviv Polytechnic National University
Institute of Telecommunications, Radioelectronics and Electronic
Engineering
Department of Radioelectronic Devices and Systems (REDS)

**«The adequacy of analysis of linear
periodically-time-variable circuits by the
frequency symbolic method in the time
domain»**

DSc, Prof. **Yuriy Shapovalov,**
DSc, Prof. **Bohdan Mandziy,**
Ph.D. **Dariya Bachyk,**
B.Eng. **Marian Turyk.**

The aim and the task of the investigation

The aim of scientific research is to determine the adequacy of usage of Fourier and Laplace inverse transform to parametric transfer functions of linear periodically-time-variable circuit, that are determined by the frequency symbolic method.

To achieve the aim of the research we have to fulfil the following tasks:

1. To analyze the method of Fourier and Laplace inverse transform for further research of linear periodically-time-variable circuits in the state mode and transition mode using conjugate parametric transfer function found by the frequency symbolic method .
2. To develop the program which is intended to form a conjugate parametric transfer function of linear periodically-time-variable circuits using the frequency symbolic method and to calculate the time-dependency of output variable circuits on the basis of Fourier and Laplace transform method.
- 3 To conduct computational experiments for analysis of radio-electronic circuits in order to confirm the adequacy of our program.

Theoretical Foundations of the Frequency Symbolic Method

The mathematical model in the time domain of linear periodically time-variable circuit has the form:

$$a_n(t)x_{output}^{(n)} + a_{n-1}(t)x_{output}^{(n-1)} + \dots + a_0(t)x_{output} = b_m(t)x_{input}^{(m)} + \dots + b_0(t)x_{input} \quad (1)$$



$$\frac{1}{n!} \frac{d^n A(s, t)}{ds^n} \frac{d^n W(s, t)}{dt^n} + \dots + \frac{dA(s, t)}{ds} \frac{dW(s, t)}{dt} + A(s, t) \cdot W(s, t) = B(s, t), \quad (2)$$

where $s = j \cdot \omega$ - complex variable, t - time, $A(s, t) = a_n(t)s^n + \dots + a_0(t)$,
 $B(s, t) = b_m(t)s^m + \dots + b_0(t)$

The conjugate transfer function is defined as 

$$W(s, t) \cong \frac{w_0(s)}{ds} + \sum_{i=1}^k \left(\frac{w_{-i}(s)}{ds} e^{-j \cdot i \cdot \omega \cdot t} + \frac{w_{+i}(s)}{ds} e^{+j \cdot i \cdot \omega \cdot t} \right)$$

where k - quantity of harmonic components in a polynomial



$$X_{output}(s, t) = W(s, t) \cdot X_{input}(s)$$

Formula inverse Laplace and Fourier Transform

- $$X_{output}(s, t) = \widehat{W}(s, t) \cdot X_{input}(s) = \frac{P_1(s, t) \cdot P_2(s)}{Q_1(s, t) \cdot Q_2(s)} \quad (3)$$

$$X_{output}(t) = \sum_{k=1}^n \frac{P_1(s_k, t) \cdot P_2(s_k)}{\frac{d}{ds} [Q_1(s_k, t) \cdot Q_2(s_k)]} \cdot e^{s_k \cdot t} \quad (4)$$

where $s = j \cdot \omega$ - complex variable, s_k - the roots of equations:

$$Q_1(s, t) = 0, Q_2(s, t) = 0.$$

COMPUTER EXPERIMENTS. Example 1

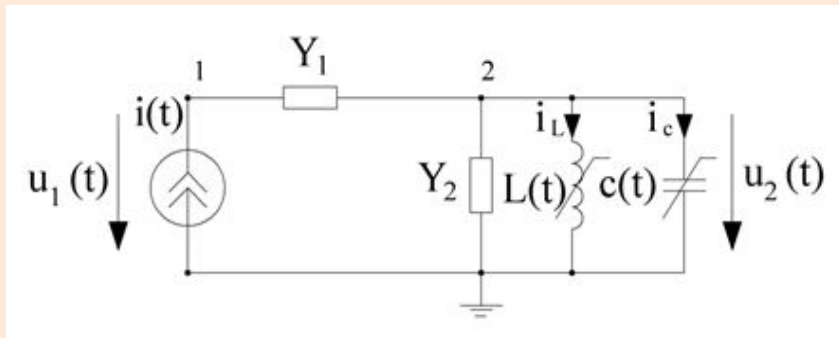

Fig. 1. Single-circuit parametric amplifier

$$c(t) = c_0 \cdot (1 + m_c \cdot \cos(\Omega t + \varphi_c)), \quad c_0 = 10 \cdot 10^{-12} \quad m_c = 0.25$$

$$L(t) = L_0 \cdot (1 + m_L \cdot \cos(\Omega \cdot t + \varphi_L)), \quad L_0 = 0.2533 \cdot 10^{-6} \text{ H}, Y_2 = 0.0004 \text{ S},$$

$$\Omega = 4 \cdot \pi \cdot 10^8 \text{ rad / s}, i(t) = 0.0001 \cdot \cos(\omega \cdot t - (\pi / 4)),$$

$$\omega = 2 \cdot \pi \cdot 10^8 \text{ rad / s}, m_c = 0.01, m_L = 0.1.$$

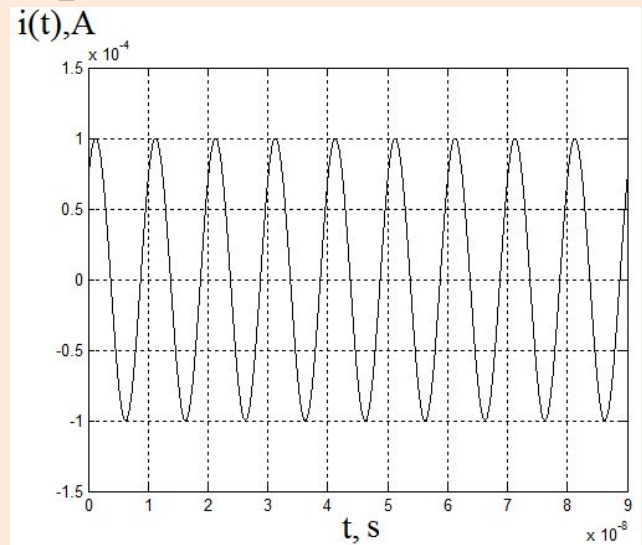

Fig.2. Time dependence of the input current $i(t)$ of the amplifier from Fig.1

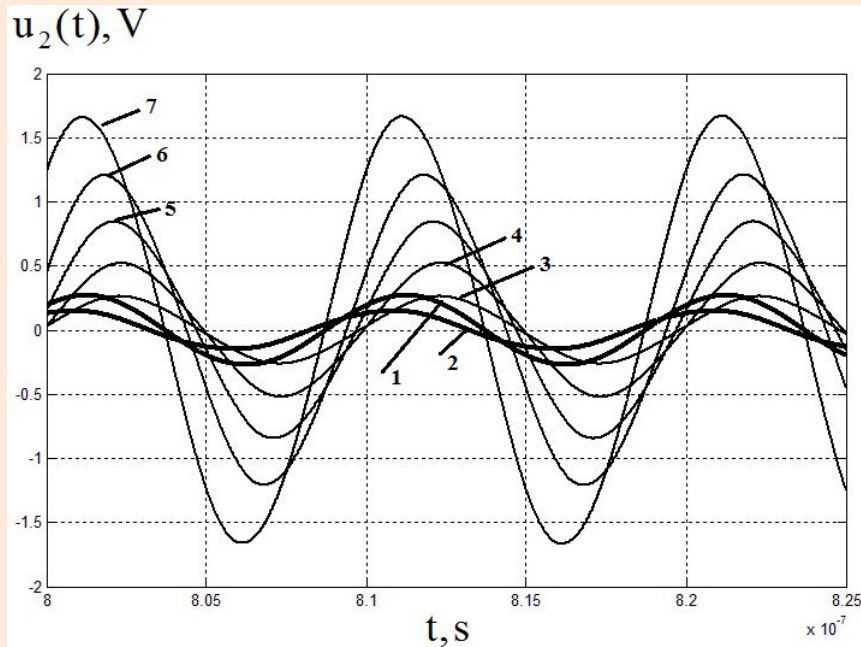

Fig.3. Time dependence of the output voltage $u_2(t)$ of the amplifier from Fig.1, obtained by SF MAOPCs for the following cases: 1- one parametric element in the circuit $c(t)$; 2- two parametric elements in the circuit $c(t)$ and $L(t)$ ($\varphi_c - \varphi_L = 0^\circ$; 3- ($\varphi_c - \varphi_L = 30^\circ$; 4- ($\varphi_c - \varphi_L = 60^\circ$; 5- ($\varphi_c - \varphi_L = 90^\circ$; 6- ($\varphi_c - \varphi_L = 120^\circ$; 7- ($\varphi_c - \varphi_L = 180^\circ$

The expression to calculate the output voltage of the amplifier of fig. 1. in the steady state:

$$U_2(s,t) = \hat{W}(s,t) \cdot I(s) = \frac{P_1(s,t) \cdot P_2(s,t)}{Q_1(s,t) \cdot Q_2(s,t)}; \quad u_2(t) = \sum_{k=1}^n \frac{P_1(s_k,t) \cdot P_2(s_k,t)}{\frac{d}{ds} [Q_1(s_k) \cdot Q_2(s_k)]} \cdot e^{s_k \cdot t}; \quad (5)$$

where s_k - the roots of equation: $Q_1(s_k) = 0, Q_2(s_k,t) = 0, I(s) = (10^{-4} \cdot (s \cdot \cos(\varphi - \omega \cdot \sin(\varphi))) / (s^2 + \omega^2))$.

TABLE 1. THE INSTANTANEOUS VALUES OF THE VOLTAGE $u_2(t)$

	0.800	0.801	0.802	0.803	0.804	0.805
	0.12908	0.14815	0.11201	0.02445	-0.06791	-0.12909
	0.12908	0.14815	0.11201	0.02445	-0.06790	-0.12903
	0.02899	0.17156	0.25789	0.23296	0.11857	-0.02895
	0.02894	0.17159	0.25784	0.23296	0.11853	-0.02892
	0.02685	0.32372	0.50730	0.47107	0.26238	-0.02671
	0.02681	0.32375	0.50732	0.47108	0.26235	-0.02677
	0.15617	0.62084	0.84094	0.70826	0.33235	-0.15628
	0.15610	0.62085	0.84090	0.70822	0.33233	-0.15625
	0.44794	1.03862	1.19504	0.88196	0.27484	-0.44867
	0.44791	1.03860	1.19507	0.88196	0.27482	-0.44864
	1.23409	1.65232	1.41933	0.69001	-0.30900	-1.23696
	1.23401	1.65230	1.41930	0.69003	-0.30906	-1.23694

Example 2.

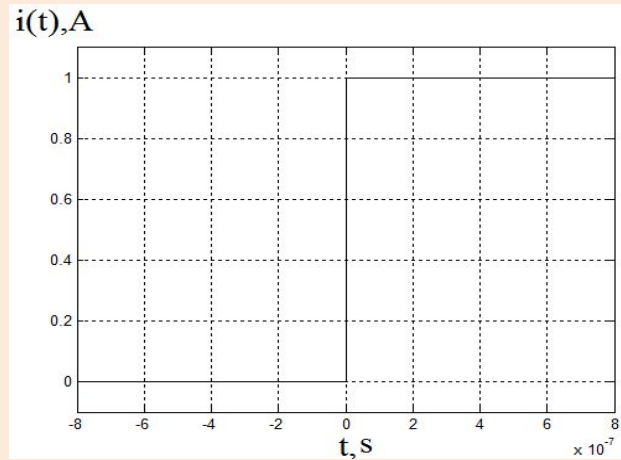
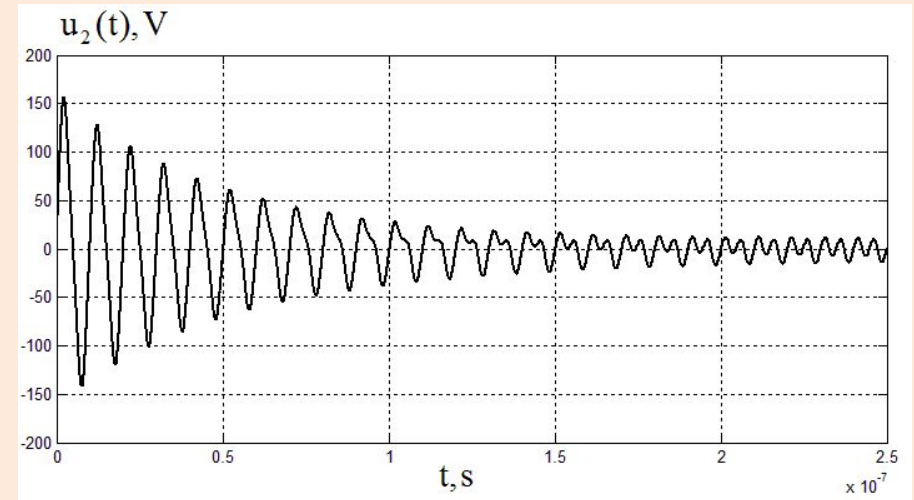
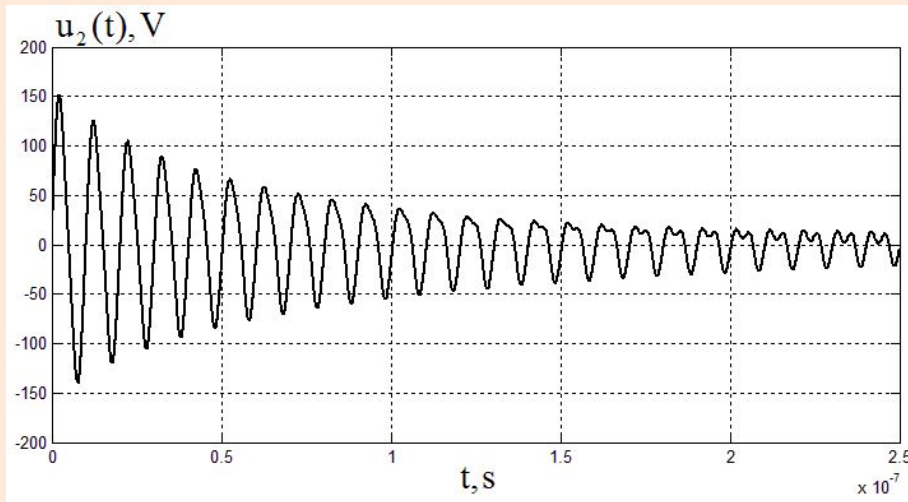

Fig. 4. Input signal as a function of the Heaviside step function $i(t) = 1(t)$



b) $m_c = 0.06$



a) $m_c = 0.1$

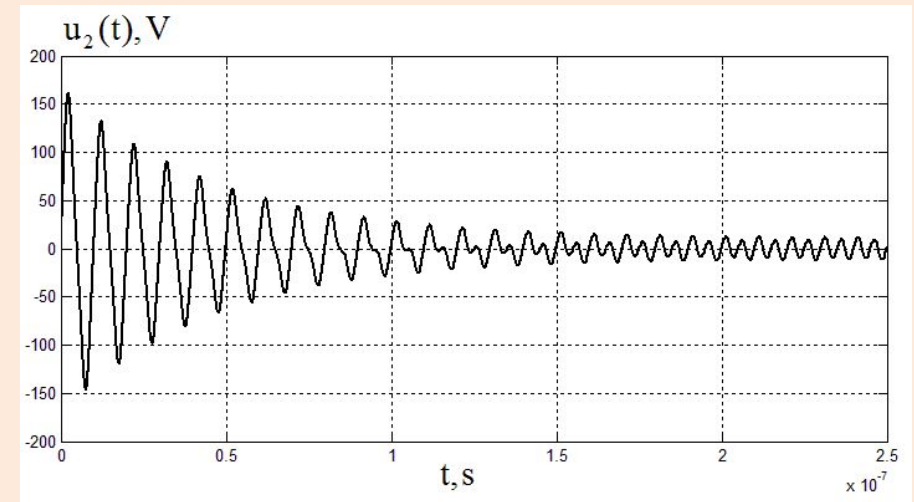

c) $m_c = 0.09$

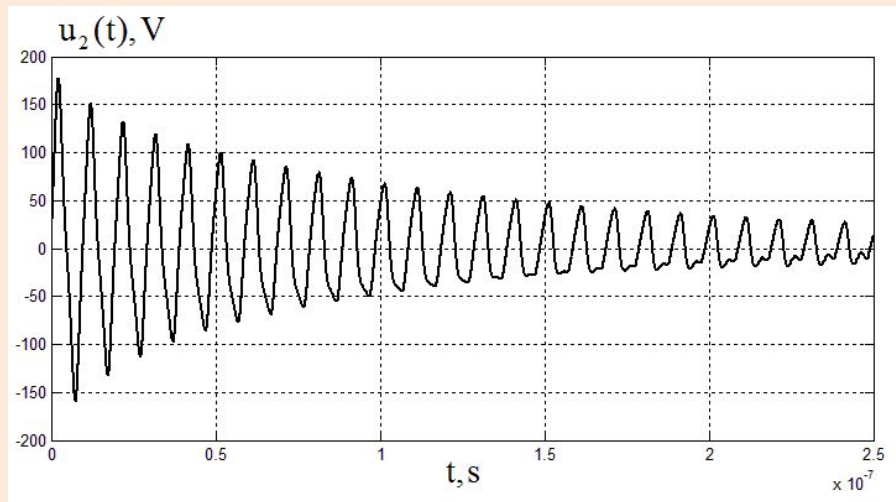

e) $m_c = 0.18$

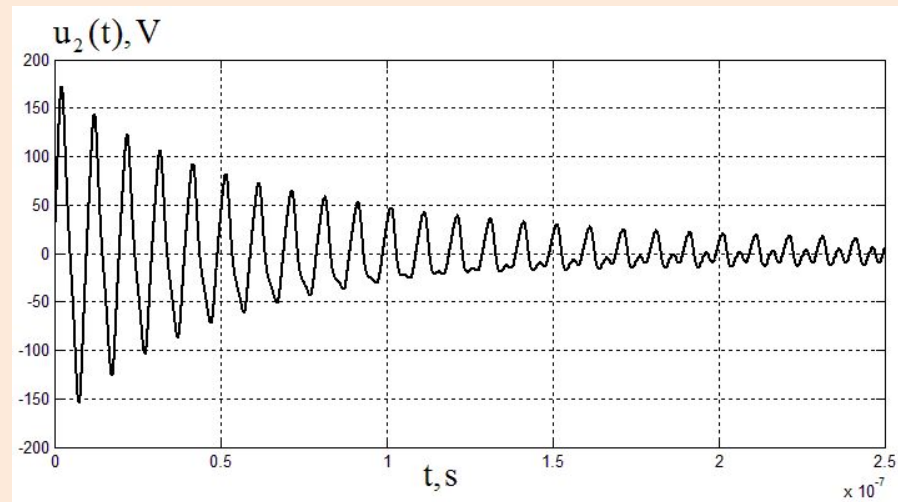

d) $m_c = 0.15$

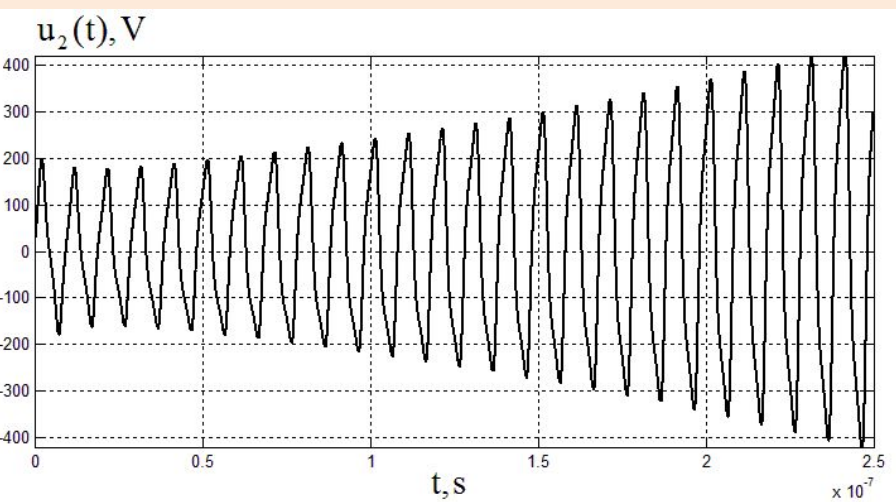

g) $m_c = 0.27$

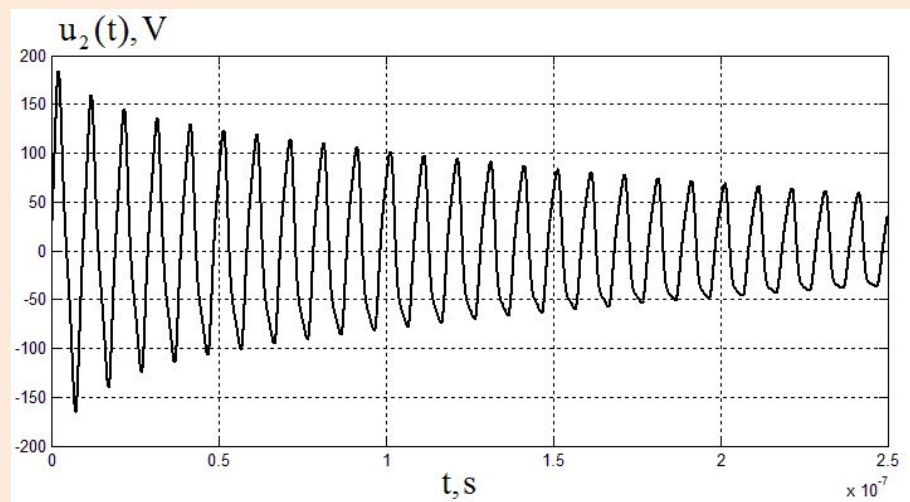

f) $m_c = 0.21$

Fig.5. Time dependence of the output voltage $u_2(t)$ of the amplifier from Fig.1 in a transition mode, when feeding the input pulse of Heaviside and for different values of modulation depth m_c

The expression to calculate the output voltage of the amplifier of fig. 1. in a transition mode:

$$U_2(s,t) = \hat{W}(s,t) \cdot I_{input}(s) = \frac{P_1(s,t) \cdot P_2(s,t)}{Q_1(s,t) \cdot Q_2(s,t)}; \quad u_2(t) = \sum_{k=1}^n \frac{P_1(s_k,t) \cdot P_2(s_k,t)}{\frac{d}{ds} [Q_1(s_k) \cdot Q_2(s_k)]} \cdot e^{s_k t}; \quad (6)$$

where s_k - the roots of equation: $Q_1(s_k) = 0, Q_2(s_k, t) = 0, I_{input}(s) = 1/s$.

TABLE 2. THE INSTANTANEOUS VALUES OF THE VOLTAGE $u_2(t)$

, μs	0.1	0.2	0.3	0.4	0.5	0.6
	0.7412	0.2015	-2.1240	-2.8182	-0.9670	2.3006
	0.7413	-0.2015	-2.1240	-2.8182	-0.9670	2.3007
	0.8580	-0.2777	-2.5651	-3.3705	-1.1295	2.7928
	0.8580	-0.2777	-2.5651	-3.3705	-1.1295	2.7928
	1.0334	-0.3912	-3.2283	-4.2028	-1.3738	3.5398
	1.0334	-0.3912	-3.2283	-4.2028	-1.3738	3.5398
	1.2091	-0.5039	-3.8938	-5.0407	-1.6192	4.2996
	1.2091	-0.5039	-3.8937	-5.0407	-1.6192	4.2996
	1.3853	-0.6158	-4.5620	-5.8854	-1.8663	5.0746
	1.3853	-0.6158	-4.5622	-5.8854	-1.8663	5.0746
	1.6208	-0.7638	-5.4582	-7.0244	-2.1992	6.1357

The program of calculation of output variables of linear periodically-time-variable circuits based on Laplace and Fourier Transform

```
clc;
clear all;
close all;
clear;
pack;
syms t s C0 L Y m Omega koef t w
%% Параметри елементів досліджуваного кола;
DigitsInVpa = 12; %% вибір точності числових розрахунків, кількість знаків після коми;
load('data'); %% Завантажемо з файлу TransFunc спряжену параметричну передавальну
функцію
load([CurrentDir, 'data.mat']);
OutputFilePath=[CurrentDir, 'data.mat'];
W=TF{7,4};
w=2*pi*10^8; %% задаємо частоту вхідного сигналу
W1=factor(W);
[P1,Q1]=numden(W1) %% виділяємо окремо чисельник та знаменник спряженої
параметричної передавальної функції
CoefOfPoly1=sym2poly(Q1);
pz1=roots(CoefOfPoly1);
pz1=vpa(pz1,DigitsInVpa) %%% обчислюємо корені полінома знаменника спряженої
параметричної передавальної функції
fi=-pi/4; %%% задаємо фазу вхідного сигналу
Хор_out01=0.0001*(s*cos(fi)-w*sin(fi))/(s^2+w^2); %%% задаємо зображення за Лапласом
вхідного сигналу
```

```

Xop_out02=factor(Xop_out01);
[P2,Q2]=numden(Xop_out02); %% виділяємо окремо чисельник та знаменник зображення за
Лапласом вхідного сигналу
CoefOfPoly2=sym2poly(Q2);
pz2=roots(CoefOfPoly2);
pz2=vpa(pz2,DigitsInVpa) %% обчислюємо корені полінома знаменника зображення за
Лапласом вхідного сигналу
%%підставляємо одержані корені у формулу перетворення Лапласа
X_out_p=((P1*P2)/(diff(Q1*Q2,s,1)))*exp(s*t);
X_out=0;
for n=1:18 %%кількість коренів pz1
X_out_sub11(n)=subs(X_out_p,s,pz1(n));
X_out11=X_out+...
X_out_sub11(n);
end
X_out=0;
for k=1:2 %%кількість коренів pz2
X_out_sub22(k)=subs(X_out_p,s,pz2(k));
X_out22=X_out+...
X_out_sub22(k);
X_out=X_out11+X_out22;
end
save(OutputFilePath,'X_out','-append');

```

CONCLUSIONS

- **The coincidence of the results obtained by the SF MAOPCs and the program Micro-Cap7.0, demonstrates the adequacy of applying the inverse Fourier and Laplace transform, and for the study of linear periodically-time-variable circuits in the steady and transient conditions in the environment of the SF MAOPCs.**
- **The Frequency symbolic method means that to obtain accurate values of input signal of linear periodically-time-variable circuits it should be taken into consideration a sufficient number of harmonic components in the approximation of the parametric transfer function. Insufficient amount of harmonics taken into consideration in the approximation can lead to receiving inaccurate results.**

Thank you for attention