



---

# *Технология отделки одежды*

*Основы технологии отделки одежды*  
**5 уроков**

Проектирование  
10 уроков

Защита проекта  
**1 урок**

---

# ЖАБО

**Отделка платьев, блузок или детских изделий в виде оборок из ткани или кружева, которые крепятся к горловине изделия в области груди. Жабо может быть разной конфигурации и изготавливаться со складками, сборками или рюшами.**

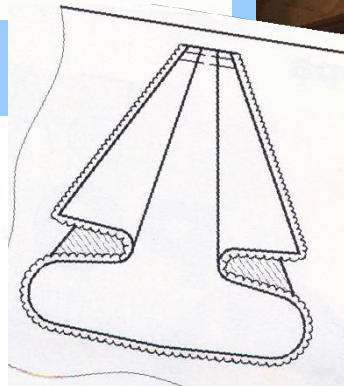
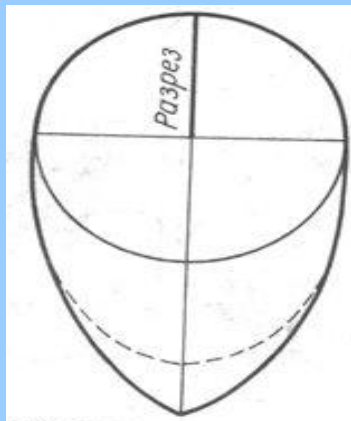
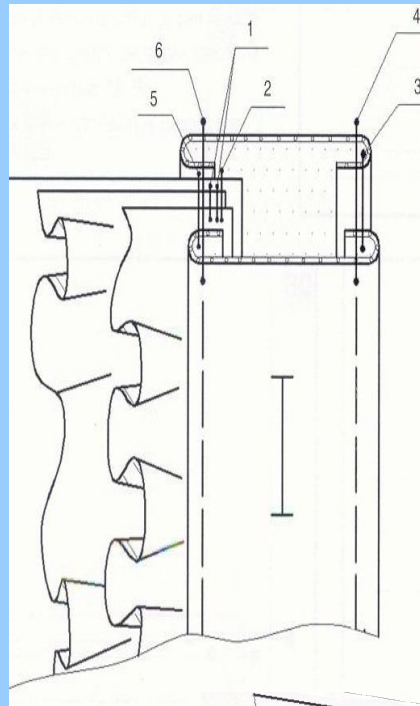

# КОКИЛЬЕ

*Кокилье является разновидностью жабо. Выкраивают кокилье только по спирали. Оно может быть одно-, двух- и многослойным, съёмным или пришитым.*

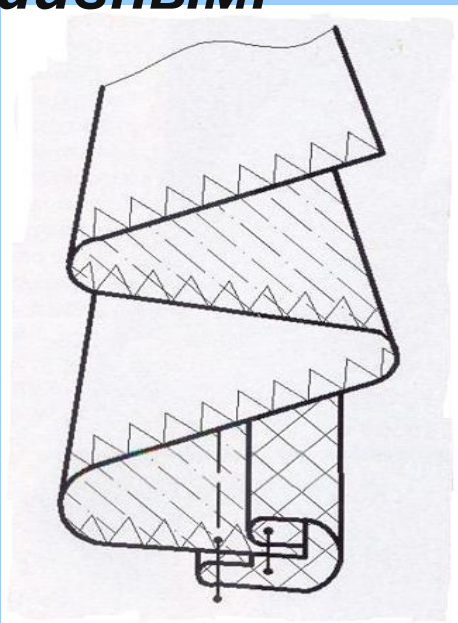
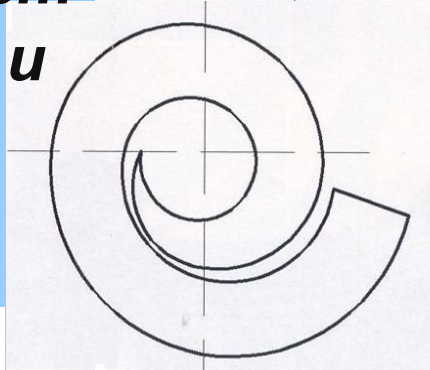
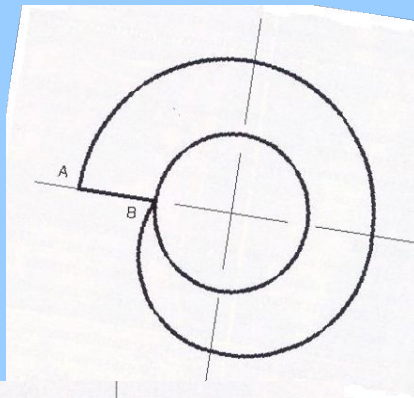

# ОБОРКА

**Оборка - это косая или поперечная полоска ткани, с одной стороны собрана на нитку, а с другой - подшита узким швом. Ширина оборок может быть от 2 до 25 см.**

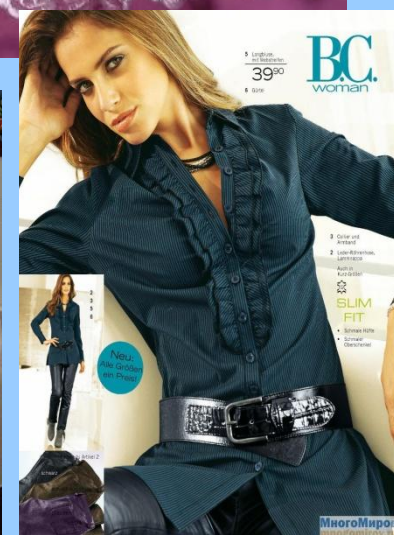
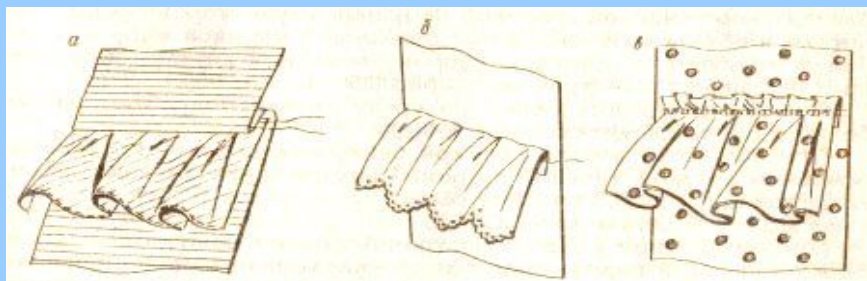
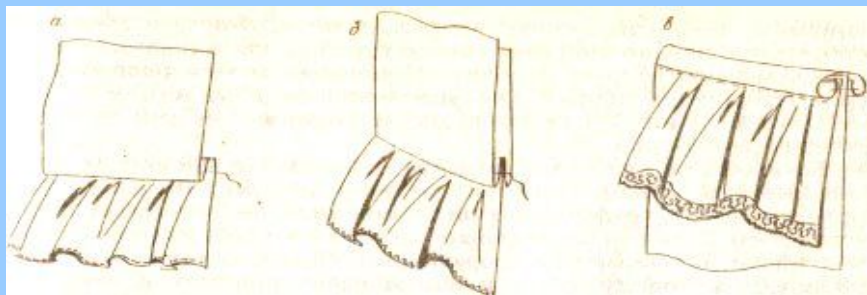
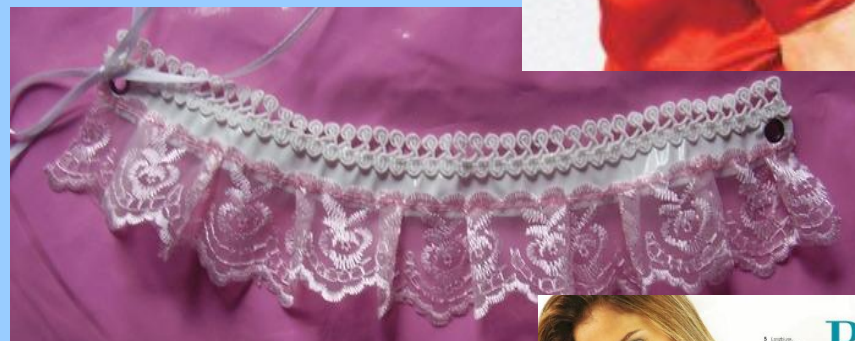

# ВОЛАНЫ

Воланы выполняются в форме полукруга. Нижний срез обрабатывают на швейной машине или вручную или окантовывают швом

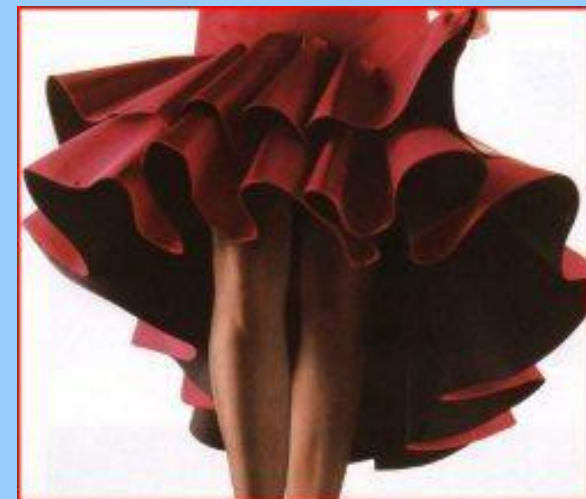

# ВОЛАНЫ



Valentino



Carlos Miele



D&G



Halston

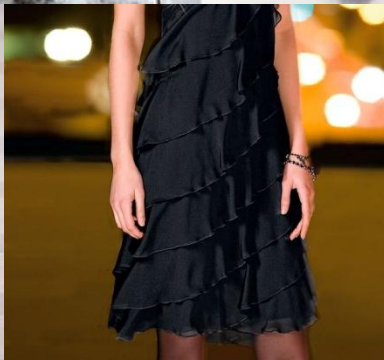

# РЮША

*Рюша - полоска ткани с обработанными краями, собранная посередине в сборку, заложенная в складку или плиссированная.*

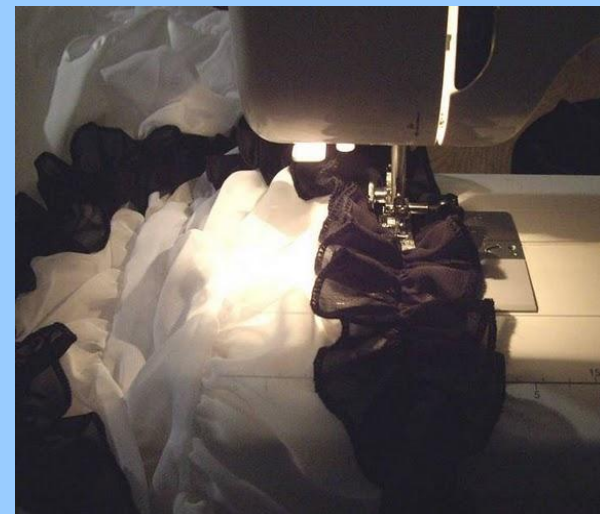

# РЮША





# БАНТЫ

**Лента или тесьма, сложенная петлями или собранная и перетянутая посередине. Вид узла с свободно выпущенными петлями**



# БАНТЫ

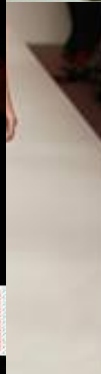
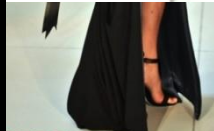
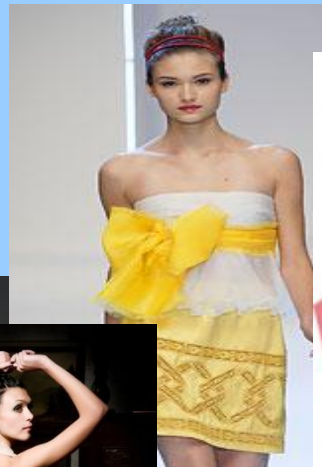

# БУФЫ

**Вид пышных сборок, образованный несколькими строками строчек. Буфы бывают со шнурком, обычные, со складками, хаотические, комбинированные, вафли**

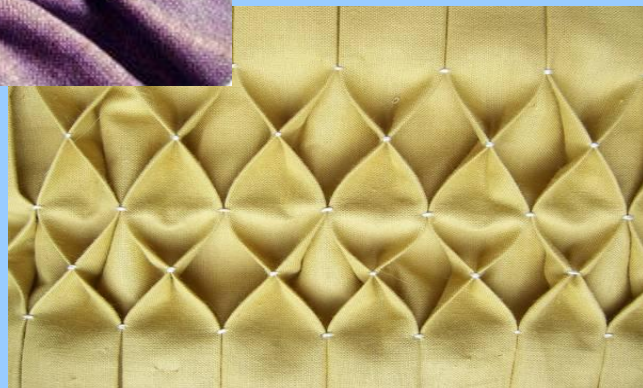

# БУФЫ

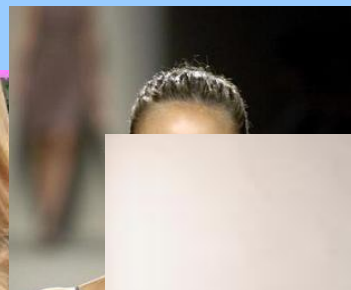

# КРУЖЕВО

**Ажурная ткань или декоративная лента; образуется в результате плетения нитей различными способами; от техники выполнения подразделяется на: сетчатое, шито иголкой, плетеное на коклюшках, крючком, фриволите.**

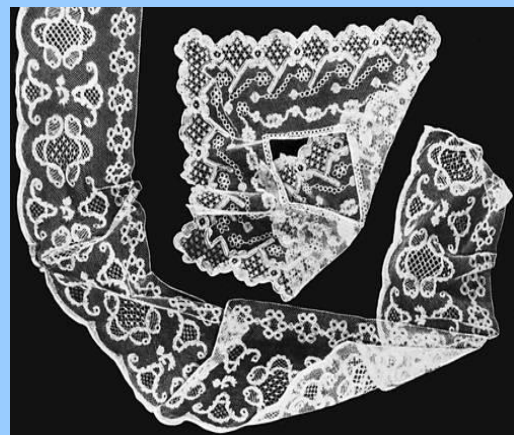



# ТЕСЬМА

*Это особая декоративная ткань, выпускается в виде полос или лент различной ширины. Тесьма используется, как правило, для конечной обработки уже готовых изделий.*



# ШНУРЫ

*Изделия из крученых нитей:  
круглые, плоские,  
плетеные, вязанные, витые.  
Используют для отделки  
одежды, головных уборов,  
для завязывания и  
закрепления деталей*





# СУТАЖ

**Вид плоского шнура для отделки и плетения; состоит из двух шнуров с общим переплетением и углублением посередине для удобства прокладки строчки**



# СУТАЖ



[www.secondstreet.ru](http://www.secondstreet.ru)

# РУЛИК

*Это полоска ткани, скроенная по косой, шириной 2 -2,5 см; просроченная и вывернута с помощью иглы. Используют для изготовления петель, пуговиц и для украшения (узоры на воротах, карманах)*

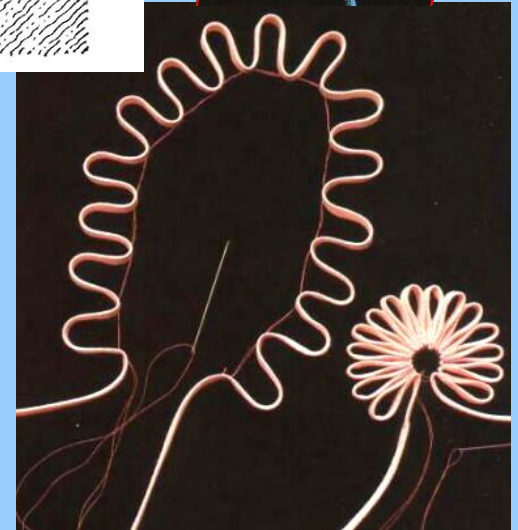
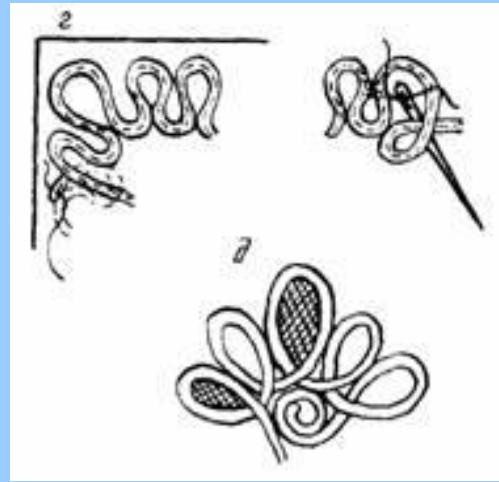
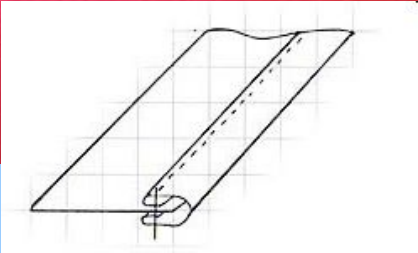
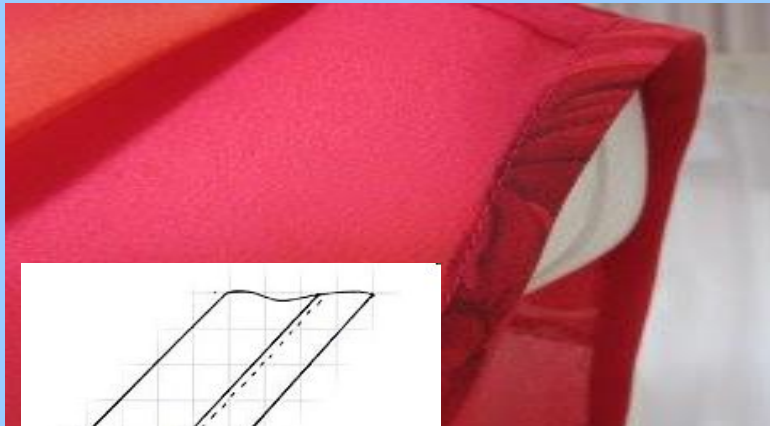
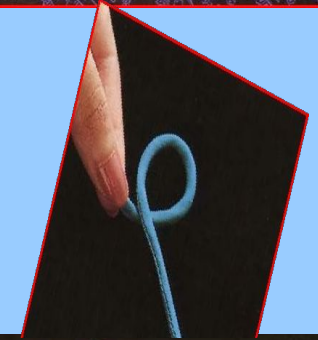
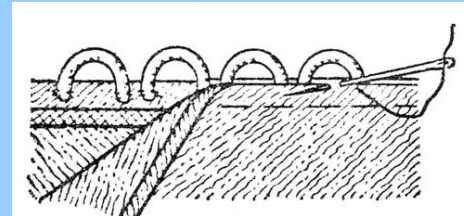

# КАНТ

**Узкая цветная полоска, оторочка по краю или шву одежды (выкраивается по косой, пришивается к детали таким образом, чтобы кант выступал на 2-3 мм, может протягиваться шнурок). Используется для отделки блузок, платья, форменной одежды.**

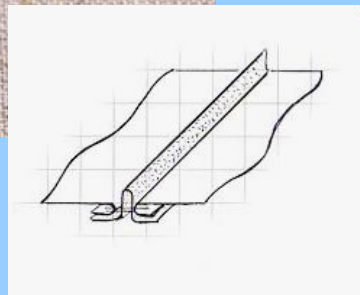

# KAHT



# ПОМПОНЫ

*Помпон - это шарообразная украшение с любых ниток (фр. Pomme - пышность, торжественность).*

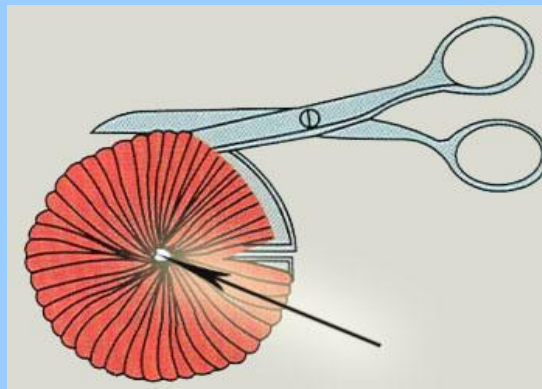
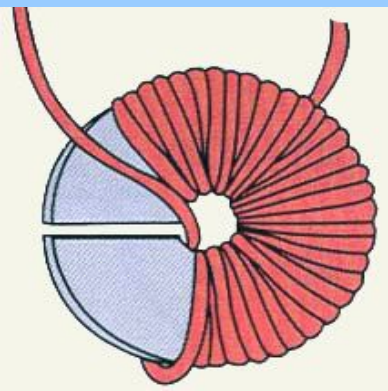
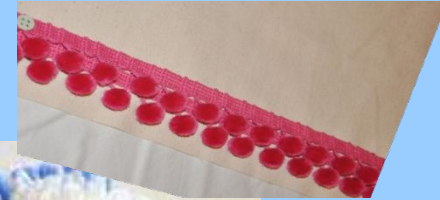
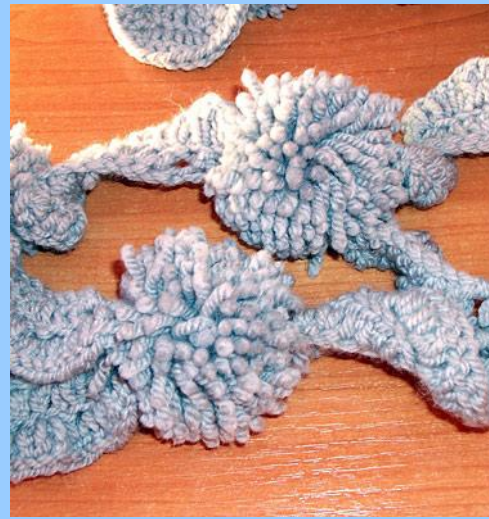

# ПОМПОНЫ

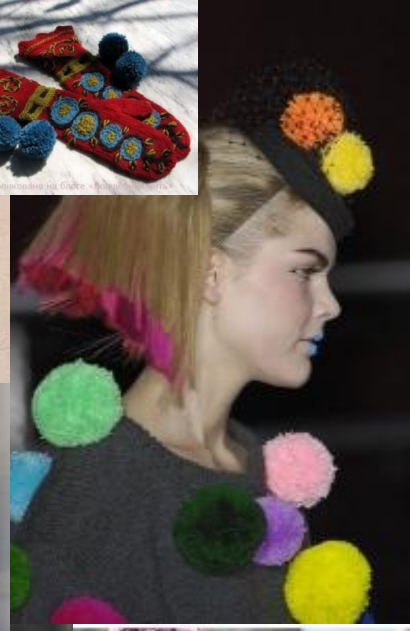

# БАХРОМА

**Бахрома (араб. «Mucharramat» - кружева) - тесьма с висящими с одной стороны нитями, мягкими волокнами, шнурками или любыми другими подвесками.**

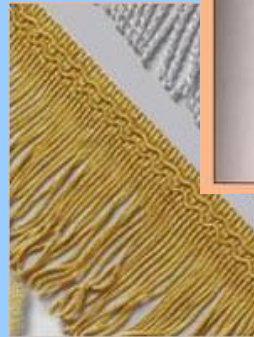
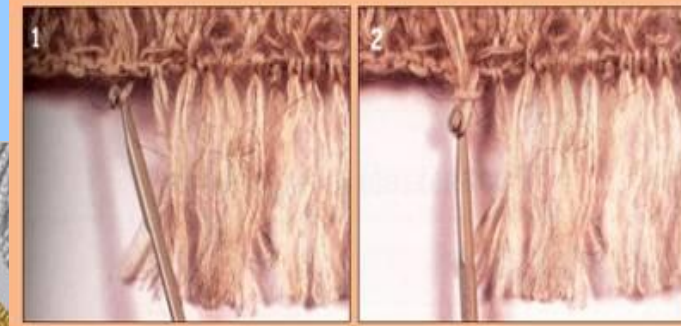



# БАХРОМА



# КИСТИ

*Кисти - это пучок нитей, шнуров, и т. д. закрепленных в одно целое.*

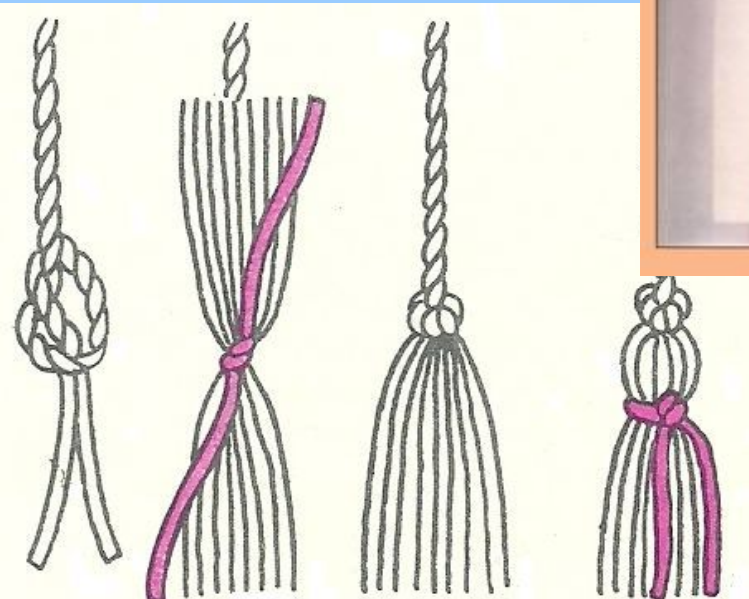

# КИСТИ



# РУЧНЫЕ ШВЫ

Вышивкой называют технику украшения текстильного или иного изделия с помощью различного вида стежков, а также жемчугом, бисером, камнями.

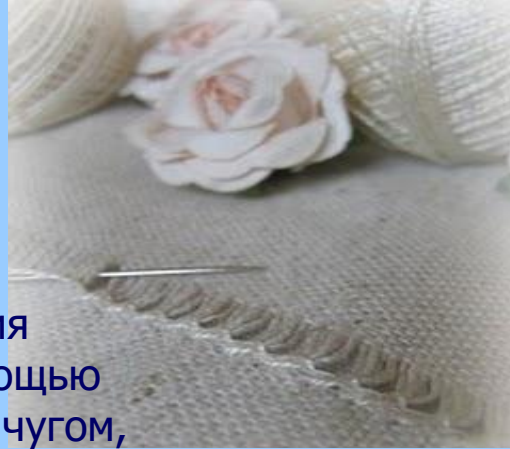

# МАШИННАЯ ВЫШИВКА



# ВЫШИВКА БИСЕРОМ

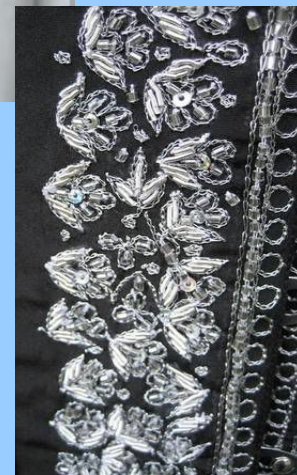

# АППЛИКАЦИЯ

*Вид отделки, когда на ткань, трикотаж, кожу, замшу называют узор или орнамент, выполненный из другого материала (накладные шитья)*



# ИСКУССТВЕННЫЕ ЦВЕТЫ





# ПЛЕТЕННЫЕ ЭЛЕМЕНТЫ



# МАКРАМЕ

**Это один из видов декоративно-прикладного искусства, основой которого является плетение (завязывание) узелков.**

**Макраме в переводе с арабского означает тесьма, кружево, а с турецкой - шарф, салфетка с бахромой.**



# МАКРАМЕ



Сил вам и  
творчества!

