

Networks and the effects of using them

The course syllabus states that you should be able to:

4.1 Networks

- Understand how a router works and its purpose
- Understand the use of other common network devices, including: network interface cards, hubs, bridges, switches, modems
- Understand the use of WiFi and Bluetooth in networks
- Understand how to set up and configure a small network, including: access to the internet, the use of a browser, the use of email, access to an ISP
- Understand the characteristics and purpose of common network environments, such as intranets and the internet
- Understand the advantages and disadvantages of using different types of computer to access the internet

4.2 Network issues and communication

- Describe security issues regarding data transfer
- Network communication

This section is broken down into 8 parts.

Part 1:
Computer Networks Introduction



Part 2:
Types of Computers on a Network



Part 3:
Types of Networks



Part 4:
Network Devices



Part 5:
Internet and Intranet

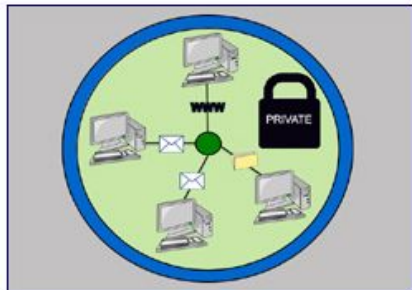

Part 6:
Using different computers to connect to the internet



Part 7:
Wi-Fi and Bluetooth in Networks



Part 8:
Setting up a Small Network

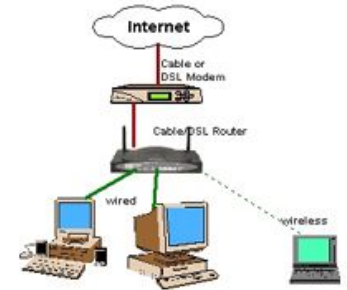

An Introduction to Computer Networking

Types of Computers found on a network

In this section we will discuss what networks are, including **advantages** and **disadvantages** of using them.

There are two types of computers that make up a network:

- Servers
- Clients.

In this section we will discuss the features of both.

Key Concepts of this section:

- # Understand what a **network** is.
- # Know **what** networks enable us to do.
- # Be able to **describe** advantages and disadvantages of setting up a computer network.
- # Understand that there are **two types** of computers found on a network.
- # Know the **difference** between a **server** and a **client**.
- # Be able to **describe** the **features** of a server computer and a client computer.

An Introduction to Computer Networking

What is a computer network?

- # A computer network consists of **2 or more** computers or electronic devices such as printers that have been **linked together** in order to **share data**.
- # Networks can **vary in size**, for example:
 - Home/school networks can consist of only a **few linked** computers
 - Huge networks (**like the internet**) can consist of **billions** of computers.

Computers not connected to a network are known as 'stand-alone' computers.

What do networks enable us to do?

- # Networks allow users to:
 - Share files
 - Send emails to each other
 - Share resources (**like printers or scanners**).

How are networked computers joined together?

- # Computers on networks are usually connect using:
 - Cables (**if the computers are linked together in the same room/building**)
 - Radio signals (**Wi-Fi**)
 - Telephone lines and satellites (**for long-range connections**).



Key Words:

Network, Resources, Linked, Communicate.

Examples:



A network is two or more computers joined together.

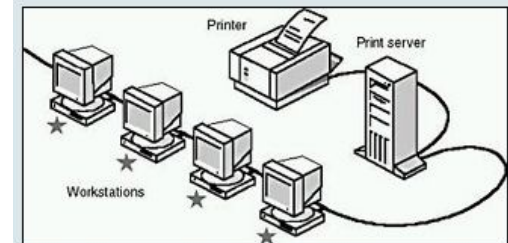

Computers on a network can share the same printer.



Advantages and disadvantages of computer networks:

Advantages of computer networks

Connecting computers together on a network offers some advantages:

1. Resources such as **printers**, **scanners** and **internet** can be **shared**
2. Files and data can be **shared**
3. Easy to **communicate** with people on the network
(**email**, **messaging**, **video-conferencing** etc)
4. We can access our data from **any computer**
5. Data can be **backed up** to a separate computer for security
6. Network administrator can **control** the network (**changing passwords**,
monitor the internet etc)

Connecting computers together on the internet offers the following advantages:

1. Access **huge** amount of information and files
2. Communicate with people **around the world** (**msn**, **Skype** etc)
3. Access large amounts of media and entertainment
(**like music**, **YouTube videos** etc)
4. Use on-line services like **online shopping** and **banking** etc

Disadvantages of computer networks

Computers connected to a network can run into problems such as:

1. If **part** of the network **fails** (i.e. a network cable is severed) – this can cause the whole network to **break down** (data can't pass through the damaged cable)
2. Viruses can **spread** across the network very **easily** and **quickly**
3. If a computer on the network is **hacked** into then all other computers are **prone** to attack
4. Networks that use **too few printers** can see printing **queues** develop (due to the amount of people trying to print)

Computers connected over the internet have a different set of disadvantages:

1. We are very prone to **virus** and **spyware infection** from other internet users
2. We are open to '**phishing**' and other **scams** which target internet users for **personal details** such as bank numbers etc
3. We can leave ourselves and our children exposed to **undesirable** material

Types of network computers

- # There are **two** types of **computers** that make up a **network**:
 - Servers
 - Clients.

What is a server computer?

- # Servers are **powerful computers** that provide '**services**' to the client computers on the network.

Servers **control** the network and tell the client computers what to do.

- # Some services that server computers provide to client computers are summarised in the table below:

Servers provide the following services:		
Providing central storage	➔	Where all users of the network can access the same data . (like the shared: drive in a school)
Sharing devices	➔	Printers and scanners can be shared among client computers. (each client computer can access the same printer - saves money)
Providing network security	➔	The server makes sure that only people with valid usernames and passwords can log onto client computers on the network.
Sharing internet connections	➔	The same internet connection can be shared amongst client computers using a router .





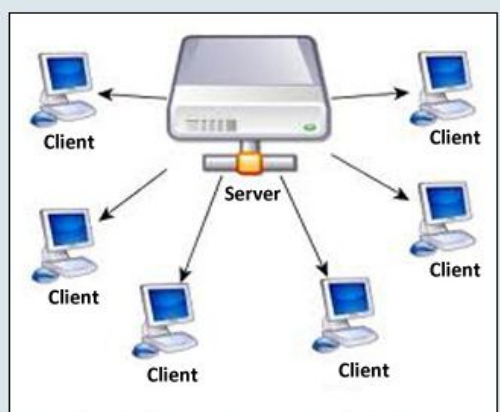

Server computers are very powerful and expensive.



Client computers are individual computers that connect to a server. This forms the network.

The different types of servers:

- # There are different types of server computers. These are summarised in the table below:

File servers		Gives network users a place to save and load their data and files .
Application servers		Allow computers on the network to run and use applications software that are stored within the server .
Printer servers		Controls how printing on the network takes place. For example: the print server will create print queues to decide the order in which printing takes place.
Proxy servers		Used as a kind of security device between client computers and the internet .

Note:

In order to do all of these things, servers must be very **powerful**. This is why they are much **more expensive** than **client computers**.



Servers allow client computers to share one printer.



Servers manage network security such as requiring usernames and passwords for people logging onto client computers.

What are client computers?

- # A client computer is a **normal computer** (a desktop PC or laptop for example).
- # A client computer is an **individual computer** that is used perform **everyday tasks** and to access **information** and **programs** from the **server**.
- # The image below shows how a client computer can be used to access the internet:

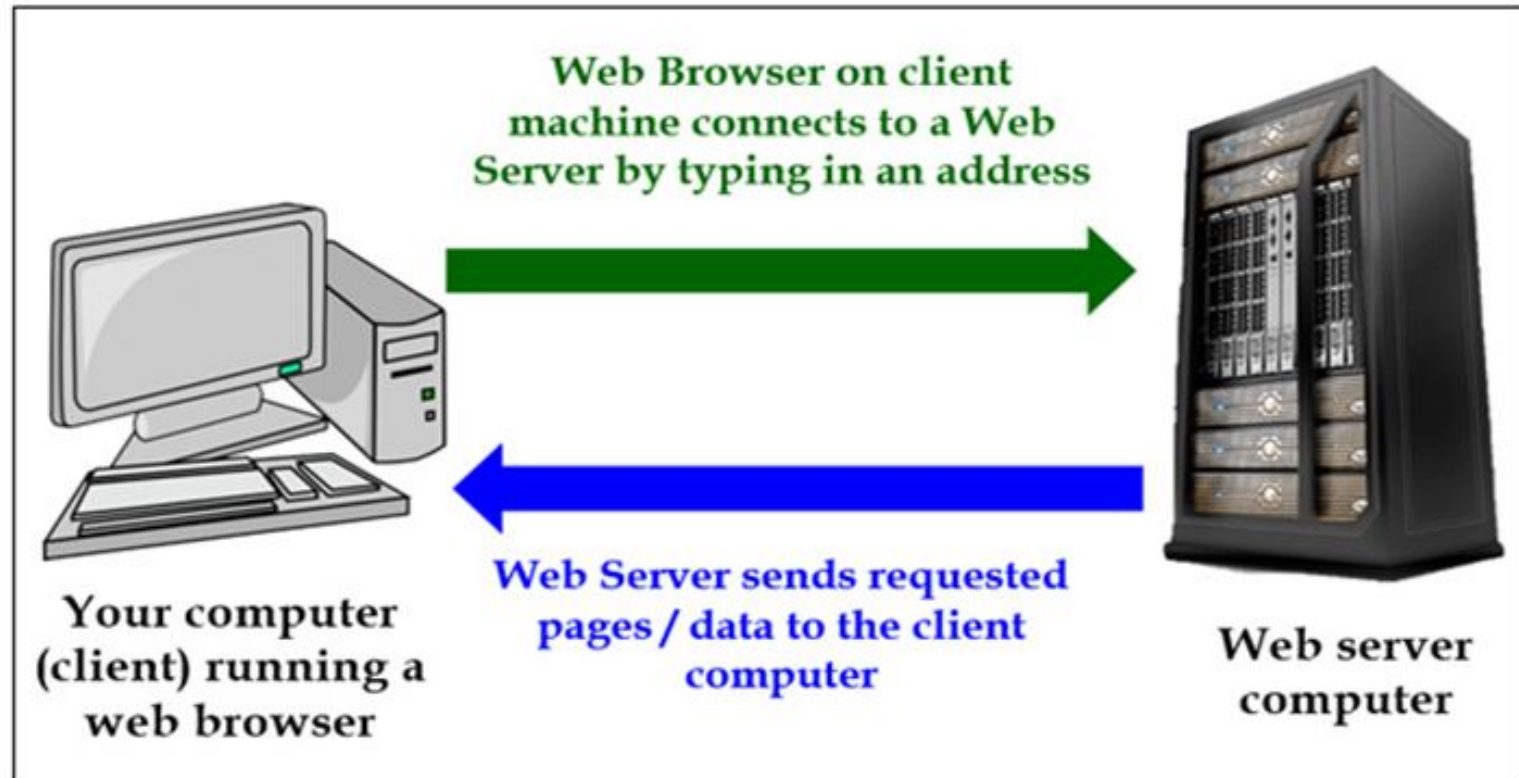



Client computers are everyday computers that we use to perform everyday tasks.



There are different types of servers - web servers for example.

The different Types of Networks

There are different **types** of **computer networks** and they all have their **advantages** and **disadvantages**.

In this section we will discuss the features each type.

Key Concepts of this section:

- # Understand that there are **four types** of computer networks.
- # Know the **features** of each type of computer network.
- # Be able to **describe** the **advantages/disadvantages** of each type of computer network.

Types of computer networks

There are four main types of computer networks:

- [LAN](#) (local area networks)
- [WLAN](#) (wireless local area networks)
- [WAN](#) (wide area networks)
- [Bluetooth](#).

We will discuss the **features** of each network type, as well as their **advantages/disadvantages** below:



Key Words:

LAN, WLAN, WAN, Bluetooth.

Examples:

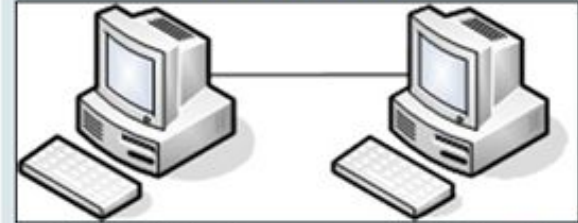

A network is just two or more computers joined together.

1 Local Area Networks (LAN)

Local area networks (or LAN's) are usually located in a **single room** or **small building**.

LAN's are computer networks that are **confined** to **small areas**.

An example of a LAN would be a **school network**. The computers on the network would be confined to a classroom or the school.

LAN's are **private** and can only be accessed by people in the room or the building.

For example:

A school network is only used by students who attend the school.

A typical LAN would consist of **several computers** that are **connected** to each other and can share resources such as **printers** and **scanners**.

Computers and devices on a LAN are connected using **cables**.

Examples:

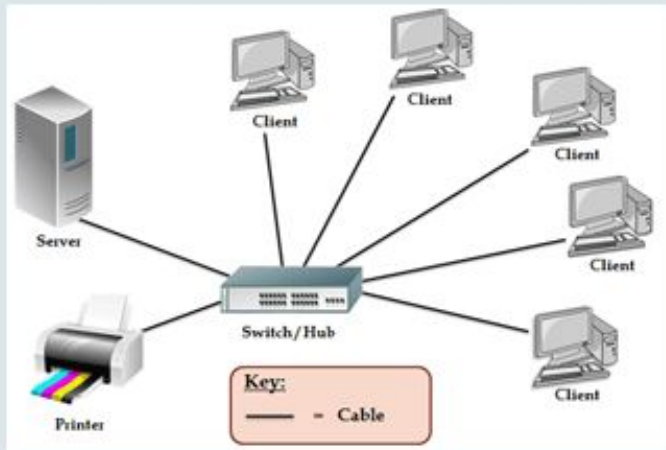

A LAN consists of several computers connected together in order to share resources.
(click to zoom)

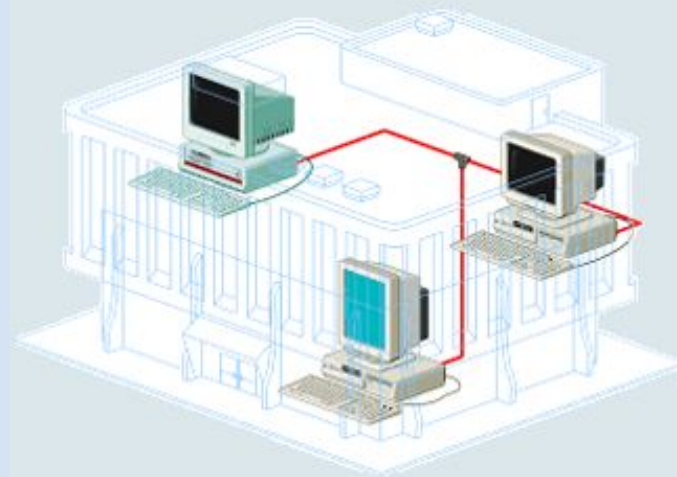

LAN's are confined to one room or a small building.



LAN's allow networked computers to share resources (like printers).



LAN's allow network managers to monitor users (like checking internet usage and passwords).

2 Wireless Local Area Networks (WLAN)

- # WLAN's are similar to LAN's but they **connect computers** together **wirelessly** instead of using cables

This is achieved using **Wi-Fi** technology.

- # **Routers** or **wireless switches** are used to **send** and **receive** data around the network.
- # Client computers or devices send and receive data using **wireless adaptors**.

Most modern **laptops**, **tablets** and **mobile phones** come with **built-in Wi-Fi** adaptors.

- # A typical router can send/receive data to/from computers up to **50 metres** away.

Note:

Most **home networks** are **WLAN's**. They use a router to allow several computers or devices to use the same internet connection.

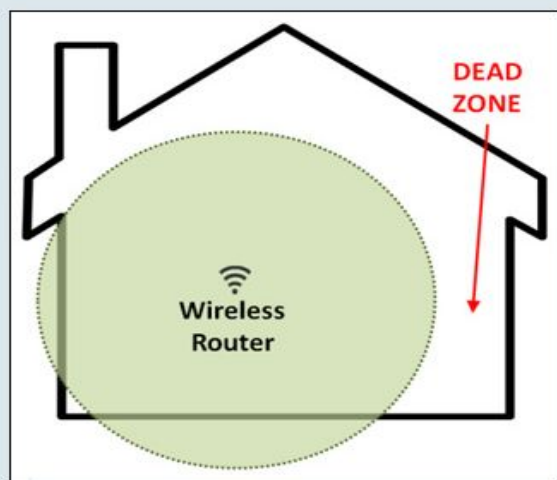

Devices outside of the router's wireless range limit will not be able to connect to the network.



Any wi-fi enabled devices can connect to a wireless network. (click to zoom)

Examples:

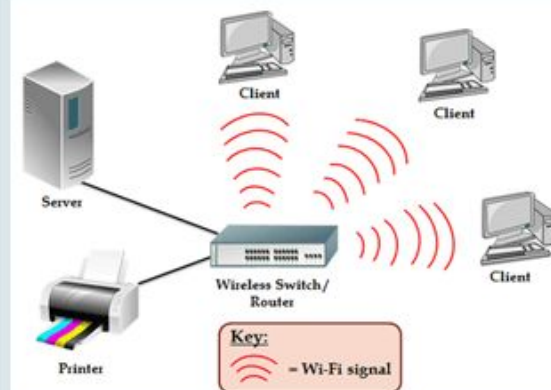

WLAN's use wireless technology instead of cables to connect computers and devices to the network. (click to zoom)



A router can be used to send/receive data wirelessly to/from devices on the network.

Advantages and disadvantages of WLAN's:

Advantages of WLAN's	Disadvantages of WLAN's
<p>Physically safer than a LAN because there are no cables to trip over.</p>	<p>Some areas in the building may not pick up the wireless signal.</p> <p>(This means that computers or devices may not connect to the network from certain locations)</p>
<p>Cheaper to set up than a WLAN because you don't have to buy lots of expensive cables.</p>	<p>Security can be an issue as anyone with a wireless enabled device can try to access the network.</p> <p>(It's very important the network is secured with an encrypted password)</p>
<p>Easier to add more computers to the network.</p> <p>(All they need is a wireless adaptor and they can then communicate with other computers on the network)</p>	<p>Wireless signals can be unreliable as they sometimes suffer from interference from other electronic equipment.</p> <p>(Cables used on LAN's are far more reliable)</p>
<p>Devices such as printers and scanners can be connected to the network easily.</p> <p>(Some printers/scanners have built-in wireless adaptors)</p>	<p>Data transfer around a wireless network is much slower compared to a LAN.</p>
<p>Computers and devices can be used anywhere in the building.</p> <p>(As long as they are in range of the network's router)</p>	<p>WLAN's can be useless for use in a large building as the signal range is limited.</p> <p>(Computers can typically communicate with the router up to about 50 metres)</p>

3 Wide Area Networks (WAN)

- # Wide area networks are made up of **computers** and **devices** that are connected over a **large geographical area**.

The **internet** is the world's **largest WAN**.

The internet is just **millions of computers** all over the world that have been connected together so they can **share data**.

- # WAN's are created by **connecting** lots of **LAN's** and individual **computers** together.

Every time you switch on your **Wi-Fi connection** or access **mobile data (on your phone)**, you are connecting your device or computer to a WAN.

- # Computers and devices can connect to a WAN using **telephone lines**, **fibre-optic cables** and **satellite signals**.

- # In order to connect your computer to a WAN you also need a **router** or a **modem**.

Routers and modems allow your computer to **send/receive data to/from** other computers on the WAN.

Examples:



WAN's are lots of networks and computers connected together over a large area. (click to zoom)



Computers and devices can connect to a WAN using routers, cables or even satellite signals.

Advantages and disadvantages of WAN's:

Advantages of WAN's	Disadvantages of WAN's
<p>Computers can be connected over wide areas.</p> <p>(Across cities or even continents)</p>	<p>Security can be an issue as anyone with access to the internet can potentially access any of the computers on the network.</p> <p>(Computers on the network need to be secured with a firewall and important files should be encrypted)</p>
<p>Files and data can be shared over a large area.</p>	<p>It's very easy to accidentally download viruses from a WAN onto your computer.</p> <p>(You need to make sure that your computer is protected with up-to-date anti-virus)</p>
<p>People can use their computers/devices to communicate very quickly, over large areas.</p> <p>(Sending emails, discussion forums, video conferencing etc.)</p>	<p>Data is transferred across a WAN at a much slower rate than it is across a LAN.</p> <p>(Download speeds are limited)</p>
<p>E-Commerce (shopping) websites can be set up and accessed by people from all over the world.</p> <p>(This allows people with disabilities to purchase items online and have them delivered to their door)</p>	<p>Monitoring a WAN can be difficult because they have so many computers connected to them.</p> <p>(This means that inappropriate content may be uploaded)</p>
<p>Computers and devices can be used anywhere in the building.</p> <p>(As long as they are in range of the network's router)</p>	



The internet is the world's largest WAN. It is millions of computers and devices linked together all over the world.



Transferring files across a WAN can be slow.



Computers connected to a WAN are more at risk of security risks like viruses and hackers.

4 Bluetooth (WPAN)

- # Bluetooth is also known as a **Wireless Personal Area Network (WPAN)**.
- # Bluetooth devices can connect to each other from between **1 and 100 metres** away.

The connection is made **without** using **wires** or **cables**.

Bluetooth uses **radio waves** to transmit data.

- # Once two devices are connected with bluetooth, you can **transfer files** and **data** between them up to the maximum range of **100 metres**.

Note:

Devices which can make use of bluetooth include:



Mobile phones



Tablets



Wireless Speakers

Examples:



Bluetooth networks are known as 'personal networks' because devices have to be close together in order to connect. (click to zoom)



Bluetooth devices connect together wirelessly up to a range of 10 metres.

Advantages and disadvantages of Bluetooth:

Advantages of Bluetooth	Disadvantages of Bluetooth
<p>Very easy to connect bluetooth devices together.</p> <p>(you just switch on your bluetooth and wait for the devices to pair)</p>	<p>Limited signal range.</p> <p>(With the normal signal range limit of only 10 metres, the two devices need to be close-by to connect)</p>
<p>Bluetooth signals are not easily to disrupt.</p> <p>(They aren't easily affected by other electrical devices like Wi-Fi can be)</p>	<p>Slow data transfer. Bluetooth is not suitable for transferring large files.</p> <p>(Bluetooth cannot transfer data between devices as fast as Wi-Fi.)</p>
<p>Works wirelessly so there are no messy cables needed to connect devices.</p>	<p>Very unsecure connections and easy for hackers to break into.</p>
<p>Bluetooth uses very little power.</p> <p>(This means that using bluetooth won't drain your devices battery quickly)</p>	<p>(Bluetooth is not as secure as Wi-Fi and makes it unsuitable for transferring sensitive or private data)</p>



Bluetooth transfer speeds are very slow.



Bluetooth connections are not very secure and easy for hackers to break into.

Network Devices

In order to build a network, you need to use different types of **hardware**.

In this section we discuss these types of hardware and describe exactly what they are used for.

Key Concepts of this section:

- # Understand that there are **seven** networking devices that can be used to construct a computer network.
- # Know the **features** of each network device.
- # Be able to **describe** the **role** that each networking device plays in the construction of a network.

Types of networking devices

There are **seven** main devices that are used to build a network. These are:

- [Router](#)
- [Network Interface Cards \(NIC\)](#)
- [Network Cable](#)
- [Hubs](#)
- [Switches](#)
- [Bridges](#)
- [Modems](#).

We will discuss each type of device and look at what they are used for below:



Key Words:

Router, Network cards, Cable, Hub, Bridge, Switch, Modem.

Examples:

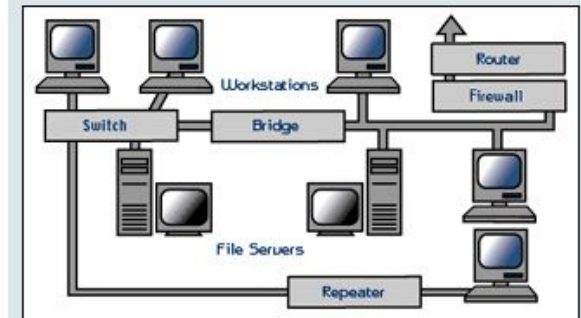

Networks consist of various hardware.

1 Router

What are routers used for?

- # Routers enable **data** to be **sent** (routed) between **different** types of **networks**.

For example:

A router could be used to connect a **LAN** (local area network) to a **WAN** (wide area network).

- # Routers are most commonly used to **connect computers** and **devices** to the **internet** (WAN).
- # Computers can connect to a router either through cables or wirelessly.

What exactly do routers do?

- # At this point, you can see that routers can **connect** different types of **networks** together and **send data** between them.

They can do this because they are **intelligent** devices and can perform the following functions:

- They can **read data** and decide **where** to send it
- They can decide on the **fastest route** in which to send the data
- They can make the **format** of the data **suitable** for the network where it is being sent.

This is where the name '**router**' comes from. They can **direct** data between networks using the **best/fastest route** possible.

Examples:

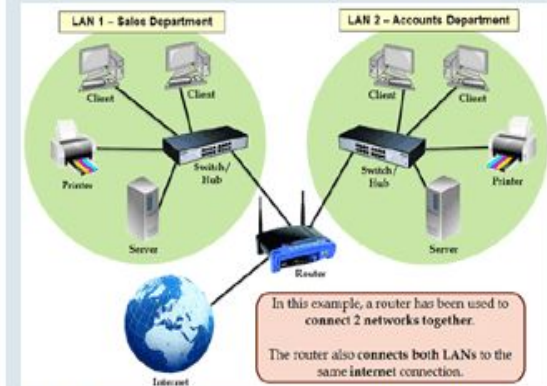

Routers are used to connect networks together or to connect networks to the internet.
(click to zoom)



Routers allow computers on a LAN to share the same internet connection.

1 Router

IP Addresses

- # All computers and devices connected to the internet are assigned a **unique number** called an **Internet Protocol Address** (IP address).

A computer or device's IP address determines its **exact location**.

- # The IP address of the device would depend on **where in the world** it connected to the internet from.

The list below shows some examples of different IP addresses in various countries:

- **Bermuda** - 64.147.80.0
- **United Kingdom** - 80.247.16.0
- **United States** - 168.99.0.0

- # Computers on the **same network** would share the **same first few numbers** of the IP address.

This is used to **locate** the **network**.

- # Different **devices** on the same network are uniquely identified by the **last few numbers** of the IP address.

On my school's network, IP address for individual devices could be assigned like this:

- **Desktop PC** - 64.128.80.101
- **Printer** - 64.128.80.147

This is used to **locate** individual **devices** on the network.

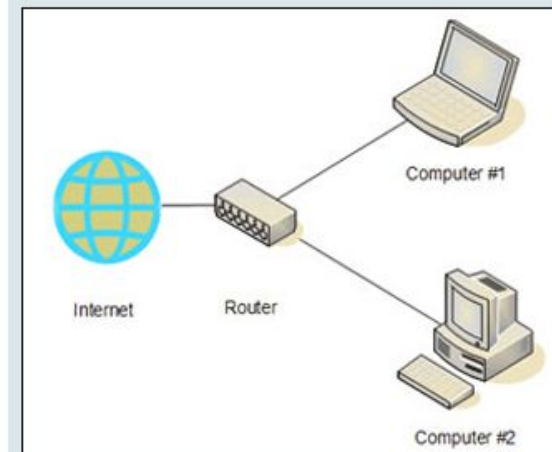

Multiple devices connecting to the internet through the same internet connection.

```
[root@fedora10 ~]# netstat -nr
Kernel IP routing table
Destination      Gateway         Genmask        Flags
60.49.199.72    0.0.0.0        255.255.255.248 U
172.16.163.0    172.16.160.1  255.255.255.0 UG
172.16.162.0    172.16.160.1  255.255.255.0 UG
172.16.161.0    172.16.160.1  255.255.255.0 UG
172.16.160.0    0.0.0.0        255.255.255.0 U
172.16.167.0    172.16.160.1  255.255.255.0 UG
172.16.166.0    172.16.160.1  255.255.255.0 UG
172.16.165.0    172.16.160.1  255.255.255.0 UG
172.16.164.0    172.16.160.1  255.255.255.0 UG
172.16.170.0    172.16.160.1  255.255.255.0 UG
172.16.169.0    172.16.160.1  255.255.255.0 UG
172.16.168.0    172.16.160.1  255.255.255.0 UG
169.254.0.0     0.0.0.0        255.255.0.0   U
169.254.0.0     0.0.0.0        255.255.0.0   U
0.0.0.0         60.49.199.73  0.0.0.0        UG
[root@fedora10 ~]#
```

Routers store IP addresses in a routing table which they use to work out the best route in which to send data to its destination network.

1 Router

How does a router store IP addresses?

- # Routers store IP addresses in something called a **routing table**.
- # The routing table **lists** all of the **different routes** to other networks.
- # The router will use the routing table to determine the **best route** to use when sending data to another network.

How does a router send data between computers?

- # Routers send '**packets**' of data between computers on different networks.
- # Each data packet contains the **IP address** of the computer/network that the data is being sent to.
- # The router will use the IP address to work out the **best route** in which to send the data to it's destination.

Remember:

The router will use the **first few numbers** of the IP address to determine the **location** of the **network** and the **last numbers** to determine which **device** on the network has requested the data.

- # The data will be received by **routers** on other networks which will read the IP address and **re-route** the data until it ends up at the **exact device** it was intended for.

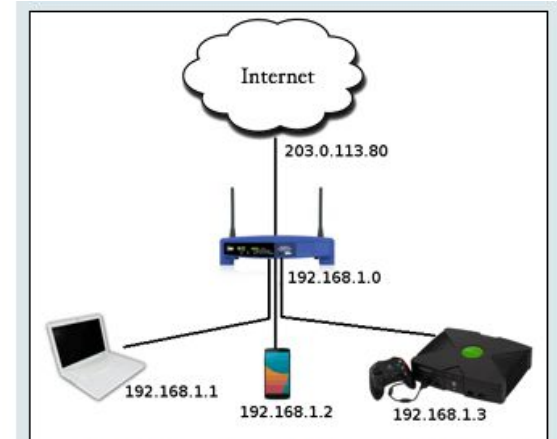

Routers use IP addresses to work out where to send packets of data.

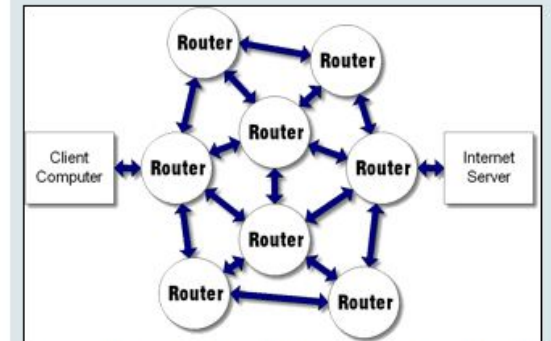

Packets of data sent over the internet can pass through many other network's routers until it reaches it's destination.

2 Network Interface Card (NIC)

What are network interface cards used for?

- # Network Interface Cards are used to **connect** individual **computers/devices** to a **network**.

Modern computers usually come with network interface cards already **built-in**.

- # Network interface cards have **ports** which allow **network cables** to be **plugged in** and connect the computer to the network.

Note:

There are **two** types of network interface card:

- Wired network interface card (Where cables are used to connect computers)
- Wireless network interface card (Where computers are connected using Wi-Fi)

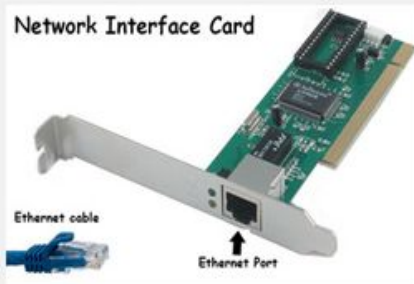

A wired network interface card connects computers to a network using cables.



A wireless network interface card connects computers to a network using Wi-Fi signals.

Examples:

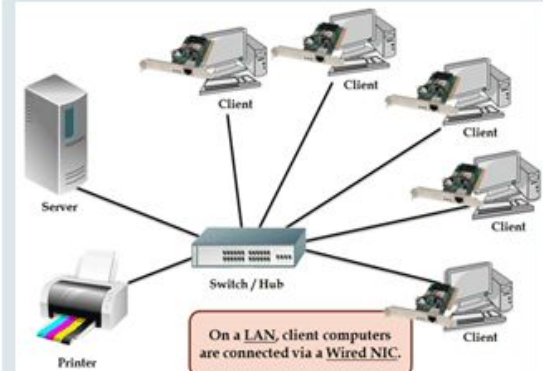

A wired NIC uses cables to connect computers/devices to a network. (click to zoom)

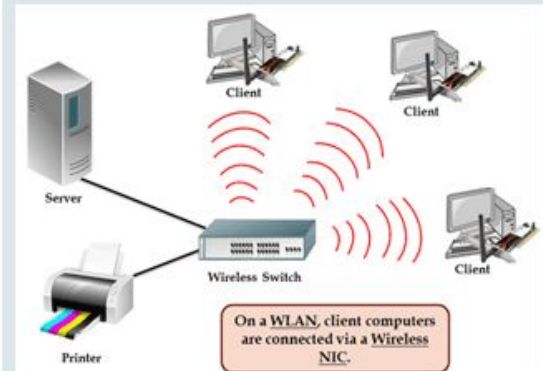

A wireless NIC uses Wi-Fi to connect computers/devices to a network. (click to zoom)

3 Network cable

What are network cables used for?

- # Network cables are **plugged** into a computers **wired network interface card** and connects it to the network.

Data is sent around the network via the network cable.

- # Cable holds **advantages** over wireless connections for two reasons:
 - Cables can transfer data **faster** than wireless
 - Data transferred over cables is **more secure** than over wireless (**Hackers can't intercept data easily**).

Note:

Network cables are made up of different wires:

- Some wires are used to **send** data **to** the computer
- Some wires are used to **receive** data **from** the computer.



A network cable.



Network cables have connectors on each end that plug into network interface cards.



The wires inside a network cable perform different functions.

Examples:



Network cables plug into the ports on network interface cards.



Network cable is used to connect computers and devices to a network.

4 Hubs

What are hubs used for?

- # Hubs allow computers and devices to plug into their ports in order to **connect** to each other and **share files, data** and **resources**.
- # Hubs are '**non-intelligent**' devices and they **don't manage** any of the data that flows through them.

When data gets sent to the hub, there is **no attempt** to **locate** the computer/device that the data is **meant for**.

The hub simply sends the data onto **every** computer/device on the network.

This means that every device on the network will **receive** the **same data** whether they requested it or not.

- # This lack of data management makes networks that are connected by hubs **very slow** because there is a lot of **unnecessary data** flowing around.

Note:

Hubs are **old technology** and have been replaced by switches which manage data more effectively and operate much faster (**more on switches later**).

See the image to the right for a picture example of how hubs work



Examples:



Hubs allow devices to connect to each other by plugging network cables into their ports.

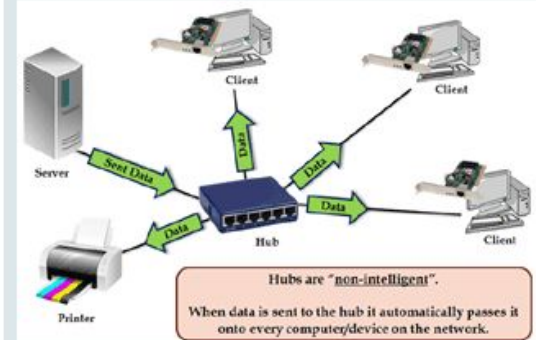

Hubs are 'non-intelligent' devices and do not manage data flowing around the network. (click to zoom)

5 Switch

What are switches used for?

- # Switches are **similar to hubs** in that they connect computers/devices to form a LAN.

However, switches are '**intelligent**' devices and transmit data around the network **more efficiently**.

How do switches manage network data?

- # How switches manage data is summarised below:

- Each network device has a **Media Access Control (MAC) address** which uniquely identifies it.
- Data sent to the switch contains the MAC address of the **sending device** and the MAC address of the **receiving device**.
- The switch will **check** these addresses and only send the data to the **relevant device** rather than to all devices.

See the image to the right for a picture example of how switches work



Because switches send data directly to the correct device, the amount of unnecessary data traveling around the network is **reduced** and the whole network **works faster**.

Examples:



A network switch works in a similar way to a hub in that it allows network devices to connect to each other.

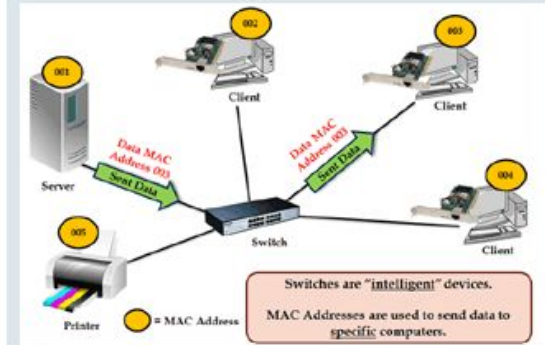

Switches are 'intelligent' devices and effectively manage network data. (click to zoom)

6 Bridge

What are bridges used for?

- # Bridges are used to **connect** (bridge) LAN's together.
- # Bridges can **connect** different types of **networks** so that they act as **one single LAN** and thus can communicate with each other.

For example:

You have **two networks**. One network connects the computers/devices with **cables** and the other connects the computers/devices using **wireless**.

The cabled network **cannot communicate** with the wireless network and vice versa.

By using a bridge, all of the computers/devices can communicate with each other as **one single LAN**.

See the image to the right for a picture example of how bridges work



Examples:



Bridges are used to connect (bridge) multiple LAN's together.

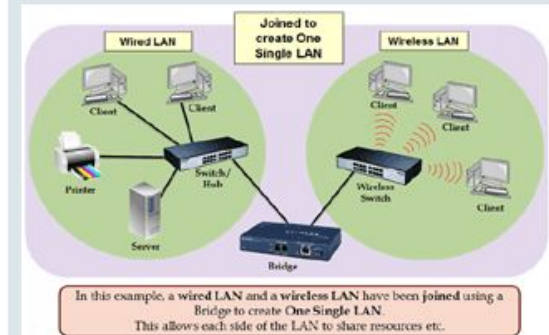

A bridge can allow two different LAN's to communicate with each other. (click to zoom)

7 Modems

What are modems used for?

- # Modem stands for '**Modulator Demodulator**'.
- # Modems were used to connect computers to the internet before we had the use of broadband connections.

NOTE:

Some modern modems have routers **built-in**. This allows **multiple devices** to connect to the **same** internet connection.

If your modem does not have a built-in router, you will only be able to connect **ONE** device to the internet at a time. You can, alternatively, buy a **separate router** and connect it to your modem.

How do modems work?

- # Most internet connections are made over **telephone lines**. Telephone lines are designed to carry **sound and voices**, which are **analogue** signals.



Examples:

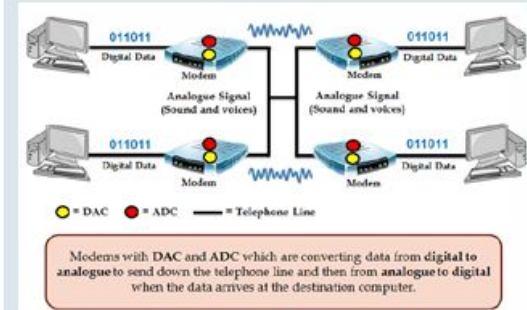

This diagram shows how modems are used to convert data between analogue and digital in order to send down a telephone line. (click to zoom)



An old modem which allowed people to connect to the internet.

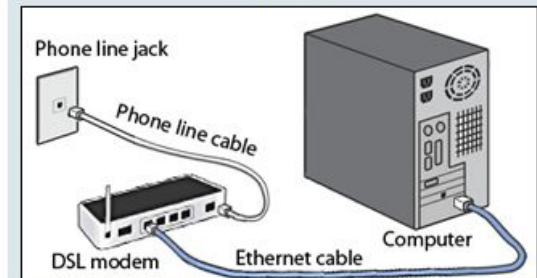

A modem sits between the computer and the telephone system and converts data between digital and analogue.

7 Modems

How do modems work?

- # The problem is that computer data is **digital** and it is **not possible** to send digital data over an analogue telephone line.

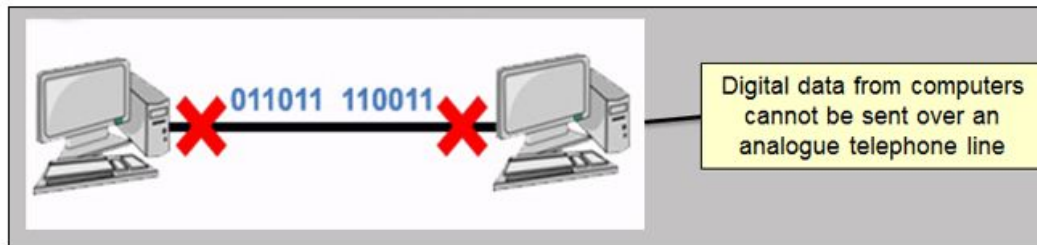

- # This is where the modem comes in.

The modem can **convert** the **digital** computer data into an **analogue** signal/noise (**modulate**) so it can be sent over the analogue telephone line.

- # Modems can also reverse this process and convert the **analogue** signals from the telephone line into **digital** data (**demodulate**) so the computer can use it.
- # Modems contain both a **Digital to Analogue Converter** (DAC) and a **Analogue to Digital Converter** (ADC).

Note:

DAC
(modulator)



Converts the **digital data** from the computer into an **analogue signal** which can then be sent down the telephone line.

(Literally converts digital data into noises which is what the telephone line is designed to carry - [demo](#))

ADC
(Demodulator)



Converts the **analogue signal** in the telephone line into **digital data** so that the computer can process and use the data.

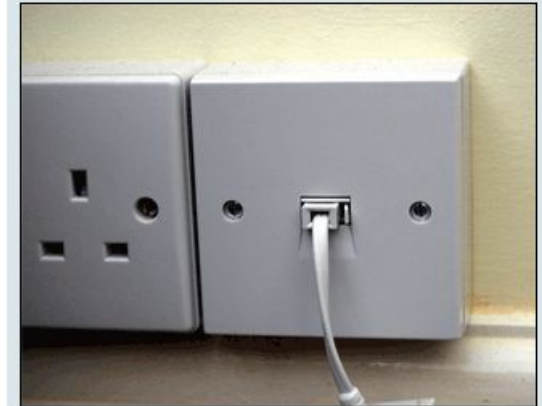

Modems convert digital signals into analogue (sound) so they can be sent down a telephone line to their destination.

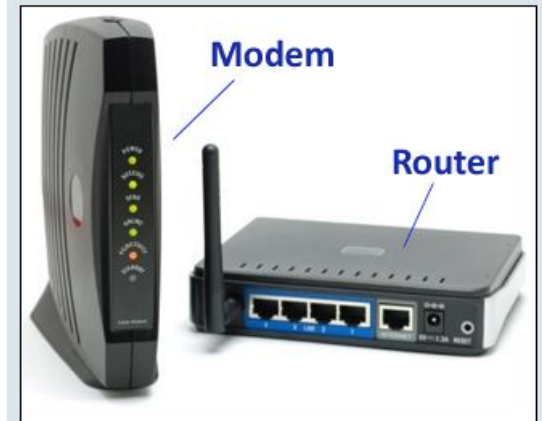

Some modems have routers built-in and some don't. If you want to connect multiple devices to the same internet connection you will need both.

The difference between the Internet and the Intranet

The **internet** and the **intranet** are two very different things.

In this section we discuss the **differences** between the two including their respective **purposes** and **uses**.

Key Concepts of this section:

- # Understand the **difference** between the **internet** and an **intranet**.
- # Know the **uses** of the **internet** and an **intranet**.
- # Be able to **compare** the **internet** to an **intranet** in terms of what they are **used** for.

Internet and intranet

There are **two** main types of **network environments**. These are listed below:

- [Internet](#)
- [Intranet](#).

Each of these have their own **purposes** and **uses** and we will discuss both of these in detail below.

We will also [compare](#) the two of them in terms of how their **purposes** differ from each other.



Key Words:

Internet, Intranet.

Examples:

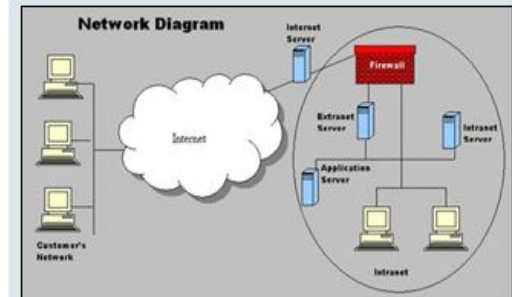

The internet and an intranet.

What is the internet?

- # The internet is a huge **collection of computers and networks** that have been **joined together**.

Remember:

The internet is the **world's largest WAN** (wide area network) and it is getting bigger all the time as more and more people connect their devices to it.

- # When you connect your device/computer to the internet, you can potentially **access** and **share** data from other computers that are connected.
- # The internet started off as a **military project** in the 1960's called '**ARPANet**'.

ARPANet was initially designed to connect **4 powerful computers** so that researchers had access to them all.

Over the years more and more computers connected to ARPANet until it eventually became the internet that we know today.

Note:

As of February 2016, there are **3.3 billion** devices and computers connected to the internet. Click [here](#) for up-to-date internet usage stats.

What is the internet used for?

- # Because there are so many computers connected to the internet, it is literally the largest source of **shared information** in the world.

The list below highlights this and some other uses of the internet:

- Browsing **web pages** using the World Wide Web (**www**)
- Sending and receiving **emails**
- **Sharing** files and information
- **Video Conferencing** (**face to face discussion using a web cam**)
- **Voice calls** (**like Skype**)
- Streaming **music** and **video**
- Online **banking**
- **E-Commerce** (**buying/selling goods online**)
- **Advertising**
- **Blogging**
- **Social media**
- Playing multi-player **online games**.

How do you connect to the internet?

To access the internet you need several things:

- A **computer** or **device** (such as a tablet or a mobile phone)
- A **router** or a modem (to send digital data over the telephone network)
- An **ISP** (internet service provider).

Note:

Mobile phones or tablets don't necessarily need a router as you could access the internet using a paid **data plan**.

Internet Service Providers (ISP) are companies that provide users with **access** to the internet, usually for a monthly or annual fee.

Once you have paid your fee to the ISP, you would be given a **username** and **password** which you can use to **connect** to the internet.

Here in Bermuda, internet service providers include Logic and CableVision.

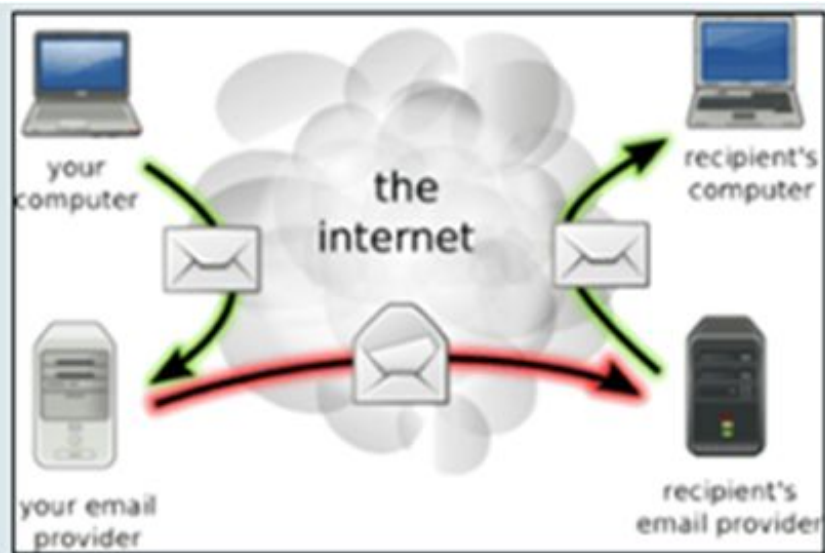

One use of the internet is to send emails from one location to another.

Dynamic DNS

Use a Dynamic DNS Service

Service Provider:

Host Name:

User Name:

Password:

ISP's provide you with a login and password so you can connect to the internet.

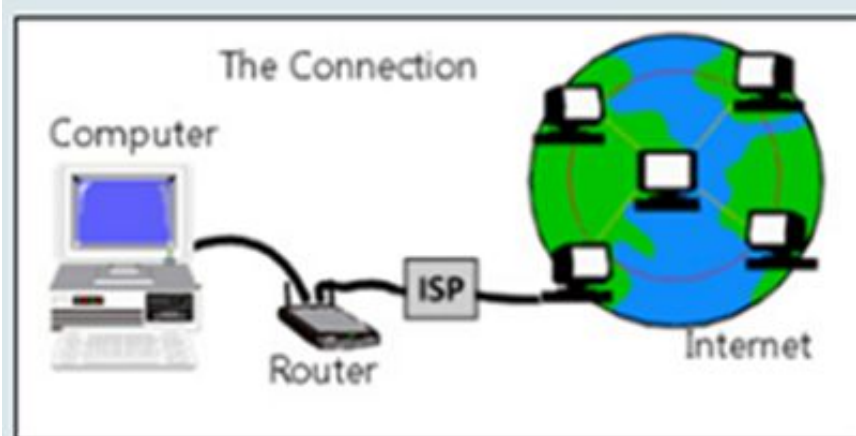

To connect to the internet you need a computer, a router/modem and an internet service provider (ISP).

2 Intranets

What is an intranet?

- # Intranets are like a **private internet**. They function in a similar way to the internet but are only accessible by users of the intranet (outsiders cannot connect).

Intranets exist only within the **building** or the **company** and users need a **login id** and **password** before they can join.

What are intranets used for?

- # Intranets offer **similar features** to the internet such as:
 - Viewing **web pages**
 - Sending **emails**
 - **Sharing** files and information
 - etc.
- # **Schools** often make use of intranets to provide information to students.

This information could include:

- Learning **resources**
- Course information
- **Homework** schedules
- etc.

Only students in the school that own the intranet would be able to access this information. Everyone else is **locked out**.

How do you connect to an intranet?

- # Anyone with the right to use an intranet would be given a **login id** and **password**.

Anyone without the correct login details would be **unable** to connect.

You would also normally have to be **physically within** the **building** where the intranet exists in order to use it (*inside the school or business premises for example*).

- # Login id's can also be used to **restrict** users from accessing certain parts of the intranet.

For example:

Students could be given access to **course information** and **homework schedules** only and **teachers** could be given access to **everything** on the intranet.

Examples:

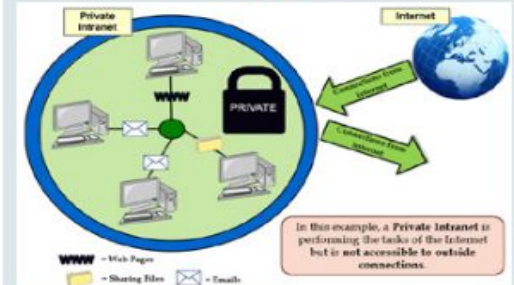

Intranets are like private internets and are not accessible from outside connections. (click to zoom)



An intranet is private and only exists within the premises of an organisation such as a school.



An intranet is private and only exists within the premises of an organisation such as a school.



An example of a school intranet. It contains information that is relevant to the people using it. (click to zoom)

2 Intranets

Comparing the internet and intranet

The table below **summarises** the **differences** between the internet and an intranet in terms of their **purpose** and **how** they are used:

Internet	Intranet
The term ' Internet ' comes from the phrase International Network .	The term ' Intranet ' comes from the phrase Internal Restricted Access Network .
The internet is used to share data globally .	Intranets are used to share data locally and privately .
The internet is used to provide information that is relevant to a wide range of people.	Intranets are used to provide information which is relevant to a single company or organisation .
The internet can be accessed from anywhere as long as you have an internet connection.	Intranets can only be accessed from within the company or organisation that owns it.

Examples:



The internet allows users to share information globally.



Intranets allow users to share data with a room or building.

Using different computers to access the internet

Different **computers** and **devices** can be used to access the **internet**.

In this section we discuss the **advantages** and **disadvantages** of accessing the internet using **desktops**, **laptops**, **tablets** and **smartphones**.

Key Concepts of this section:

- # Understand that different **devices** can be used to access the internet.
- # Be able to **describe** the **advantages** and **disadvantages** of using each device to access the internet.

Accessing the internet using different devices

There are **four** main devices that we can use to access the internet. These are:

- [Desktop PC](#)
- [Laptop](#)
- [Tablets](#)
- [Smartphone](#).

We will discuss the **advantages** and **disadvantages** of using each device for gaining internet access:



Key Words:

Desktop PC , Laptop, Tablet, Smartphone, Internet.

Examples:



The internet can be accessed by several different devices.

1 Desktop PC

Advantages/disadvantages of using desktops to connect to the internet

These are summarised in the table below:

Advantages of Desktops	Disadvantages of Desktops
<p>Most websites are designed to be viewed using a desktop.</p> <p>This means web pages will be displayed fully.</p> <p>(Web pages viewed through smartphones often have reduced content due to small screen size)</p>	<p>Desktop PC's are not portable so you can only access the internet from the room where the computer is setup.</p>
<p>Desktops have larger keyboards than all other devices which makes it easier to type keywords into search engines.</p>	
<p>Desktop screens (monitors) are larger than other devices and give a better web page viewing experience.</p> <p>(Everything appears larger which makes navigating web pages easier)</p>	
<p>Desktops usually use wired internet connections which is more stable and reliable than Wi-Fi.</p>	

Examples:



Desktop keyboards are big with large keys. This makes them easy to use.



Desktop screens are larger than other devices and offers superior web page viewing.



Most desktop PC's have a wired internet connection which is more stable than Wi-Fi.

2 Laptop

Advantages/disadvantages of using laptops to connect to the internet

These are summarised in the table below:

Advantages of Laptops	Disadvantages of Laptops
More portable than desktops so you can access the internet from more locations.	Less portable than tablets and smartphones.
Larger screen than tablets and smartphones which makes reading web page content easier.	Screens not as large as desktop PC's and web page content may not appear as clearly.
Keyboards on laptops are larger than those of tablets/smartphones and are easier to enter terms into search engines.	Processors (cpu's) in laptops are not quite as powerful as those in desktops. <i>(Web pages may not load as smoothly)</i>
Touchpads on a laptop mean that you can still navigate web pages even if you aren't working on a flat surface . <i>(A desktop's mouse needs a flat surface to operate)</i>	

Examples:



Laptops are more portable than desktops and can access the internet from more locations.



Laptop touchpads can be used even when there is no flat surface.



Laptops have larger screens than tablets and smartphones.

3 Tablets

Advantages/disadvantages of using tablets to connect to the internet

These are summarised in the table below:

Advantages of Tablets	Disadvantages of Tablets
<p>Smaller and lighter than desktops and laptops. This makes them more portable and much easier to carry.</p> <p>(Internet can be accessed from any location where it is available)</p>	<p>Larger and less portable than smartphones.</p> <p>Use Wi-Fi to connect to the internet which is less reliable than a desktops wired connection.</p>
<p>Larger screen than smartphones which makes reading web page content easier.</p>	<p>Screens are smaller than desktop PC's or laptops and web page content may not display as well.</p> <p>(Modern websites can be designed to change the layout of the page when viewed on smaller screens)</p>
<p>On-screen keyboards are larger than the smartphone version and easier to use.</p>	<p>On-screen keyboards are not as easy to use as the physical keyboards found on desktops and laptops.</p> <p>(Easy to miss-key words and make mistakes)</p>

Examples:



Tablets are smaller than laptops and so are more portable.



Tablets have larger screens than smartphones.



Tablet on-screen keyboards are larger and easier to use than smartphone keyboards.

4 Smartphone

Advantages/disadvantages of using smartphones to connect to the internet

These are summarised in the table below:

Advantages of Smartphones	Disadvantages of Smartphones
<p>The smallest and most portable of all devices that can access the internet.</p> <p>(Internet can be accessed from anywhere where there is a Wi-Fi hotspot or mobile data signal)</p>	<p>Websites displayed on a smartphone are often not the full version of the site.</p> <p>(Web pages viewed on desktops/laptops full sized screen show all content)</p>
<p>People are more likely to have a mobile phone with them wherever they go.</p> <p>(This means they can have internet access at all times)</p>	<p>Small screen sizes can make viewing web page content difficult.</p>
<p>Much easier to access the internet whilst on the move than laptops or tablets.</p>	<p>Very small keyboards can make it difficult to type in emails or search engine keywords.</p> <p>Smartphones allow children to access the internet from anywhere. This can leave them vulnerable to online predators.</p> <p>(Parents may find it difficult to check what their children are up to online)</p>

Examples:



Smartphones are the most portable of all devices and can access internet anywhere where it is available.



Websites viewed on smartphones may look different to those viewed on tablets or laptops.



On-screen keyboards on smartphones are small and difficult to use.

Comparing Bluetooth and Wi-Fi

Wi-Fi and Bluetooth are the two main ways that computers can **communicate** with each other **wirelessly**.

In this section we will discuss how each of these work as well as comparing them with each other.

Key Concepts of this section:

- # Understand that both Wi-Fi and Bluetooth allow for the creation of **wireless** networks.
- # Know how computers can use Wi-Fi and Bluetooth to **connect** to a network.
- # Be able to **contrast** and **compare** Wi-Fi and Bluetooth.

Bluetooth and Wi-Fi

The two main technologies that computers can use to **communicate wirelessly** are listed below:

- [Wi-Fi](#)
- [Bluetooth](#).

Remember:

Wirelessly means to connect computers or devices together **without** using **wires** or **cables**.

We will look at how computers connect to networks using both bluetooth and Wi-Fi and compare the two.



Key Words:

Wi-Fi, Bluetooth.

Examples:



Wi-Fi and Bluetooth are the two main ways to connect to networks wirelessly.

1 Wi-Fi

What is Wi-Fi?

- # Wi-Fi allows computers/devices to **connect** to each other **wirelessly**, without using cables or wires.

The computers communicate with each other by using **signals** that are broadcast using **radio waves**.

- # In order to use Wi-Fi, you need to have access to the **internet** and a **router**.

Areas where computers/devices can access the internet using Wi-Fi are known as **hotspots**.

- # **Routers** are commonly used to provide a **hotspot** for other computers to connect to the internet.

The router will be connected to the internet through an **ISP (Internet Service Provider)** and will transmit a wireless signal that wireless devices **nearby** can tap into.

This allows **multiple** devices to share the same internet connection.

- # Routers can only broadcast the wireless signal over a **limited** distance. If a device is out of range, it will not be able to tap into the signal.

The range limit of a typical router is between **50m** and **100m**.

How do computers connect to a Wi-Fi network?

- # In order to connect to a network using Wi-Fi you would need:
 - A **computer** or **device**
 - A **wireless network interface card** (Wi-Fi is built-in with many modern devices)
 - Access to a **wireless hotspot** (usually through a router).

Examples:



Wi-Fi allows computers to communicate using radio waves.



Wi-Fi hotspots allow devices to share the same internet connection.

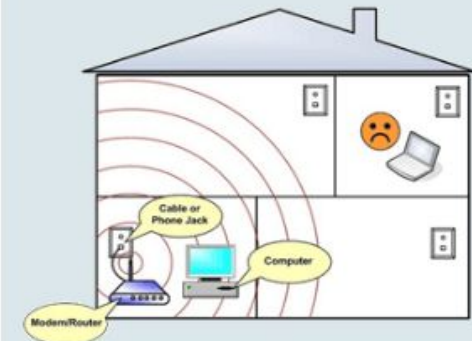

2 Bluetooth

What is Bluetooth?

- # Bluetooth is also known as a **Wireless Personal Area Network (WPAN)**.
- # Bluetooth is a form of **wireless** technology that uses **radio waves** to transfer data over distances of between **1 and 100 metres**.

Devices that have this technology contain one of **three classes** of Bluetooth:

- **Class 1** - Most powerful - can transmit data up to **100m**
- **Class 2** - Most common - can transmit data up to **10m**
- **Class 3** - Least powerful - can transmit data up to **1m**.

How do computers connect to a Bluetooth network?

- # In order to connect to a network using Bluetooth you would:
 - Need a **computer** or **device** with **bluetooth** technology
 - Turn bluetooth **on** using your device's settings
 - Let your device **scan** for other bluetooth devices in **range**
 - Send a request to the other bluetooth to **'pair'** (join) with it
 - Once paired, you could **share data** between the devices (**while in range**).

Uses of Bluetooth:

- # Bluetooth has a wide-range of **uses**. some of these are summarised in the table below:

Use input/output devices wirelessly → Devices like **keyboards, mice, printers** and **speakers** can be connected to a computer system without the need for messy wires.
(This can help prevent physical hazards like tripping and helps keep your workspace neat)

Sharing mobile phone data between devices → Data like **contact numbers** can easily be transferred from one phone to another.
(This is perfect if you get a new mobile phone and don't want to re-enter your contact information)

Connecting to hands-free headsets → **Wireless headsets** allow people to talk into their mobile phones whilst driving.
(This frees up their hands and allows them to concentrate on driving - much safer)

Examples:



Bluetooth networks are known as 'personal networks' because devices have to be close together in order to connect. (click to zoom)



When Bluetooth is switched on, your device will search for other Bluetooth devices to connect to.



Bluetooth hand-free headsets make driving much safer

Comparing Wi-Fi and Bluetooth

The table below compares and contrasts the **similarities** and **differences** between Wi-Fi and Bluetooth:

Comparison	Wi-Fi	Bluetooth
Data speeds	Data transfer speeds of up to 250Mbps . (Equivalent to downloading about six mp3 music tracks a second)	Data transfer speeds of up to 25Mbps . (Equivalent to downloading less than one mp3 music track a second)
Winner = Wi-Fi		
Signal range	Range limit of up to 100m .	Most Bluetooth devices have a range limit of up to 10m .
Winner = Wi-Fi		
Security	256-bit encryption used to protect transmitted data.	128-bit encryption used to protect transmitted data.
Winner = Wi-Fi		
Power usage	Uses more power.	Uses less power.
Winner = Bluetooth		
Signal reliability	Wi-Fi signal can be interrupted by electrical equipment.	Bluetooth signal is not as prone to interruption.
Winner = Bluetooth		
Max number of connected devices	Up to 255 devices per router.	Up to 7 devices.
Winner = Wi-Fi		

Examples:



Wi-Fi can transfer data much faster than Bluetooth.



Data sent over Wi-Fi is more secure than data sent over Bluetooth.



Bluetooth won't drain your device's battery as quickly as Wi-Fi will.

How to set up and configure a small network

To set up a **small network** (of say 5 computers) that can **share** an **internet connection**, you would need the following:

- [Correct hardware](#)
- [Correct software](#)
- [An internet service provider \(ISP\)](#).

NOTE:

If you were trying to set up a **larger** network, you would need to use more **sophisticated** hardware and software than the types we are going to look at.

We will look at all of these and explain where they fit into the network:

What hardware will I need?

The hardware that we will need is listed below:

- **Computers** or **devices** (laptops, desktop PC, tablets etc.)
- Other **network devices** (printers scanners etc.)
- A **router/modem** (so computers on the network can send data to each other)
- **Network interface cards** (wired or wireless)
- Network **cables** (so any devices with wired NEC's can plug into the router)
- **Telephone line/Cable line** (to connect the network to a WAN/internet).

What software will I need?

The software that we will need is listed below:

- A **firewall** (to help protect against hackers)
- **Anti-virus** (to help keep the network virus-free)
- A **web browser** (so computers connected to the network can use the web)
- An **email** account.

Examples:

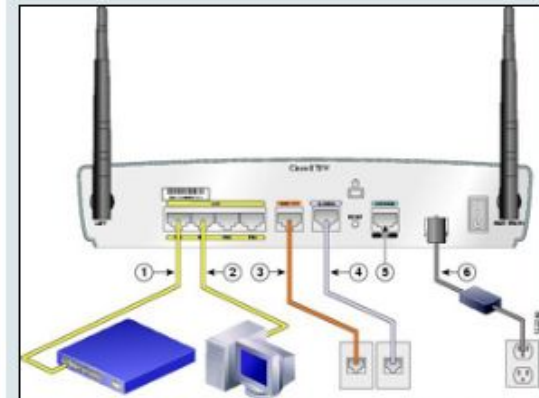

A router will allow you to network all of your devices and share an internet connection.



A network interface card will let you connect any wired devices to the router.



A firewall is software that protects your device from potential threats on the internet.

What is an internet service provider (ISP)?

- # An ISP is a company that gives you **access** to the **internet**.
- # Internet service providers will charge you a **monthly fee** in return for internet access.

The **amount** you **pay** will vary depending **how fast** you want your connection to be.

- # Popular ISP's here in Bermuda include **Logic** and **CableVision**.

How does all of this fit together?

- # Once you have all of the hardware/software and an internet service provider, creating the network is very straightforward.

The table below explains how:

1. Sign up and pay for an account with an **internet service provider**.
(Your ISP will usually supply you with a router/modem)
2. Connect the **router/modem** to one end of the **telephone line** or the **cable line**.
Plug the other end of the line into your **telephone/cable box**.
3. Connect **cabled devices** to the router using your **network cable**.
(This network cable will plug into the network interface card on the device and the ports on the router)
4. Connect **wireless devices** to the router using **Wi-Fi**.
(For each device, you will need to configure their settings and enter the password to access the router. Password is supplied by the ISP)
5. Install and configure a **firewall** and **anti-virus** software on each device that will form the network.
(These will protect your networked devices against hackers and viruses)
6. Configure the **router** with your **internet login details** supplied by the ISP.
7. Use the **web browser** installed on each of your networked devices to access the internet.



Anti-virus software will shield your networked devices against viruses.

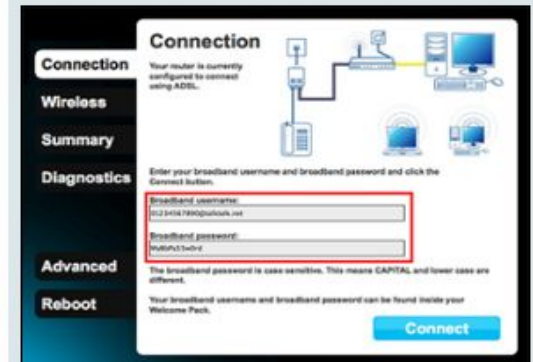

You access the internet by entering your ISP login details into the router.



Access the internet through your preferred web browser.

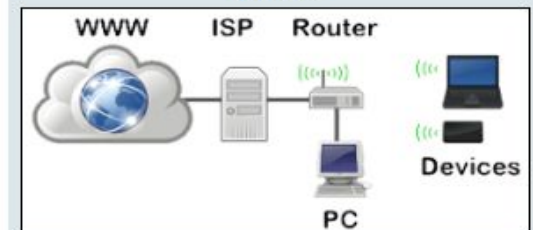

And there you have it.... a small network.