

Ребусы

Раздел: Кулинария



**Выполнила:
Учитель технологии
МАОУ Ямской СОШ
Надежина Елена Васильевна
2012**

Ребусы

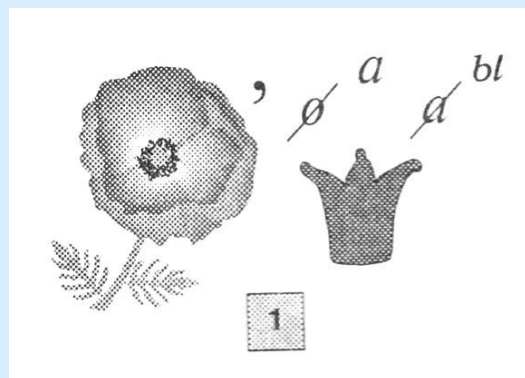

Ребусы

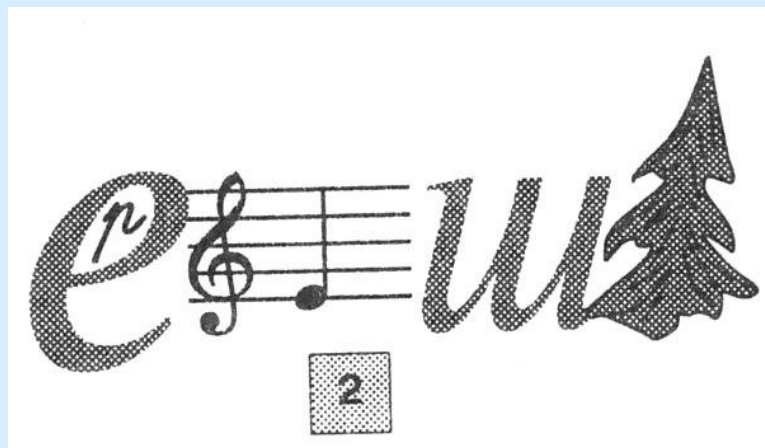

Ребусы

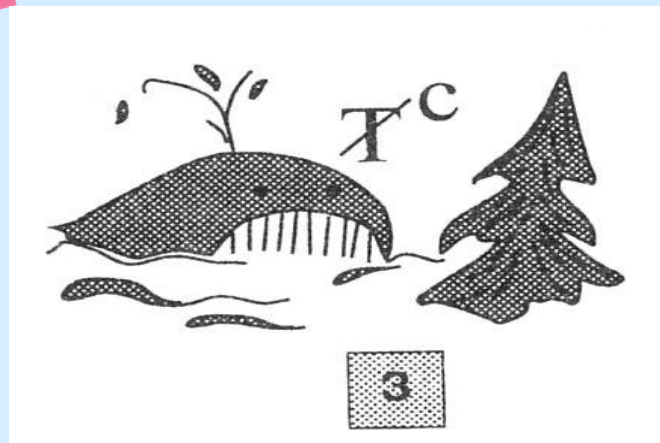

Ребусы

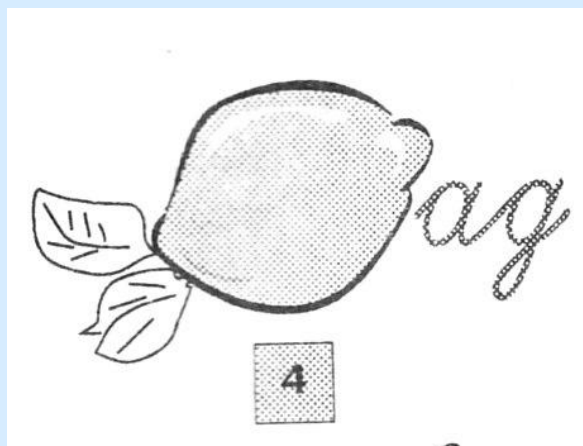

Ребусы

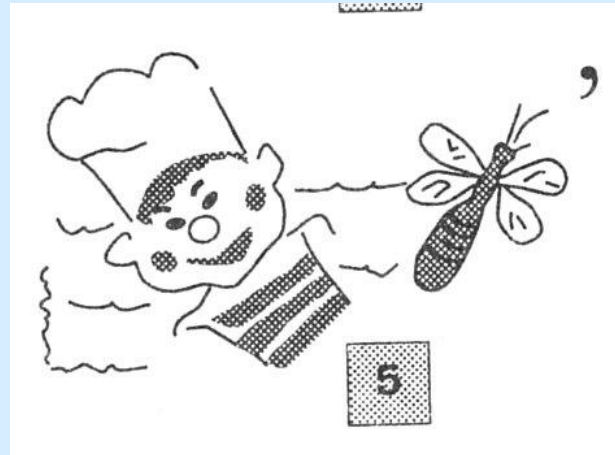

Ребусы

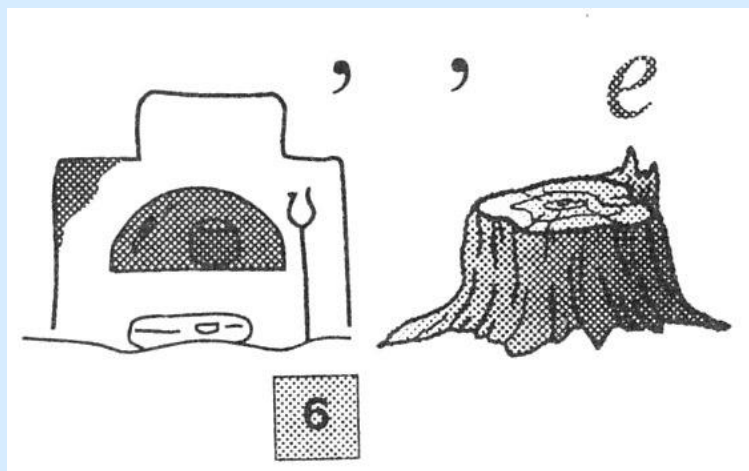

Ребусы

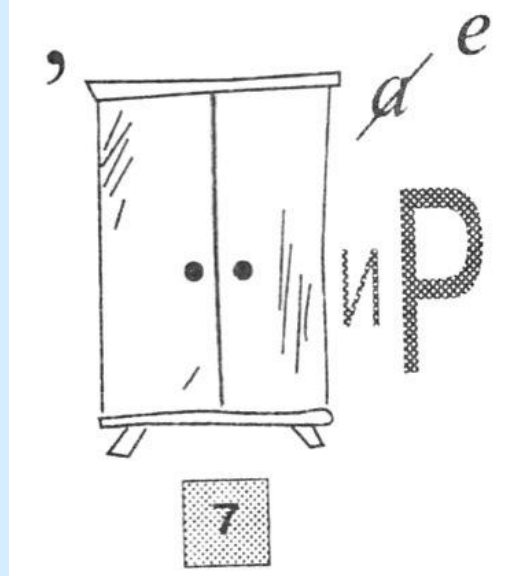

Ребусы

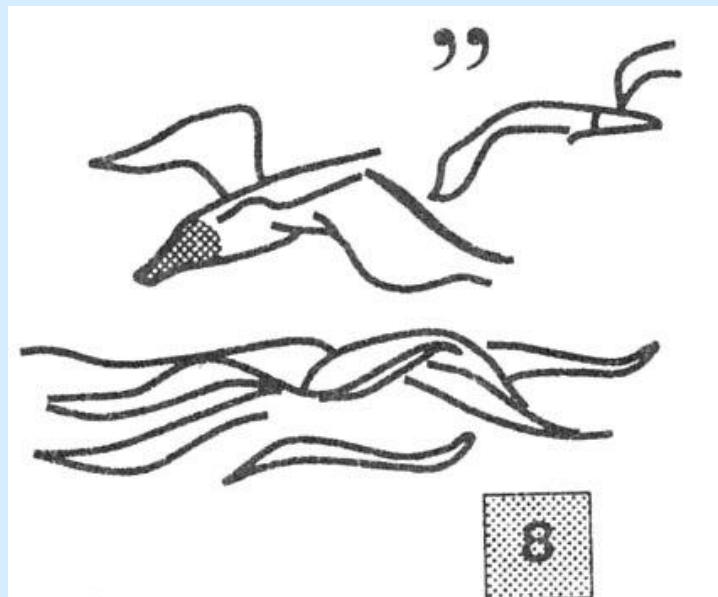

Ребусы

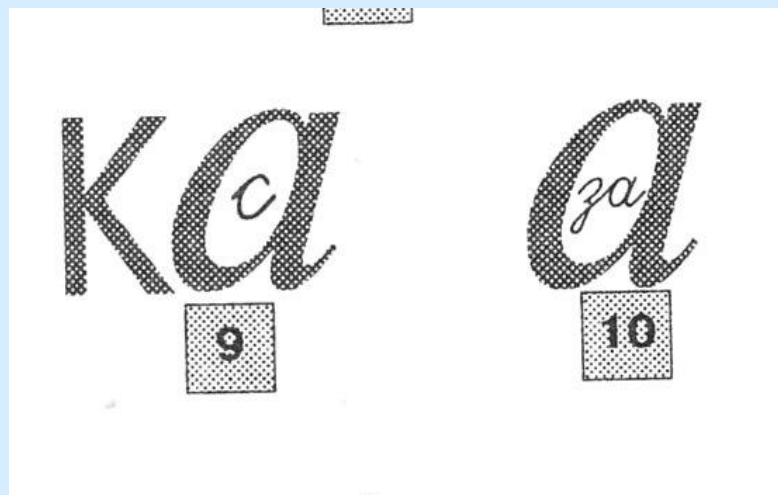

Ребусы



11

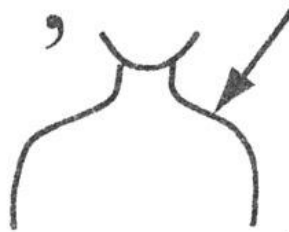

12



Ребусы

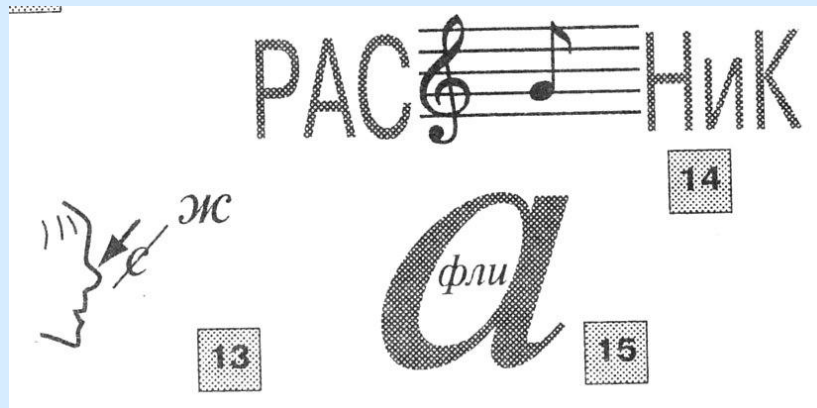

Ребусы

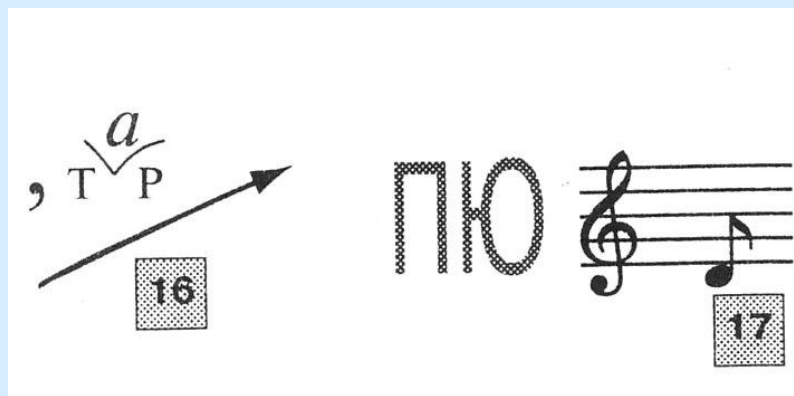

Ребусы



Ребусы

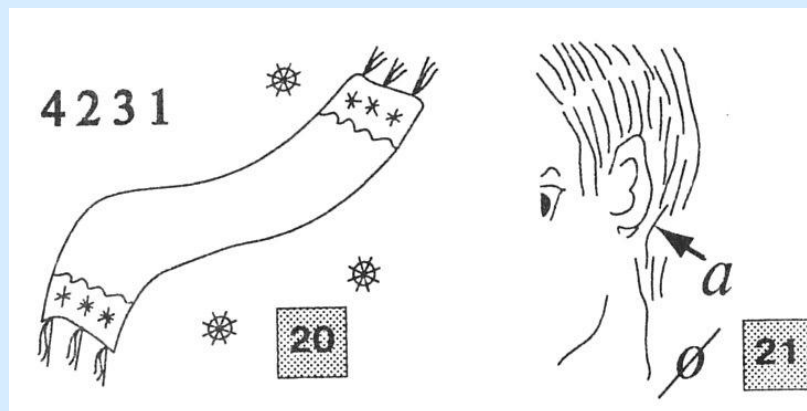

Ребусы

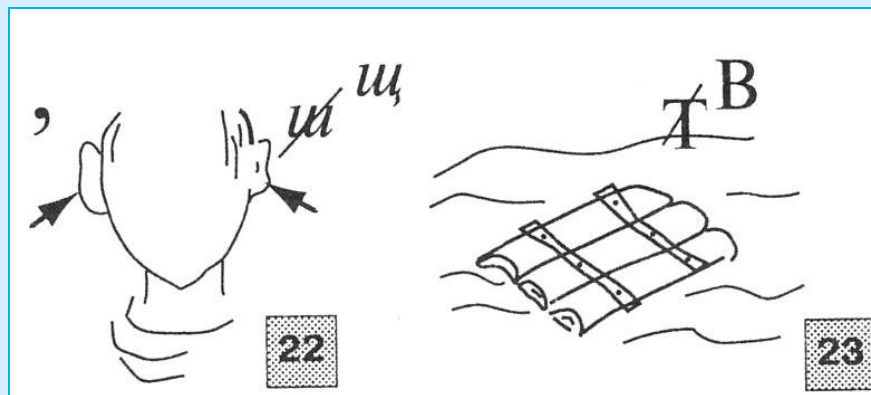

Ребусы



24



25



Ребусы

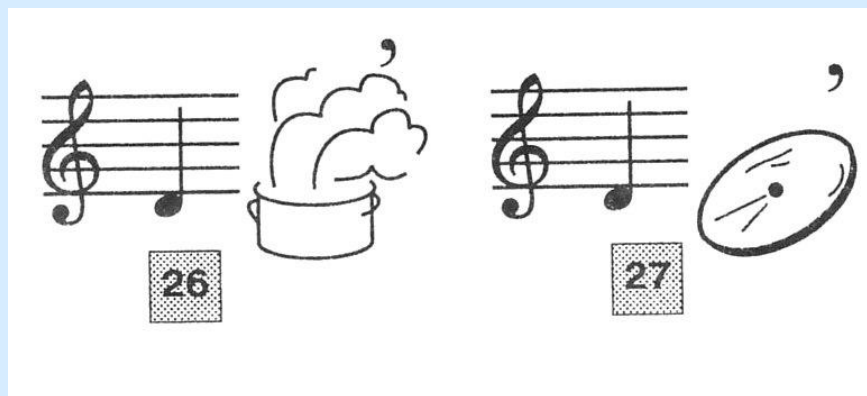

Ребусы

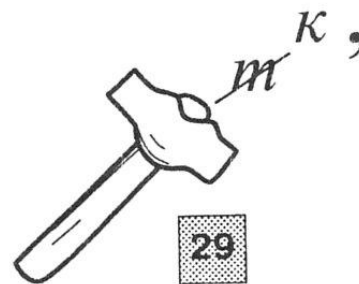
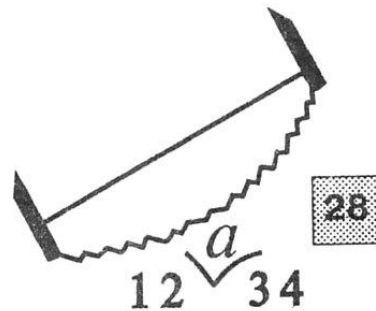

Ребусы

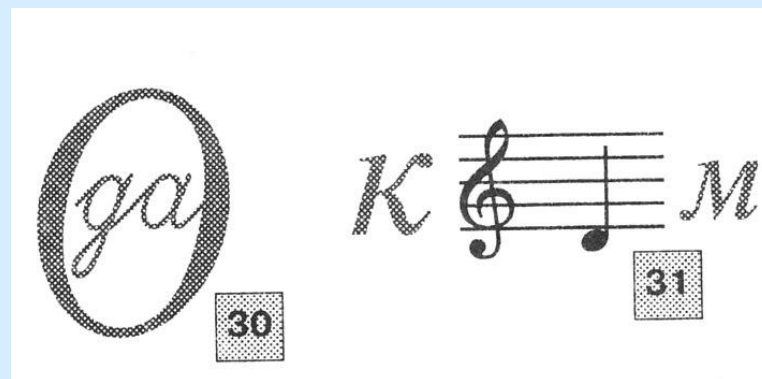

Ребусы

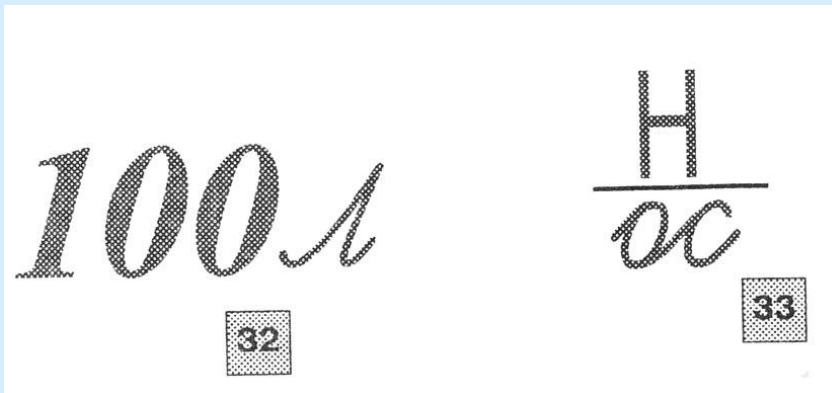

Ребусы

БА
—
Н

34

М
—
ВА

35



Ребусы

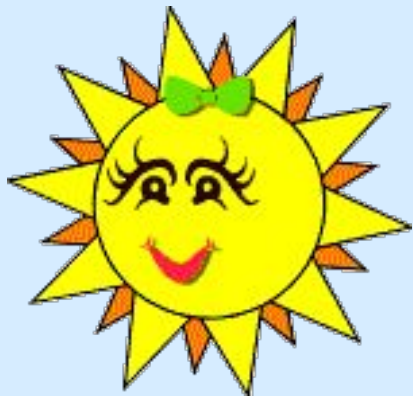

Удачи!
Спасибо за участие!

Разработку презентации «Ребусы»
выполнила
Учитель технологии
Надежина Елена Василье