

Уравнение

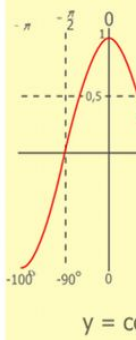

$$\begin{array}{r} 1 \\ 2500 \\ \times 42 \\ \hline 210 \\ + 84 \\ \hline 105000 \end{array}$$

- $2 \times 2 = 4$
- $3 \times 3 = 9$
- $4 \times 4 = 16$
- $5 \times 5 = 25$
- $6 \times 6 = 36$
- $7 \times 7 = 49$
- $8 \times 8 = 64$
- $9 \times 9 = 81$

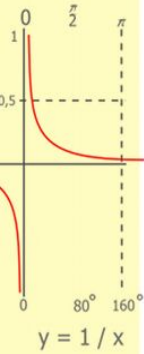
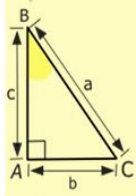
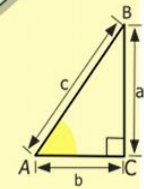
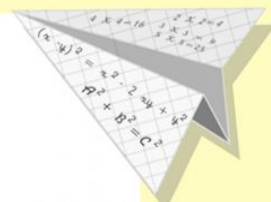
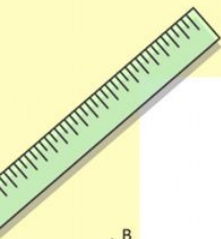

$$\frac{a}{\sin A} = \frac{b}{\sin B} = \frac{c}{\sin C}$$

$$\frac{a}{c} + \frac{b}{c} = \frac{a+b}{c}$$

$$\sin 90^\circ = 1$$



$$\begin{cases} y = \sin 90 \\ x = 25y + 45 \end{cases}$$

$$\begin{cases} y = 1 \\ x = 25 + 45 \\ \hline x = 70 \end{cases}$$

$$(x+y)(x-y) = x^2 - y^2$$

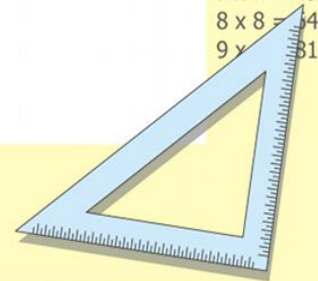

ВЫЧИСЛИТЬ

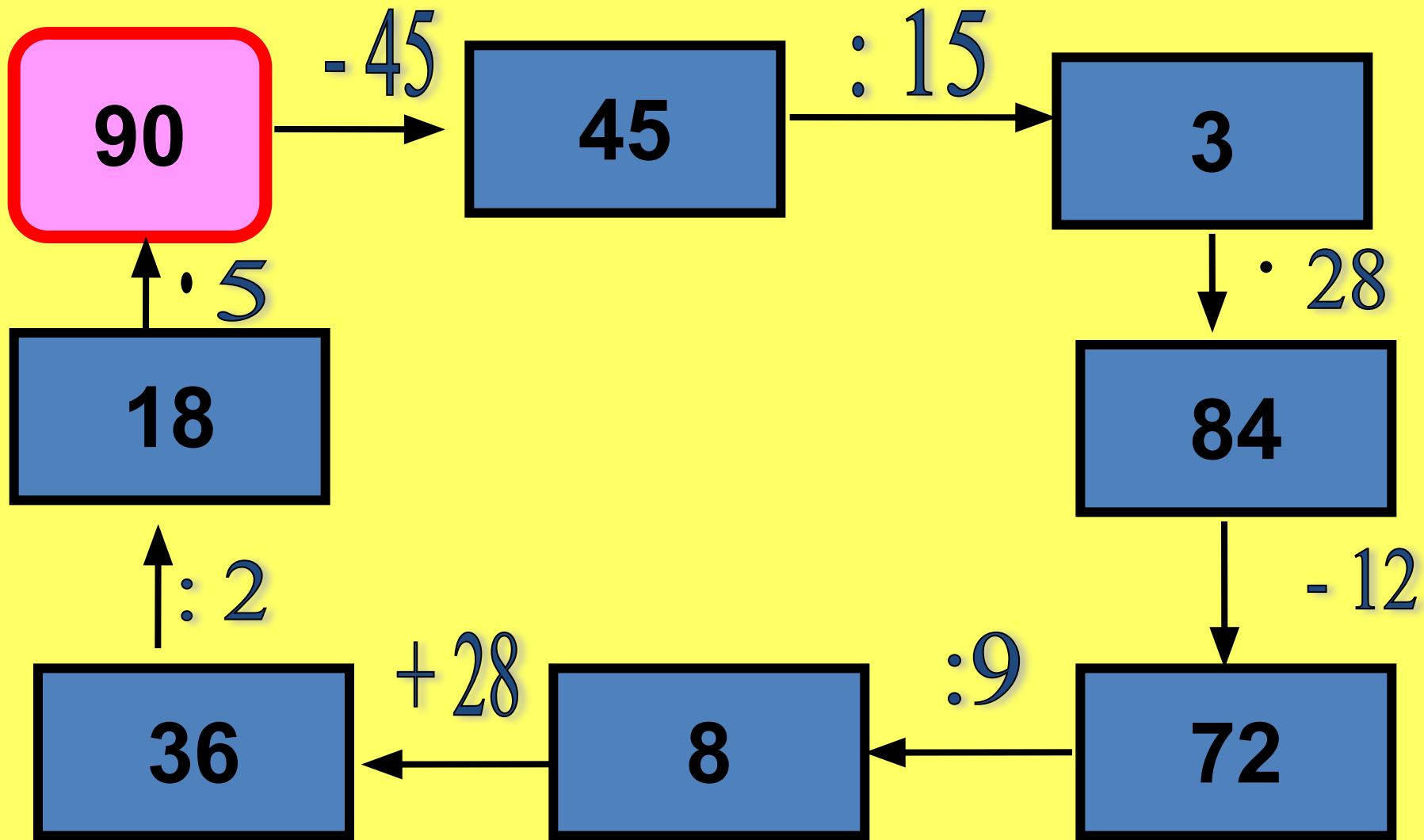

Восстановить цепочку

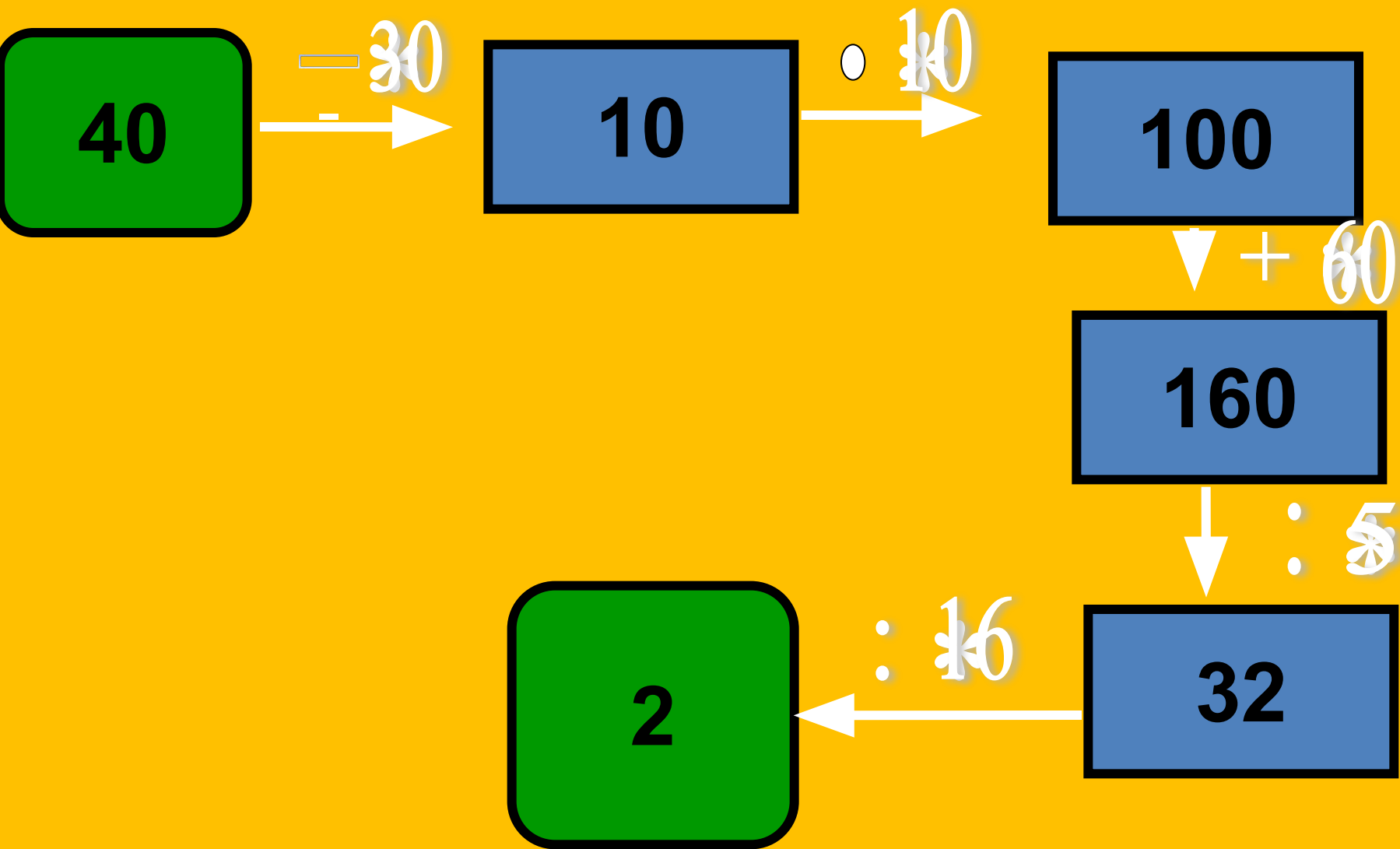

Есть ли среди записанных утверждений уравнения?

1) $28 - 17 = 11$

2) $41 - (x + 17)$

3) $m - 28 = 17$

$m = 45$

4) $5 + 42$

5) $11 + x = 40$

$x = 29$

6) $y + 15 = 3$

Корней нет

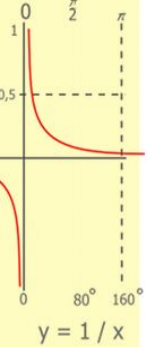
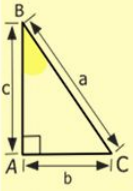
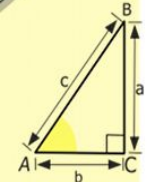
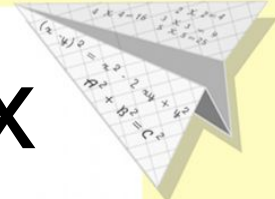
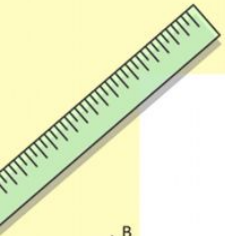

$$\begin{array}{r} 1 \\ 2500 \\ \times 42 \\ \hline 210 \\ + 84 \\ \hline 10500 \end{array}$$

$$\begin{array}{l} 2 \times 2 = 4 \\ 3 \times 3 = 9 \\ 4 \times 4 = 16 \\ 5 \times 5 = 25 \\ 6 \times 6 = 36 \\ 7 \times 7 = 49 \\ 8 \times 8 = 64 \\ 9 \times 9 = 81 \end{array}$$



$$\frac{a}{A} = \frac{b}{\sin B} = \frac{c}{\sin C}$$

$$\frac{a}{c} + \frac{b}{c} = \frac{a+b}{c}$$

$\sin 90^\circ = 1$



$$\begin{cases} y = \sin 90 \\ x = 25y + 45 \end{cases}$$

$$\begin{cases} y = 1 \\ x = 25 + 45 \end{cases}$$

$x = 70$

$$(x+y)(x-y) = x^2 - y^2$$

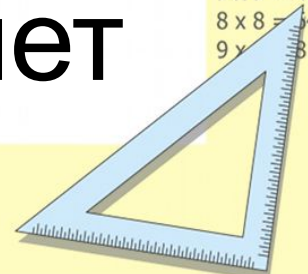

Найдите ошибку

а) $120 - (20 + 15) = 120 - 20 - 15 = 85$

б) $(50 + 12) - 10 = 50 - 10 + 12 = 52$

в) $(8 + 52) - 22 = 52 - 22 + 8 = 38$

г) $69 - (8 + 49) = \del{69 - 49 + 8 - 28} = 69 - 49 - 8 = 12$

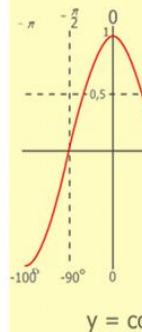
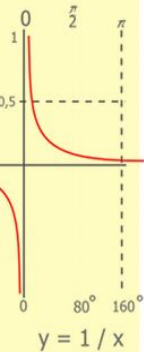
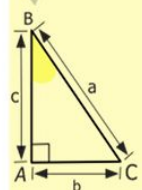
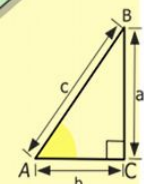
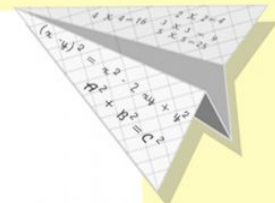
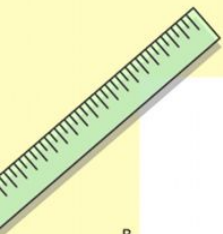

$$\begin{array}{r} 2500 \\ \times 42 \\ \hline 2100 \\ + 8400 \\ \hline 105000 \end{array}$$

- 2 x 2 = 4
- 3 x 3 = 9
- 4 x 4 = 16
- 5 x 5 = 25
- 6 x 6 = 36
- 7 x 7 = 49
- 8 x 8 = 64
- 9 x 9 = 81

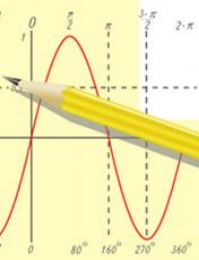

$$\frac{a}{\sin A} = \frac{b}{\sin B} = \frac{c}{\sin C}$$

$$\frac{a}{c} + \frac{b}{c} = \frac{a+b}{c}$$

$$\sin 90^\circ = 1$$



$$\begin{cases} y = \sin 90 \\ x = 25y + 45 \end{cases}$$

$$\begin{cases} y = 1 \\ x = 25 + 45 \\ \hline x = 70 \end{cases}$$

$$(x+y)(x-y) = x^2 - y^2$$

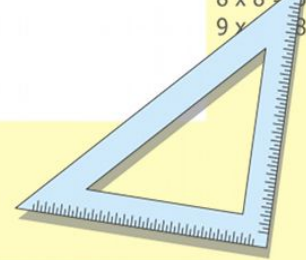

Упростите выражения

а) $135 + 65 + x$

б) $48 + n - 27$

в) $x - 45 - 12$

г) $48 - a + 35$

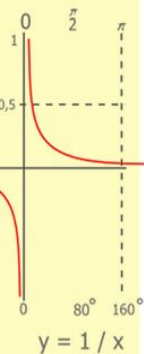
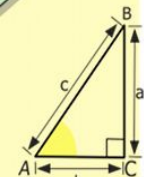
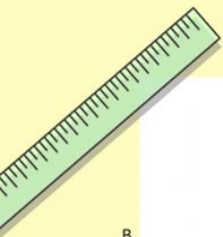

$$\begin{array}{r} 2500 \\ \times 42 \\ \hline 210 \\ + 84 \\ \hline 105000 \end{array}$$



$$\frac{a}{\sin A} = \frac{b}{\sin B} = \frac{c}{\sin C}$$

$$\frac{a}{c} + \frac{b}{c} = \frac{a+b}{c}$$

$$\sin 90^\circ = 1$$



$$\begin{cases} y = \sin 90 \\ x = 25y + 45 \end{cases}$$

$$\begin{cases} y = 1 \\ x = 25 + 45 \\ \hline x = 70 \end{cases}$$

$$(x+y)(x-y) = x^2 - y^2$$

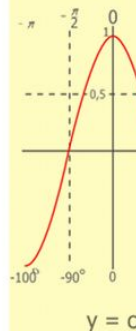
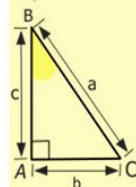
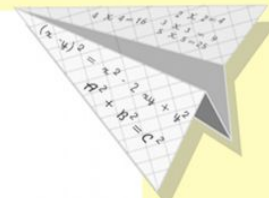

$$\begin{array}{l} 2 \times 2 = 4 \\ 3 \times 3 = 9 \\ 4 \times 4 = 16 \\ 5 \times 5 = 25 \\ 6 \times 6 = 36 \\ 7 \times 7 = 49 \\ 8 \times 8 = 64 \\ 9 \times 9 = 81 \end{array}$$

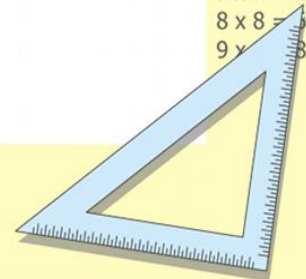

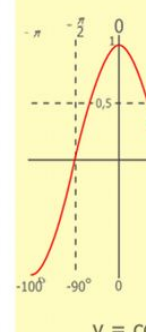
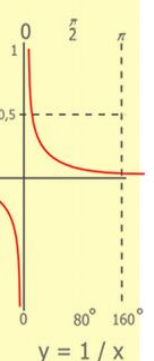
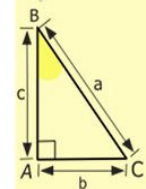
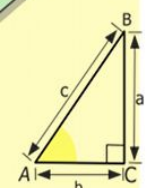
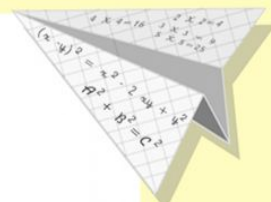
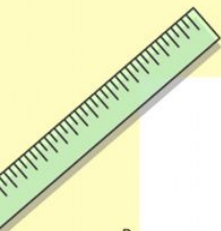

$$\begin{array}{r} 1 \\ \times 2500 \\ \hline 210 \\ + 84 \\ \hline 10500 \end{array}$$

- 2 x 2 = 4
- 3 x 3 = 9
- 4 x 4 = 16
- 5 x 5 = 25
- 6 x 6 = 36
- 7 x 7 = 49
- 8 x 8 = 64
- 9 x 9 = 81



$$\frac{a}{A} = \frac{b}{\sin B} = \frac{c}{\sin C}$$

$$\frac{a}{c} + \frac{b}{c} = \frac{a+b}{c}$$

$$\sin 90^\circ = 1$$



$$\begin{cases} y = \sin 90 \\ x = 25y + 45 \end{cases}$$

$$\begin{cases} y = 1 \\ x = 25 + 45 \\ \hline x = 70 \end{cases}$$

$$(x+y)(x-y) = x^2 - y^2$$

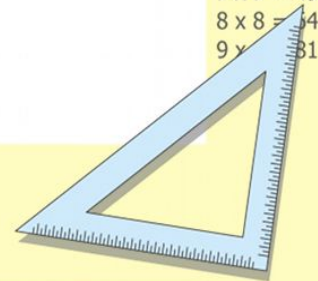

Домашнее задание

П. 10, с.58

№ 396 (б) – решить двумя способами,

№ 397 (в).

№445(а,в)

Дополнительное задание: составить задачу со сказочным сюжетом и решить ее с помощью уравнения.

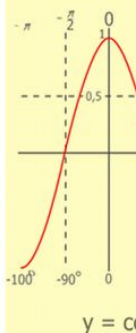
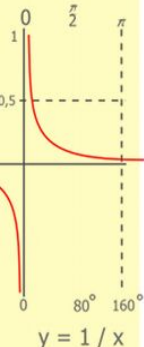
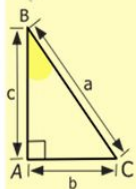
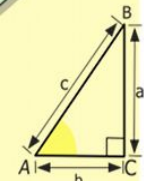
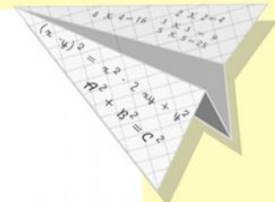
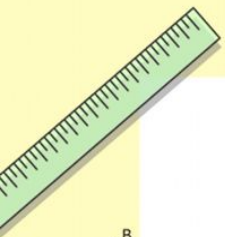

$$\begin{array}{r} 1 \\ 2500 \\ \times 42 \\ \hline 210 \\ + 84 \\ \hline 10500 \end{array}$$

- $2 \times 2 = 4$
- $3 \times 3 = 9$
- $4 \times 4 = 16$
- $5 \times 5 = 25$
- $6 \times 6 = 36$
- $7 \times 7 = 49$
- $8 \times 8 = 64$
- $9 \times 9 = 81$



$$\frac{a}{\sin A} = \frac{b}{\sin B} = \frac{c}{\sin C}$$

$$\frac{a}{c} + \frac{b}{c} = \frac{a+b}{c}$$

$$\sin 90^\circ = 1$$



$$\begin{cases} y = \sin 90 \\ x = 25y + 45 \end{cases}$$
$$\begin{cases} y = 1 \\ x = 25 + 45 \end{cases}$$
$$\frac{x}{70}$$

$$(x+y)(x-y) = x^2 - y^2$$

