

# Параллельные прямые

## *Задачи на готовых чертежах*

- Признаки параллельности прямых
- Свойства параллельных прямых

*Выполнила: Панова Вера  
Александровна  
Учитель математики  
МБОУ СОШ № 201 «Согласие»  
г. Екатеринбург*

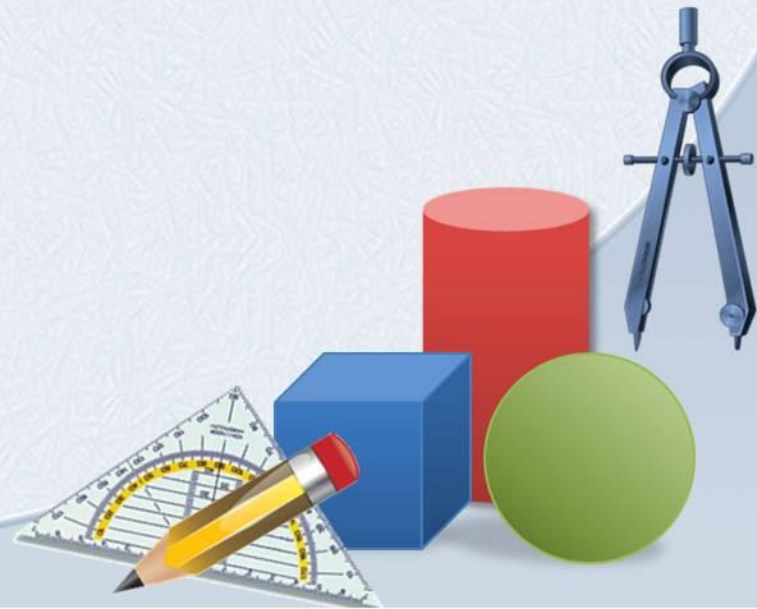

# Укажите номера рисунков, на которых изображены параллельные прямые

1

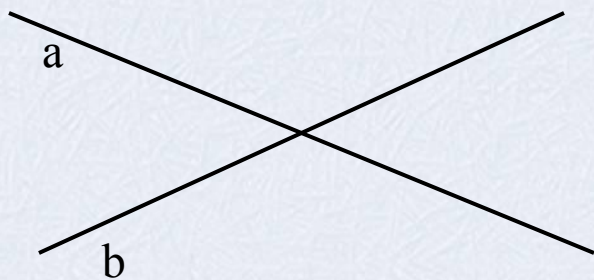

3

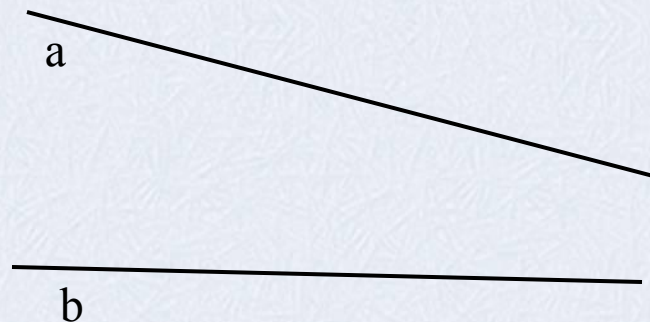

2

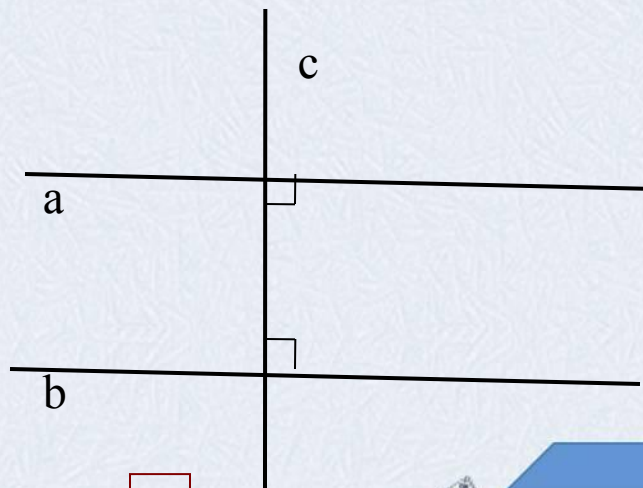

4

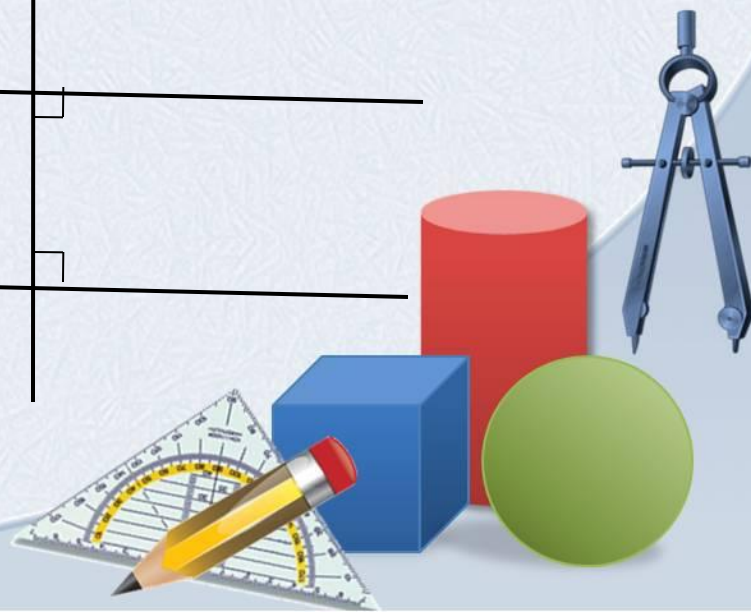

1. Назовите накрест лежащие углы при прямых  $a$  и  $b$  и секущей  $c$ .
2. Назовите односторонние углы при прямых  $b$  и  $c$  и секущей  $a$ .
3. Назовите соответственные углы при прямых  $a$  и  $c$  и секущей  $b$ .

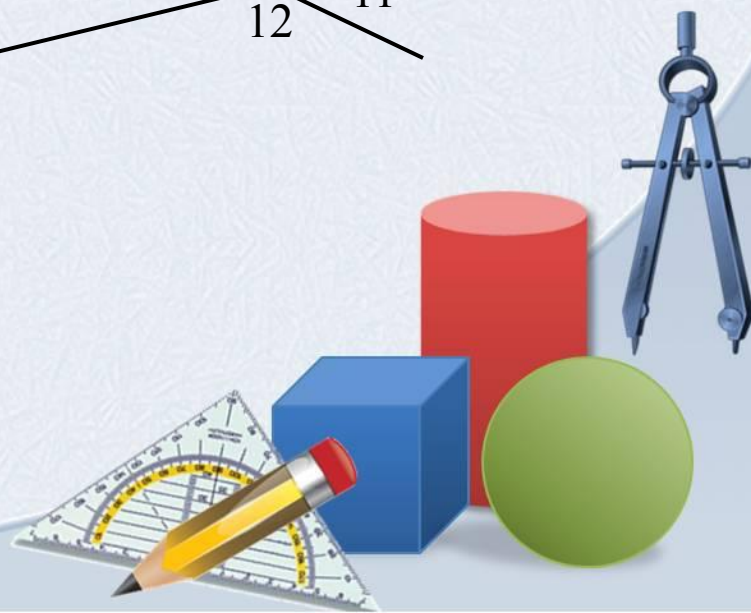
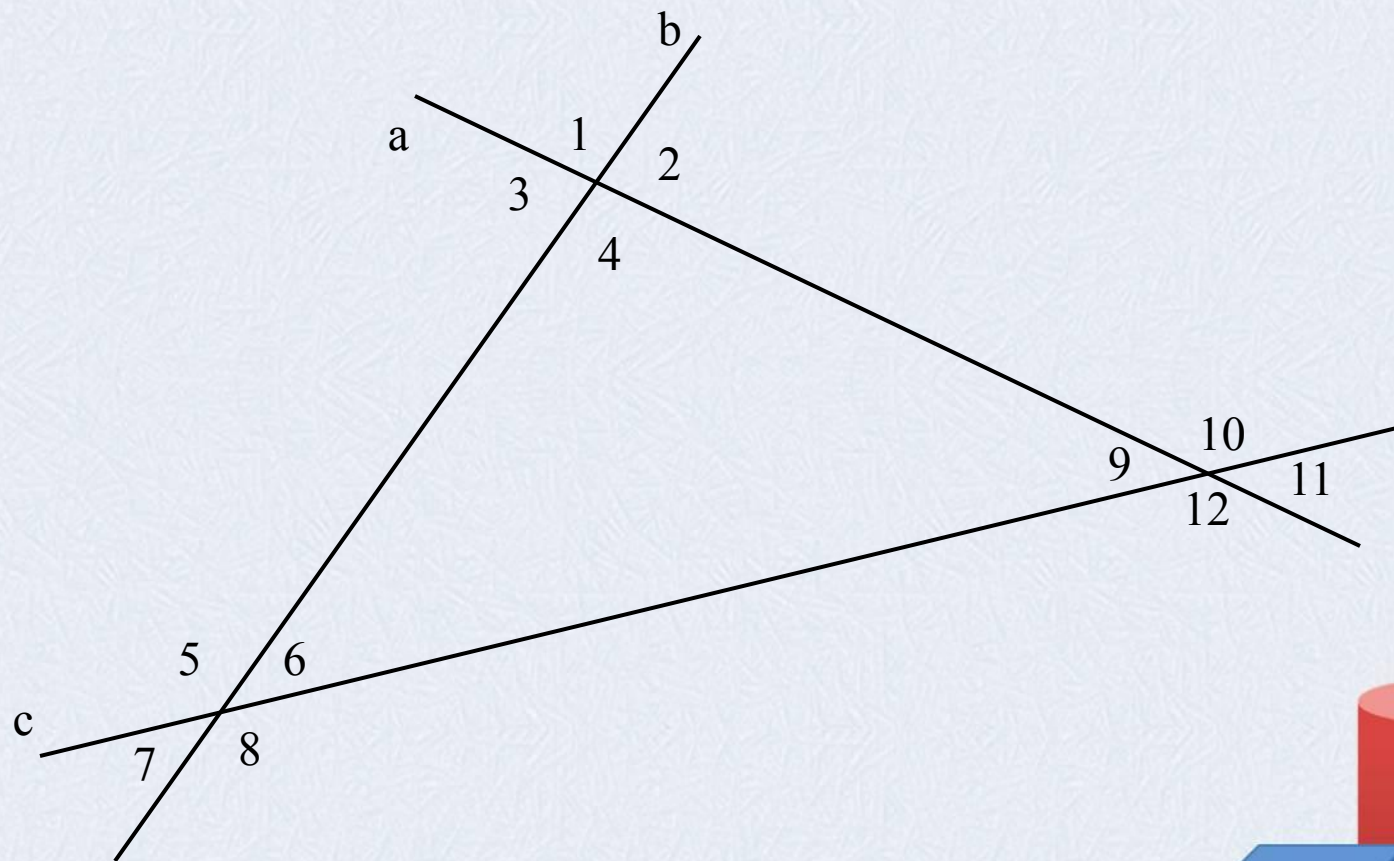

Дано:  $\angle 1 = 32^\circ$ ,  $\angle 2 = 32^\circ$

Доказать:  $a \parallel b$ .

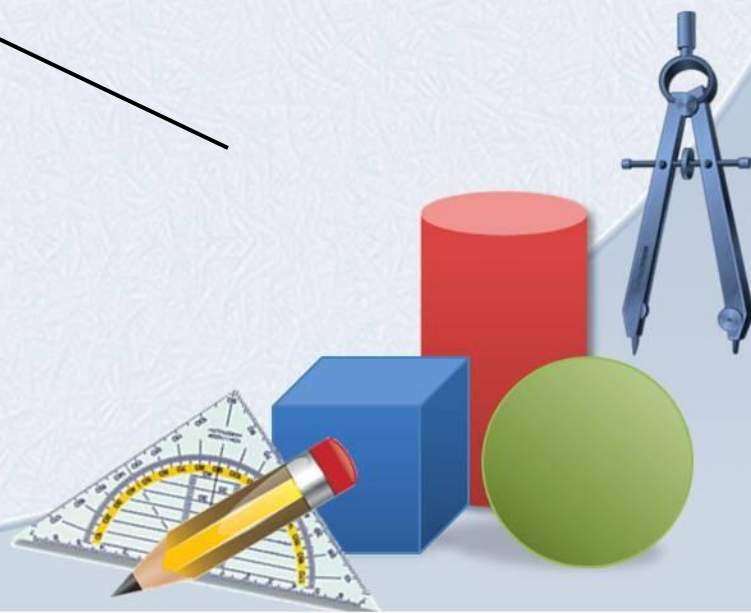
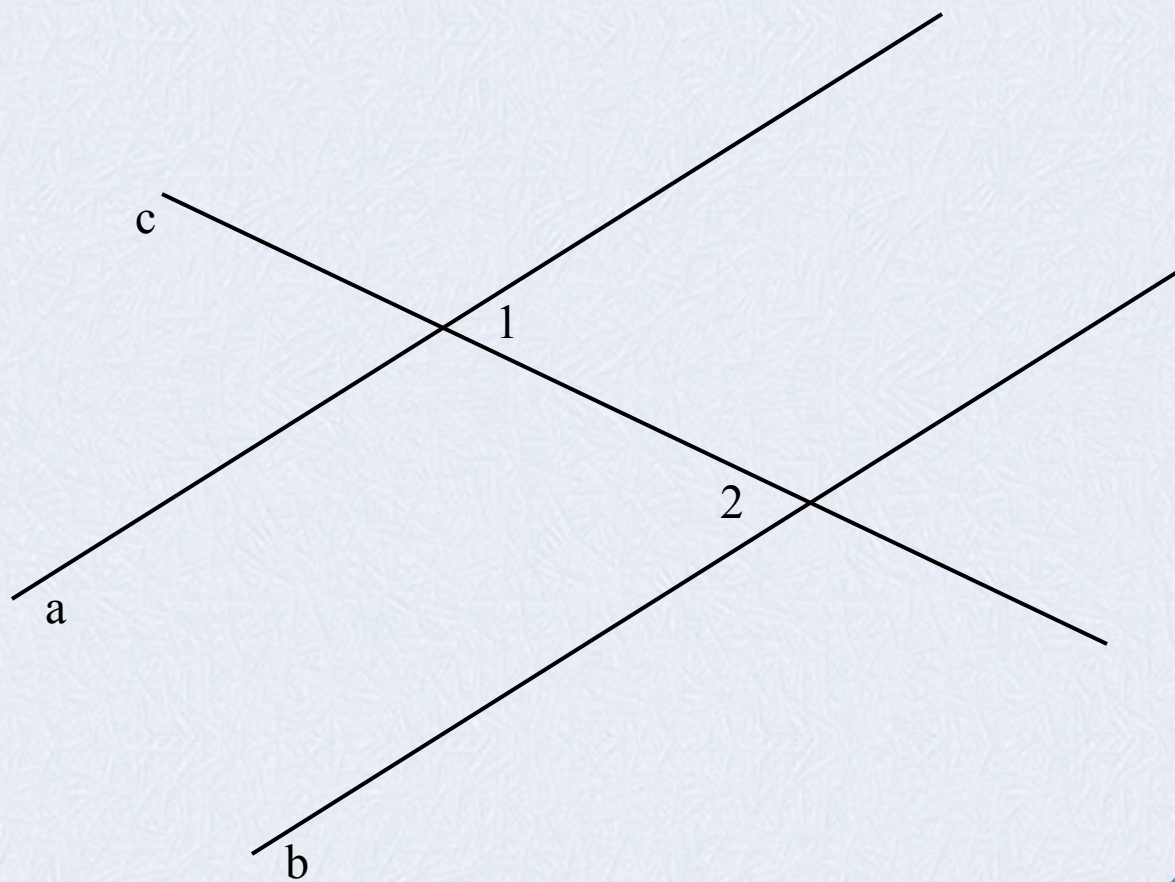

Дано:  $\angle 1 = 48^\circ, \angle 2 = 132^\circ$

Доказать:  $a \parallel b$ .

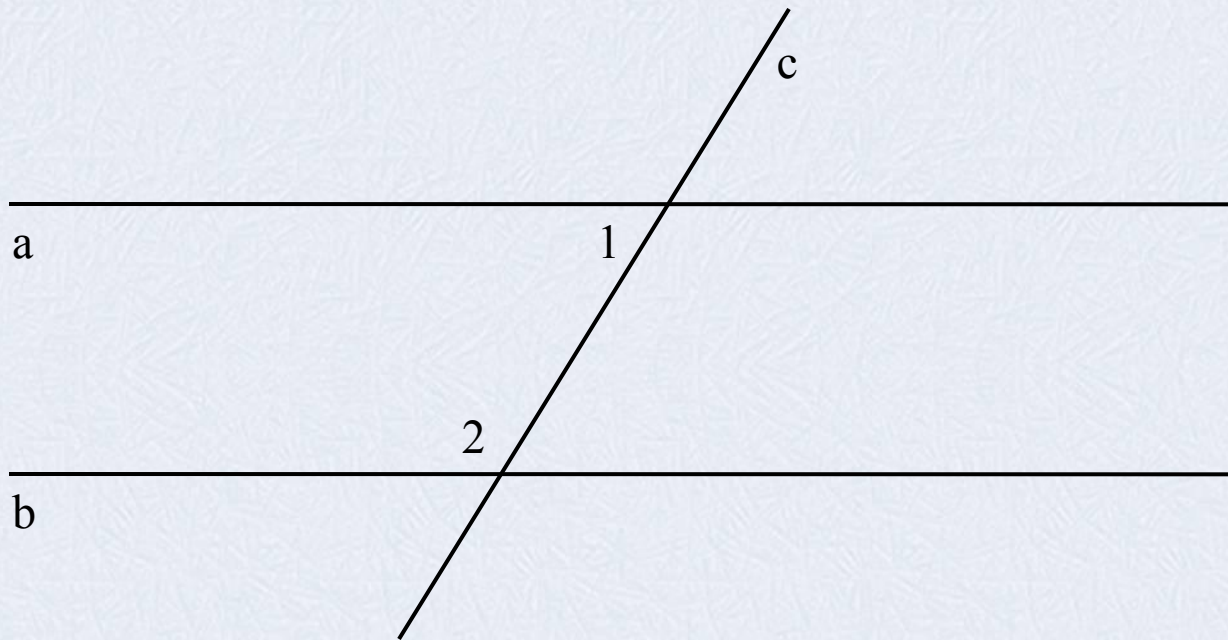

Дано:  $\angle 1 = 47^\circ$ ,  $\angle 2 = 133^\circ$

Доказать:  $a \parallel b$ .

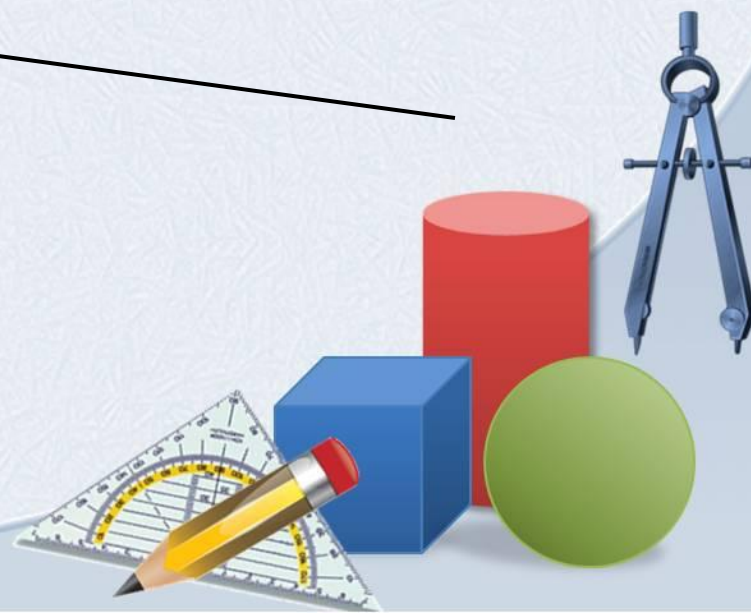
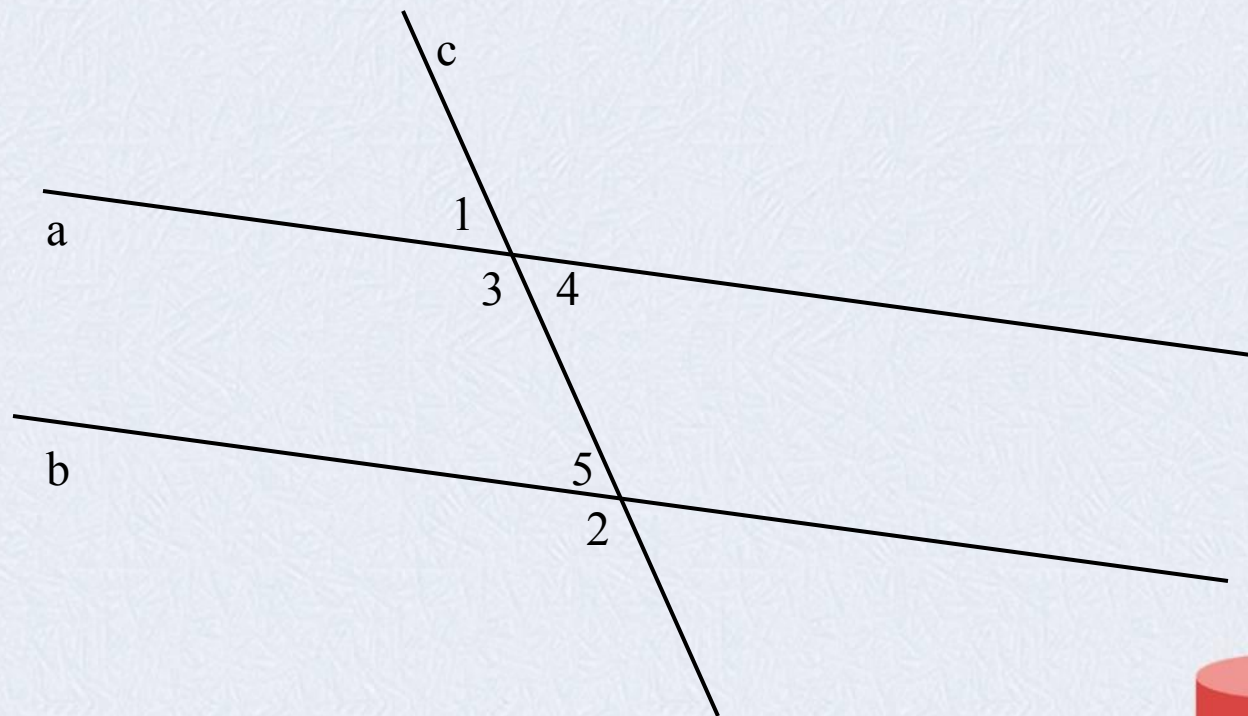

Параллельны ли прямые  $a$  и  $b$ ?

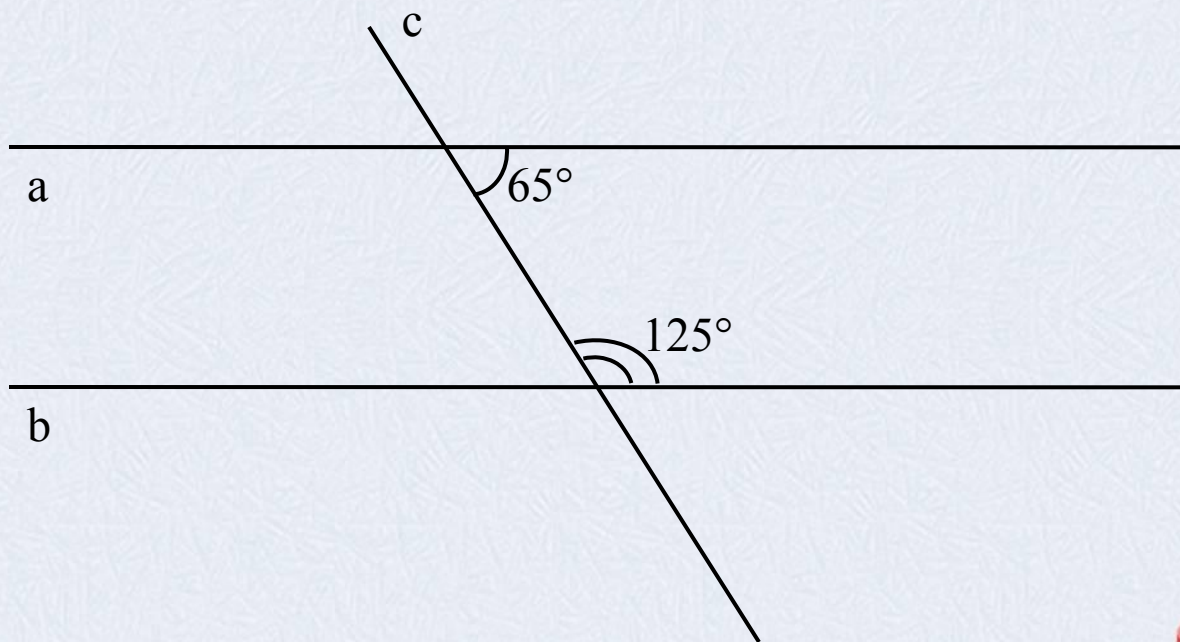

Доказать:  $a \parallel b$ .

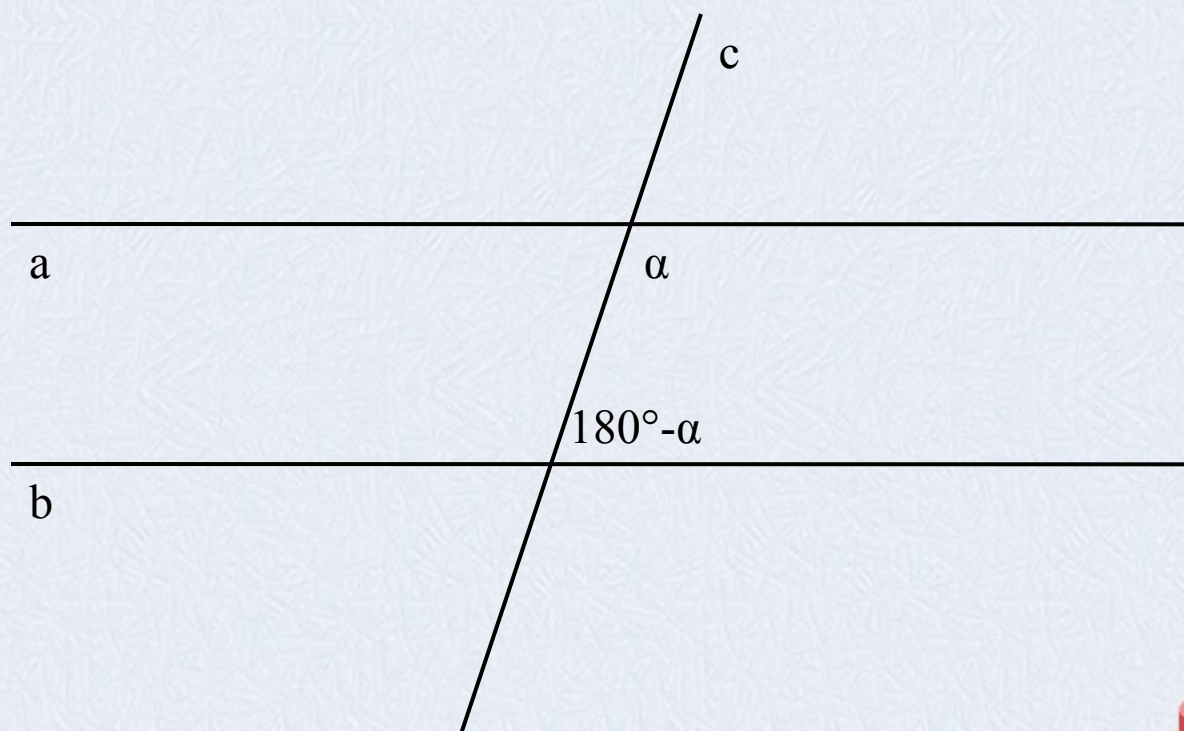



Параллельны ли прямые  $a$  и  $b$ ?

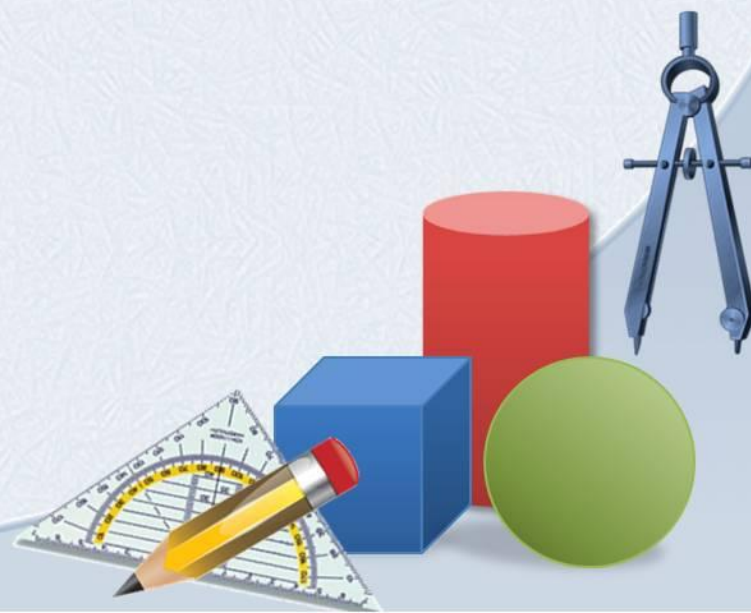
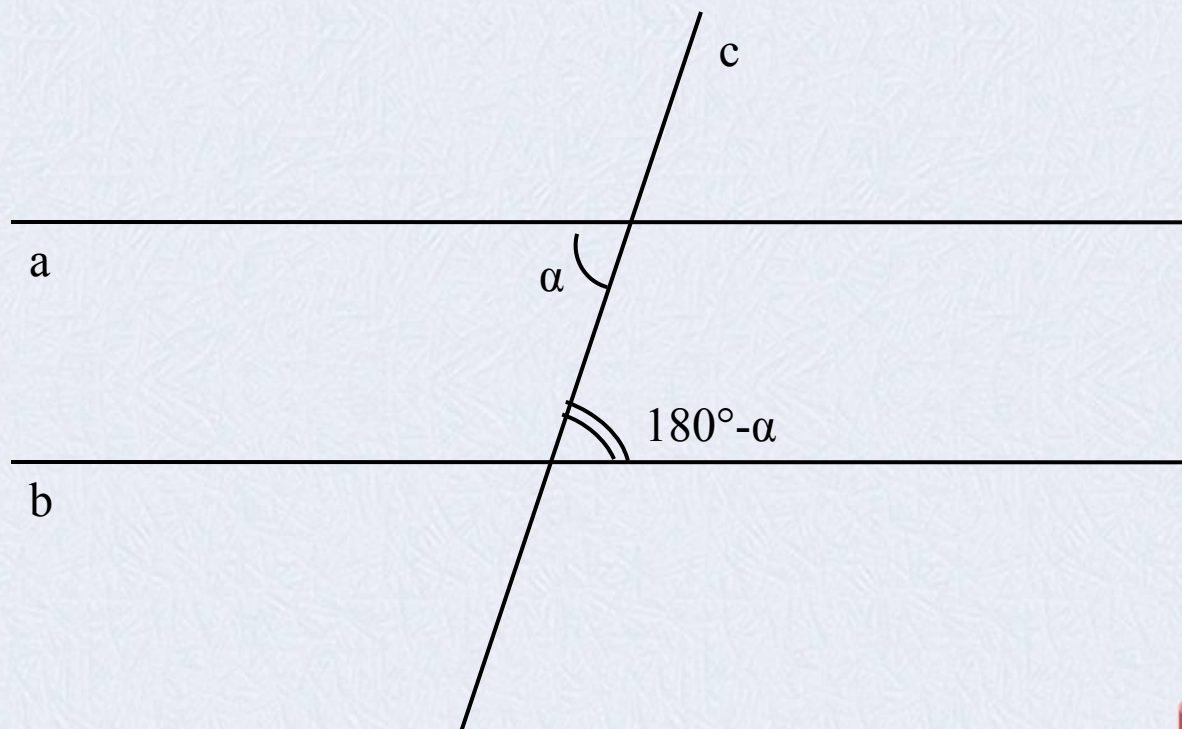

Параллельны ли прямые  $a$  и  $b$ ?

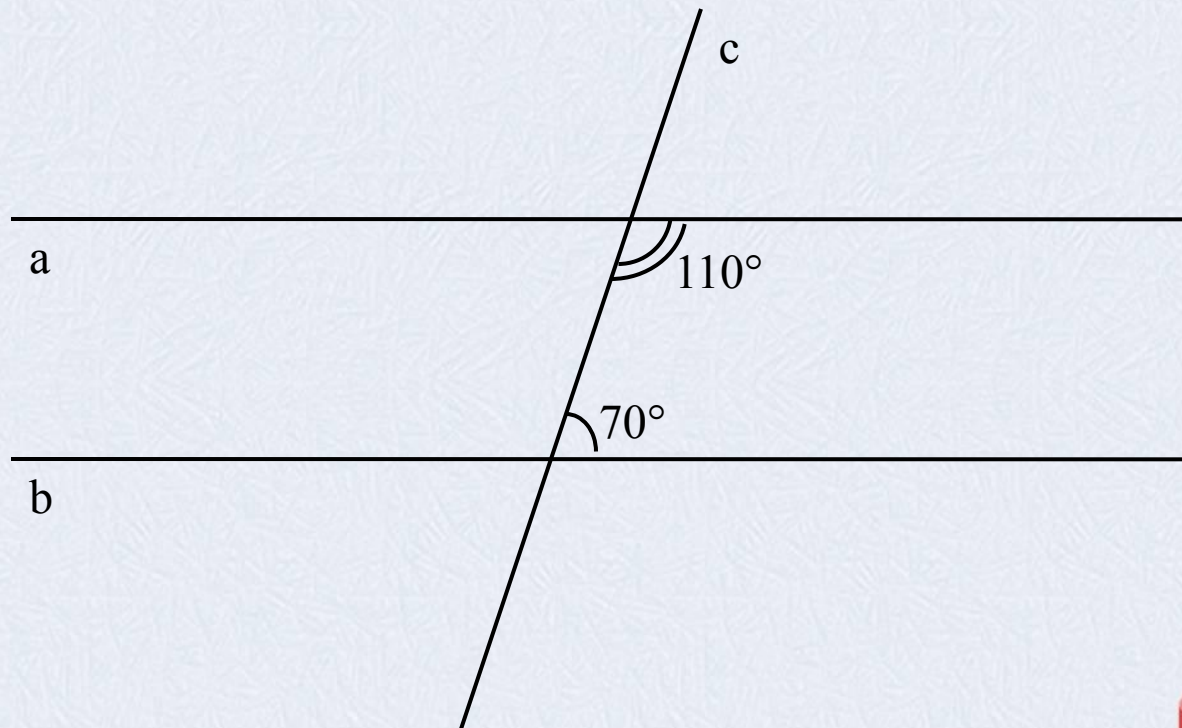

Параллельны ли прямые  $a$  и  $b$ ?

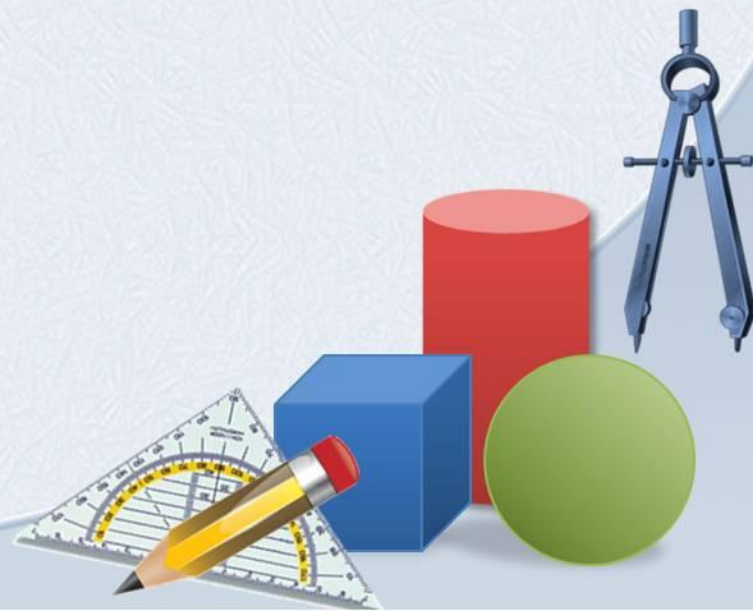
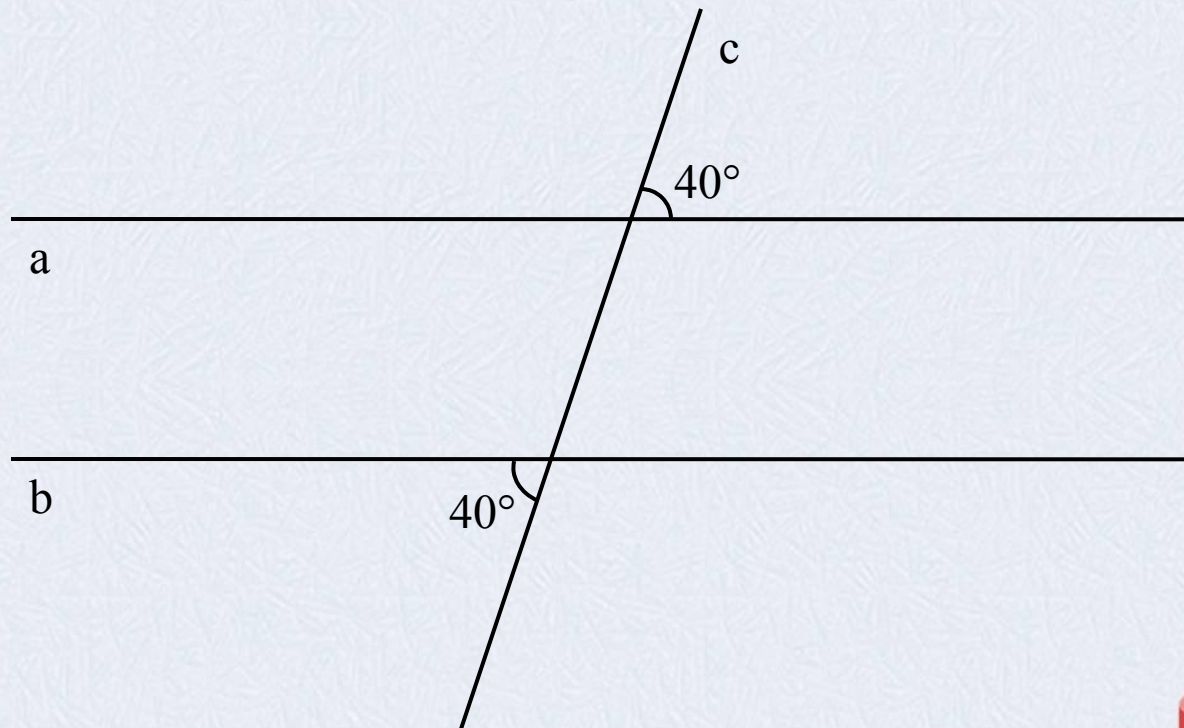

Доказать:  $AB \parallel CD$ .

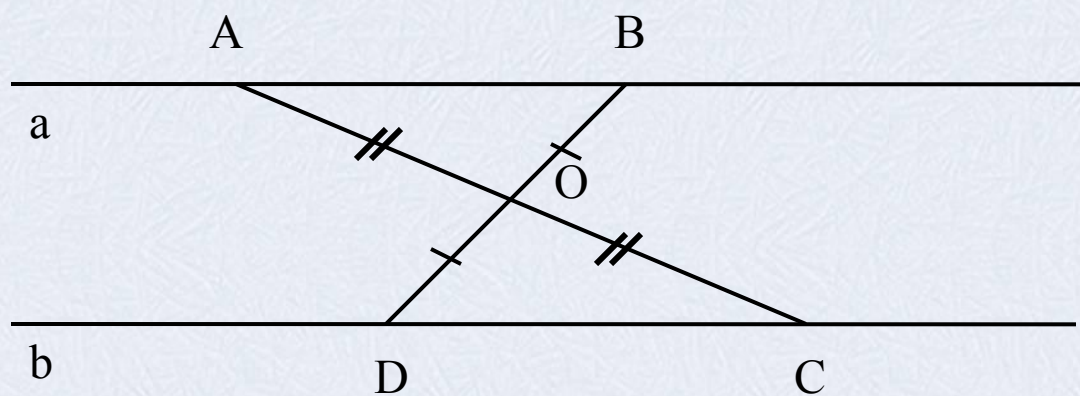

Доказать:  $PE \parallel MK$ .

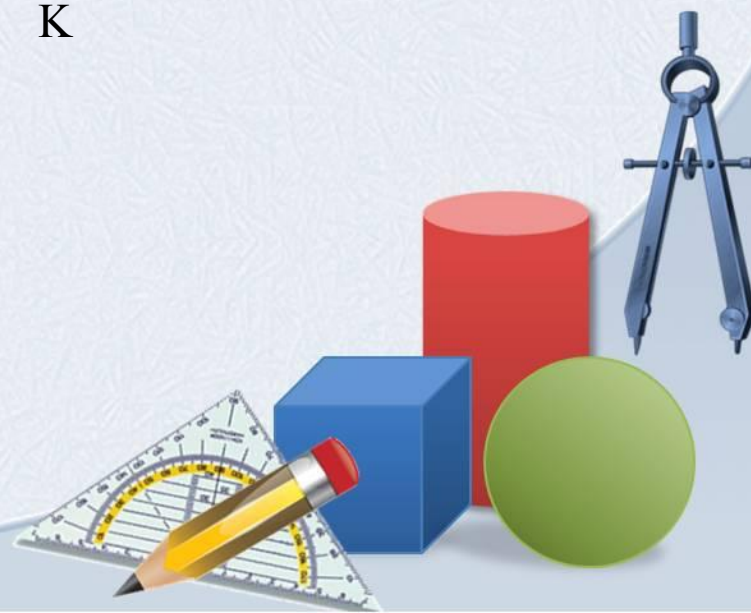
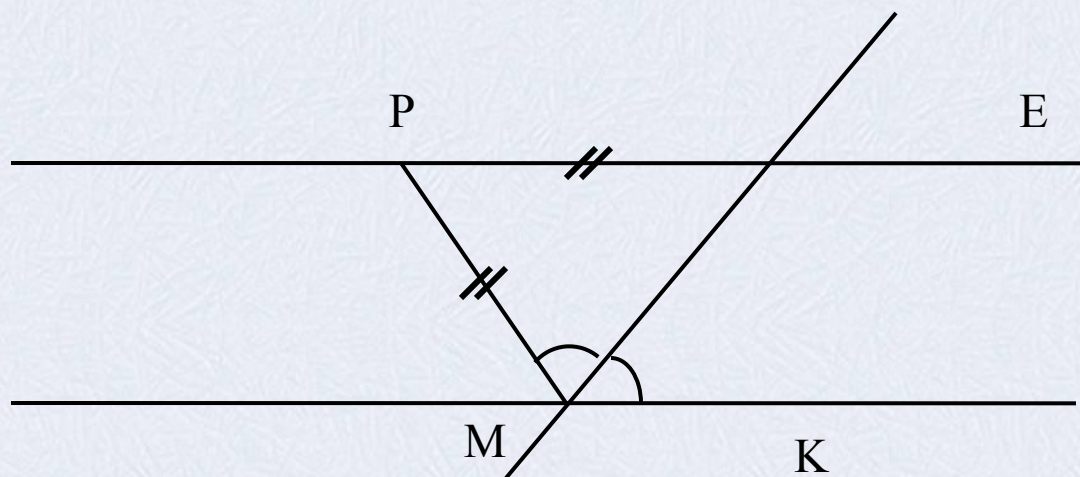

Дано:  $AB=BC$

Параллельны ли прямые  $a$  и  $b$ ?

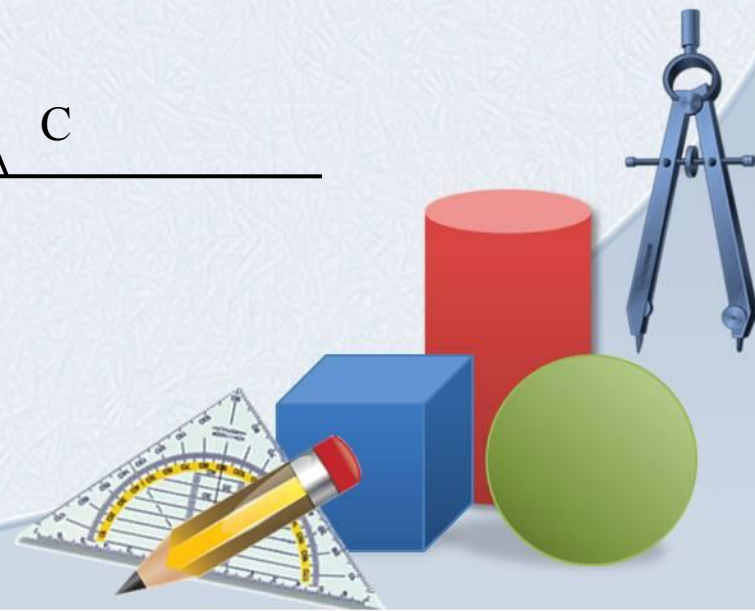
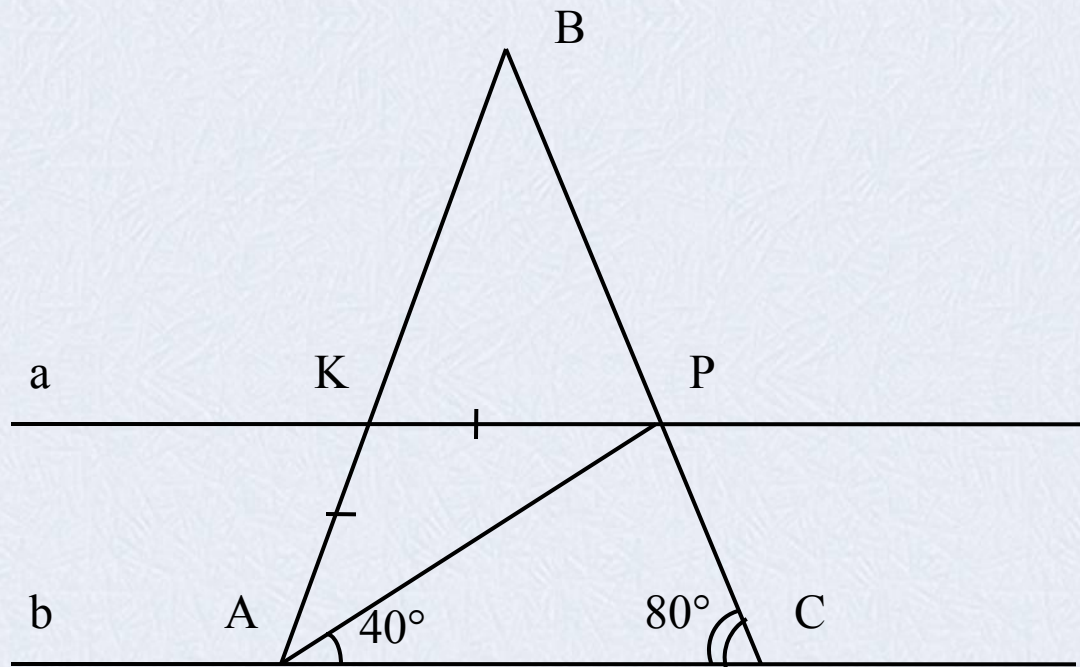

Доказать:  $AB \parallel CD$ ;  $AD \parallel BC$ .

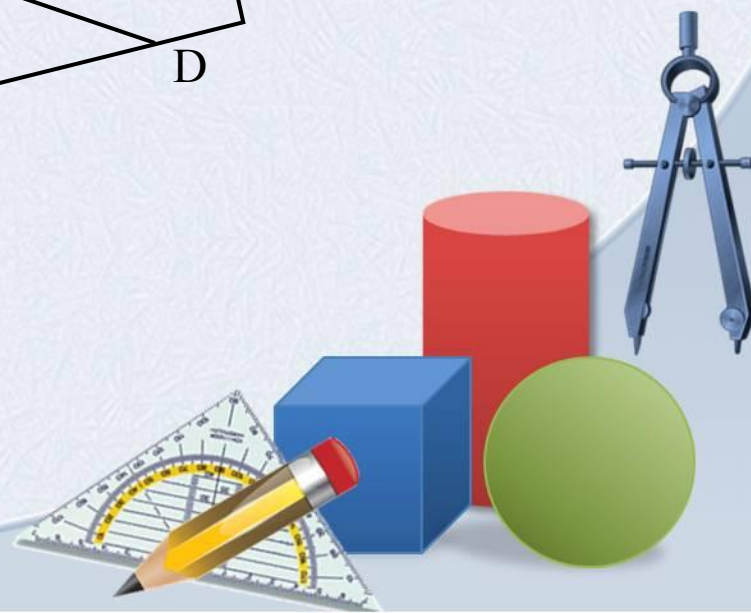
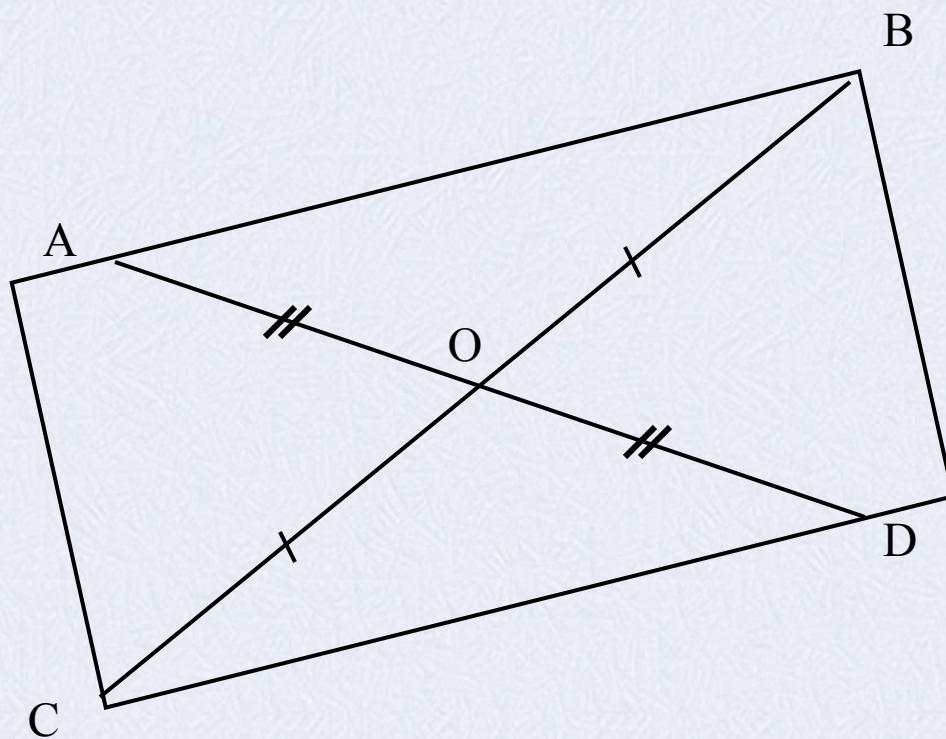

Доказать:  $AB \parallel CD$ ;  $AD \parallel BC$ .

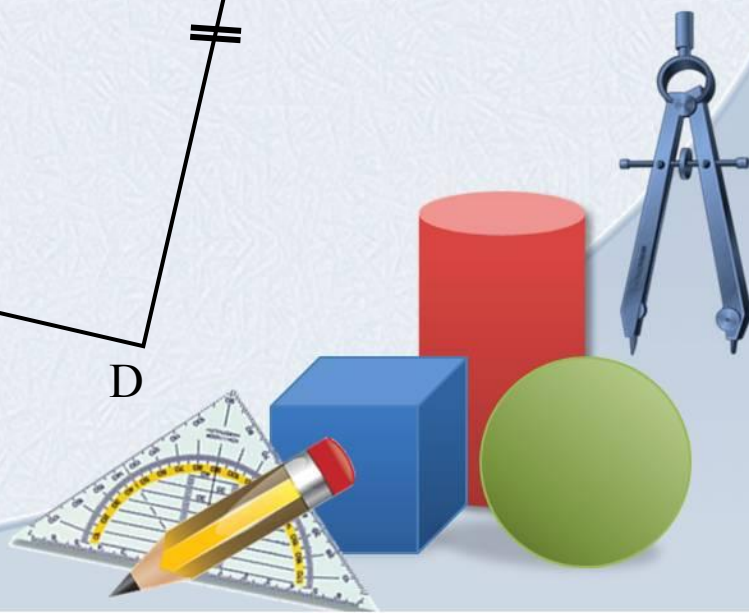
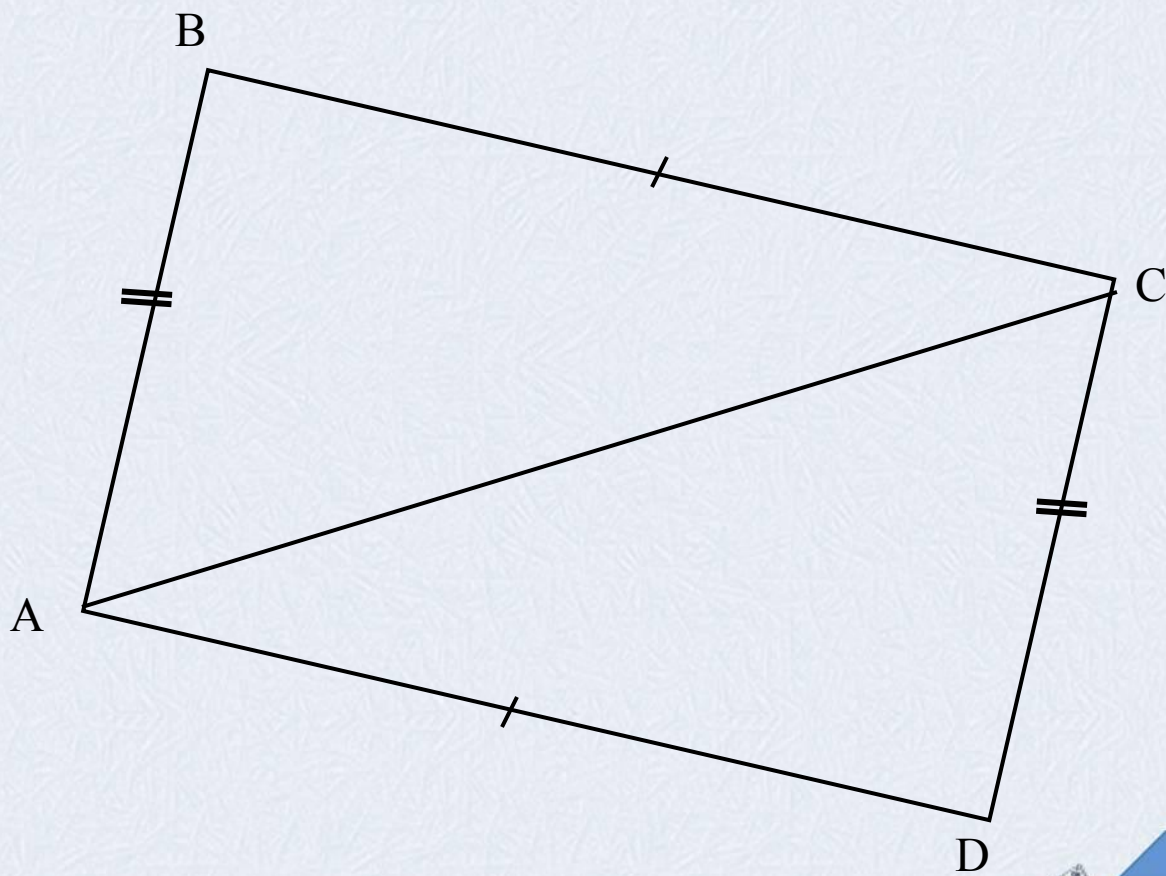



Доказать:  $AB \parallel DE$ .

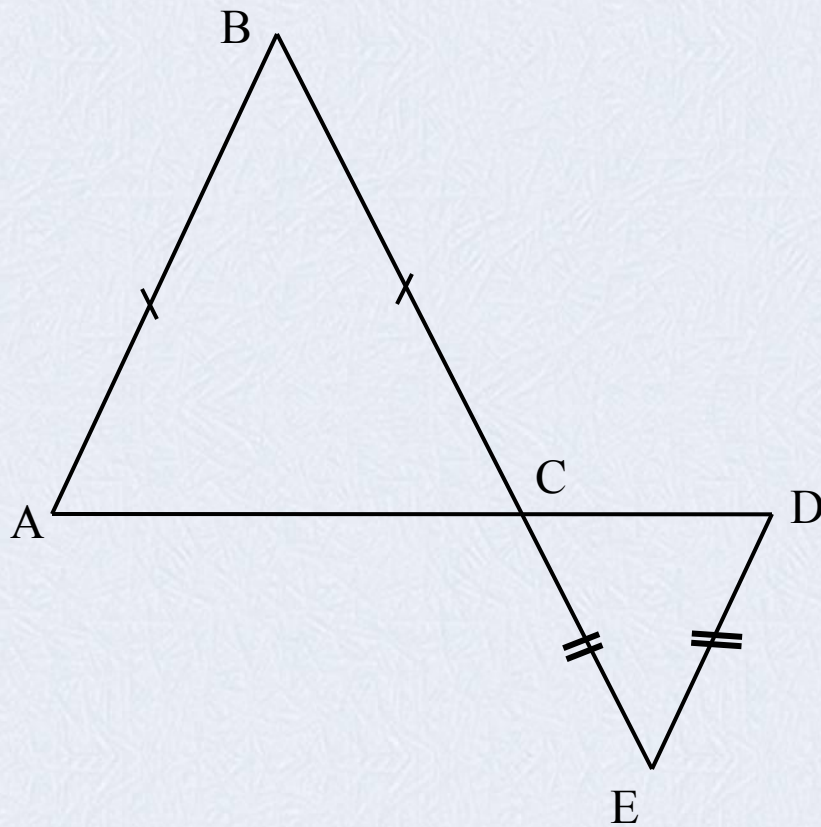

Доказать:  $AB \parallel MN$ .

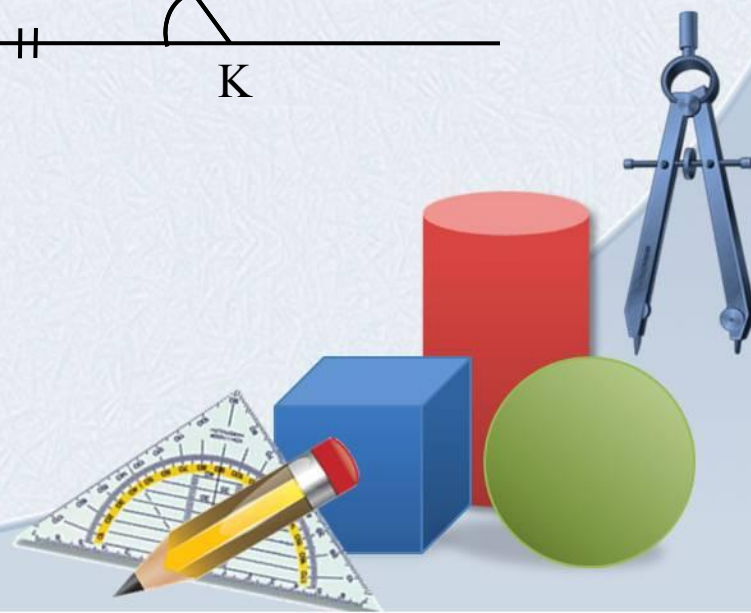
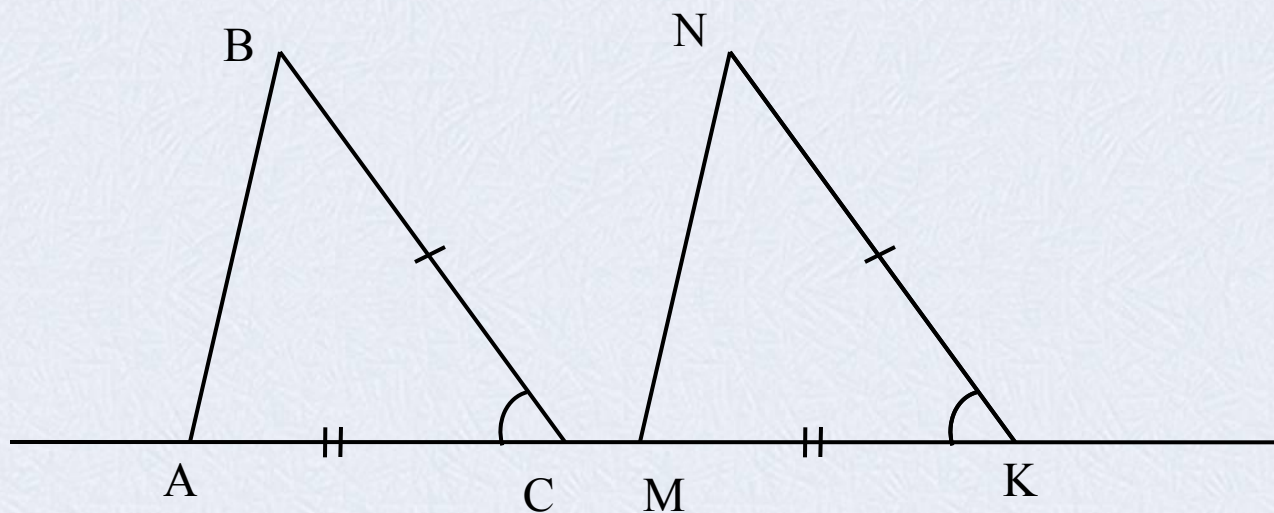

Дано:  $\angle 1 = 75^\circ$ ;  $a \parallel b$ .  
Найти:  $\angle 2$ ,  $\angle 3$ ,  $\angle 4$ .

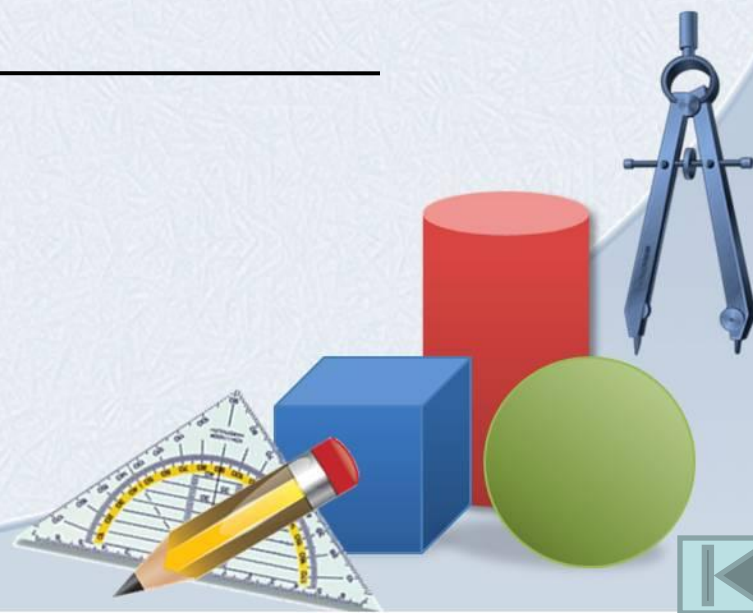
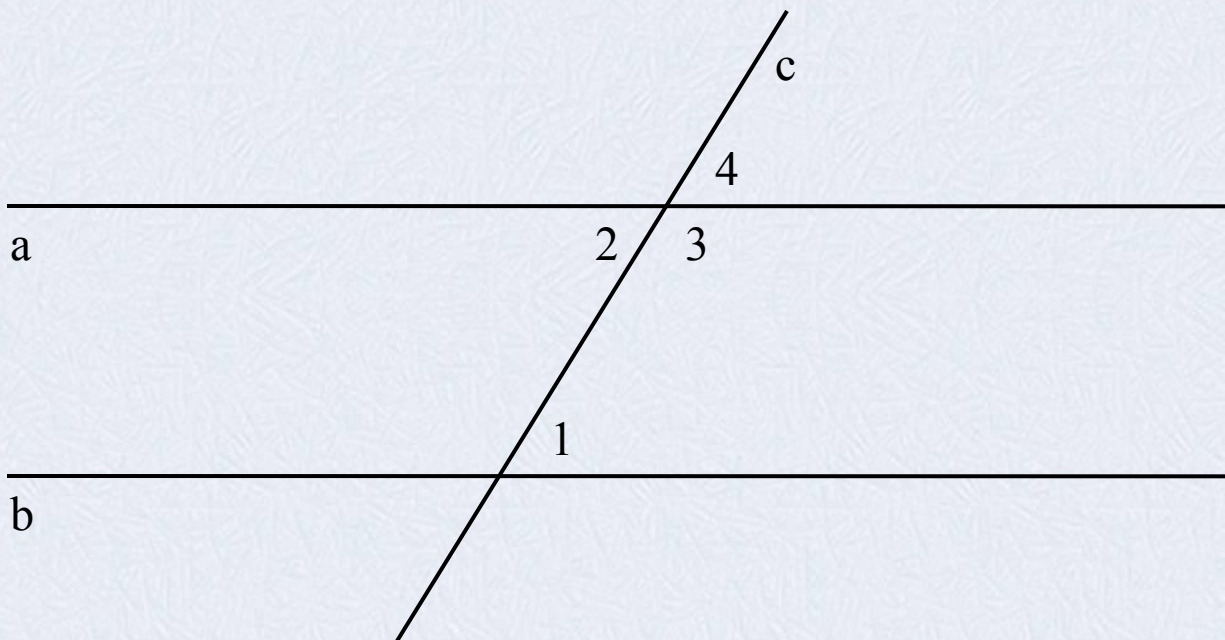

Дано:  $\angle 1 + \angle 2 = 160^\circ$ ;  $a \parallel b$ .  
Найти:  $\angle 3$ ,  $\angle 4$ ,  $\angle 5$ ,  $\angle 6$ .

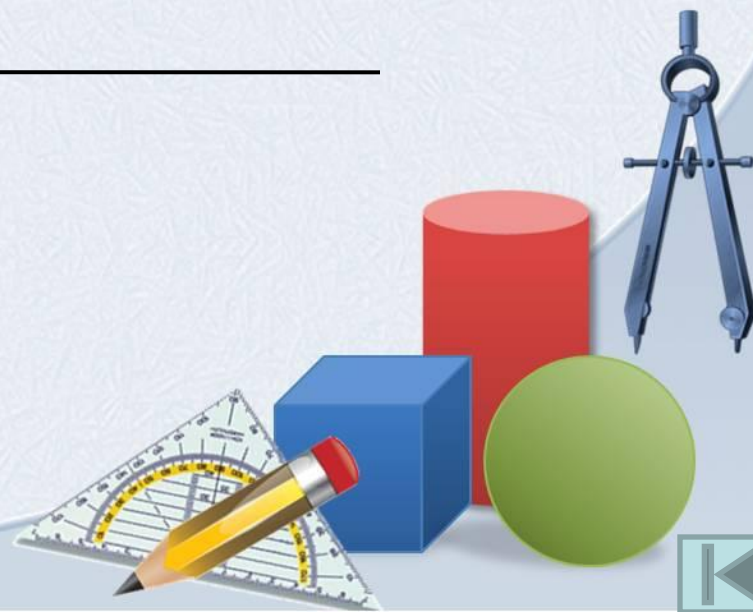
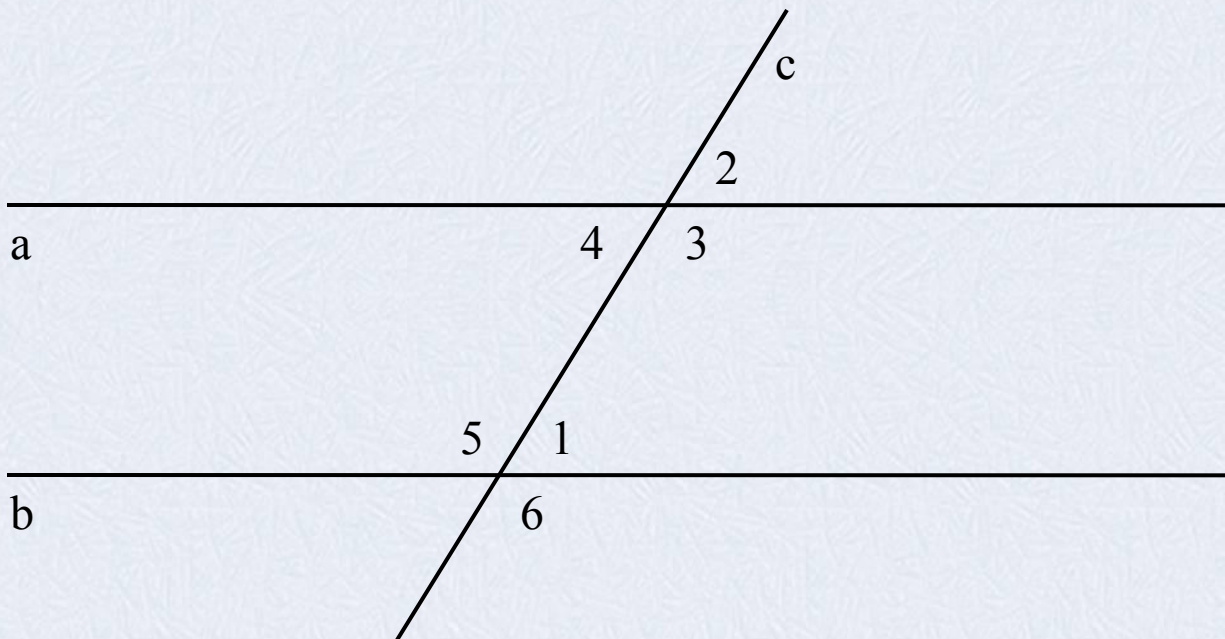

Дано:  $a \parallel b$ ;  $\angle 1$  в 4 раза меньше  $\angle 2$ .  
Найти:  $\angle 3$ .

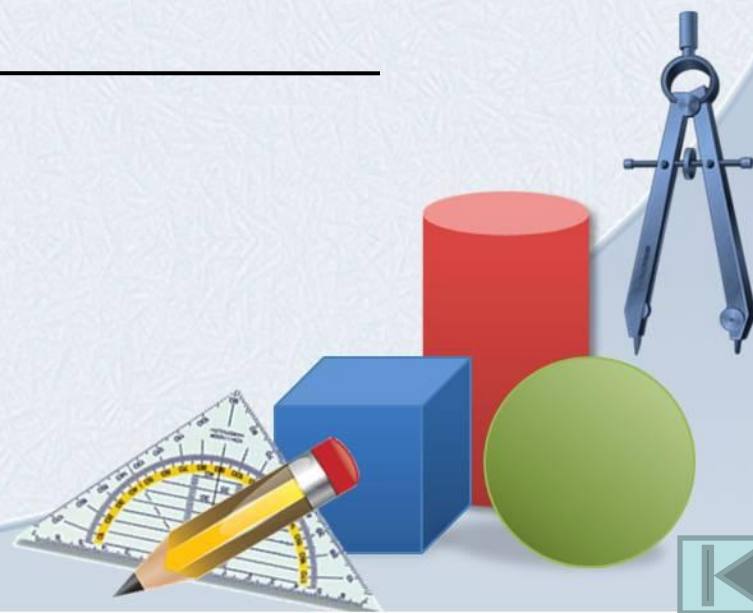
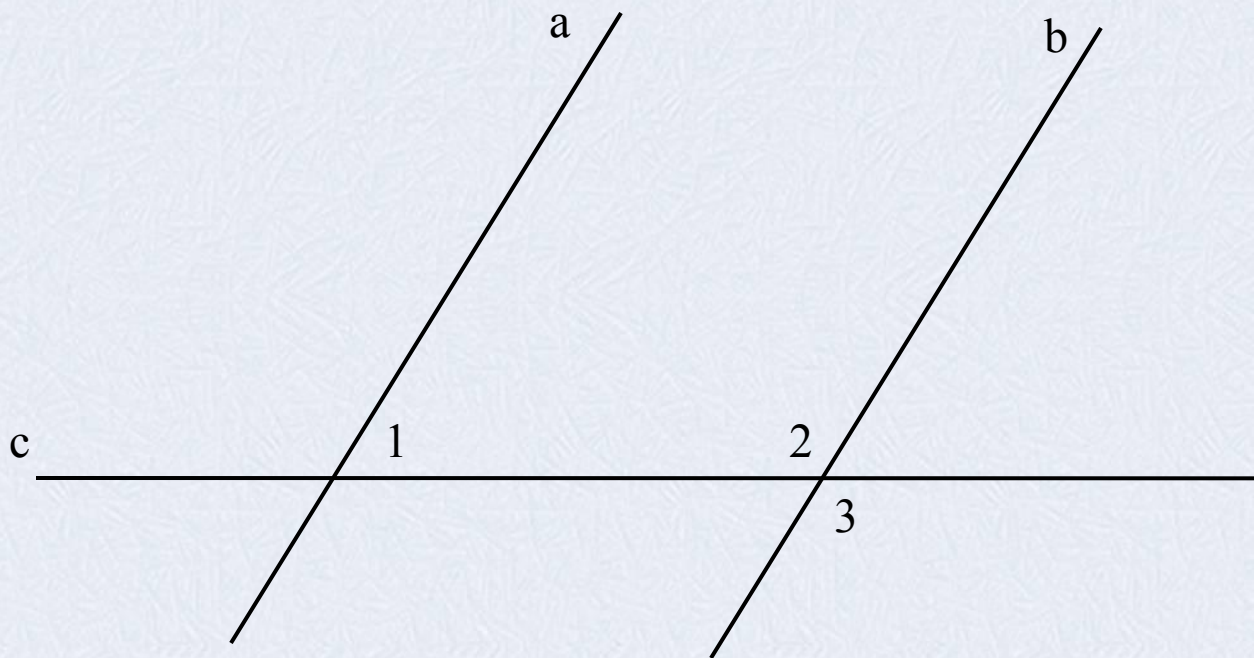

Дано:  $x \parallel y$ ;  $\angle 1 + \angle 2 = 100^\circ$ .  
Найти:  $\angle 3$ .

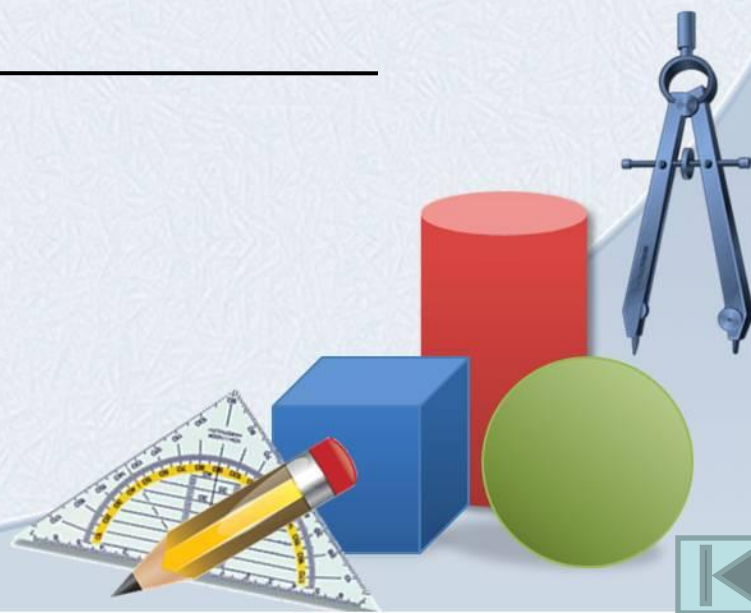
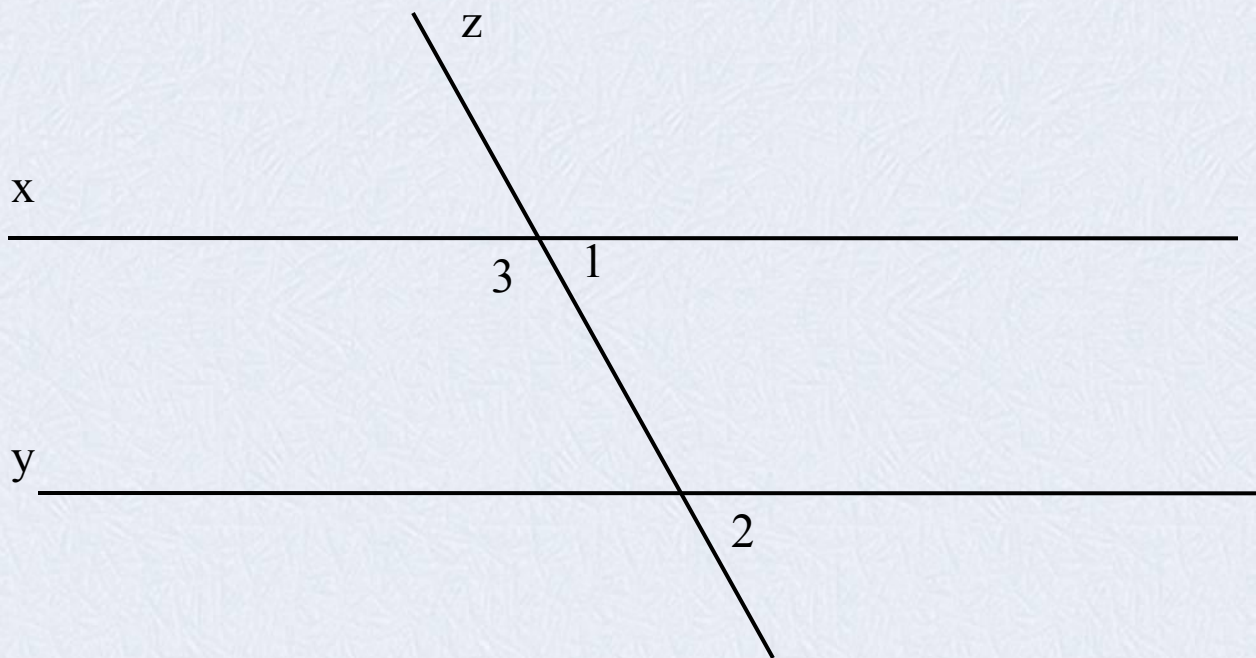

Дано:  $q \parallel z$ ;  $\angle 1 : \angle 2 = 2 : 7$ .

Найти:  $\angle 3$ .

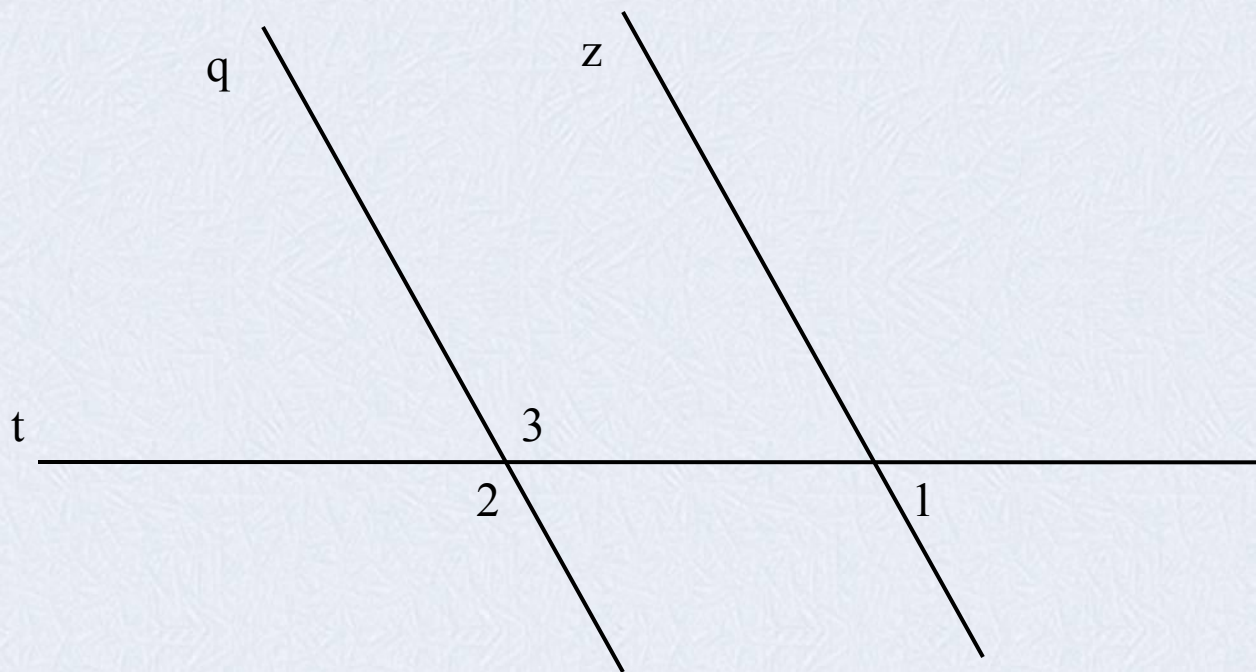

Дано:  $m \parallel t$ ;  $\angle 2$  на  $90^\circ$  больше  $\angle 1$ .  
Найти:  $\angle 3$ .

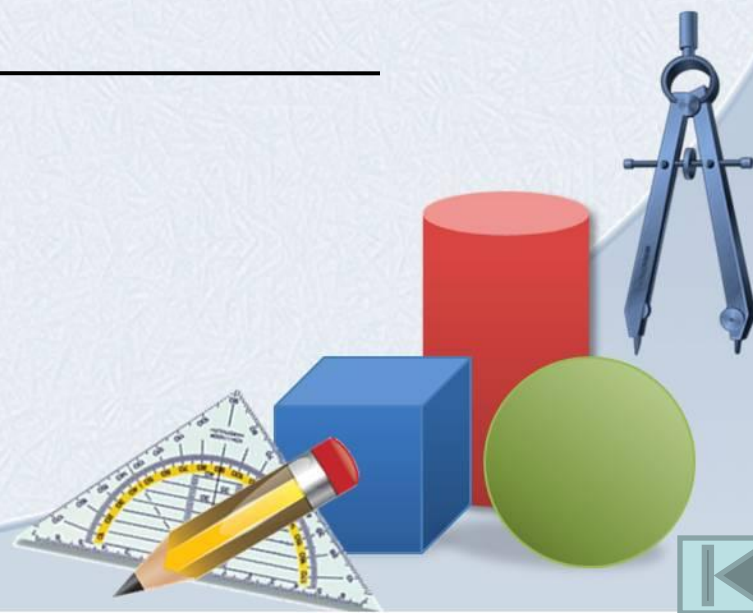
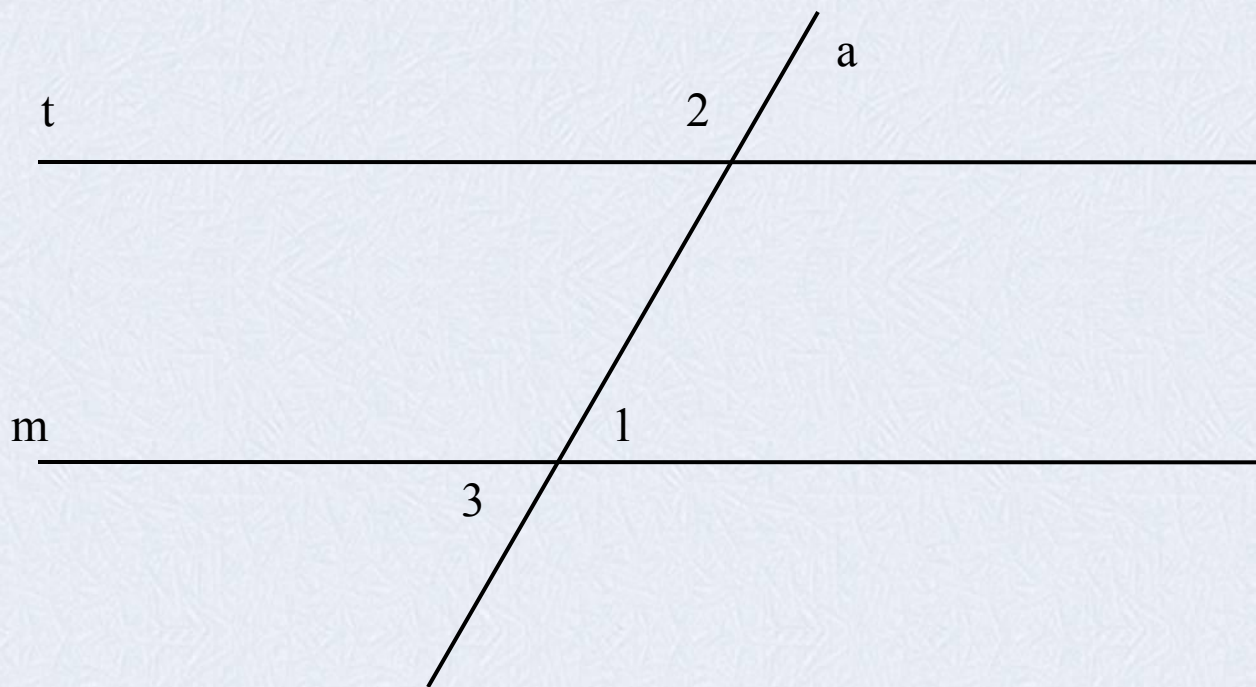



Дано:  $a \parallel b$ ;  
Найти:  $x$  и  $y$ .

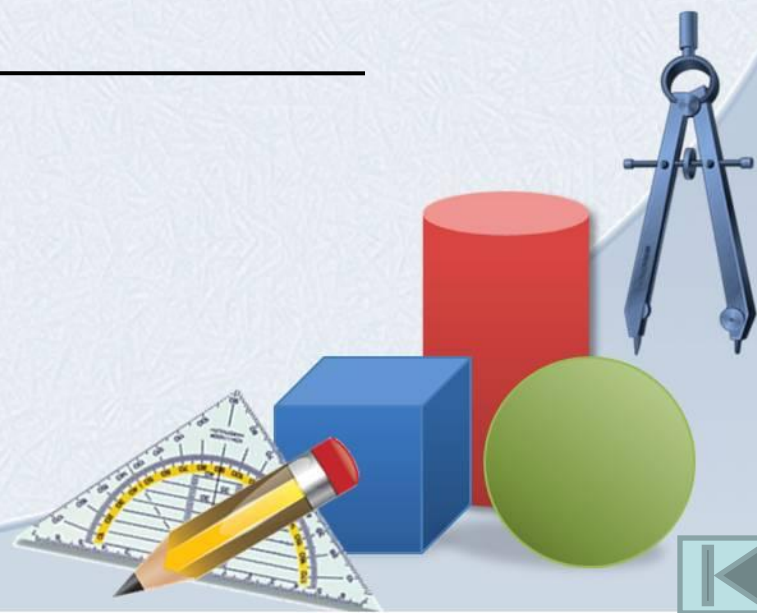
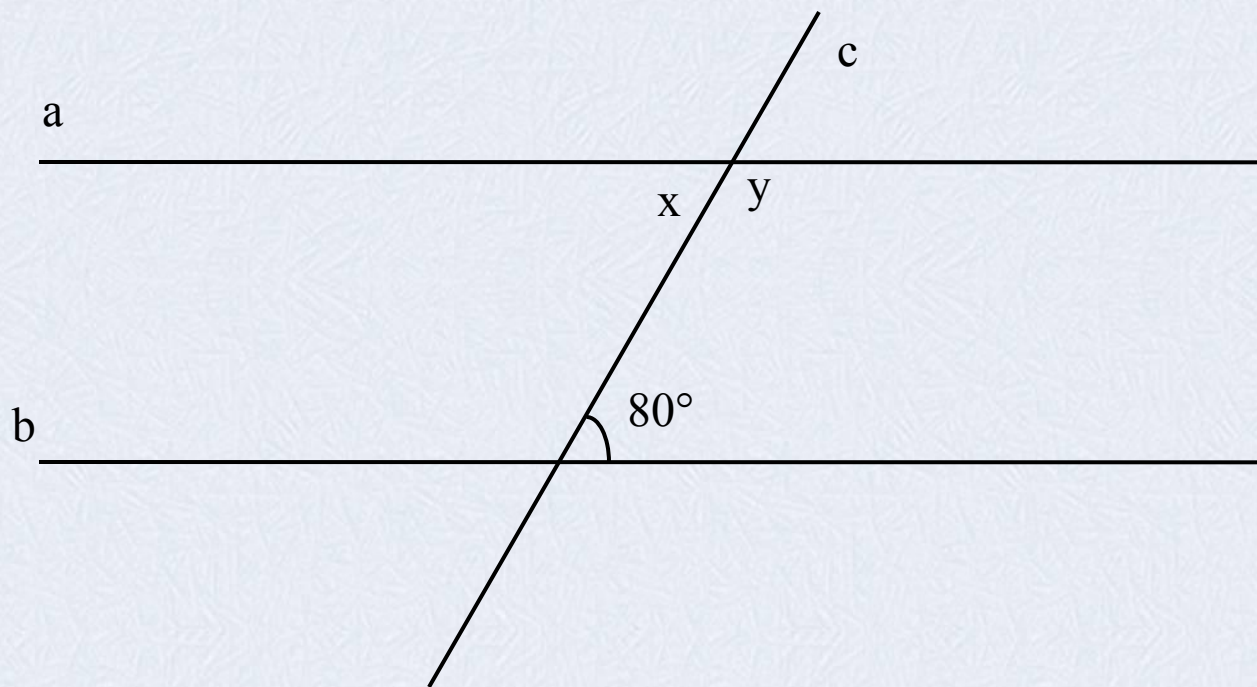

Найти:  $x$ .

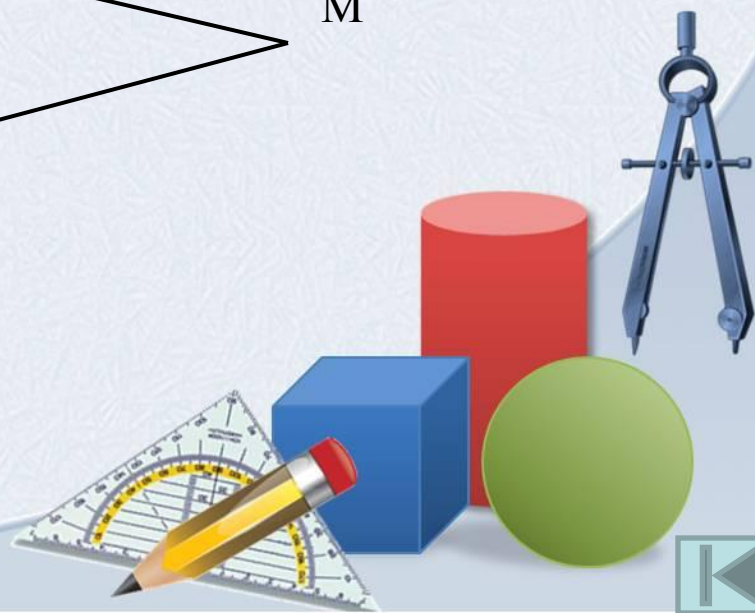
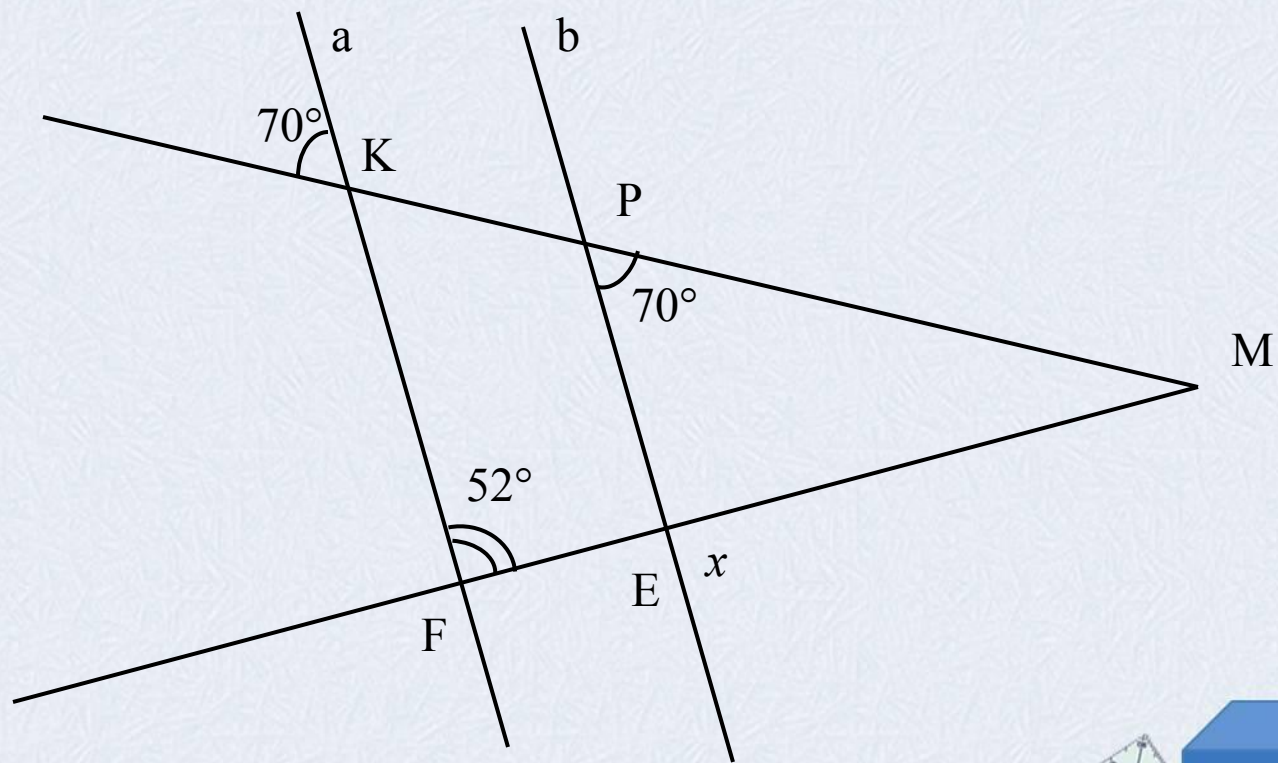

Найти:  $x$  и  $y$ .

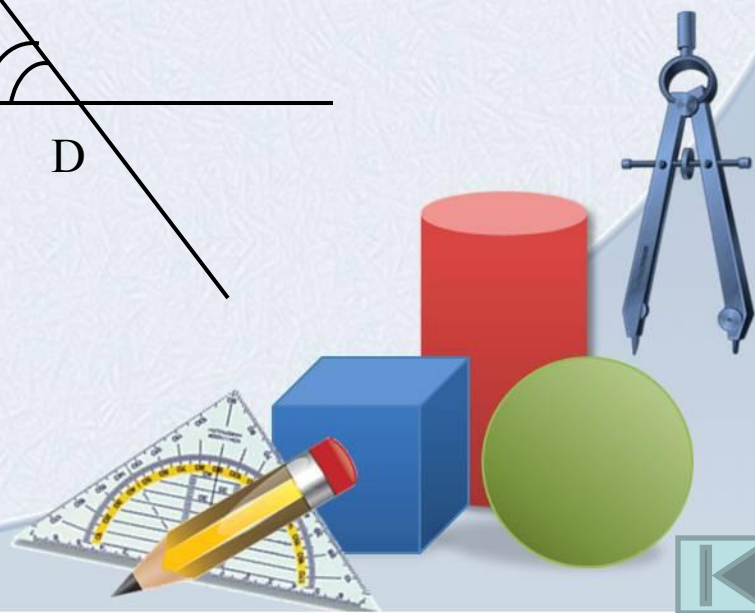
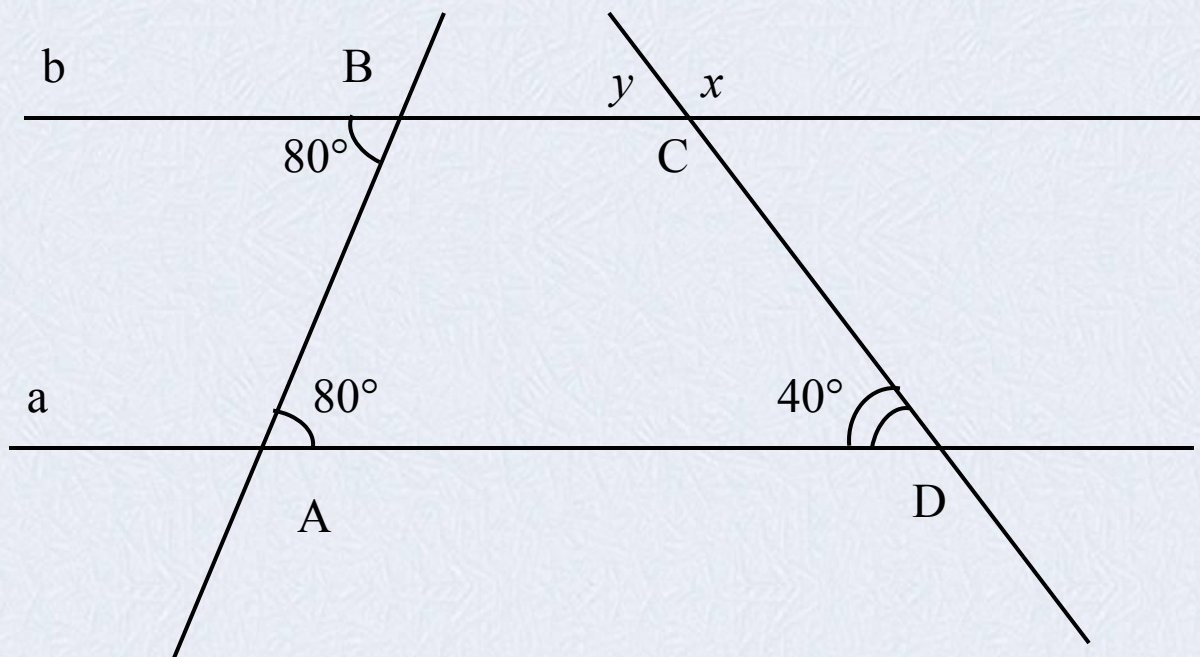

Найти:  $x$ .

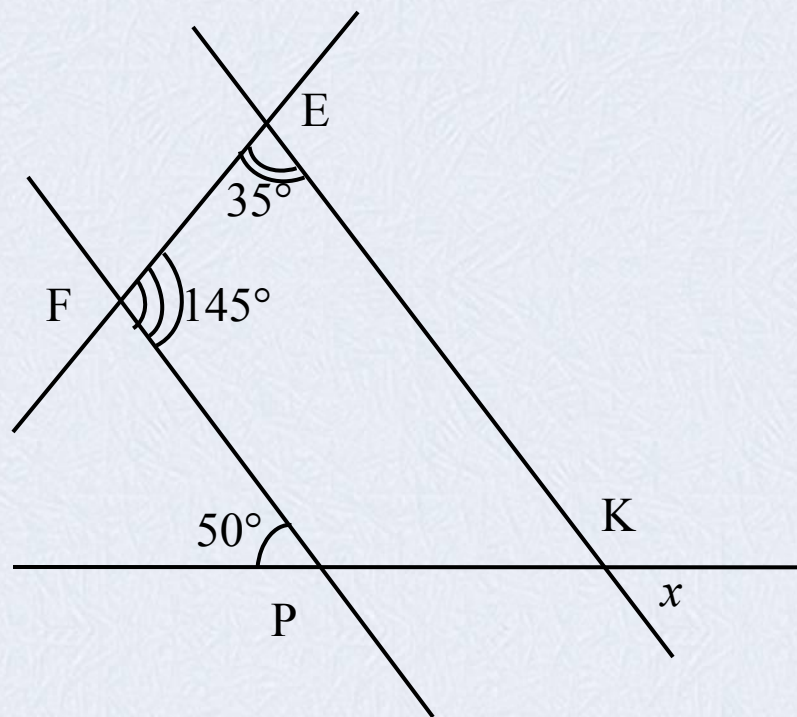

Дано:  $\angle ABE = \angle CBE$

Найти:  $x$ .

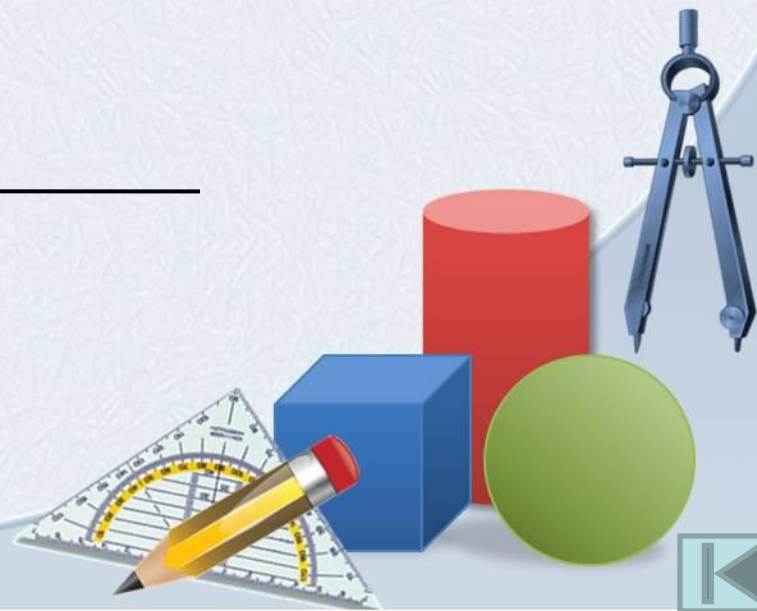
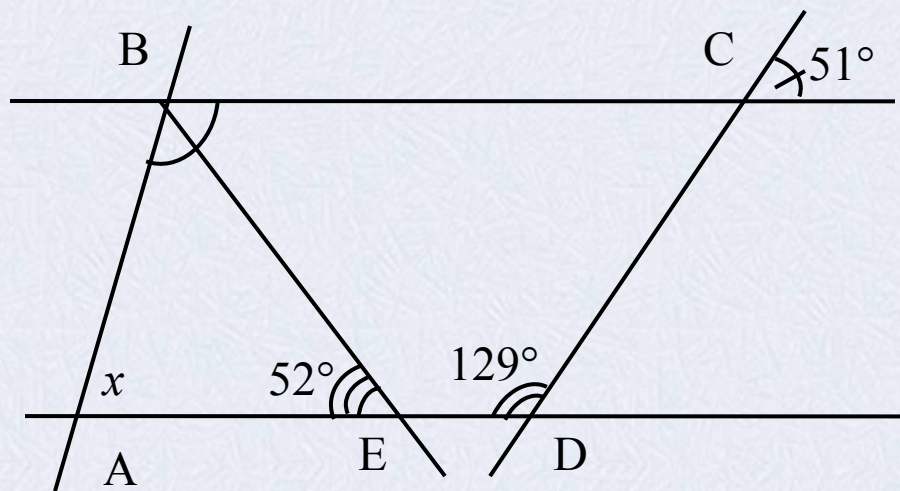

Найти:  $x$ .

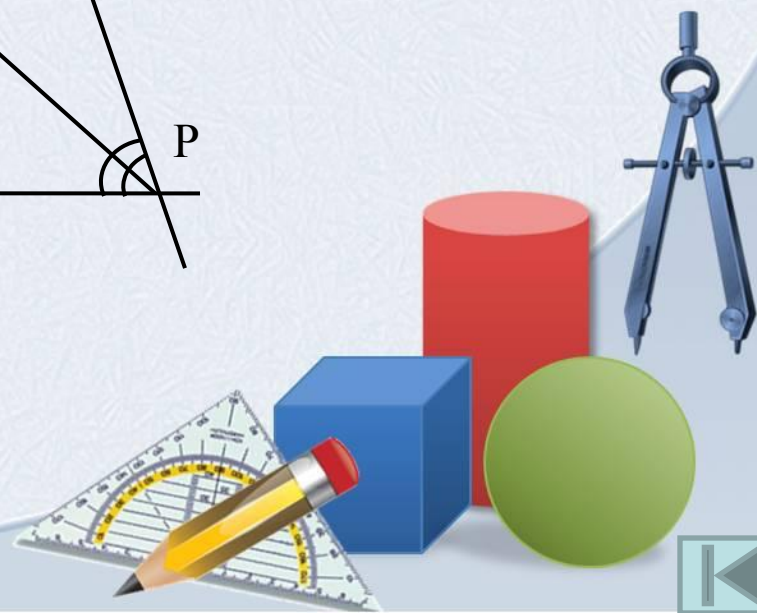
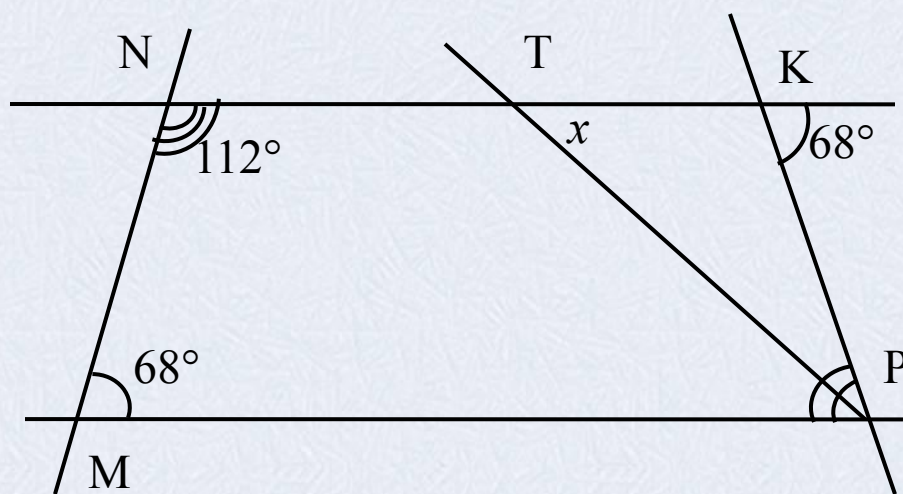

Дано:  $AB \parallel DE$ .

Доказать:  $\angle 1 + \angle 2 = \angle 3$

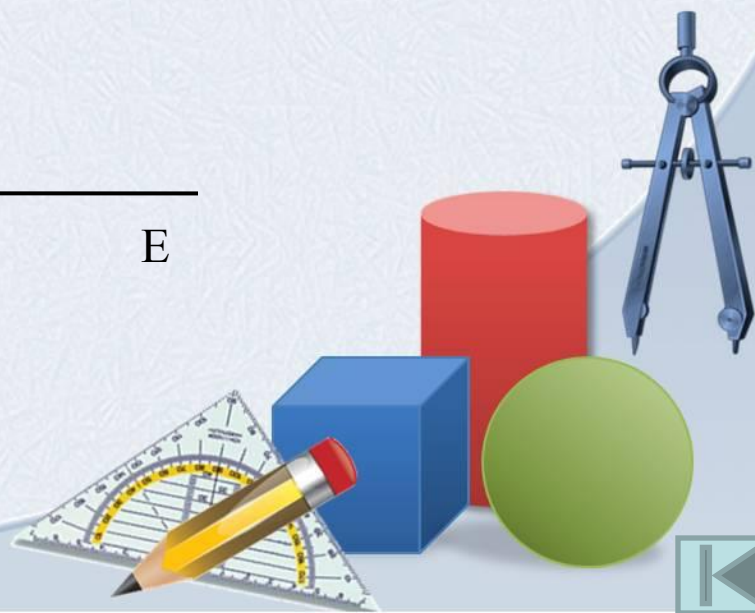
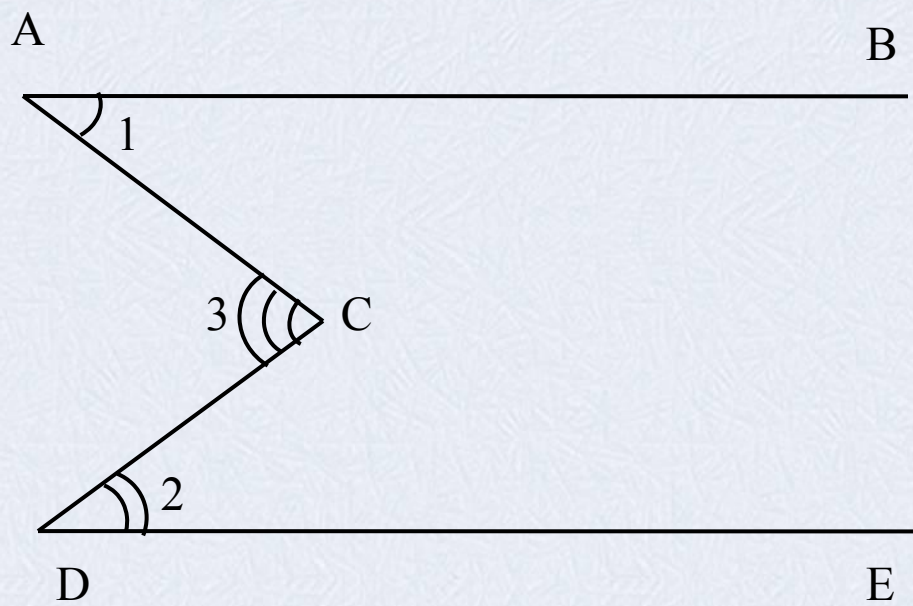

Дано:  $a \parallel b$

Доказать:  $\angle MOE = 90^\circ$

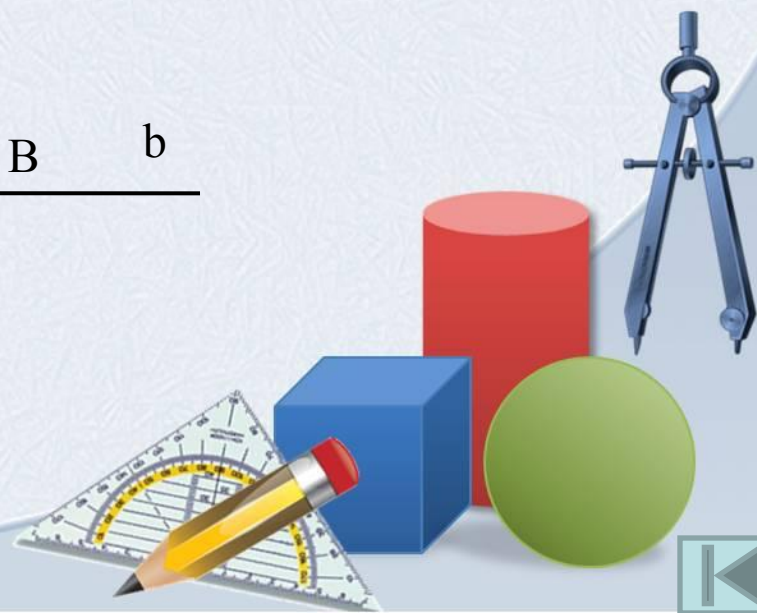
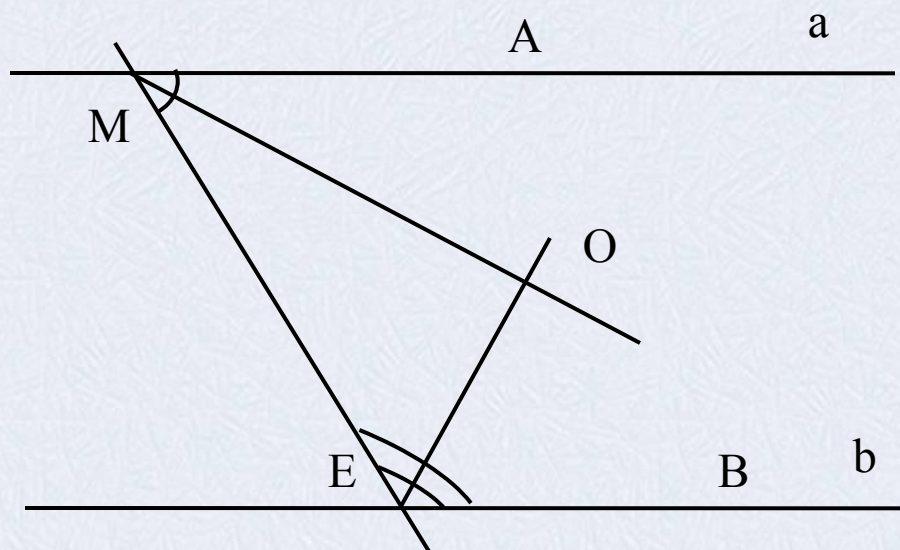



## Интернет-ресурсы

Циркуль: <http://www.daviddarling.info/images/compasses.jpg>

Карандаш:

<http://www.proshkolu.ru/content/media/pic/std/3000000/2240000/2239093-7acd9447b354cc7e.gif>

Угольник-транспортир:

[http://p.alejka.pl/i2/p\\_new/25/38/duza-ekierka-geometryczna-z-uchwytem-rottring-14-cm\\_0\\_b.jpg](http://p.alejka.pl/i2/p_new/25/38/duza-ekierka-geometryczna-z-uchwytem-rottring-14-cm_0_b.jpg)

Фон «тетрадная клетка»:

<http://radikal.ua/data/upload/49112/4efc3/3bd0a3d6bb.jpg>

## Список литературы

Рабинович Е.М. Задачи и упражнения на готовых чертежах. 7-9 классы. Геометрия. – М.: Илекса, Харьков: Гимназия, 2003. – 56 с.

Гаврилова Н.Ф. Поурочные разработки по геометрии: 7 класс. – М.: ВАКО, 2007.- 304 с.

## Шаблон презентации

*Ранько Елена Алексеевна*  
*учитель начальных классов*

*МАОУ лицей №21*

*г. Иваново*

*Сайт: <http://pedsovet.su/>*

