



SENFENG

Cutting | Cladding | Cleaning | Welding | Bending | Automation

SF3015M

Technical Solutions

SENFENG

Contents

I. Product introduction	02	IX.5 Star Service	20
II. Technical Parameter	03	X. Customer Testimonials	22
III. Configuration	05	XI. Trade show	23
IV. Main Features	06	XII. Company Strength	24
V. Cutting Capability and Application	11	XIII. Product Line	25
VI. Cost	16	XIV. Global Layout	29
VII. Bed body processing process	17	XV. Core Technology	30
VIII. Product			

I. Product introduction

SF3015M

Metal tube and plate laser cutter



- **SF3015M** metal sheet and pipe laser cutting machine is equipped with fiber laser power from 1KW to 3KW.
- Optional **3 meters** and **6 meters** for pipe cutting.
- It is an open type machine with single table, is able to cut both sheet metal and metal tube. **One machine, double function, affordable price.**

II. Technical Parameter

Item	Parameter				
	1kw	1.5kw	2kw	3kw	4kw
Work Area	3050*1530mm/9.84*4.92ft				
X-axis Travel	1530mm/5ft				
Y-axis Travel	3050mm/10ft				
Z-axis Travel	320mm/0.72ft				
Pipe length	500-6000mm				
Pipe diameters	20-220mm				
Positioning accuracy	±0.05mm				
Repeated positioning	±0.02mm				
Maximum speed	80m/min				
Maximum acceleration	0.8G				
Machine Total weight(KG)	3530	3550	3800	4100	4338
Table maximum load(KG)	700	700	700	700	700
Outline size (mm)	4626*3890*2000mm				
Power parameters	Three-phase AC380V 50Hz				
Protection Level of Total Power Supply	IP54				

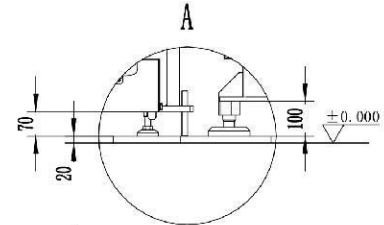
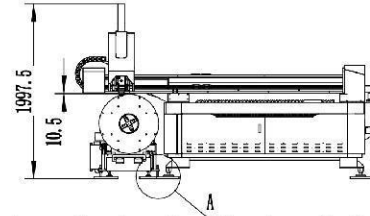
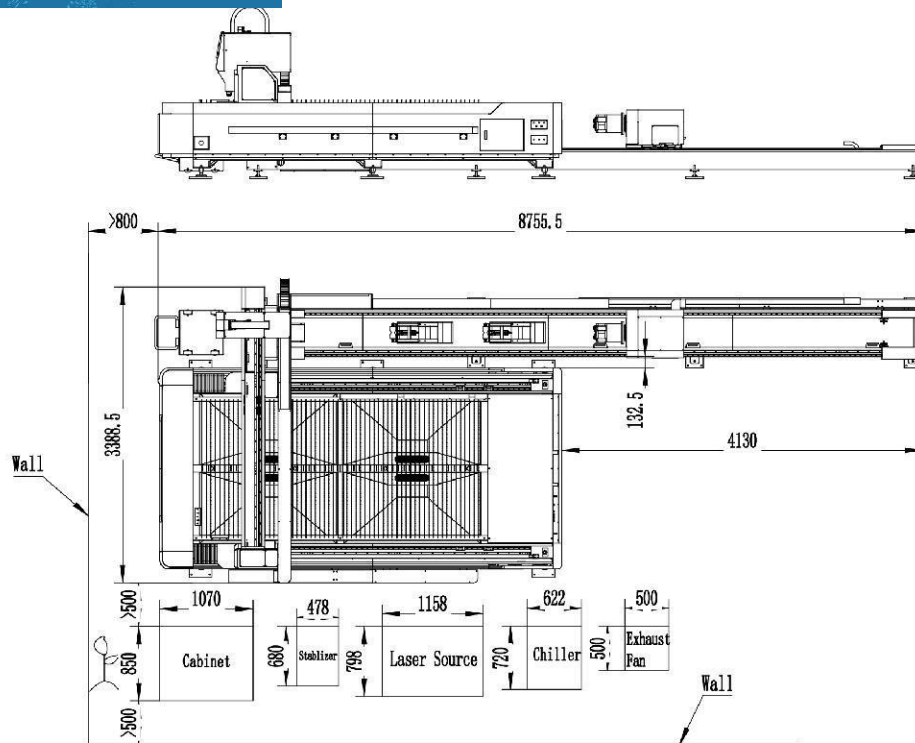

Laser Cutting Machine Installation Instruction:

1. Prepare base anchor for 14 pieces, dimensions like this:
2. To fix the base anchor with expansion anchor bolt, expansion anchor bolt size M12*100, 56 pieces;
3. After flattening the machine bed, you need to fix the machine bed with bolt, bolt size M16*130, welding bolt with right place of base anchor;
4. Adjust the support, make the machine bed flat, tight the bolt;
5. Pls make sure the floor is hard enough to bear 5T/m².

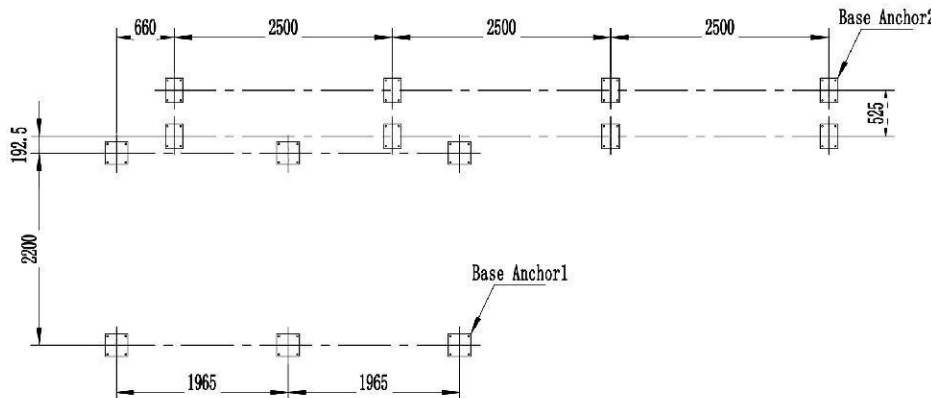
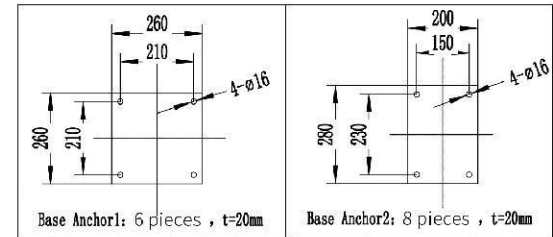

Installation material (Prepared by customer)		
Expansion Bolt	M12×100	56
Base Anchor2	see figure	8
Base Anchor1	see figure	6
Name	Specification	Quantity

III. Configuration

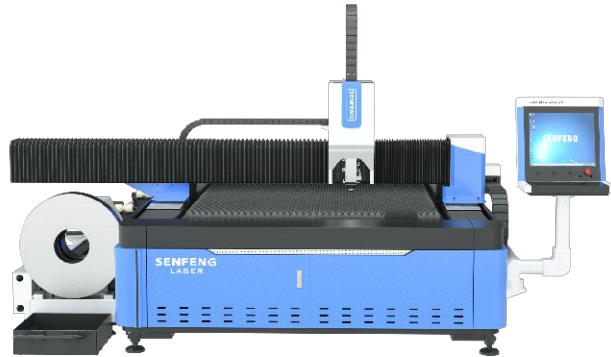

NAME	NO.	BRAND
Fiber laser	1 set	Raycus
Laser head	1 set	SENFENG
Transmission	4 set	LAPPING/SENFENG
Machine bed accessories	1 set	SENFENG
Motor reducer	6 set	EREFAT
Electrical and pneumatic	1 set	SIEMENSSMC/AIRTAC
Server motor and driver	7 set	DELTA/SCHNEIDER
Water cooling	1 set	HANLI
Control system	1 set	FSCUT 3000

IV. Main Features

High strength machine bed



- High-strength machine tool, adopting 600°C high temperature annealing treatment, with integrated machine rigidity;
- The overall mechanical structure has small deformation and low vibration, ensuring cutting accuracy.

Strong Aviation Aluminum Beam



- The use of aviation-grade high-strength aluminum alloy beams, light weight, low inertia;
- Built-in triangular reinforced structure, strong rigidity, good shock absorption;
- Rough machining after annealing to eliminate internal stress, and fine machining after secondary vibration aging treatment to ensure Improve the overall strength and stability of the beam.

Automatic gas distribution device for auxiliary gas

- SF3015M CNC laser cutting machine is equipped with three different gases, namely air, nitrogen (300psi) and oxygen, each of which can be individually controlled for its flow and pressure.
- The equipment software terminal is configured to select the auxiliary gas function automatically. The type and pressure of the auxiliary gas can be automatically set and selected through the numerical control program, without manual operation.
- The pressure of compressed air and oxygen can be adjusted between 150 m Bar and 6 Bar, and the pressure of nitrogen can be adjusted between 150 m Bar and 25 Bar.
- In addition, the actual air pressure at the exit of the cutting head can also be easily read and displayed on the panel in real time.

Automatic Focusing Fiber Laser Cutting Head



- This kind laser head has a strong advantage on medium power large format fiber laser cutting application.
- Completely sealed internal structure of laser head can avoid optical part polluted by dust.
- Two point centering adjustment of laser head; the focus adjusting take imported motor driving and has great improvement in perforation.
- Protective lens take more convenient replacement drawer installation way.
- Can be equipped with various kind of QBH connectors laser machine.

Raycus Laser Device



- It has the advantages of high electro-optical conversion efficiency (>40%), good beam quality, high energy density, wide modulation frequency, strong reliability, long life, and maintenance-free operation.
- It can be widely used in welding, precision cutting, cladding, and surface treatment, 3D printing and other fields.

FSCUT3000S medium and low power laser cutting system

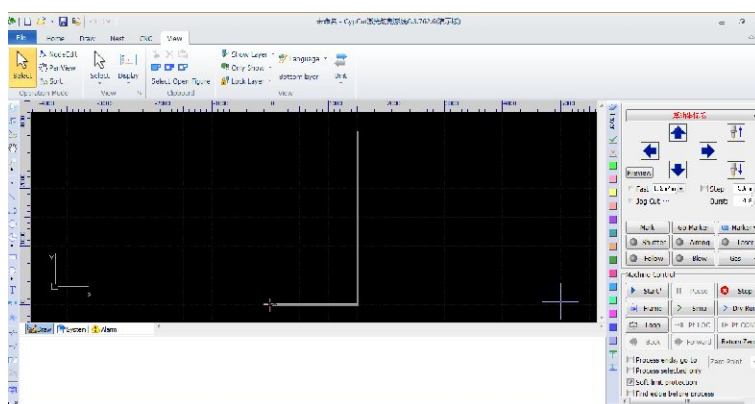

- The FSCUT3000S mid-power laser cutting system is a full-featured open-loop control system specially launched for the pipe processing industry. Easy debugging, safe production, rich functions, excellent performance, etc.;
- supports and provides debugging, personalized, automated, and information solutions, can realize memory cache, has a powerful cutting process database, and cuts a variety of different thicknesses and different plates, fast operation and efficient cutting

Transmission System

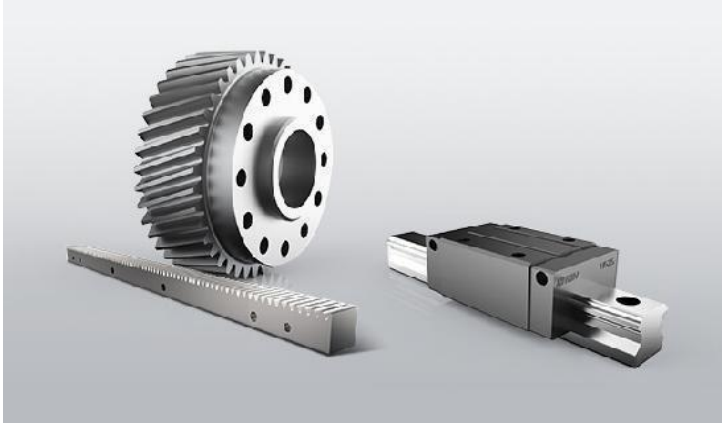

- High precision, long life, can provide rigorous support for quenching helical gears and grinding helical gears, so that the load drive structure is compact, can effectively reduce the driving torque.

Circuit board



Water Cooling System



- Large cooling capacity, stable performance, trouble-free, clean water quality, good heat exchange effect with fiber laser, and linkage signal to protect the laser.

Height Controller



- High precision, long life, can provide rigorous support for quenching helical gears and grinding helical gears, so that the load drive structure is compact, can effectively reduce the driving torque.

Automatic Lubrication System



- Lubricating the guide rails of X axis.
- Y axis, Z axis automatically, which could reduce maintenance cost and save time significantly.
- Oiling time can be adjusted.
- According to processing.
- Amount, which is more humanized.

V.Cutting Capability and Application

Cutting Materials

Carbon steel,
stainless steel,
aluminum alloy,
brass, copper,
galvanized sheet,
silicon steel
sheet, electrolytic
sheet, titanium
alloy, manganese
alloy, etc.

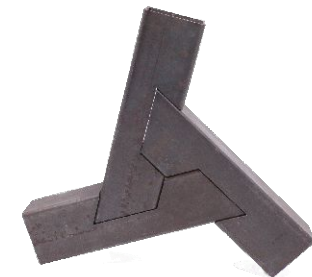

Application Industry



Sheet Metal Fabrication



Manufacturing industry



Refrigeration equipment



Mechanical processing

SENFENG

Cutting | Cladding | Cleaning | Welding | Bending | Automation



Elevator manufacturing



Advertising industry



Food machinery

Cutting Capacity



Cutting Parameters

Material	Thickness (MM)	1KW	1.5kw	2KW	3KW	4KW
		Cutting Speed (m/min) (gas)	Cutting Speed (m/min) (gas)	Cutting Speed (m/min) (gas)	Cutting Speed (m/min) (gas)	Cutting Speed (m/min) (gas)
Stainless Steel	1	18-20 (N2)	25-30 (N2)	30-35 (N2)	30-45 (N2)	45-55 (N2)
	2	6.0-8.0 (N2)	8.0-10 (N2)	10-13 (N2)	20-25 (N2)	25-30 (N2)
	3	2.5-3.2 (N2)	4.5-5.0 (N2)	5.0-6.5 (N2)	8.0-10 (N2)	8.5-12 (N2)
	4	1.5-2.0 (N2)	2.5-3.3 (N2)	4.0-5.0 (N2)	6.0-9.0 (N2)	6.0-8.3 (N2)
	5	0.8-1.0 (N2)	1.0-1.4 (N2)	2.0-2.3 (N2)		4.0-5.0 (N2)
	6		0.8-1.0 (N2)	1.5-2.0 (N2)	3.0-3.5 (N2)	2.0-3.0 (N2)
	8			0.8-1.2 (N2)	1.0-1.5 (N2)	1.2-1.6 (N2)
	10				0.6-1.0 (N2)	0.8-1.2 (N2)
	12				0.4-0.6 (N2)	45-55 (N2)
Carbon Steel	1	15-18 (N2)	15-20 (O2)	25-35 (N2)	30-40 (N2/Air)	25-40(N2/Air)
	2	5.0-7.0 (O2)	6.2-8.5 (O2)	9.0-12 (N2)	20-23 (N2/Air)	15-20(N2/Air)
	3	3.5-4.0 (O2)	4.5-5.0 (O2)	3.5-4.5 (O2)	3.5-4.5 (O2)	7.0-9.0(N2/Air)
	4	2.0-3.5 (O2)	3.5-4.0 (O2)	3.0-3.5 (O2)		3.5-4.5(O2)
	5	1.8-2.5 (O2)				2.8-3.3(O2)
	6	1.5-2.2 (O2)	2.0-2.5 (O2)	2.0-2.5 (O2)	2.8-3.5 (O2)	2.2-3.0(O2)
	8	1.0-1.5 (O2)	1.4-1.8 (O2)	1.3-1.7 (O2)	2.3-2.7 (O2)	2.0-2.3(O2)
	10	0.8-1.0 (O2)	1.0-1.3 (O2)	1.0-1.6 (O2)	1.8-2.1 (O2)	1.5-1.7(O2)
	12	0.6-0.8 (O2)	0.8-1.2 (O2)	0.8-1.2 (O2)	1.4-1.6 (O2)	1.0-1.4(O2)
	14		0.6-0.8 (O2)	0.8-1.0 (O2)	1.0-1.3 (O2)	1.0-1.2(O2)
	16		0.5-0.6 (O2)	0.7-1.0 (O2)	0.6-1.0 (O2)	0.6-0.8(O2)
	18			0.5-0.6 (O2)		0.4-0.6(O2)
	20				0.5-0.7 (O2)	25-40(O2)
25					15-20(O2)	

Cutting Parameters

Material	Thickness (MM)	1KW	1.5kw	2KW	3KW	4KW
		Cutting Speed (m/min) (gas)	Cutting Speed (m/min) (gas)	Cutting Speed (m/min) (gas)	Cutting Speed (m/min) (gas)	Cutting Speed (m/min) (gas)
Brass	1	10.0-12.0 (N2)	12.0-13.0 (N2)	15-25 (N2)	25-35 (N2)	30-35(N2)
	2	4.5-5.0 (N2)	5.0-6.0 (N2)	8.0-11 (N2)	12-18 (N2)	15-18(N2)
	3	1.0-1.2 (N2)	1.5-2.0 (N2)	3.0-4.5 (N2)	6.0-8.0 (N2)	8.0-12(N2)
	4			1.3-1.7 (N2)	3.0-4.0 (N2)	3.0-4.0(N2)
	5					2.0-2.5(N2)
	6			0.6-0.8 (N2)	0.8-1.0 (N2)	1.0-1.6(N2)
	8					30-35(N2)
	10	13-17 (N2)	15-21 (N2)	25-30 (N2)	30-35 (N2)	35-40(N2)
Aluminum	2	4.8-5.2 (N2)	6.0-9.0 (N2)	10-15 (N2)	14-20 (N2)	20-25(N2)
	3	1.2-1.8 (N2)	2.0-4.0 (N2)	4.0-5.0 (N2)	8.0-10 (N2)	8.0-13(N2)
	4		1.3-1.7 (N2)	2.0-2.5 (N2)	5.0-7.5 (N2)	6.0-7.5(N2)
	5				3.0-3.5(N2)	3.5-4.0(N2)
	6		0.6-0.9 (N2)	0.6-1.0 (N2)	1.2-1.5 (N2)	2.0-2.5(N2)
	8				0.7-1.0 (N2)	1.0-1.2(N2)
	10					0.4--0.6(N2)
	12					35-40(N2)

VI.Cos

Mode		1kw			1.5kw			2kw			3kw			4kw		
		Air compressor	O2	N2	Air compressor	O2	N2	Air compressor	O2	N2	Air compressor	O2	N2	Air compressor	O2	N2
Electricity consumption	laser device	4kw			6kw			7kw			10.5kw			12.5KW		
	Chiller power	2.6kw			3.3kw			3.6kw			7.37kw			6KW		
	Air compressor power	11kw	/	/	11kw	/	/	11kw	/	/	11kw	/	/	15KW	/	/
Consumable parts	Main body	10kw														
	Dust removal equipment	1.5kw														
	RMB/H	0.5														
Gas Consumption	USD/H	0.076 (1USD ≈ 6.5413RMB)														
	RMB/H	0	4	60	0	4	60	0	4	60	0	4	60	0.5	4.5	60.5
	USD/H	0	0.61	9.17	0	0.61	9.17	0	0.61	9.17	0	0.61	9.17	0.07	0.698	9.38
Total Power (KW)		29.1	18.1	18.1	31.8	20.8	20.8	33.1	22.1	22.1	40.37	29.37	29.37	45	30	25.8
Total Power Consumption(KW/H)		17.4	10.8	10.8	19.1	12.4	12.4	19.9	13.3	13.3	24.2	17.62	17.62	27	18	15.5
Total Operation Cost1RMB/kwh		17.9	15.3	71.3	19.6	16.9	72.9	20.4	17.8	73.8	24.7	22.1	78.1	27.5	22.5	78.5
		2.7	2.3	10.9	3	2.6	11.1	3.1	2.7	11.3	3.8	3.4	11.9	4.26	3.49	12.17

VII. Bed body processing process



01

Metal Cutting

The raw materials for machine bed welding are all cut by laser.



02

Machine Bed Welding

Machine bed welding adapts mixed gas (80% argon 20% carbon dioxide) which can better ensure the formation, firmness and smoothness of the welding, to improve the overall quality of the bed.



03

Natural Aging Treatment

The bed will be placed outdoors for 1 to 6 months after welding, under the overload caused by thermal stress, the residual stress is relaxed and the dimensional accuracy is stabilized.



04

Heat Treatment

It takes about 24 hours for the overall heat treatment of a bed, achieving the purpose of eliminating residual stress, stabilizing size, reducing deformation and cracks, making our bed more durable and longer in service life.





05

Shot Blasting

We use shot blasting to remove the excess rust layer, oxide skin and oil stains on the bed, which can greatly improve the cleaning efficiency and strengthen the surface quality of the bed.



06

Spra

We adopt automatic process, which is safe and stable, and efficient; the high temperature paint baking room can heat up quickly, dry quickly, and make the surface of the bed smooth and without impurities.



07

Machinin

The final finishing of the bed and beam can completely eliminate the stress caused by welding and processing, ensuring the stability and high precision of the bed, which will run for a long time without deformation.



08

Accuracy

We use CMM and other instruments to test the accuracy of the bed.



VIII. Product Certification

Senfeng fiber laser machines have passed CE from TÜV,ROHS,FDA,ETL certificates, which is in line with European and American standards.



IX .5 Star Service



High efficiency

24 hours a day (mainly for international), 7 days a week, 365 days a year at any time to receive repair calls;
Within 10 minutes, technical engineers will consult, fix maintenance plan in one hour, and send engineers in one working day.



After-sale service

The seller provides one time free installation and training in buyer's factory. Seller pays for the airplane tickets and salary for engineers, buyer should provide accommodation and food to engineers.

The seller will provide technical guide's e-mail, telephone, WeChat, WhatsApp and so on.

The seller should pay for the travel expense if local service needed within warranty time.



Warranty

The warranty of laser source is 2 years.

The warranty of the machine is 2 years (main spare parts), except for the consumable parts such as ceramic ring, focus lens, nozzle etc. Warranty counts from the date marked on the label of the laser source and machine.

Except the damage artificially, seller is responsible for offering the fittings free of charge during the warranty period.

Exceeding the warranty period, parts need to be repaired or changed, shall be paid.



Worry-free

Pre-sale service: theoretical + practical operation training, self-diagnosis training for common faults, guidance for quick repair of difficult faults, and warning of matters needing attention in use;

Regular service: regular maintenance reminder, regular door-to-door service, regular promotional activities;

Value-added services: equipment software and hardware upgrading services, financial leasing services, delayed warranty service.



Field Service

Our branches in United States, Germany, India, Pakistan, Serbia provide localized services and technical support for global customers.

Service Oriented and Customer First



X.Customer Testimonials



SENFENG
LASER



XI.Trade show



SENFENG
LASER



XII. Company Strength



About us

Senfeng Laser is a leading manufacturer engaged in the research, development, Production, sale and service of fiber laser cutters, fiber laser cleaning machine, laser marking machine, laser welding machine, 3D robot, press brake bending machine, metal sander, etc.



XIII.Product Line

Fully Enclosed Metal Sheet Cutter

SF3015H

Fourth Generation Metal Fiber Laser Cutter



SF1530G

Security Protective Fiber Laser Cutter



Automatic Laser Cutting Production Line



Metal Sheet Cutting Machine

SF3015G

Open Type Metal Sheet Laser Cutting Machine



SF20040R

Ultra Large Metal Laser Cutter

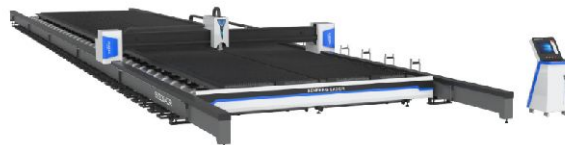

Plate And Tube Cutting Machine

SF3015HM

Full Protection Steel Sheet and Tube Laser Cutter



Tube Laser Cutting Machine

SF6020GT

Bevel Tube Laser Cutting Machine



SF6020TZ

Affordable metal tube laser cutter



SF12038HT

Ultra Heavy Four-chuck Tube Laser Cutting Machine

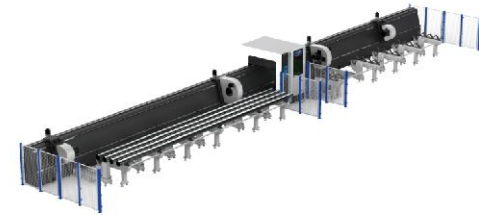

Coil Fed Laser Cutting System

SF1503CLH

Aluminum Coil-fed Laser Cutting Machine

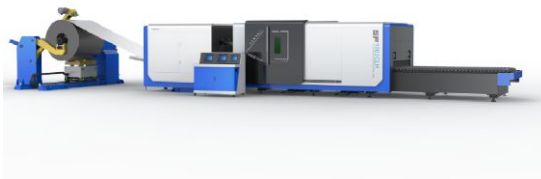

SF2014CH

Heavy-load coil laser cutting machine



SF1503CH

Coiled Fiber Laser cutting machine



Fiber Laser Welding Machine / Fiber Laser Cleaning Machine

SF1500HWM

Handheld Fiber Laser Welding Machine



SF200HC

Fiber Laser Cleaning Machine



SF1500HC

Portable laser cleaning machine



3D Robot

3D Robot Laser System



3D Robot Fiber Laser Cutting Machine



3D robot fiber laser welding machine



Laser Cladding Equipment

SFHS3050

Metal additive machine

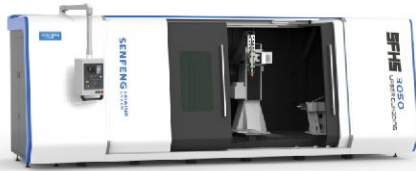

SFR6063

Robot Laser Cladding Machine



SFMR02

Mobile Robot Laser Cladding System



Metal sheet bending machine

BDE13032

CNC Bending Machine



BDC-1800

Servo Electric Press Brake



Wide Belt Sheet Metal Sander

SF1000SSD

Automatic Wide Belt Sheet Metal Sander



XIV.Global

Layout

Senfeng Laser to provide localized services and technical support for global customers.

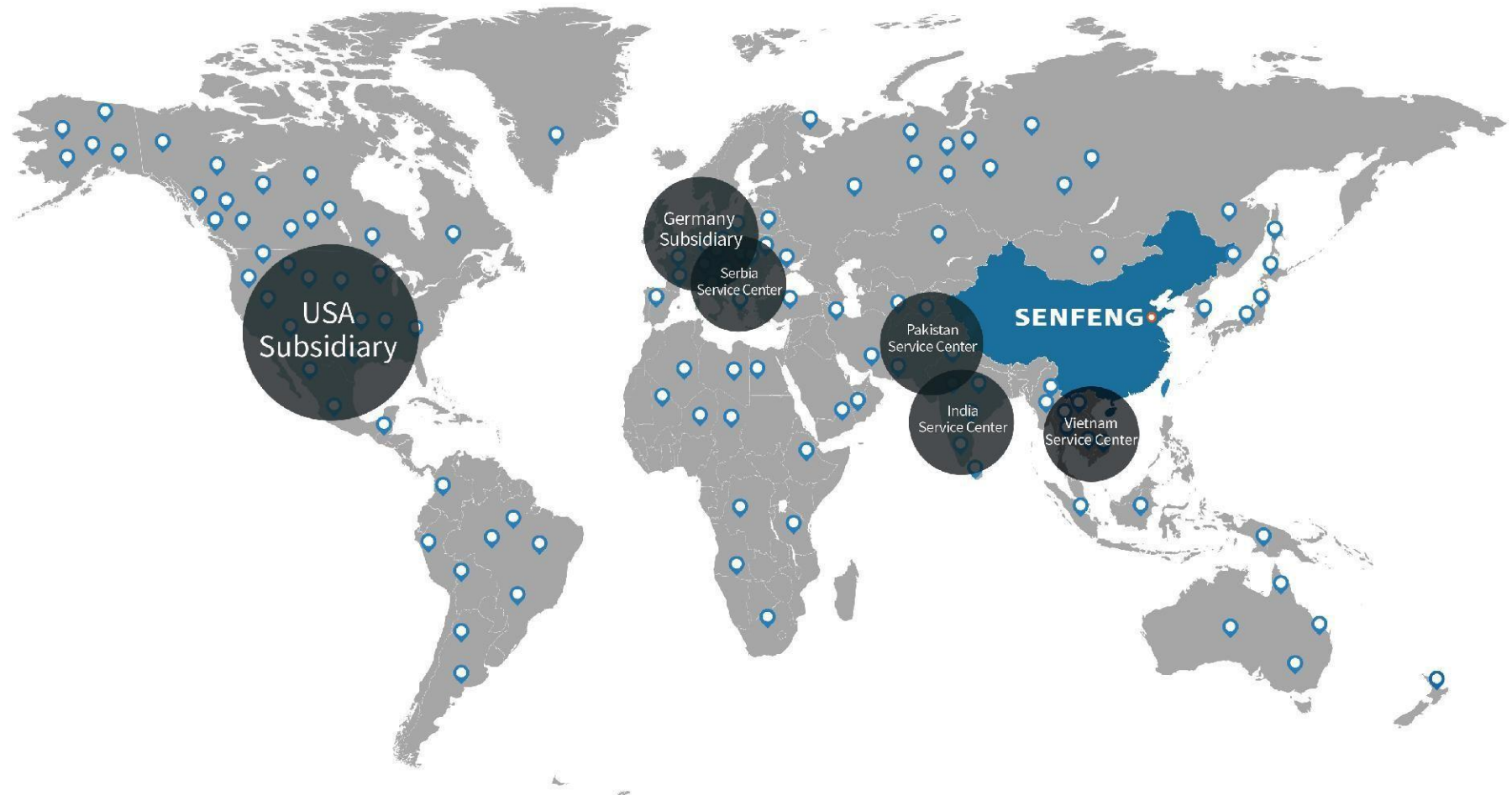

XV.Core Technology

Senfeng laser generators which are independently developed have been widely used in laser cutting, welding, cleaning, cladding additive and other fields



- **Auto Focus Operator** can set consequent focus adjustment by procedure, finishing quick piercing to thick plates and cutting different thickness plates automatically.
- **Water cooling** Focusing parts of laser cutting head with water cooling, reducing high temperature and flog by long time cutting.
- **Storm cut** Storm cut technology with ultra high power laser source, with SENFENG cutting technology, realizing high speed
- **Bright Cut Technology** Bright Cut Technology developed by SENFENG LASER can efficiently solve: too much burr, cutting surface not smoothly, difficult to cut high-reflect material etc.



More details about senfeng R&D, feel free to visit website: www.sfcnclaser.com