

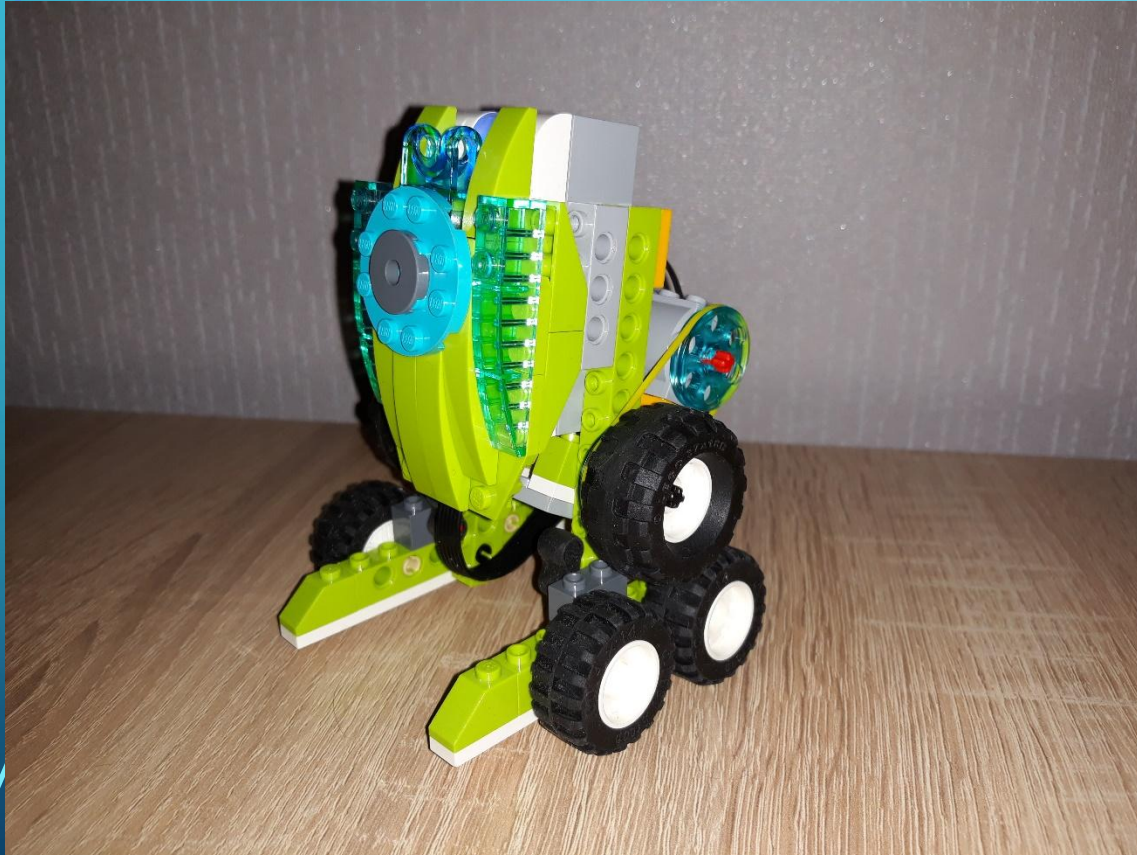

# ИНСТРУКЦИЯ ПО СБОРКЕ ДЛЯ НАБОРА WEDO 2.0

## «РОБОТ R2D2»

# WEDO 2.0 «РОБОТ R2D2»



# WEDO 2.0 «РОБОТ R2D2»

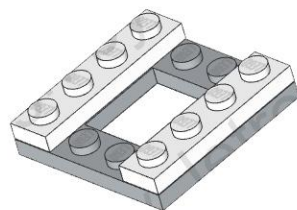
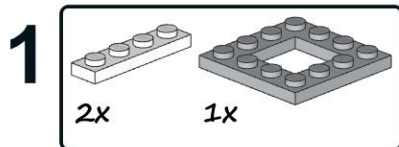

# WEDO 2.0 «РОБОТ R2D2»

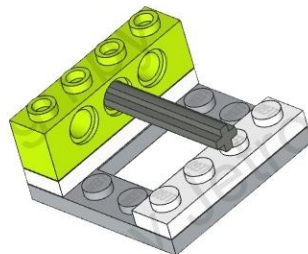
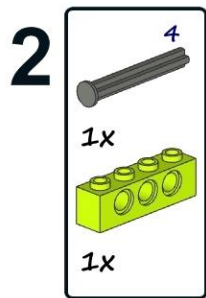

# WEDO 2.0 «РОБОТ R2D2»

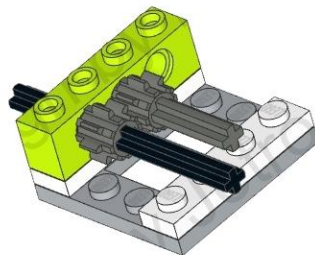

# WEDO 2.0 «РОБОТ R2D2»

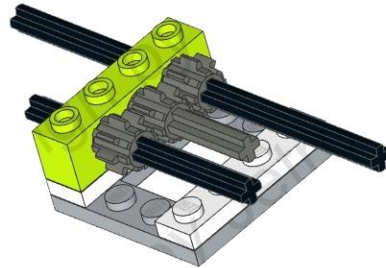
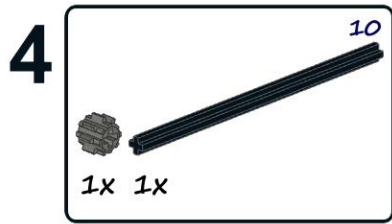

# WEDO 2.0 «РОБОТ R2D2»

5   
3x

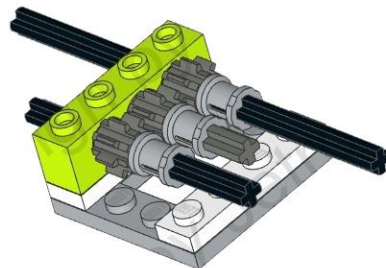

# WEDO 2.0 «РОБОТ R2D2»

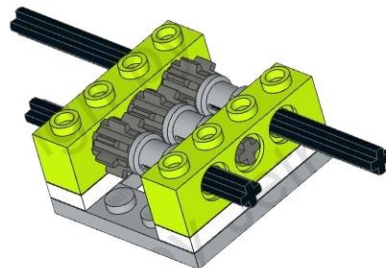
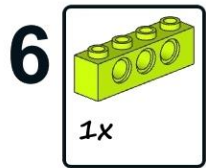

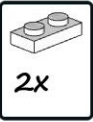

# WEDO 2.0 «РОБОТ R2D2»

7  2x

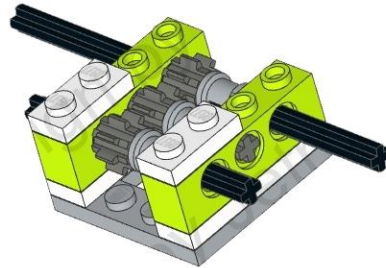

# WEDO 2.0 «РОБОТ R2D2»

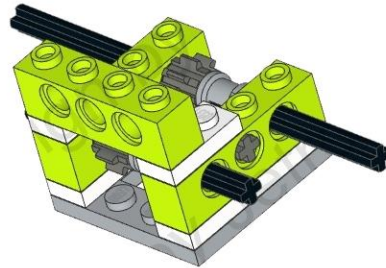
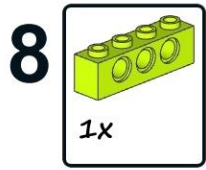

# WEDO 2.0 «РОБОТ R2D2»

9

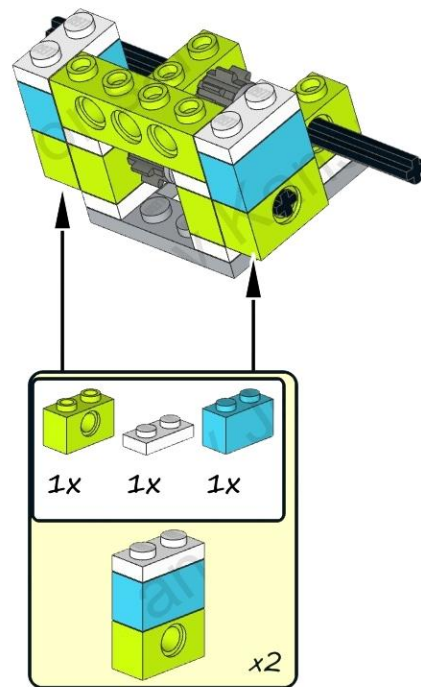

# WEDO 2.0 «РОБОТ R2D2»

10

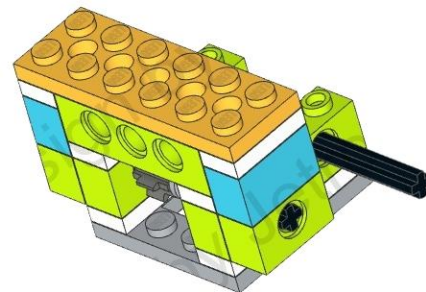
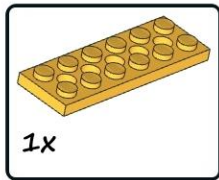

# WEDO 2.0 «РОБОТ R2D2»

11

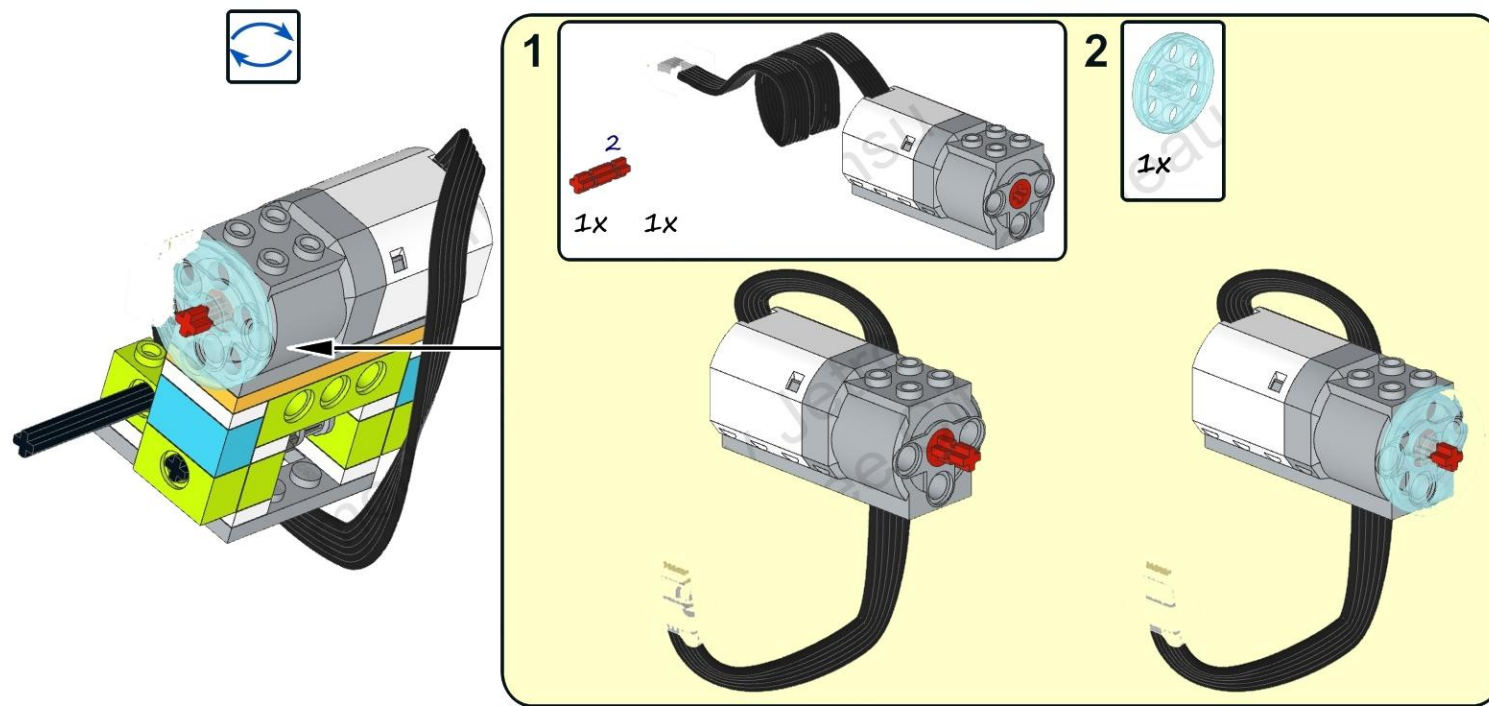

# WEDO 2.0 «РОБОТ R2D2»

12

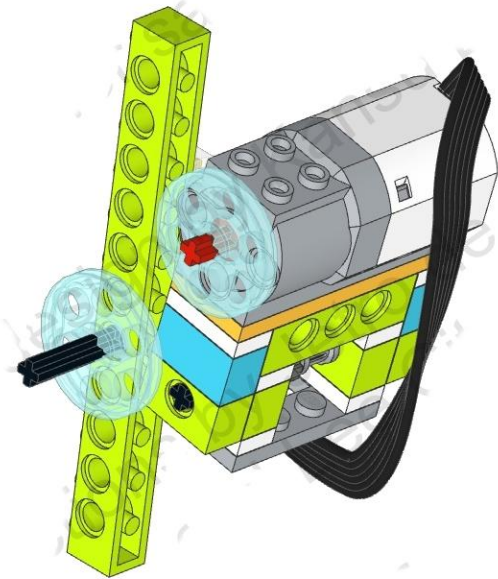
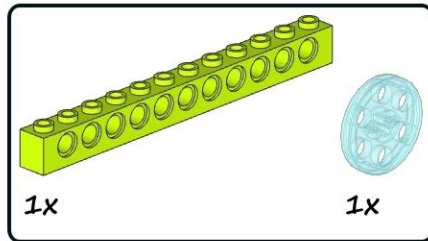

# WEDO 2.0 «РОБОТ R2D2»

13

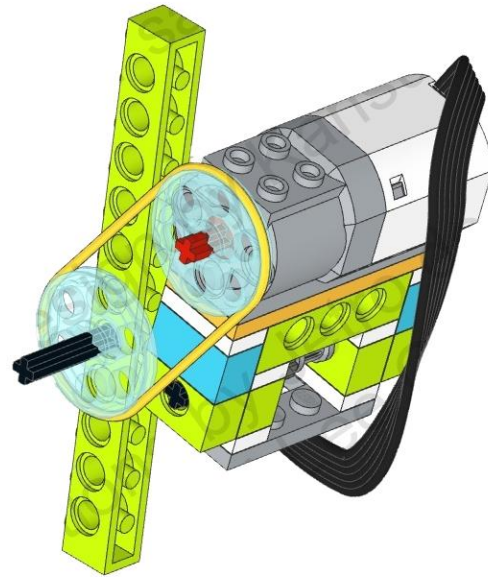

# WEDO 2.0 «РОБОТ R2D2»

14

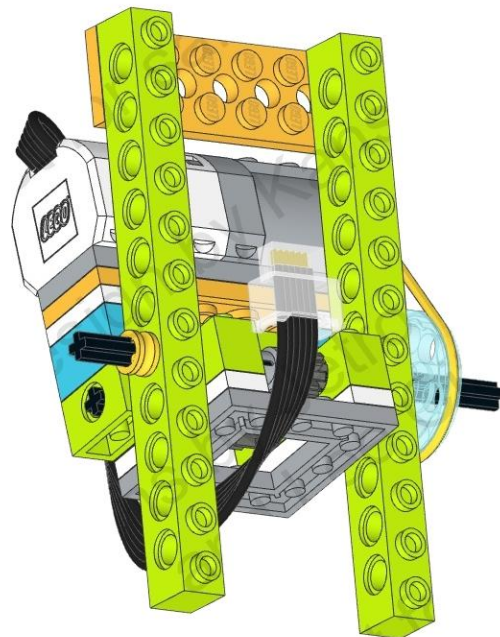
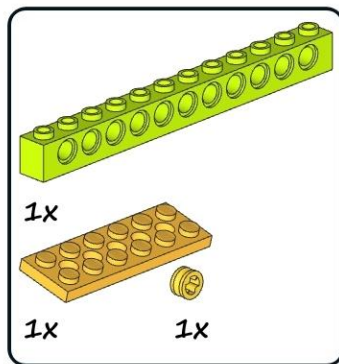



# WEDO 2.0 «РОБОТ R2D2»

15

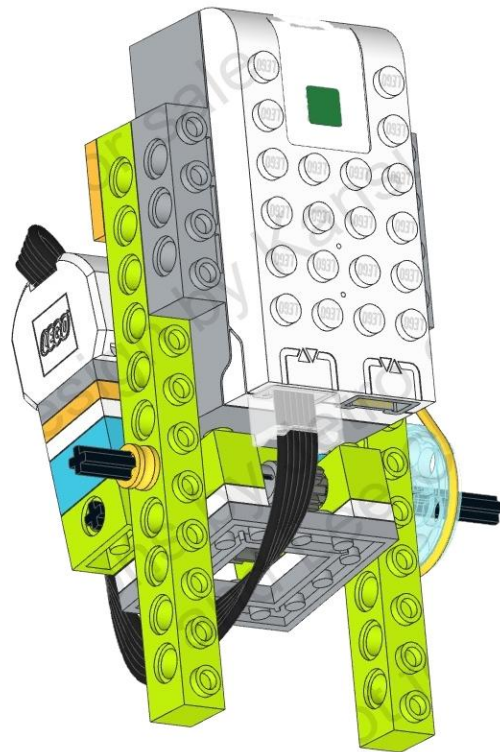
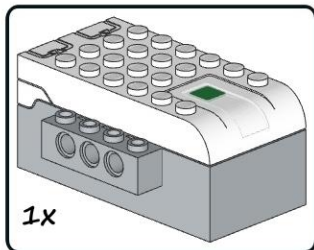

# WEDO 2.0 «РОБОТ R2D2»

16

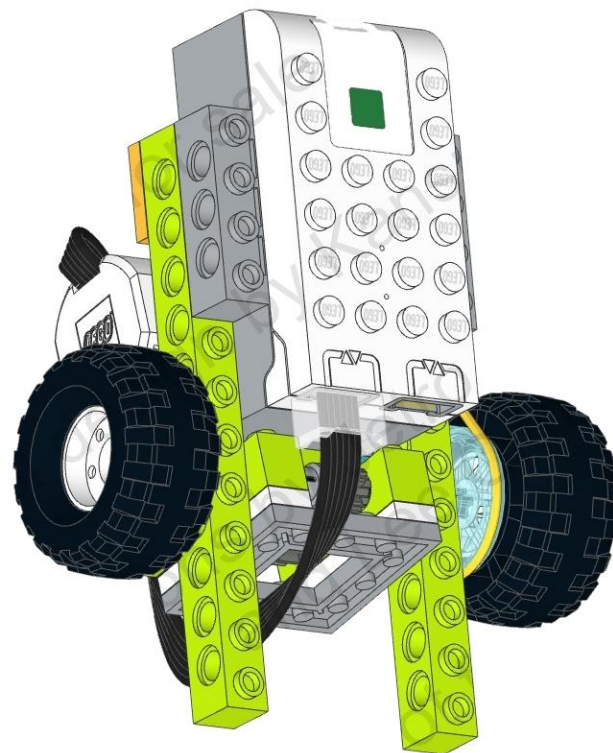
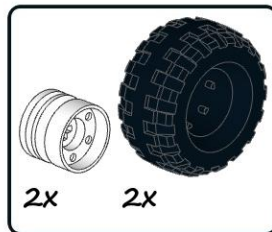

# WEDO 2.0 «РОБОТ R2D2»

17

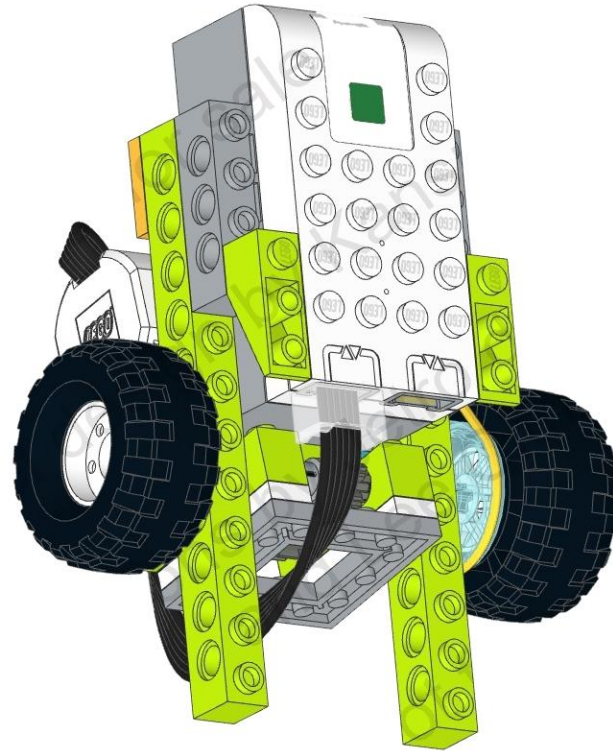
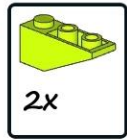

# WEDO 2.0 «РОБОТ R2D2»

18

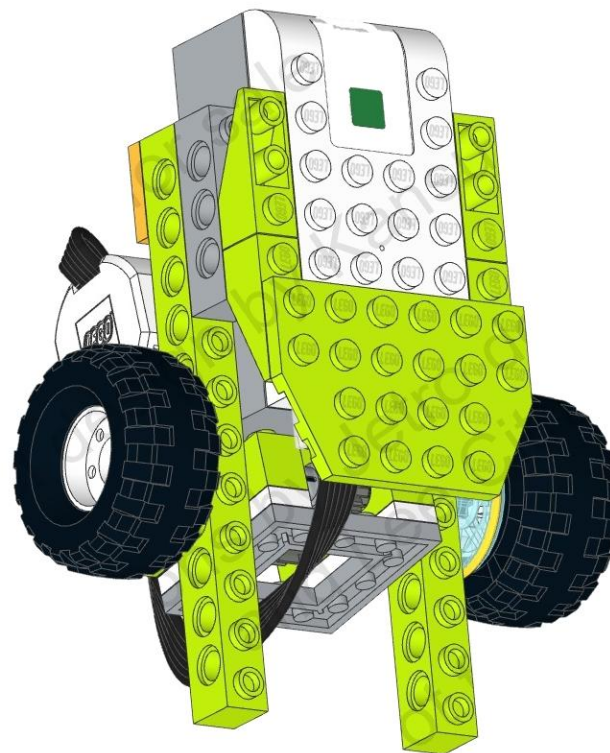
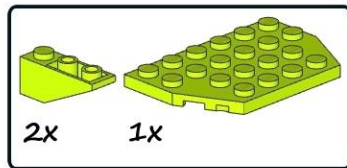

# WEDO 2.0 «РОБОТ R2D2»

19

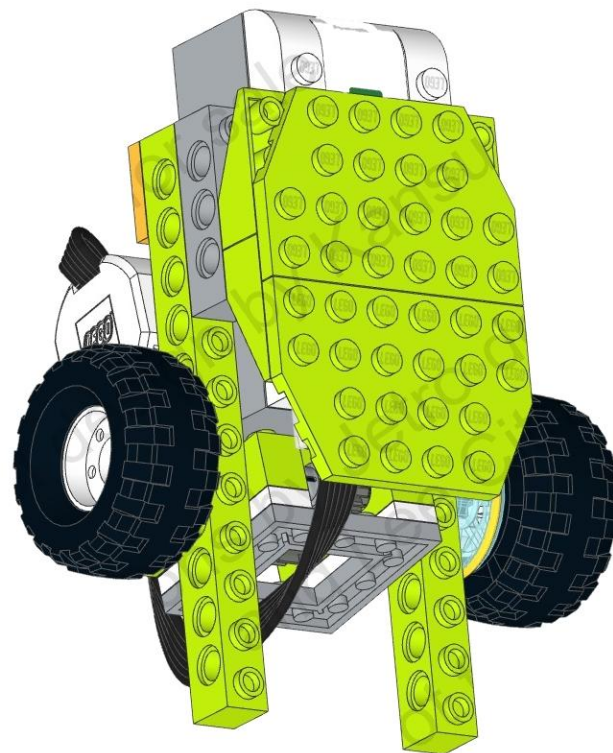
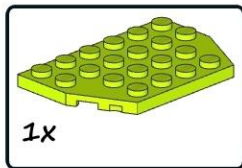

# WEDO 2.0 «РОБОТ R2D2»

20

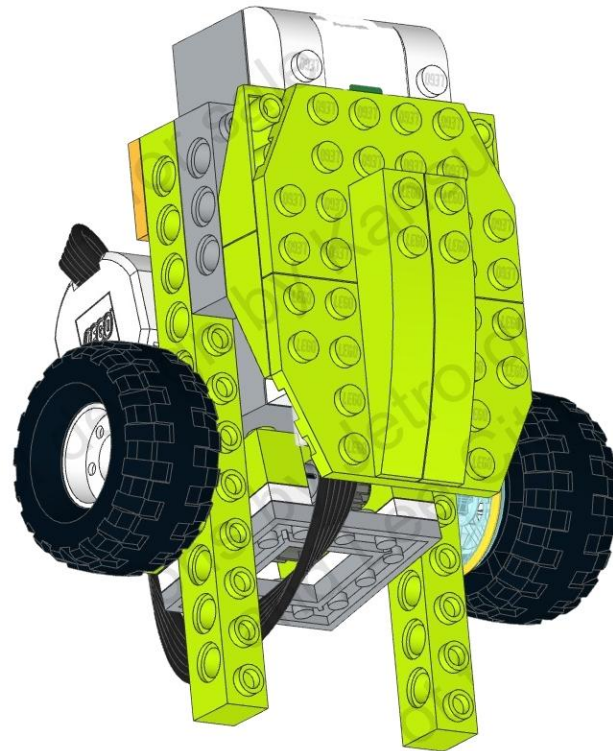
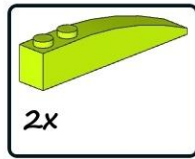

# WEDO 2.0 «РОБОТ R2D2»

21

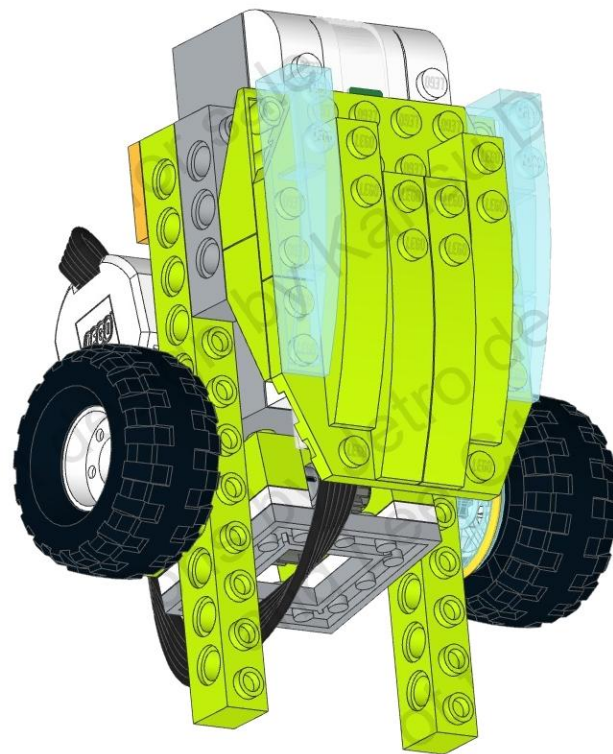
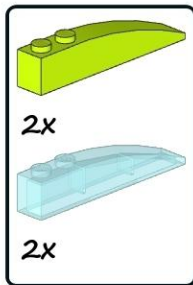

# WEDO 2.0 «РОБОТ R2D2»

22

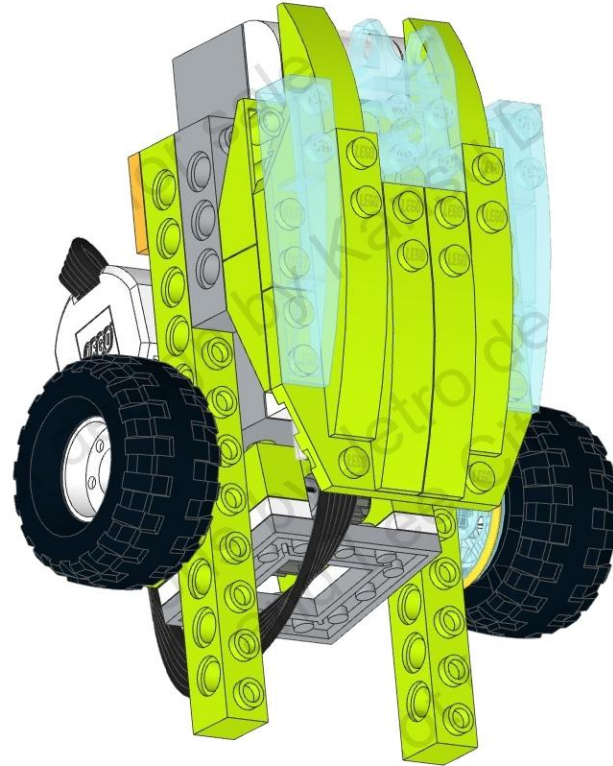
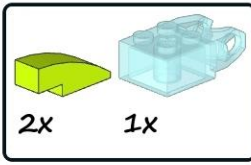



# WEDO 2.0 «РОБОТ R2D2»

23

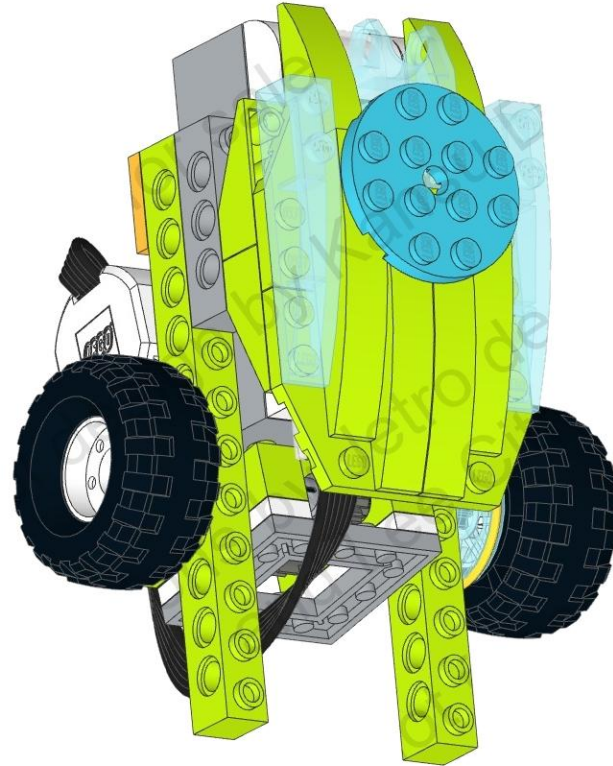
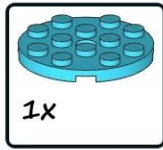

# WEDO 2.0 «РОБОТ R2D2»

24   
1x

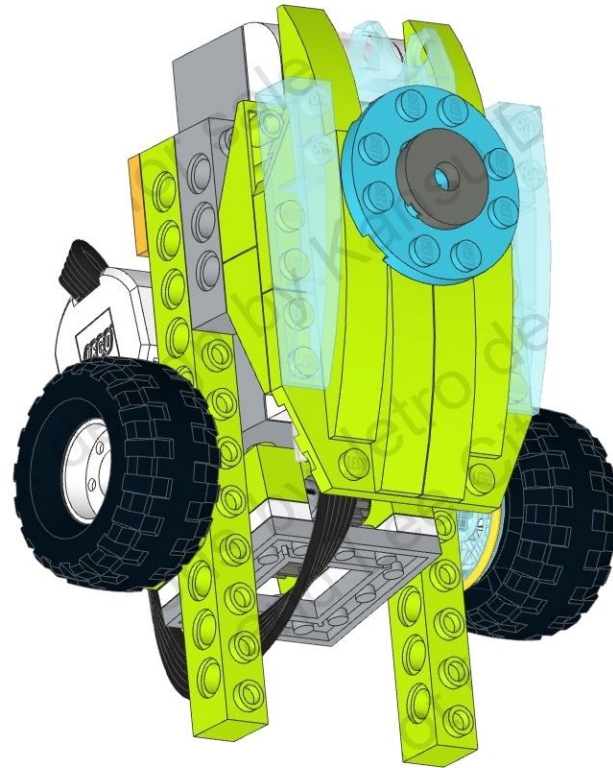

# WEDO 2.0 «РОБОТ R2D2»

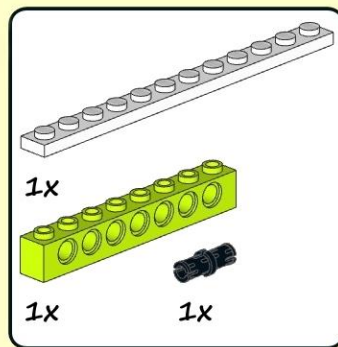

25

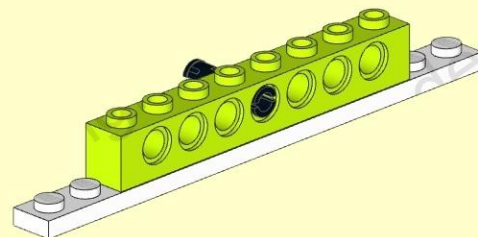

# WEDO 2.0 «РОБОТ R2D2»

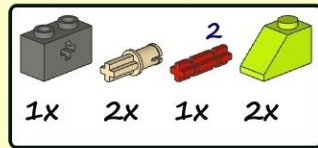

26

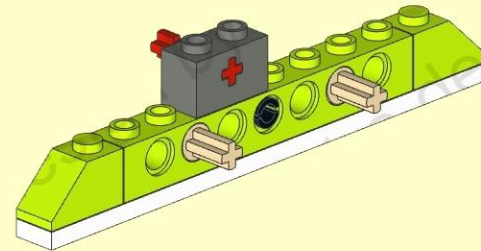

# WEDO 2.0 «РОБОТ R2D2»



27

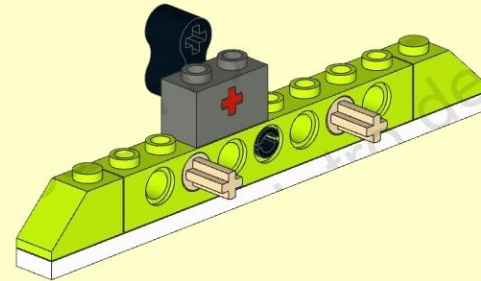

# WEDO 2.0 «РОБОТ R2D2»



28

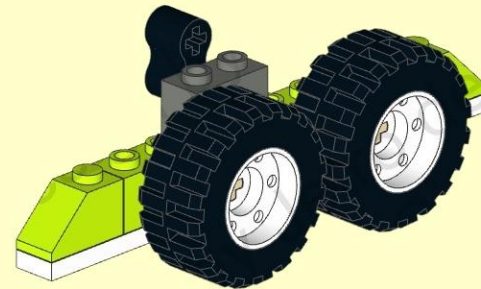

# WEDO 2.0 «РОБОТ R2D2»

29

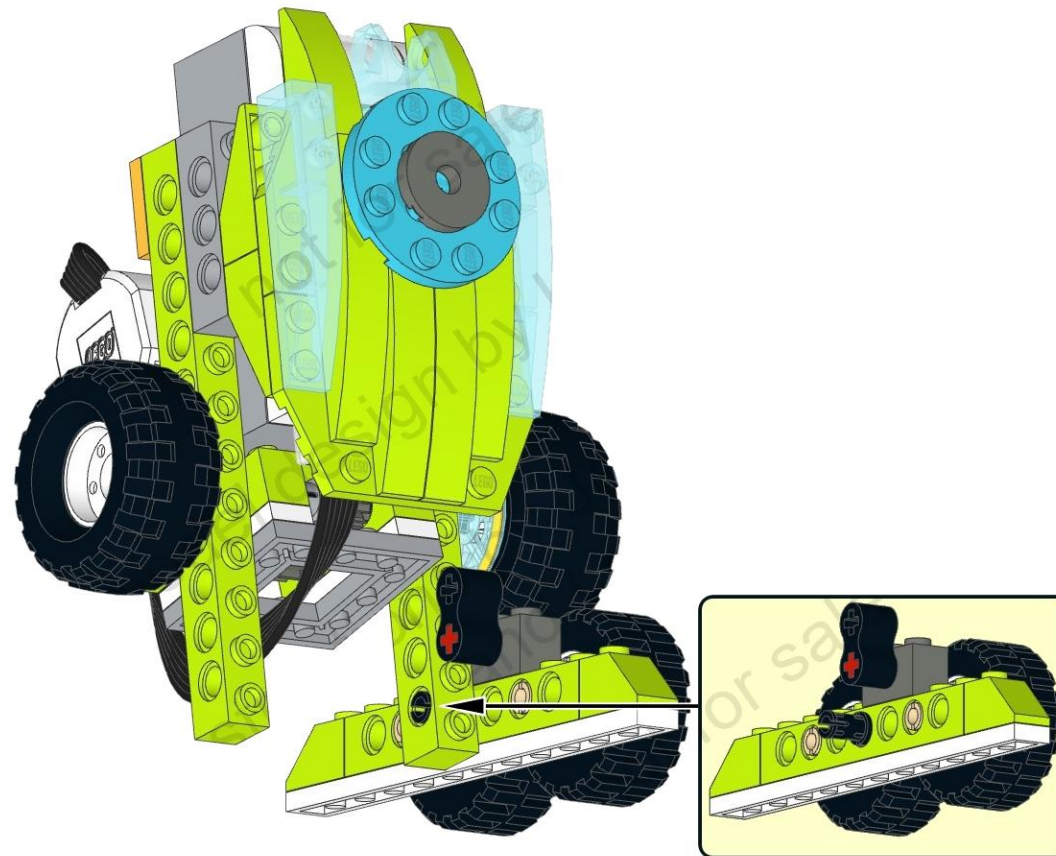

# WEDO 2.0 «РОБОТ R2D2»

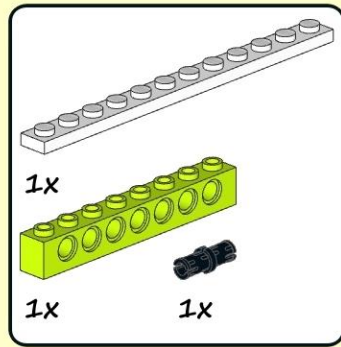

**30**

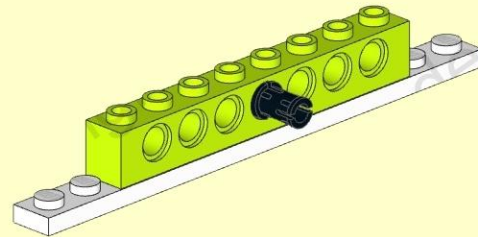



# WEDO 2.0 «РОБОТ R2D2»

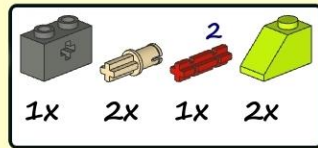

**31**

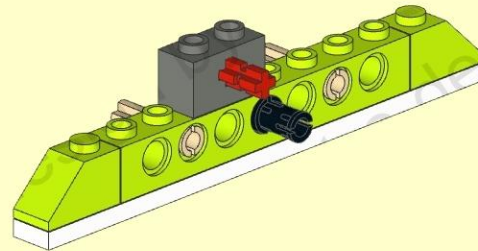

# WEDO 2.0 «РОБОТ R2D2»



32

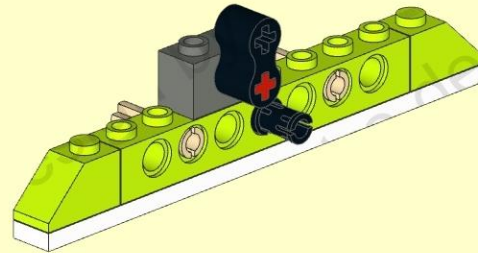

# WEDO 2.0 «РОБОТ R2D2»

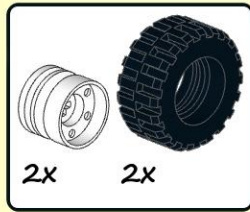

**33**

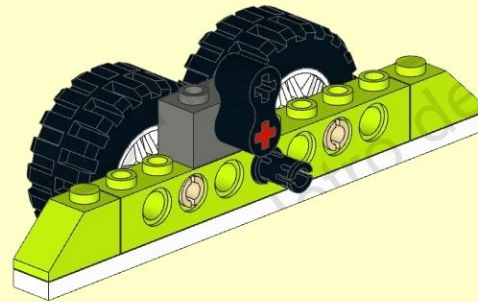

# WEDO 2.0 «РОБОТ R2D2»

34

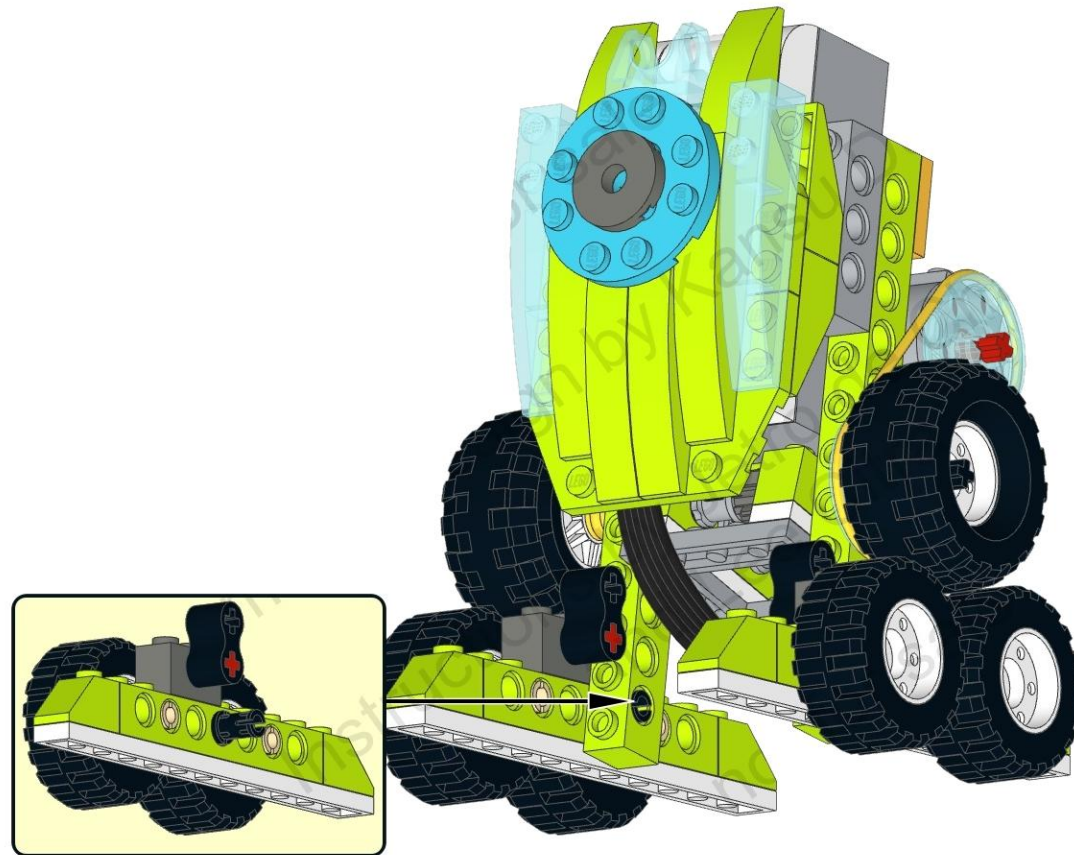

# WEDO 2.0 «РОБОТ R2D2»

УПРАВЛЯЮЩАЯ ПРОГРАММА:



# WEDO 2.0 «РОБОТ R2D2»

## ЗАДАНИЯ:

- 1) Поставьте на робота датчик движения и вставьте данный блок в управляющую программу.
- 2) Добавьте в управляющую программу блок цвета и заставьте смарт-хаб светиться, при движении робота, разными цветами.

WEDO 2.0 «РОБОТ R2D2»

Спасибо за  
работу!

<https://monitorbank.ru>