

Операционные Системы Реального Времени

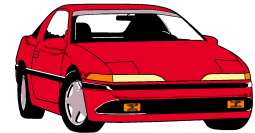

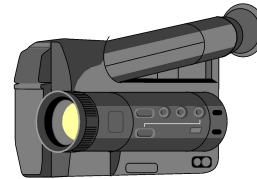

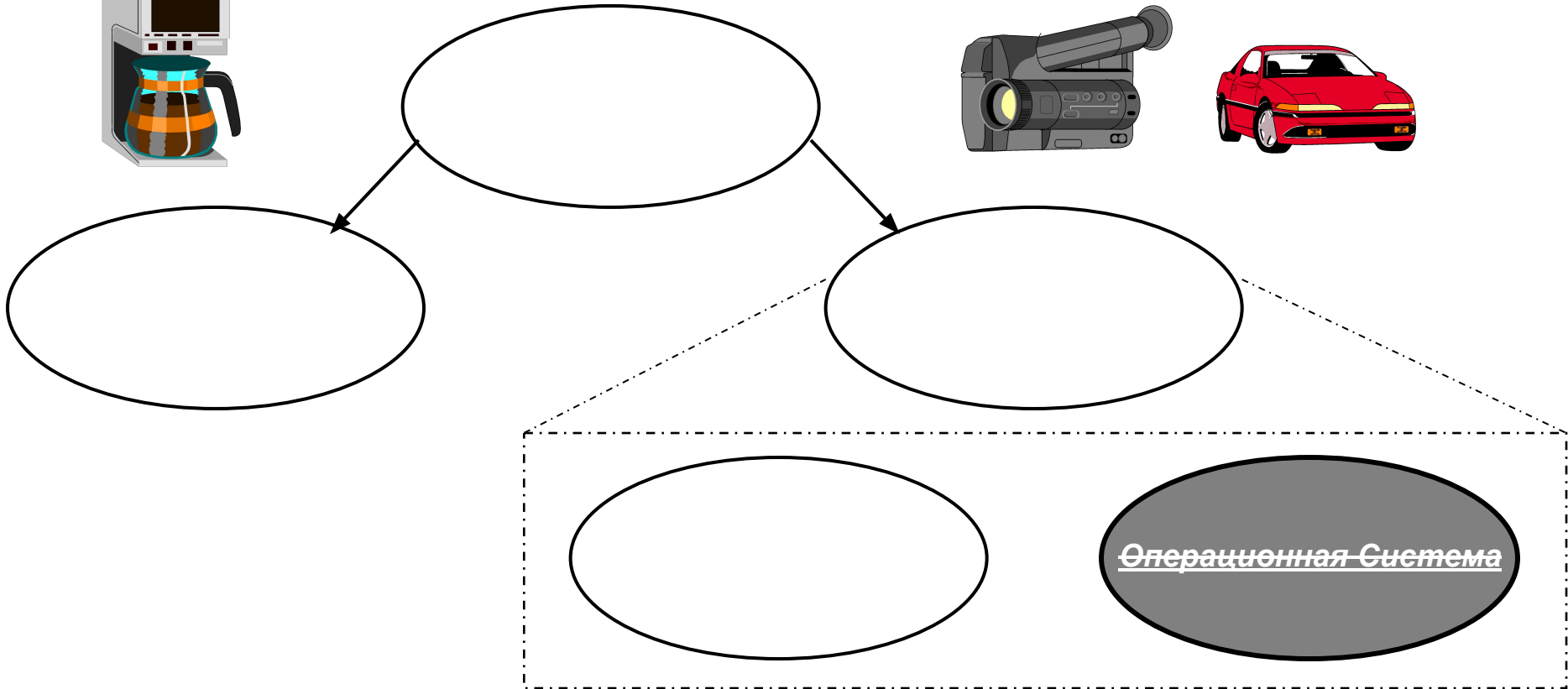

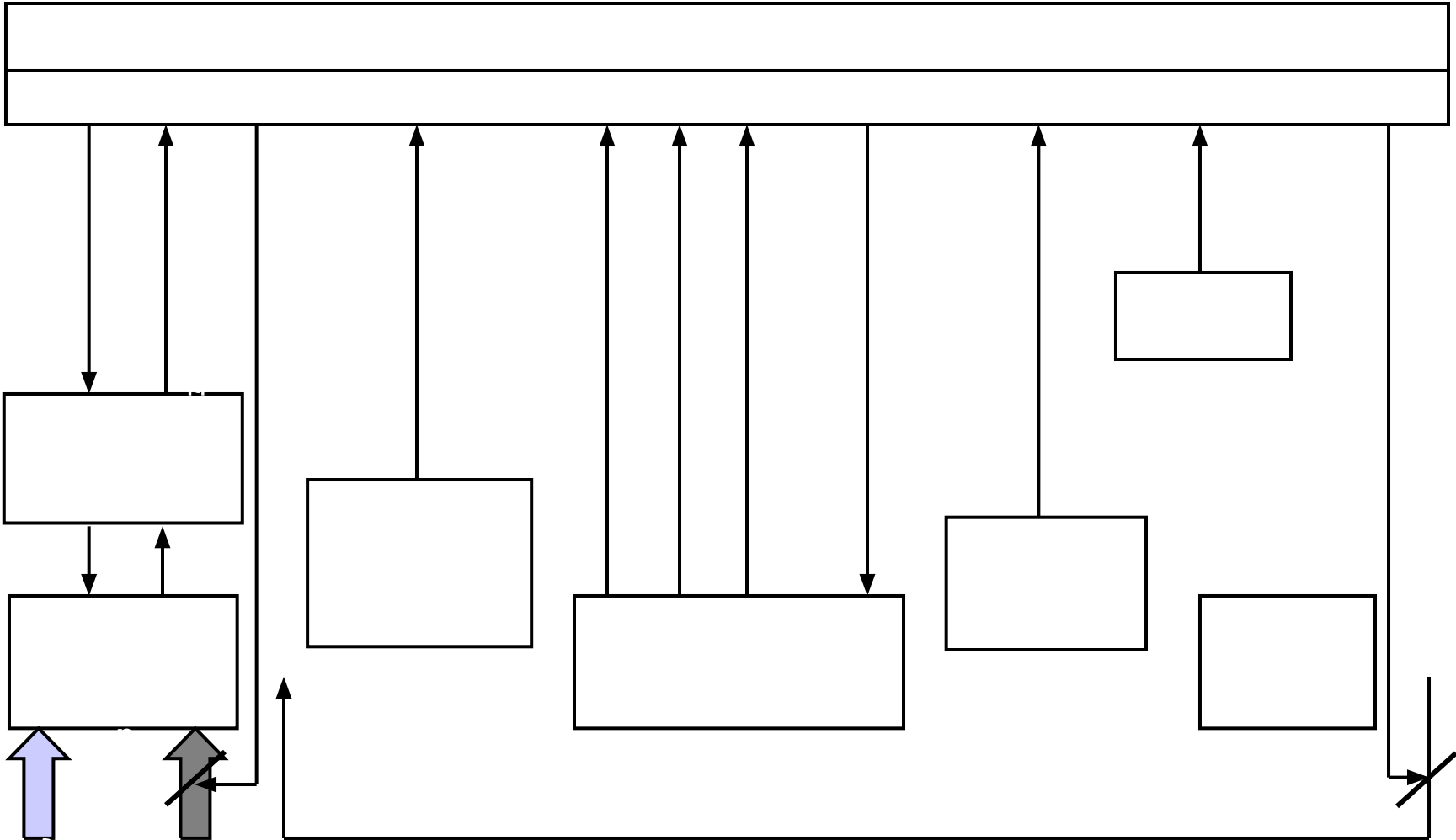
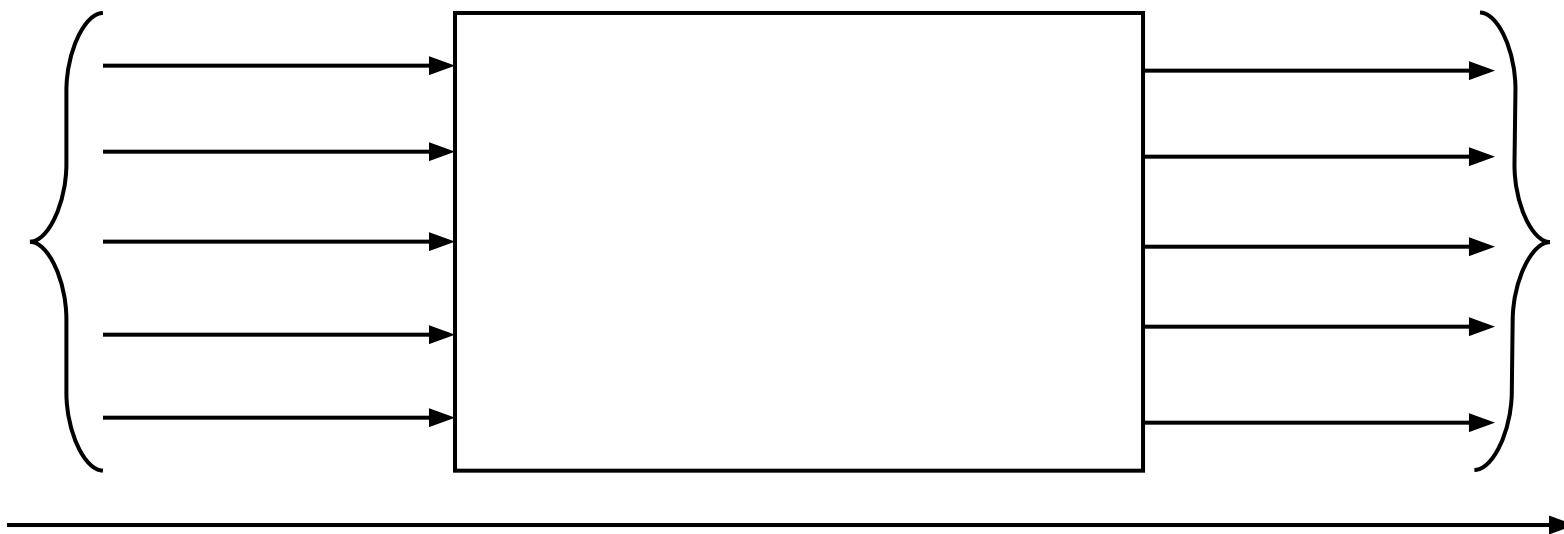

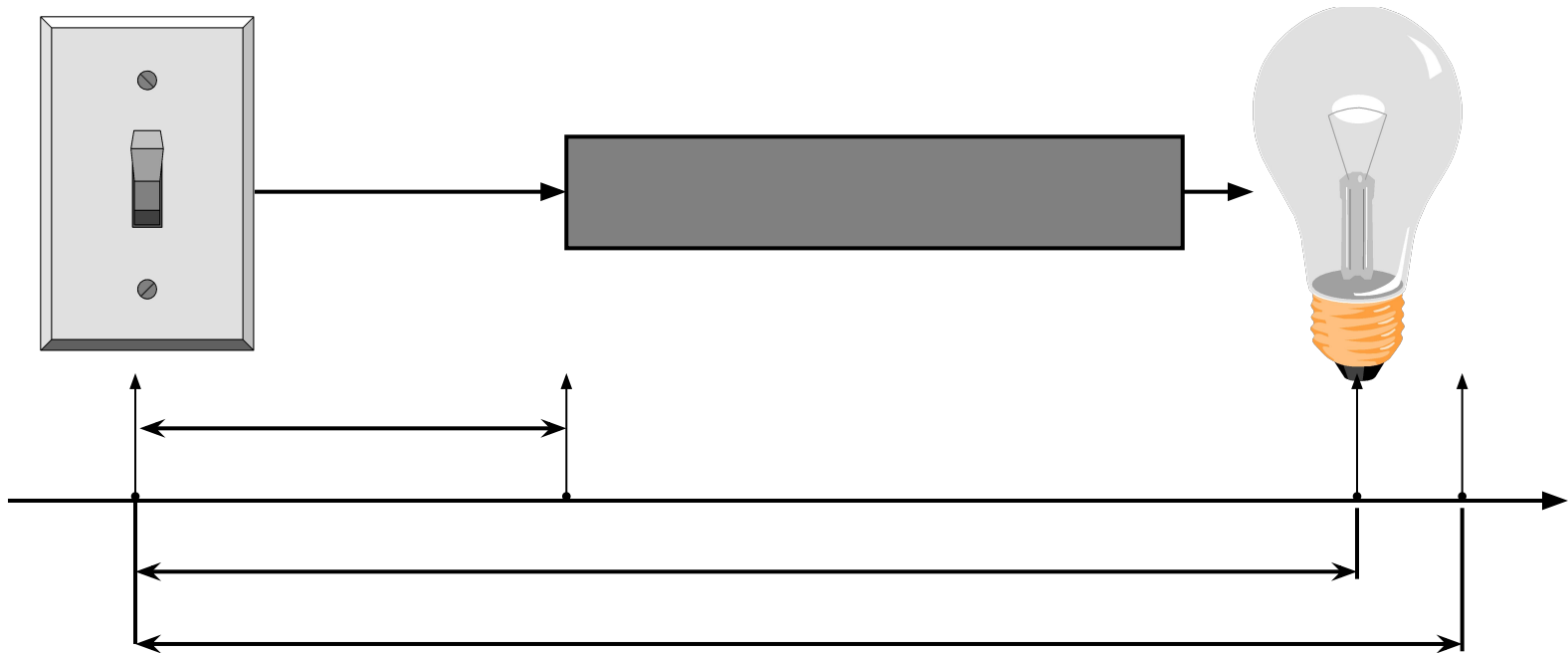

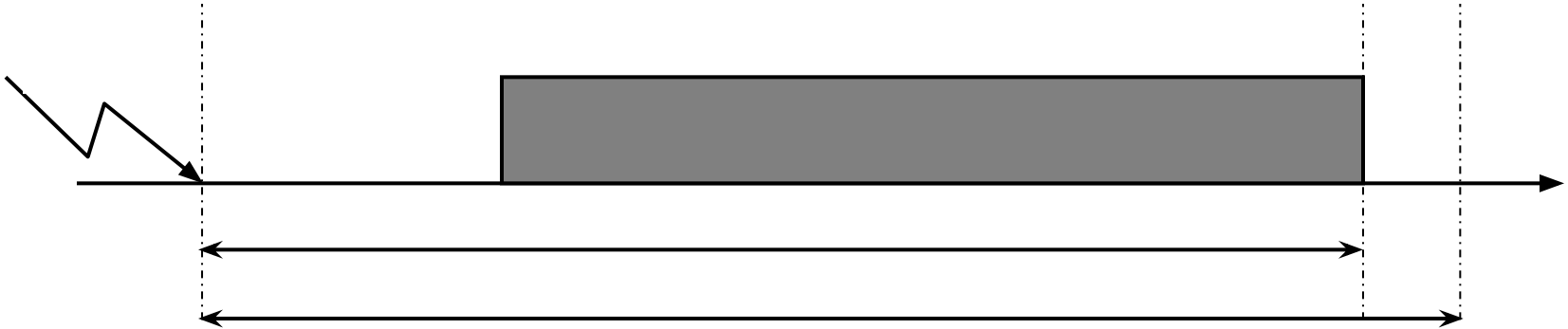

-
-
-

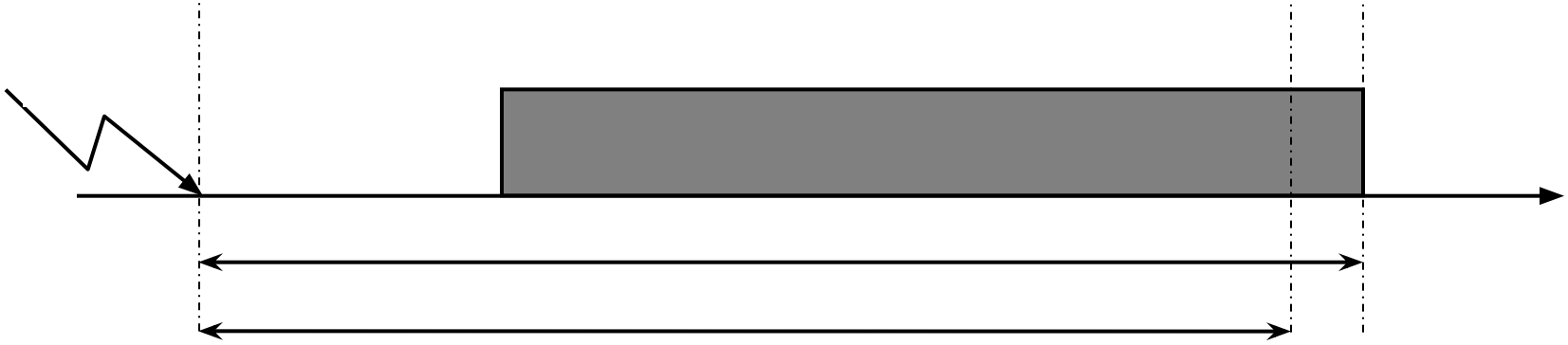

-
-
-

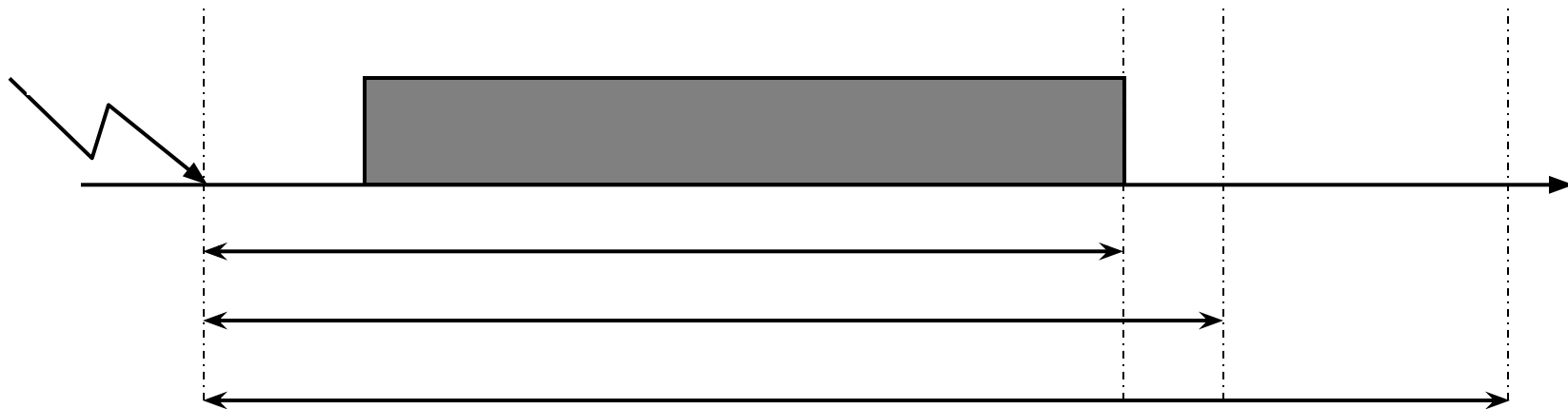

•
•

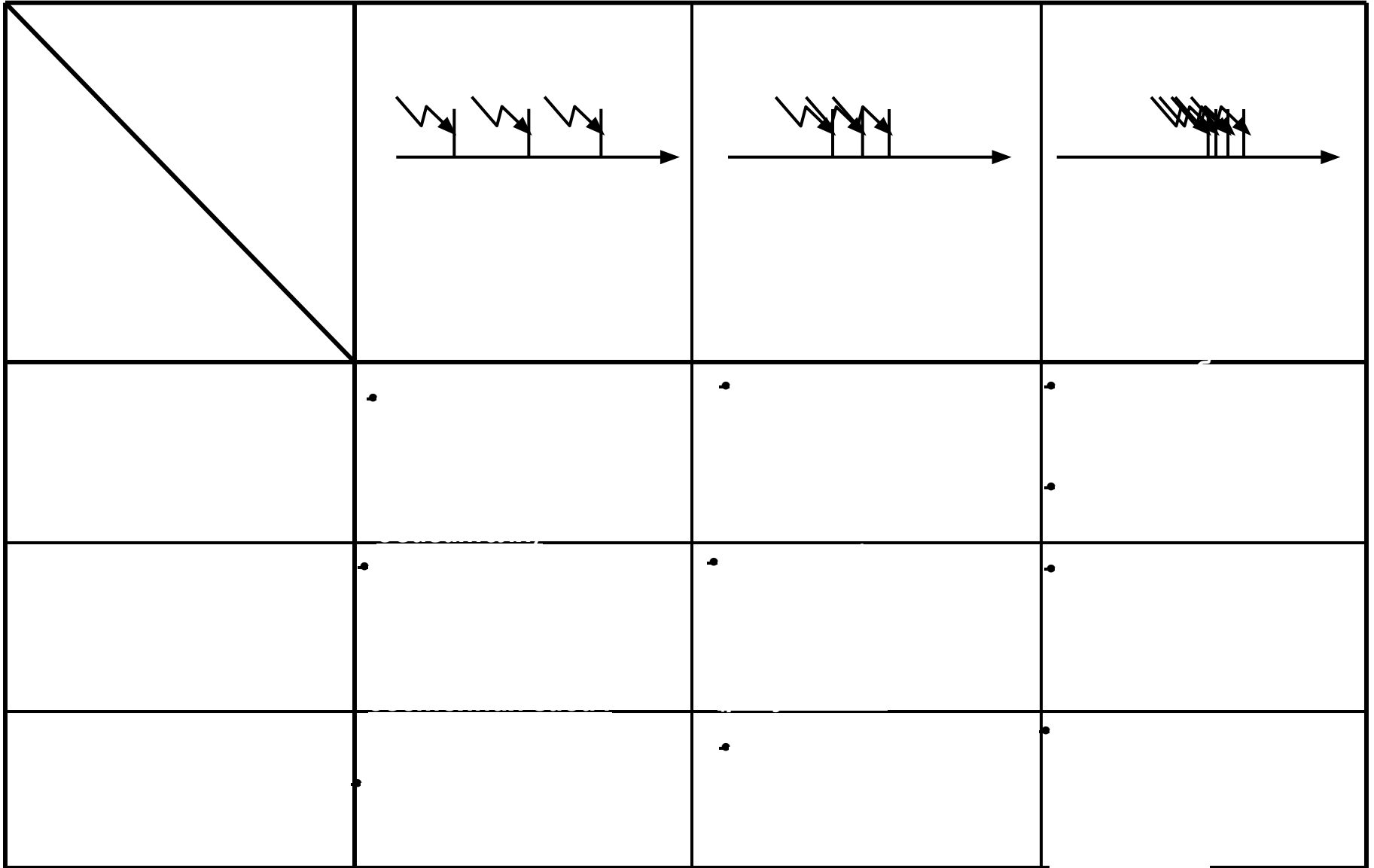

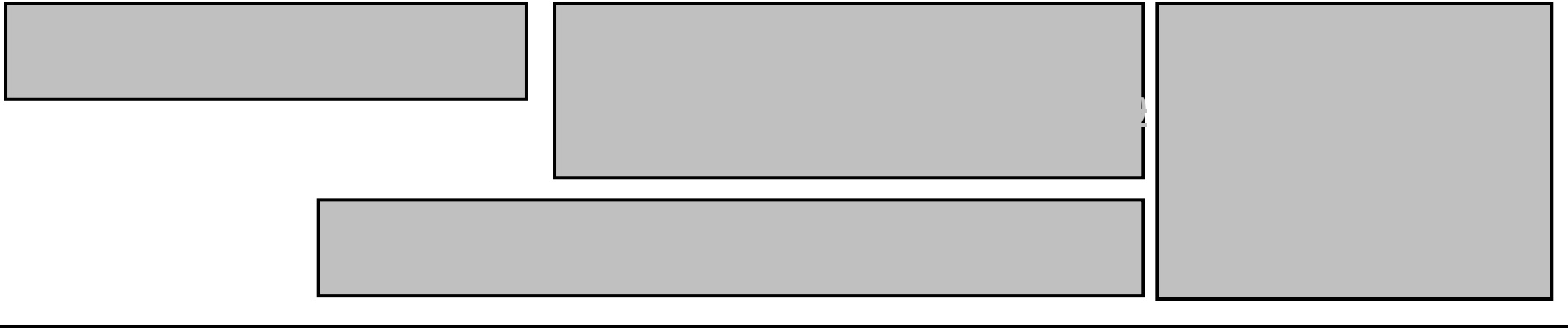

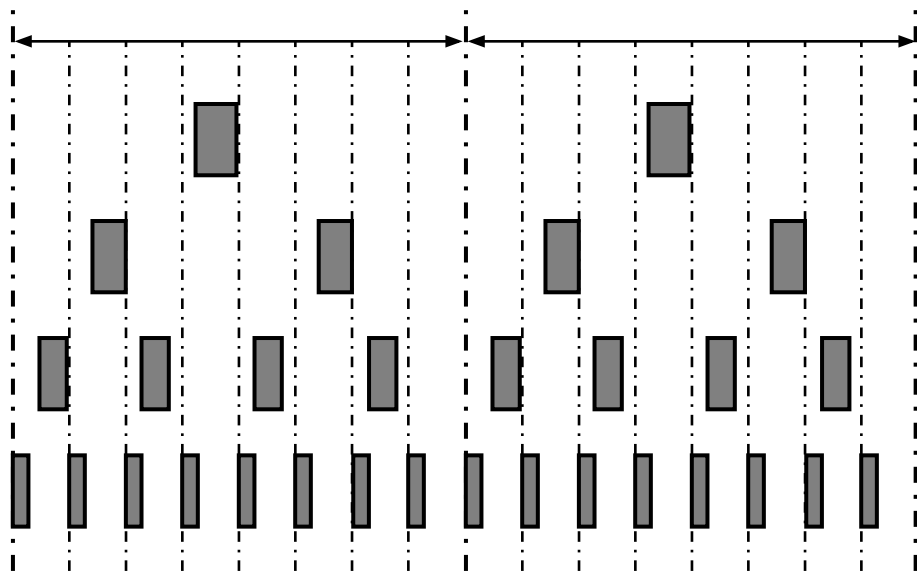

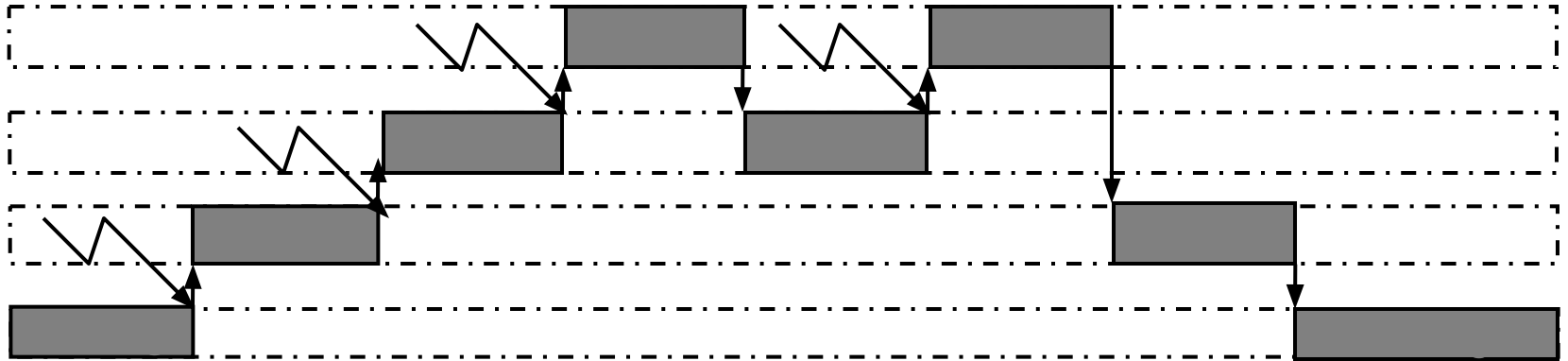
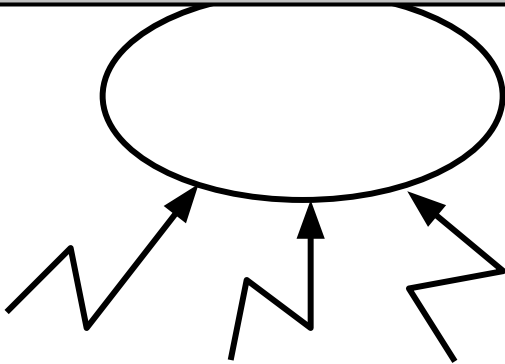

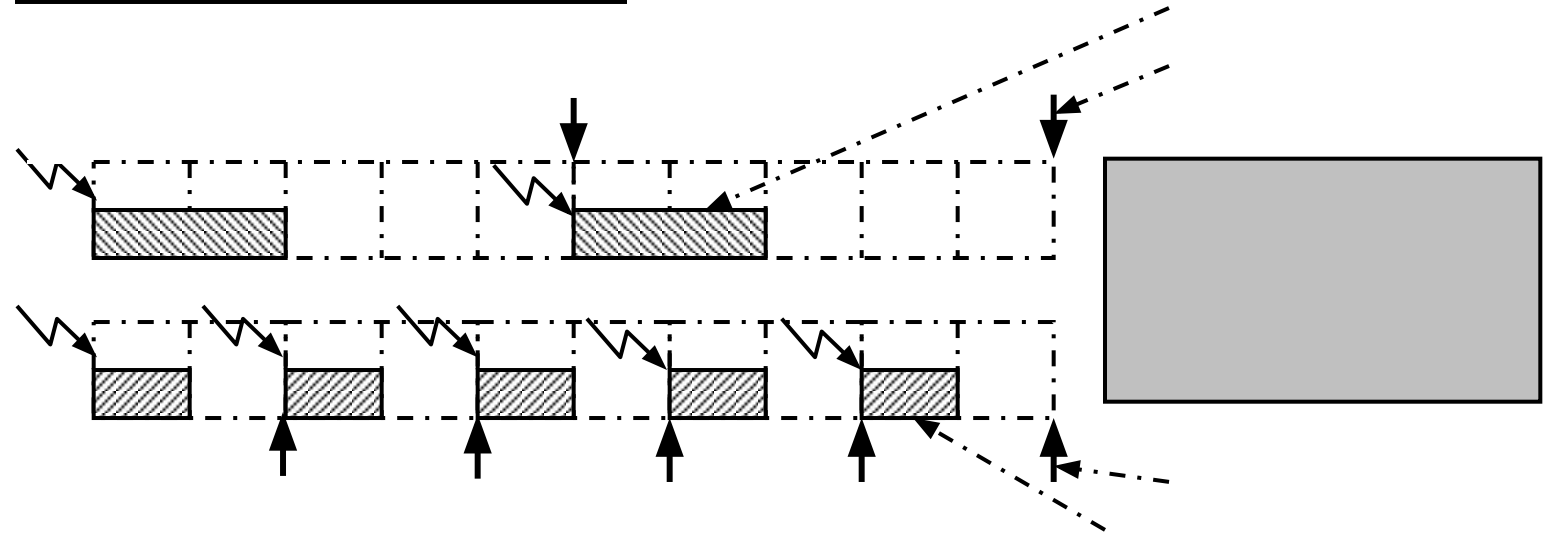
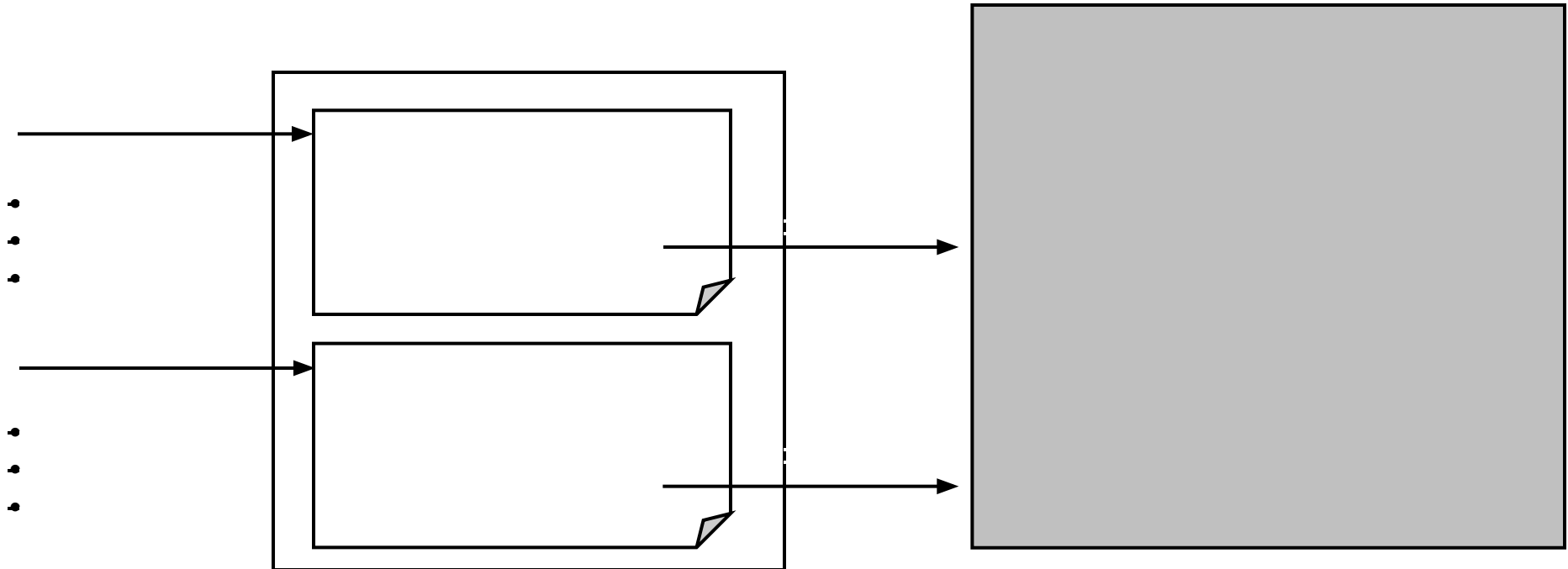

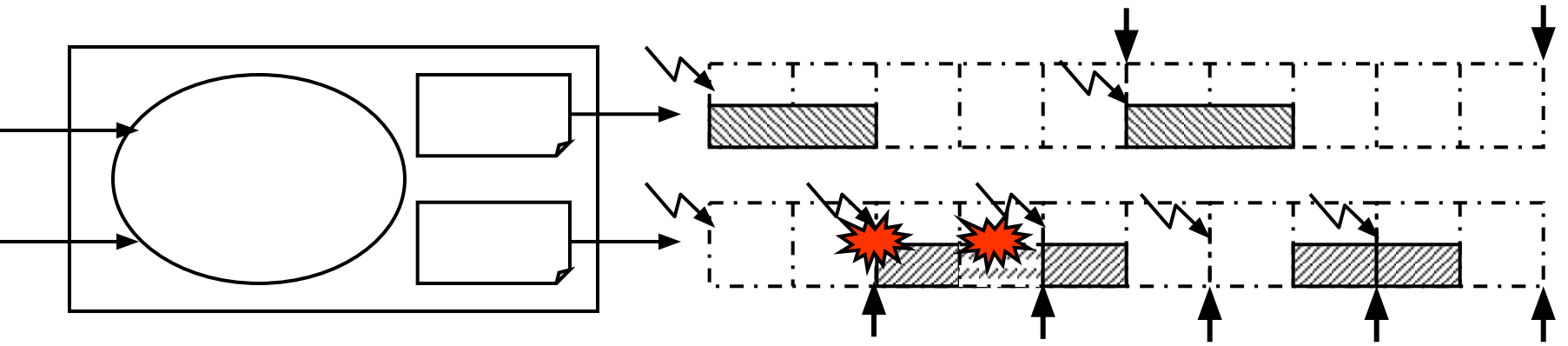
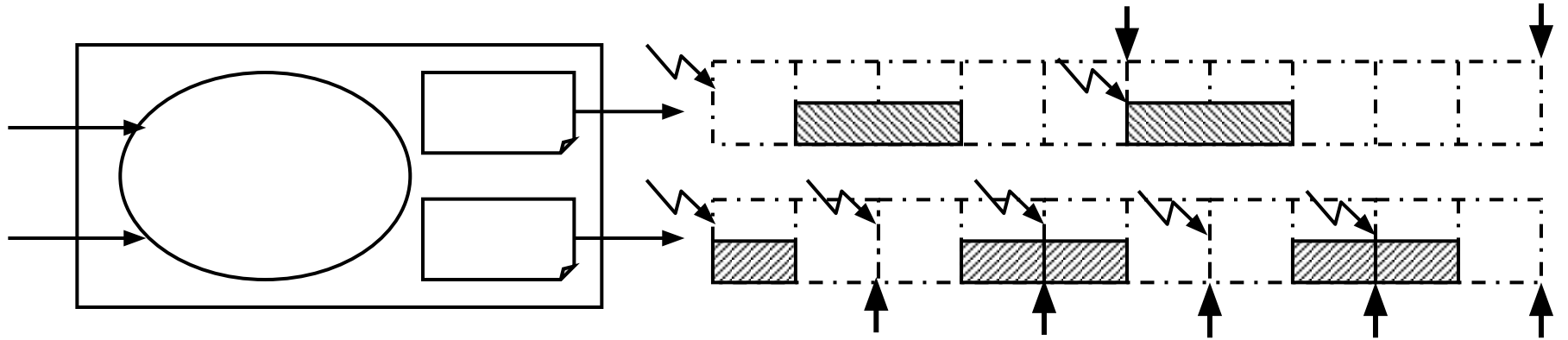

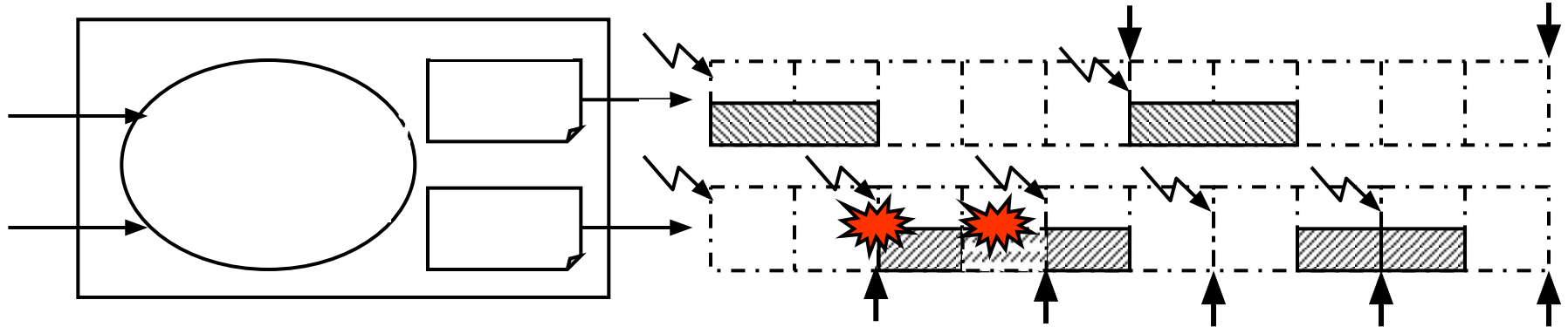
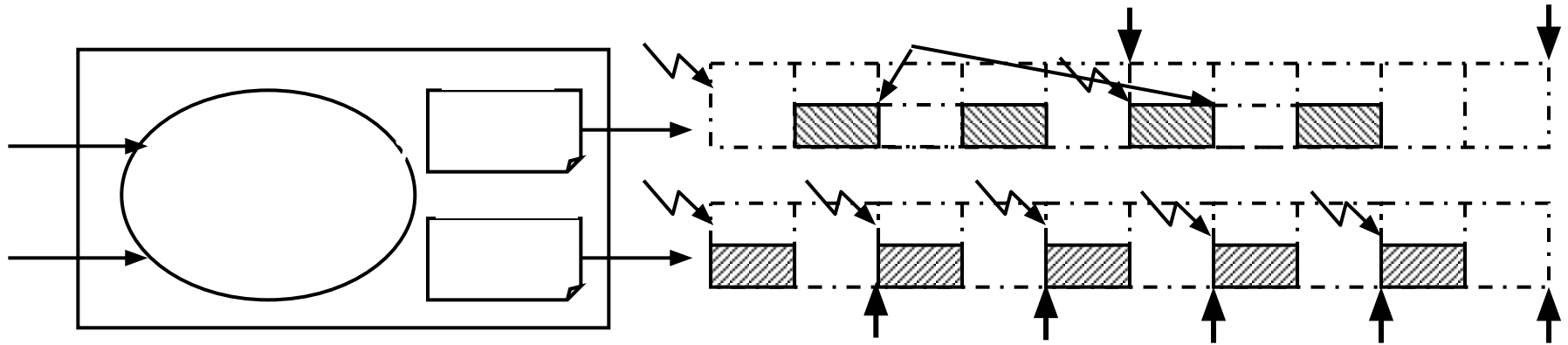

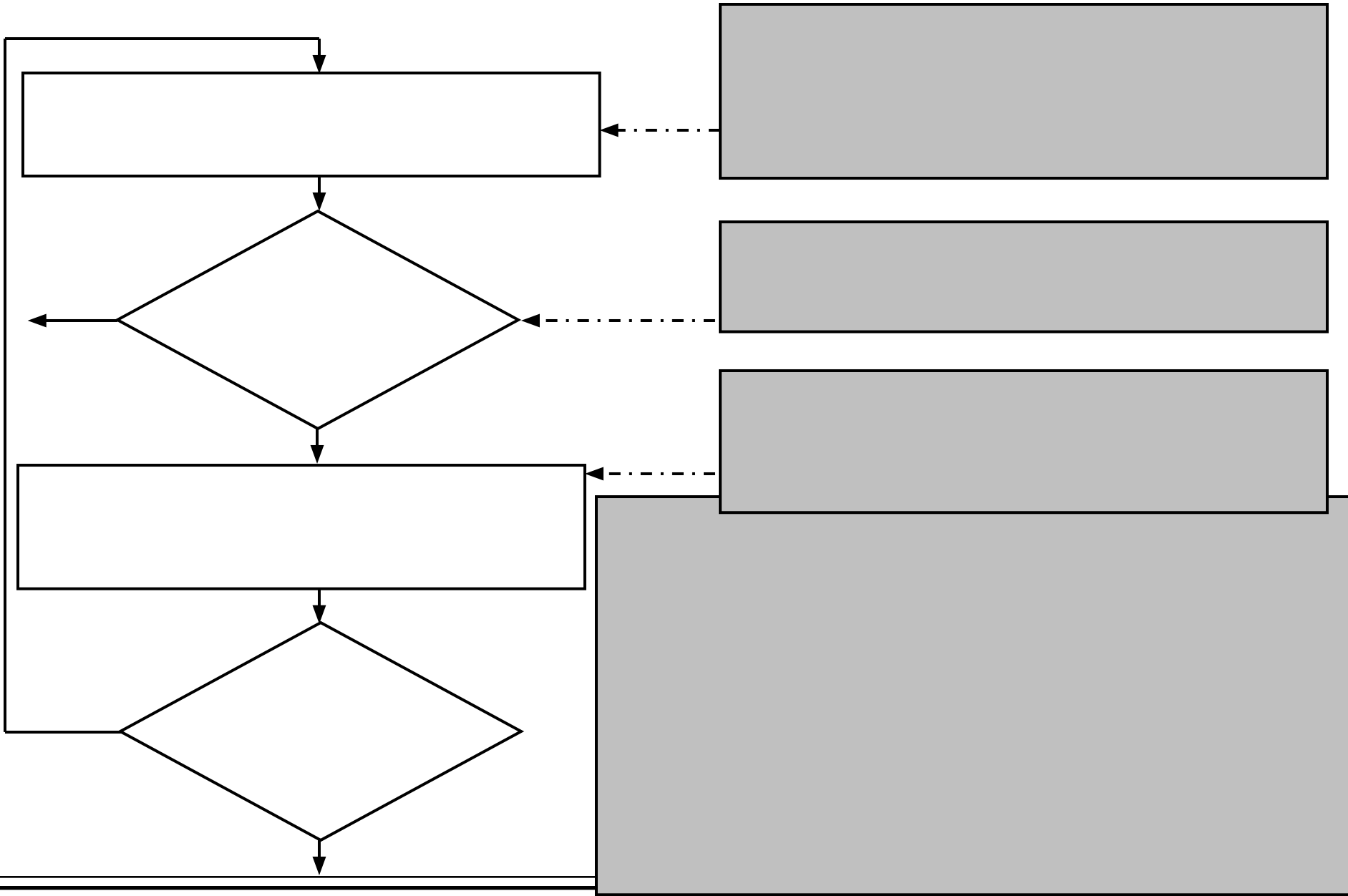

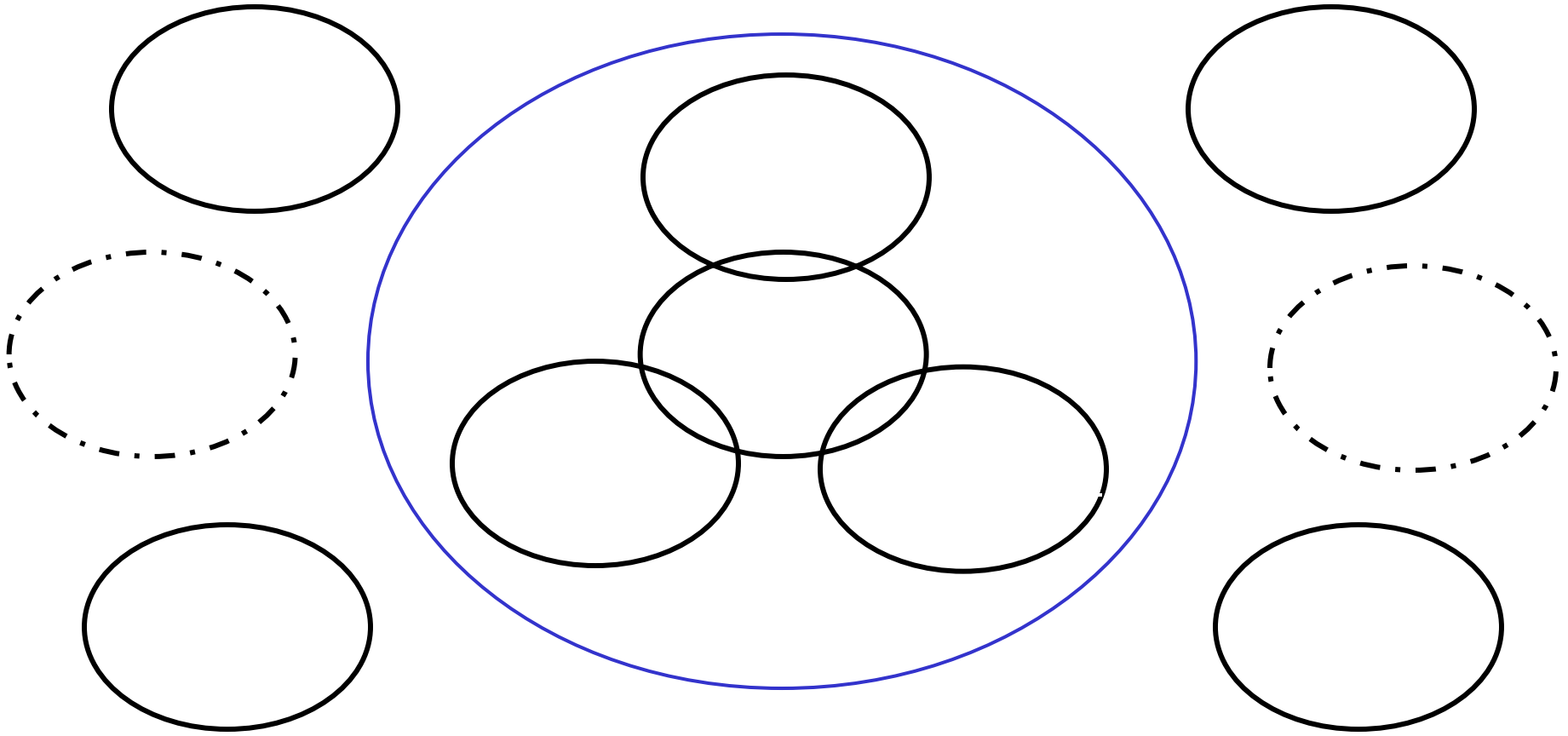

•
•
•
•
•
•
•
•

•
•
•
•
•
•
•
•

•
•
•
•
•
•
•
•

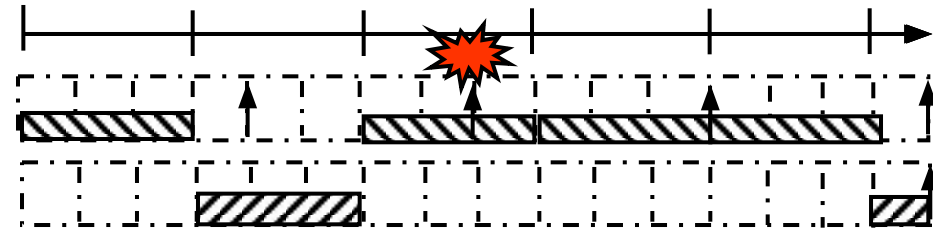
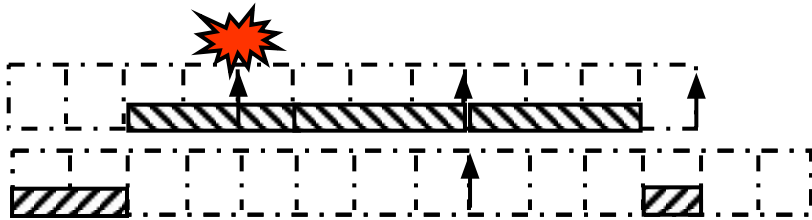
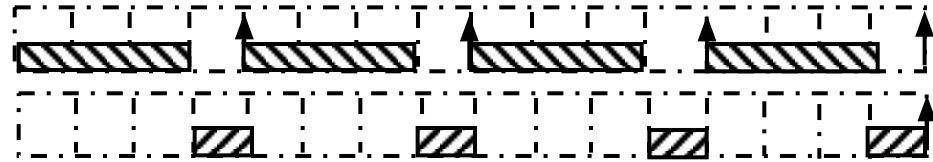
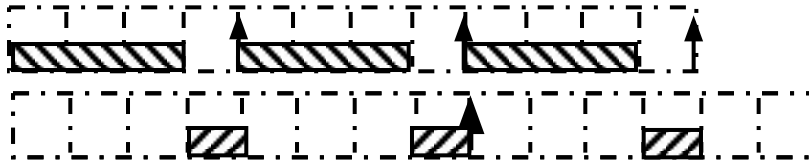

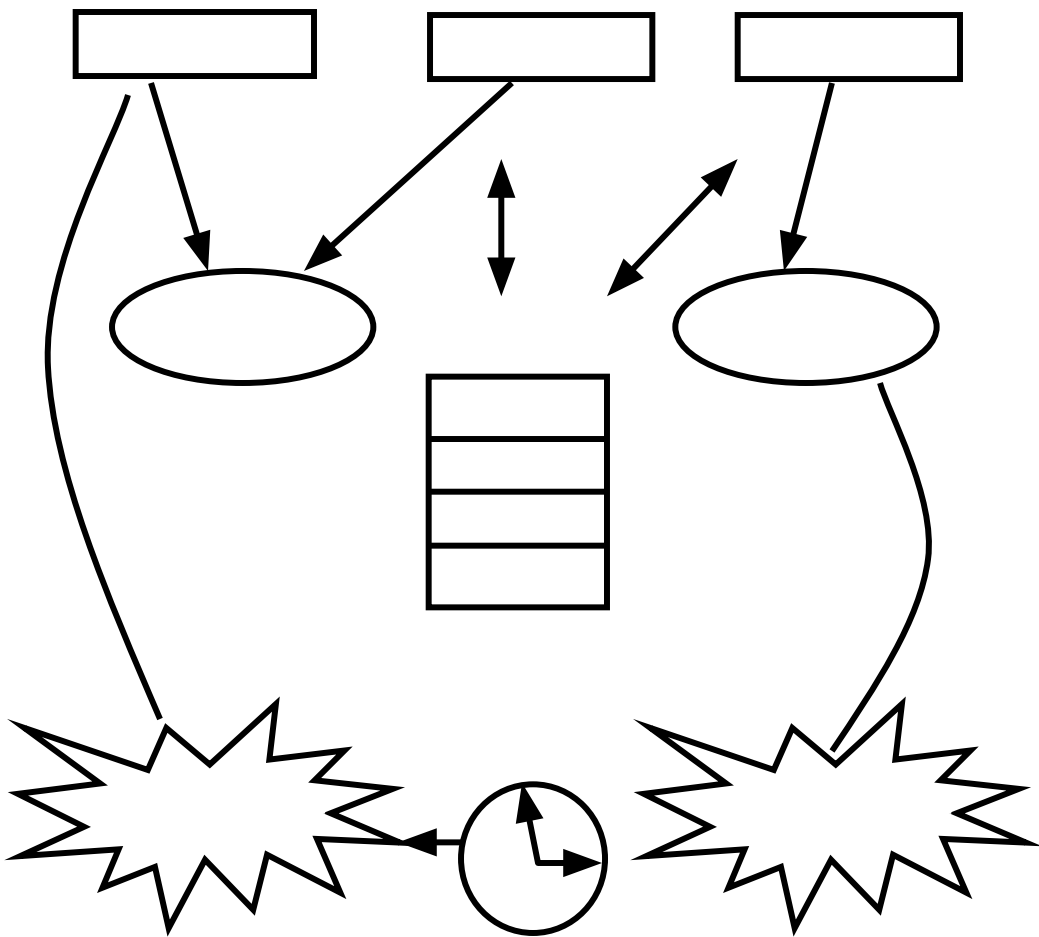

Задачи

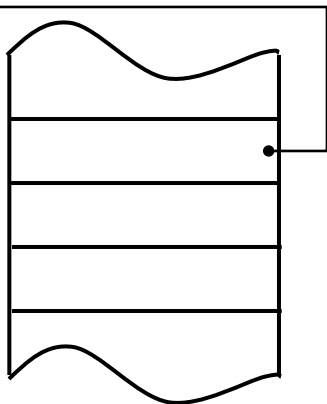
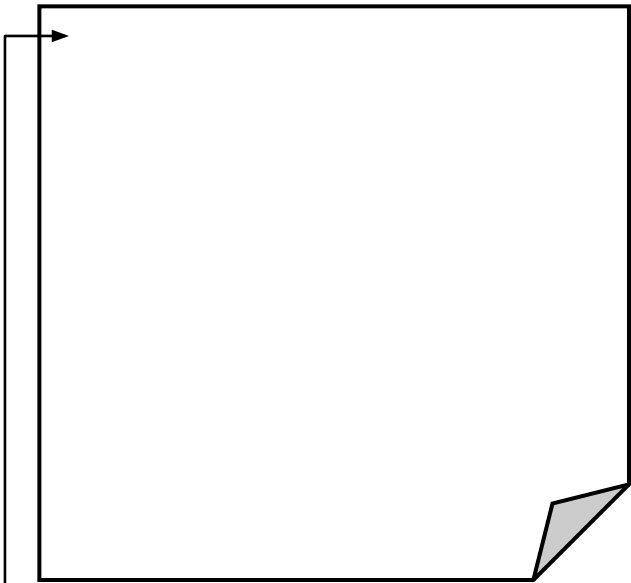

дерывання



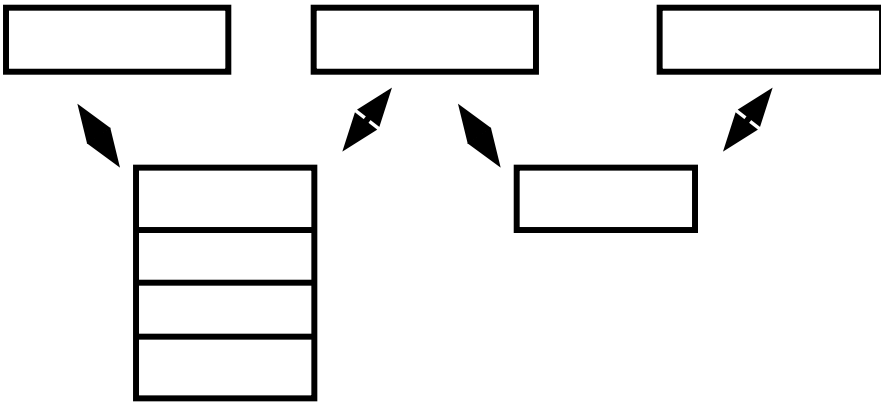
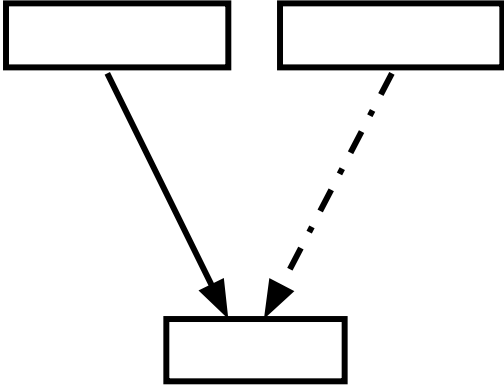

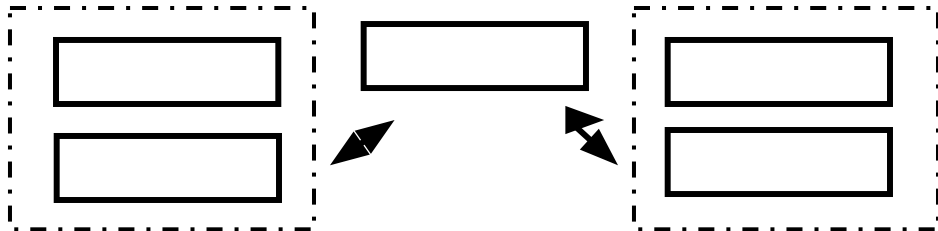

КІСЬ

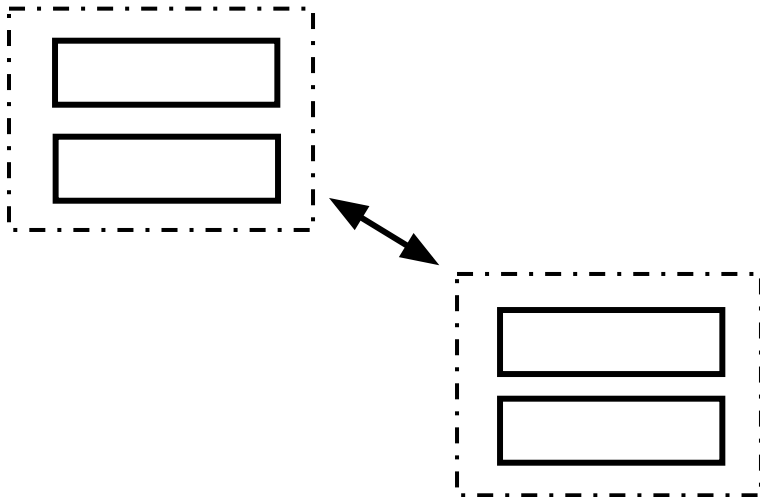

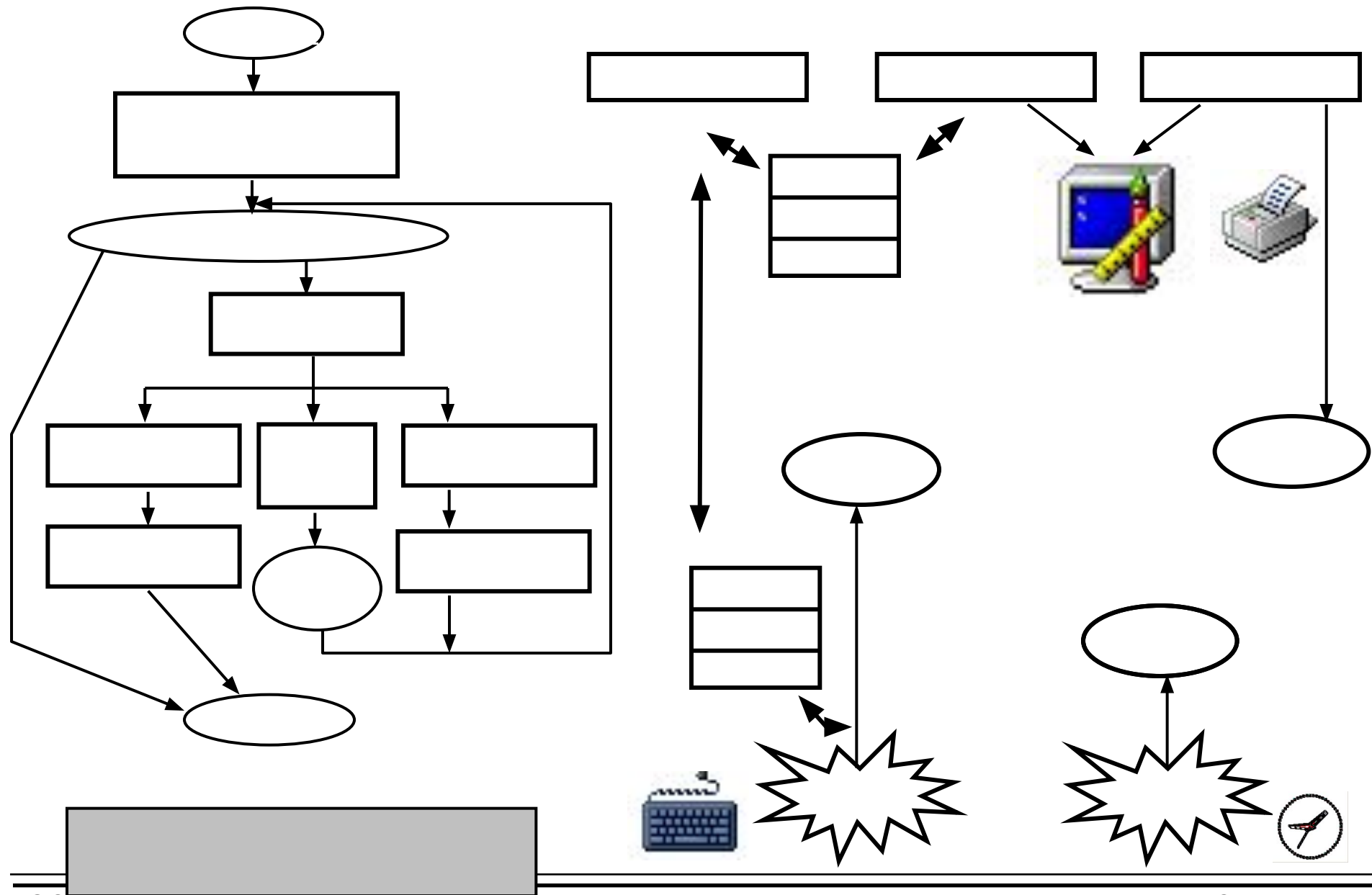

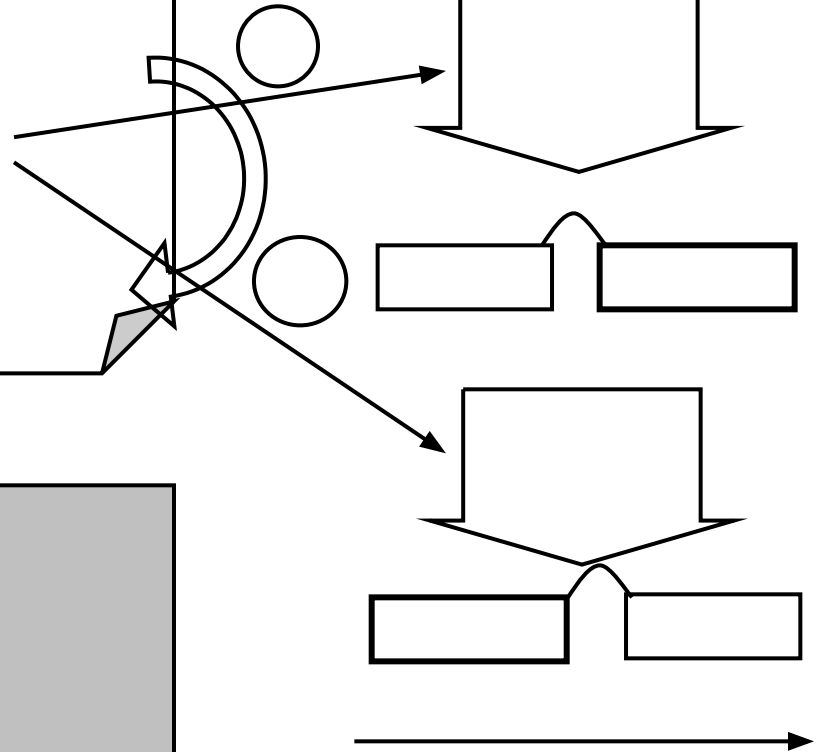
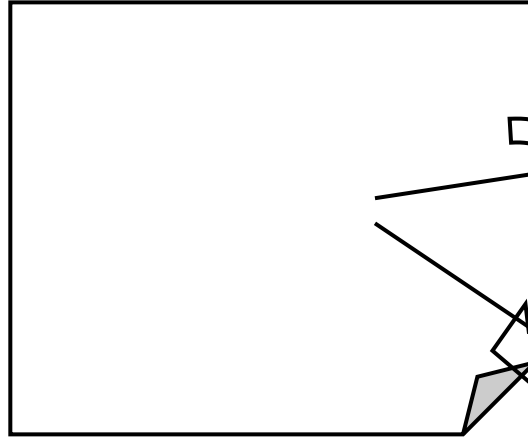
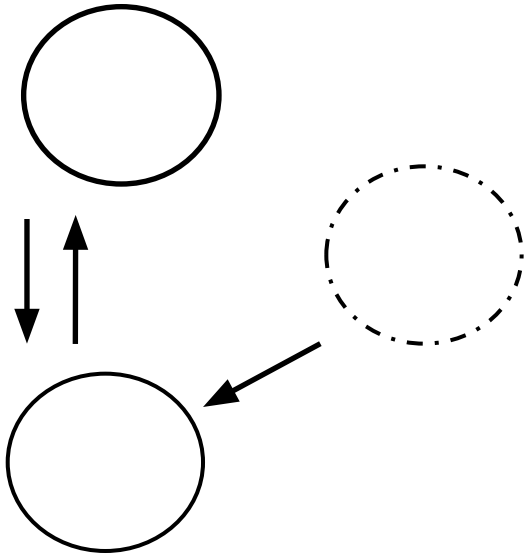



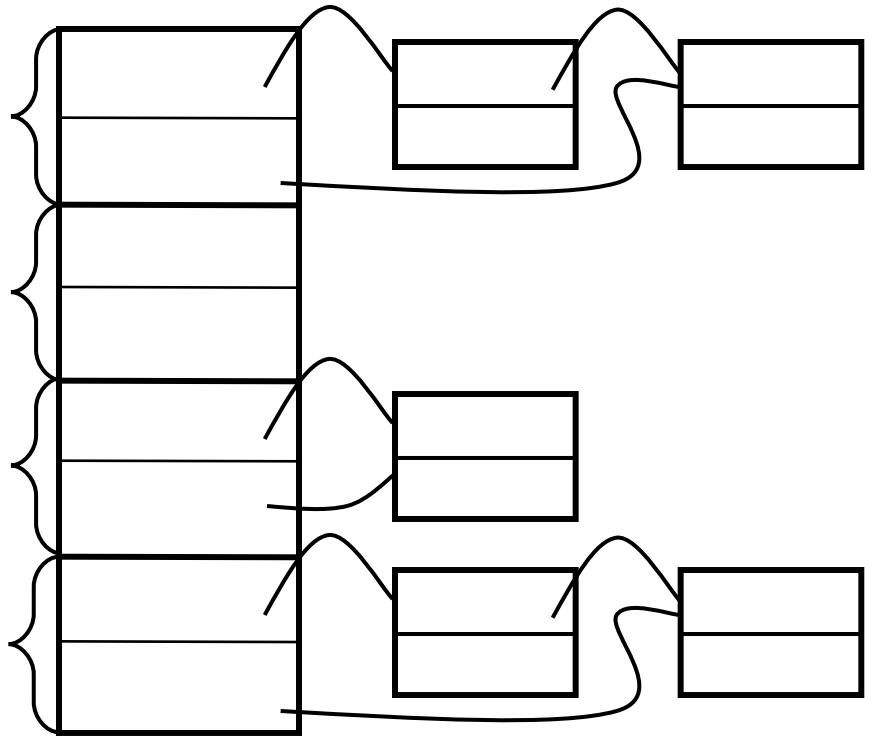
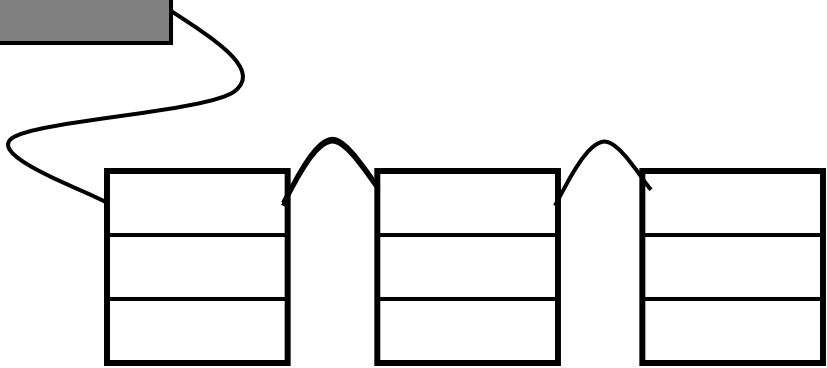

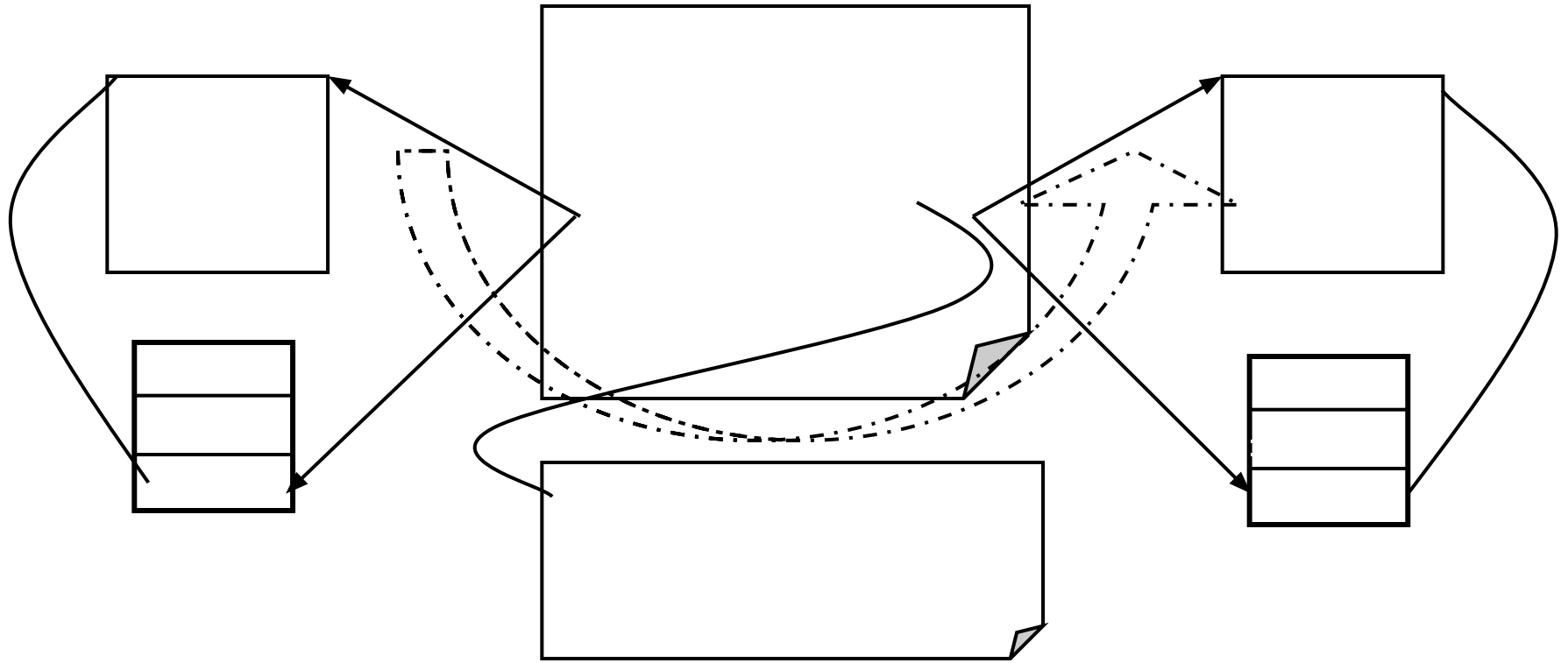

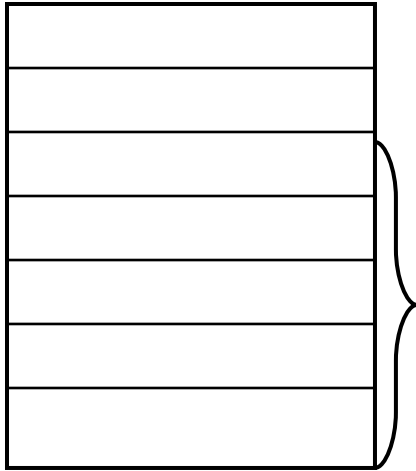

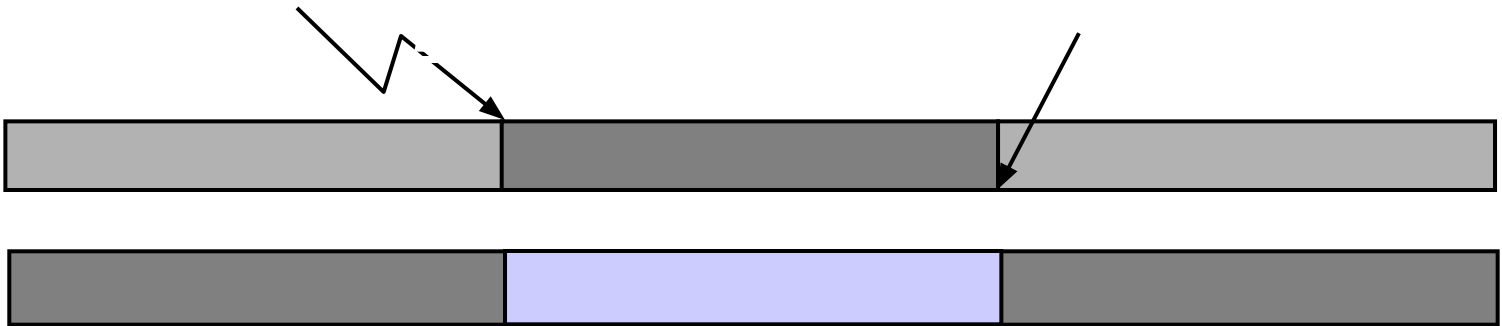
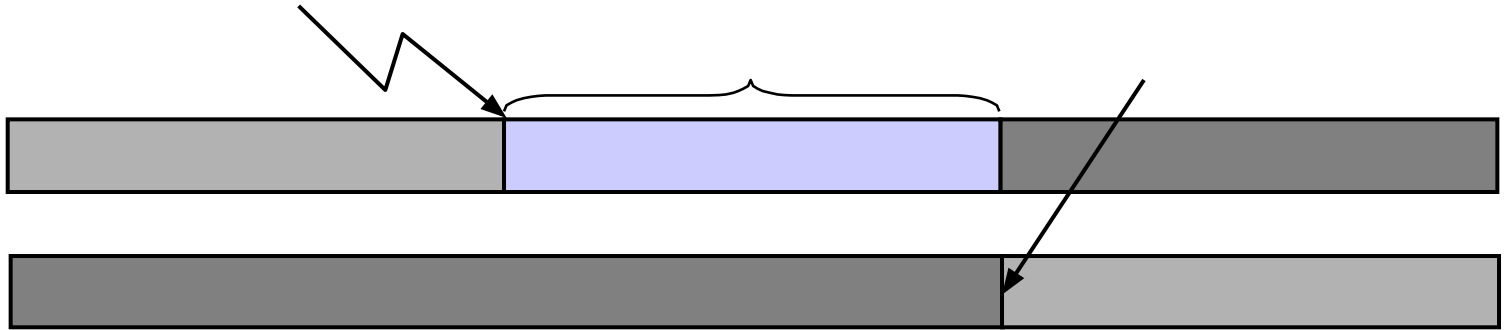

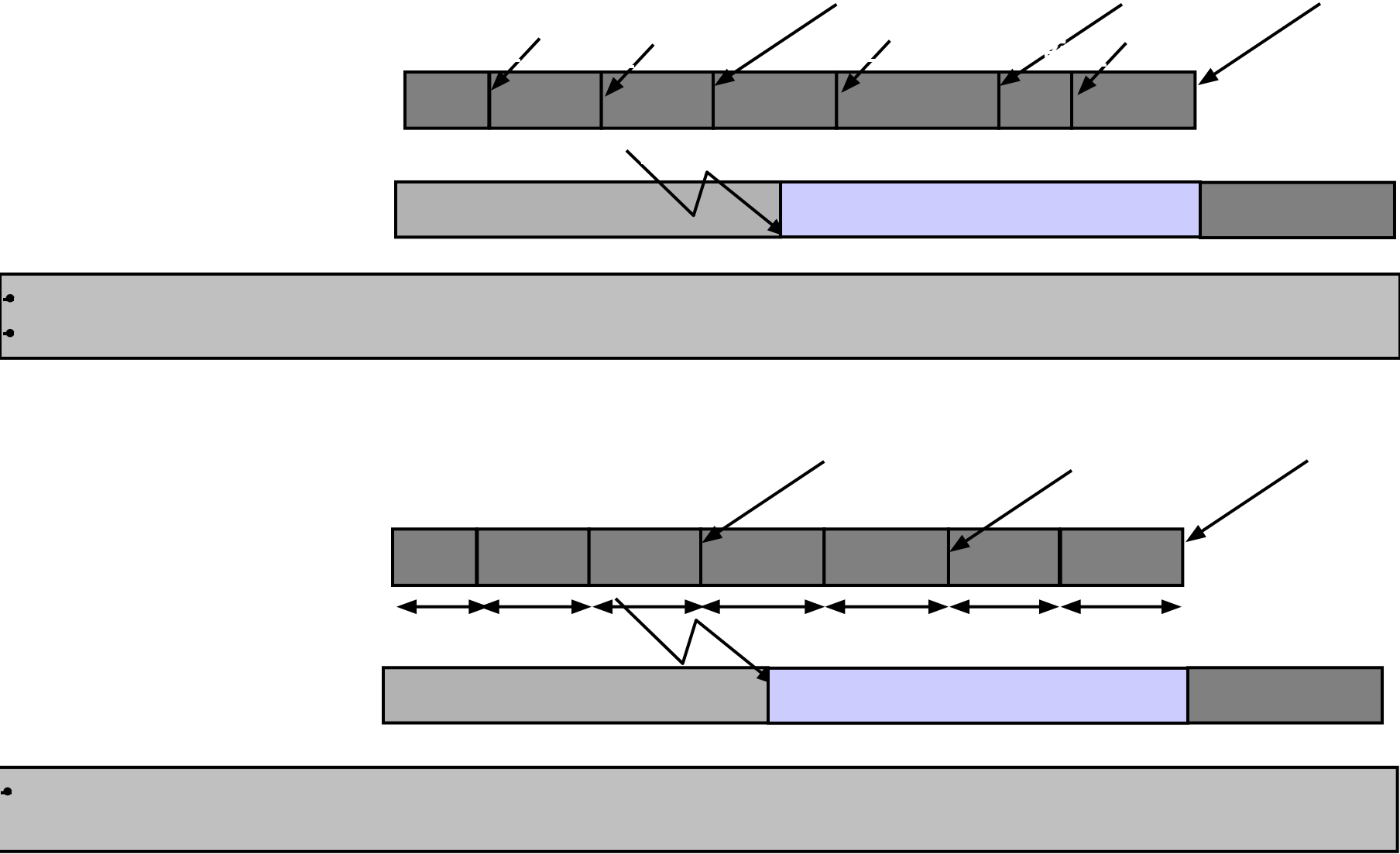

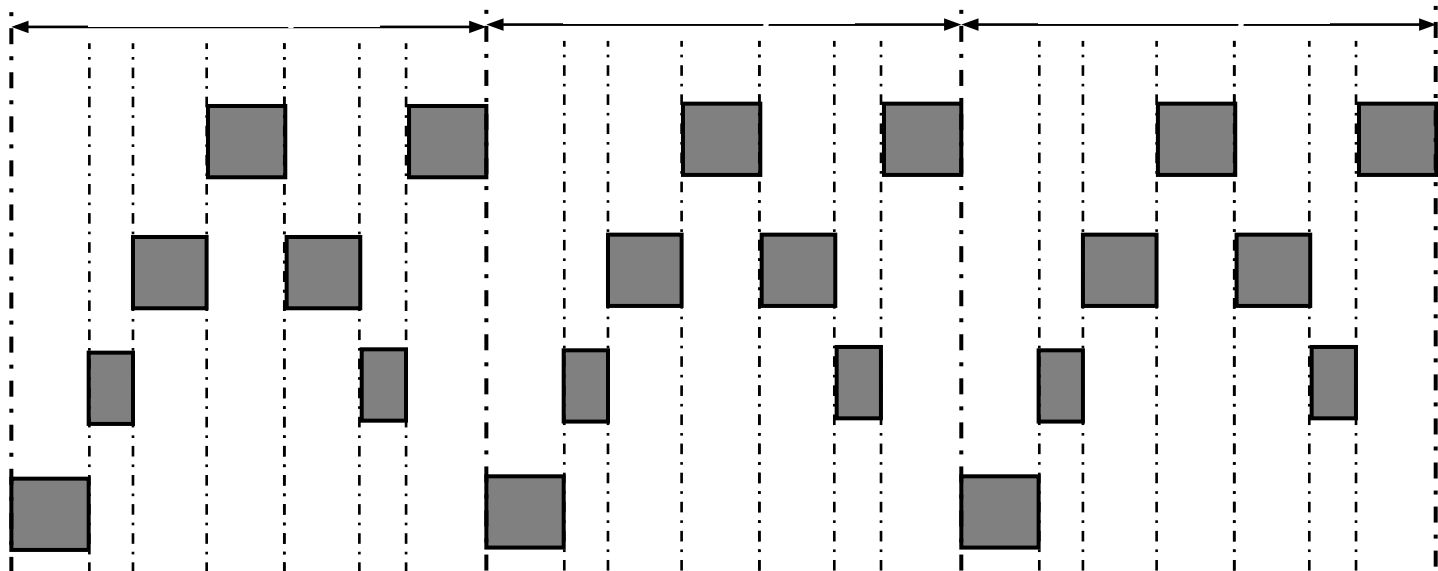



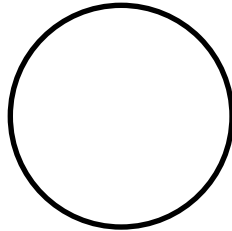
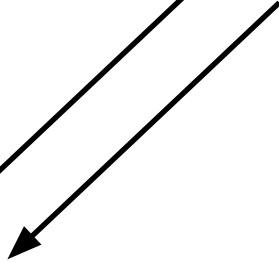
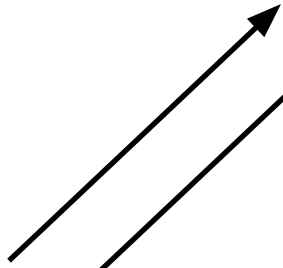
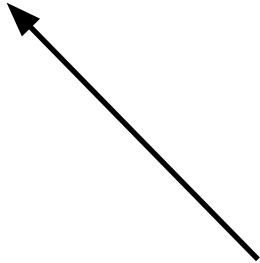
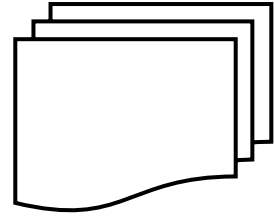
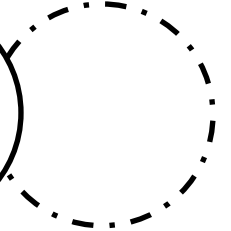
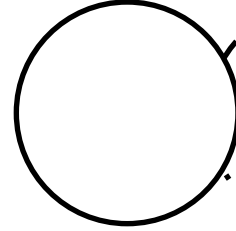
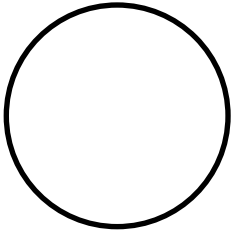
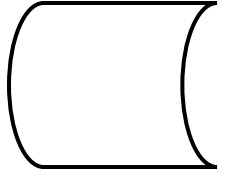
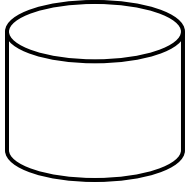

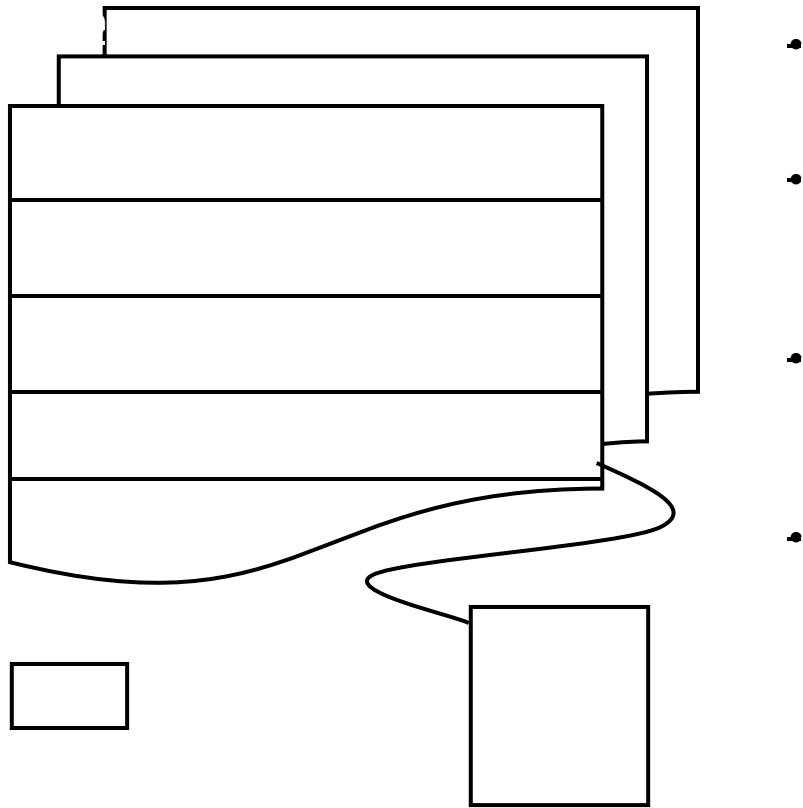

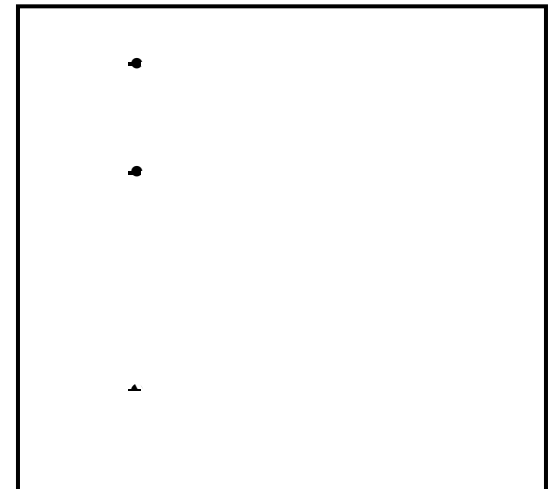
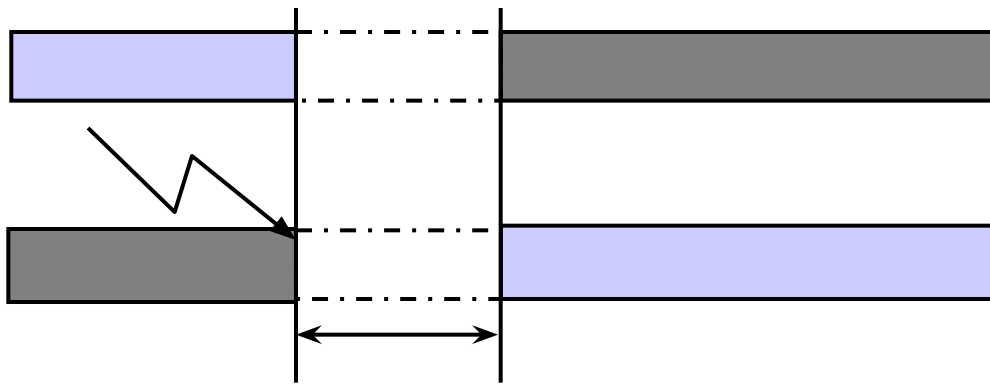
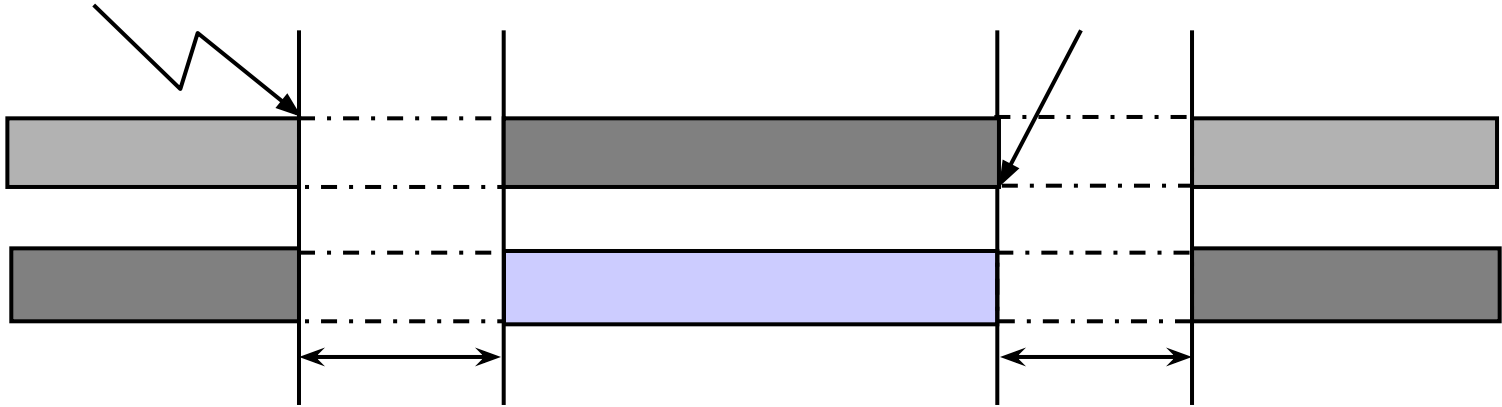

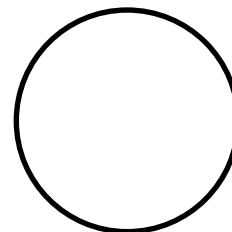
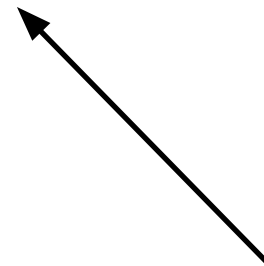
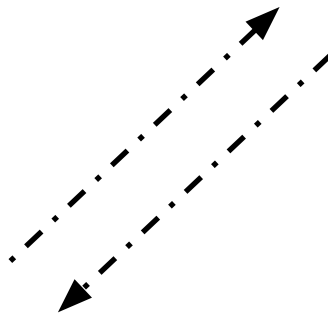
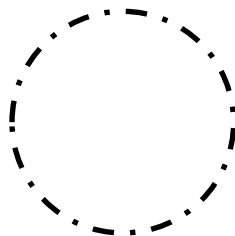
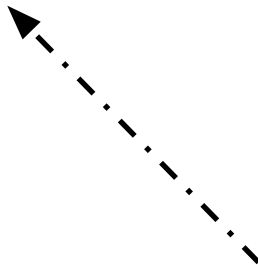
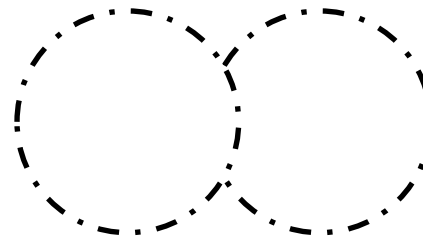
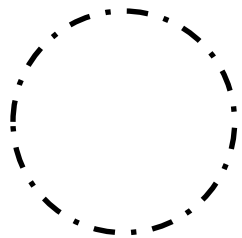

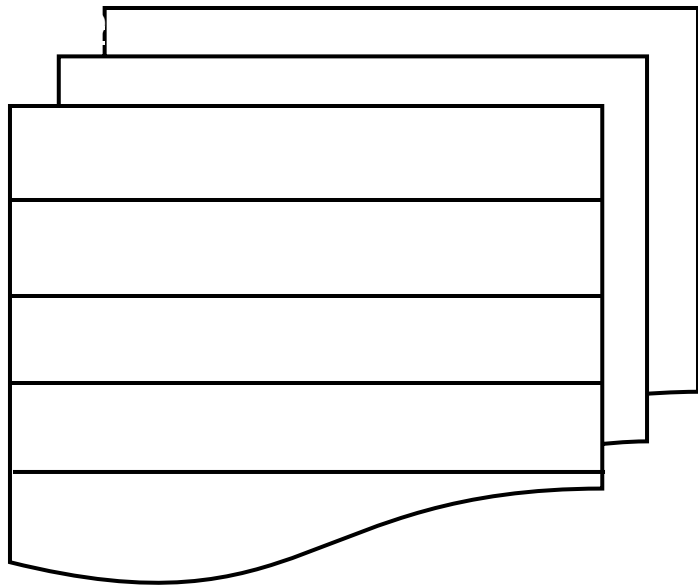

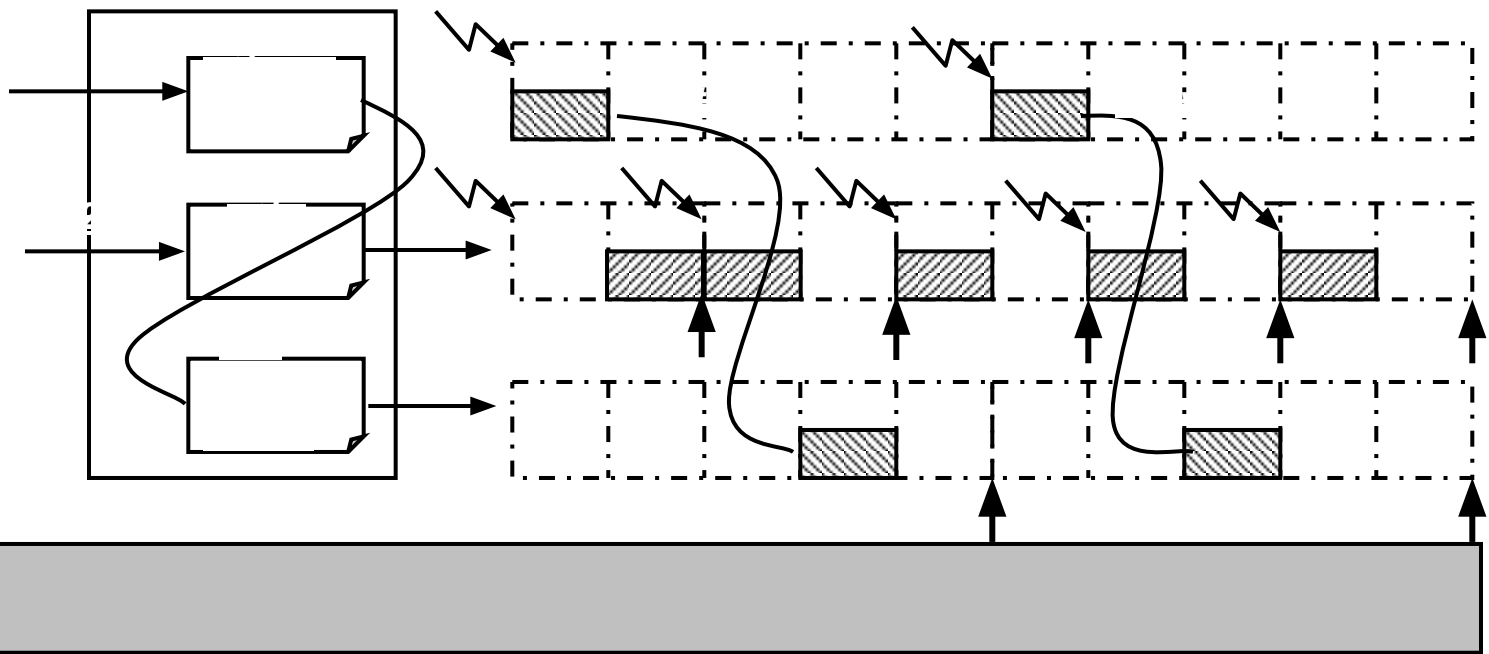
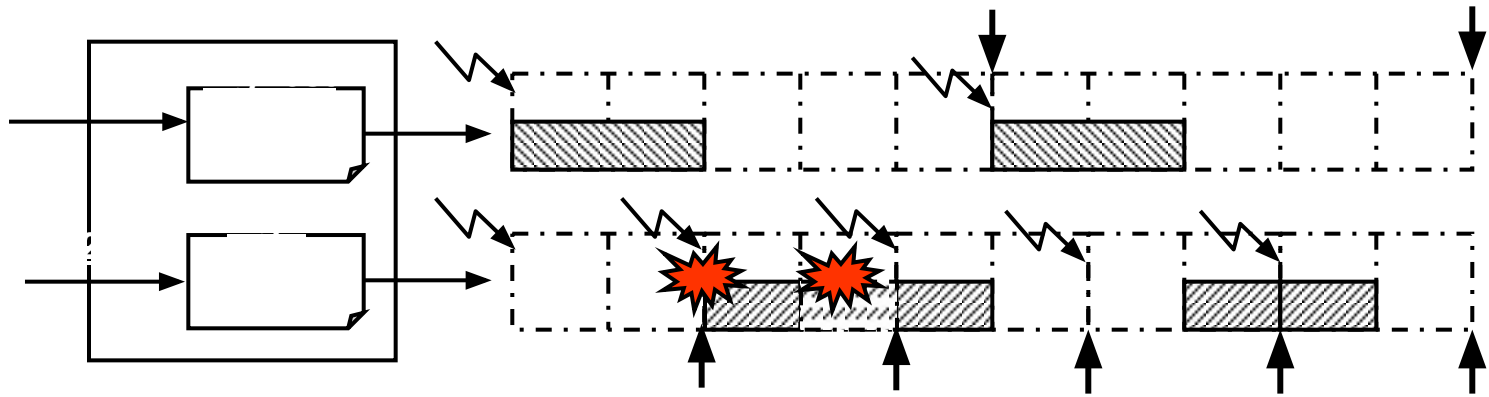

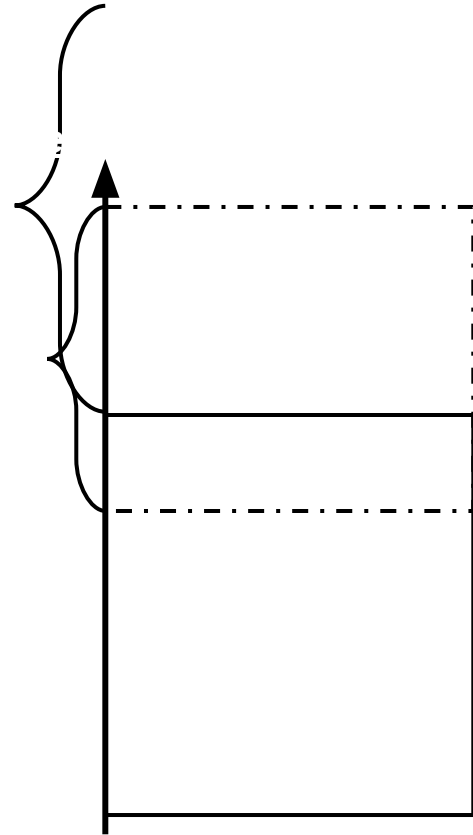
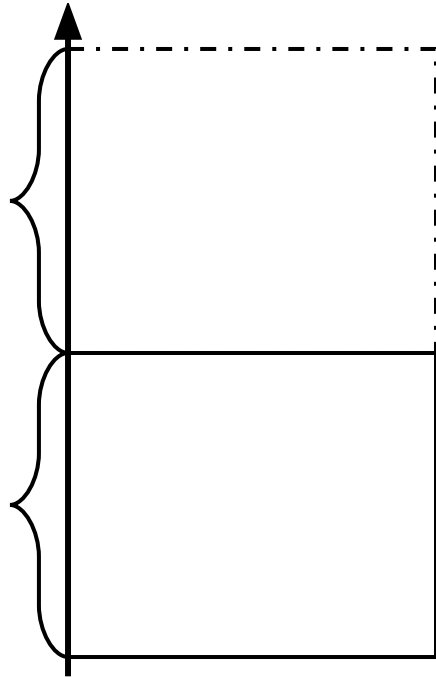



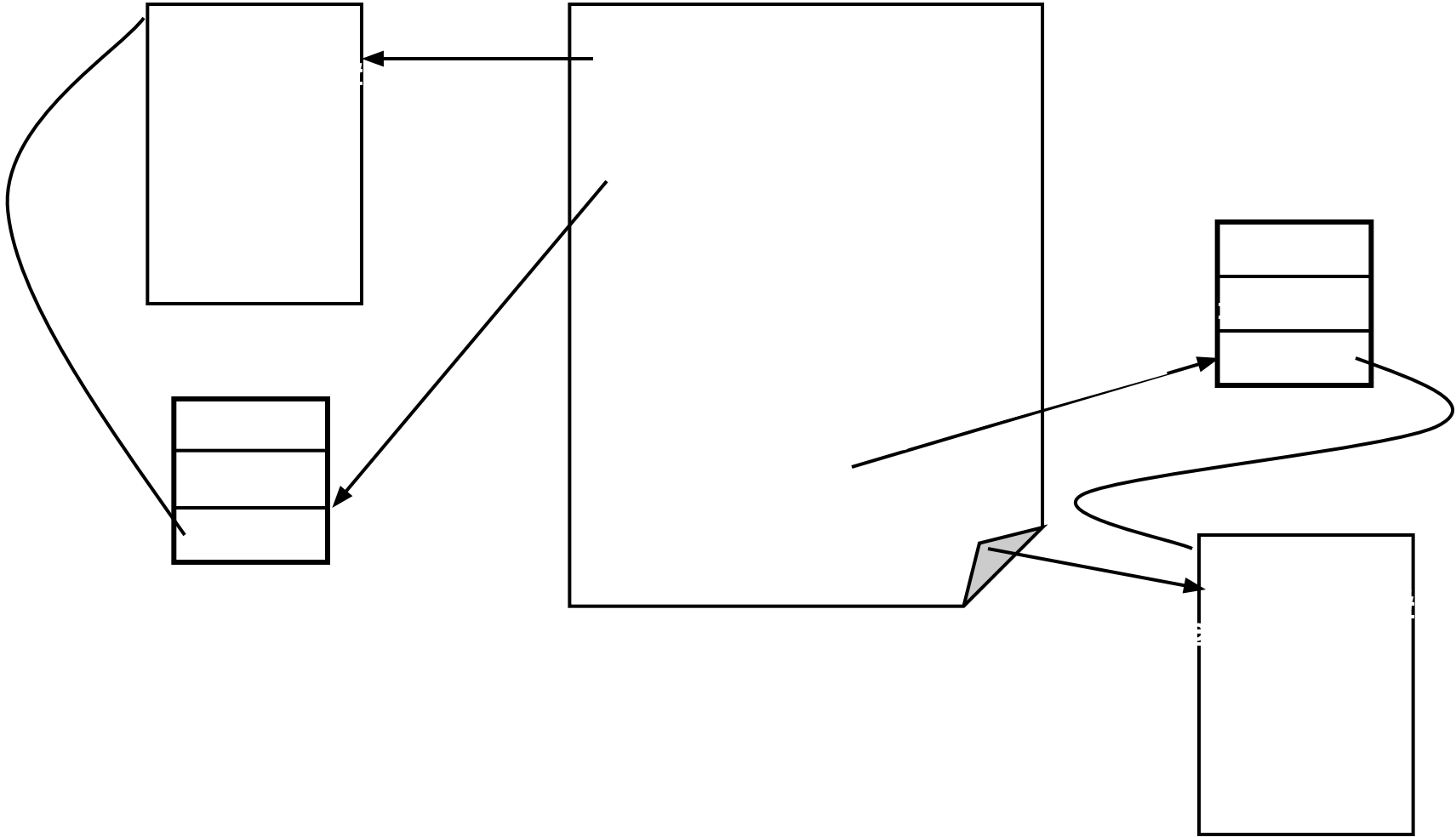

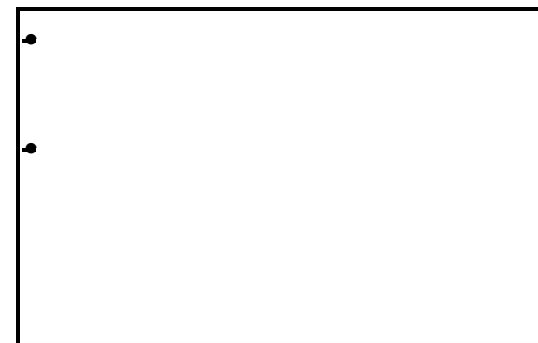
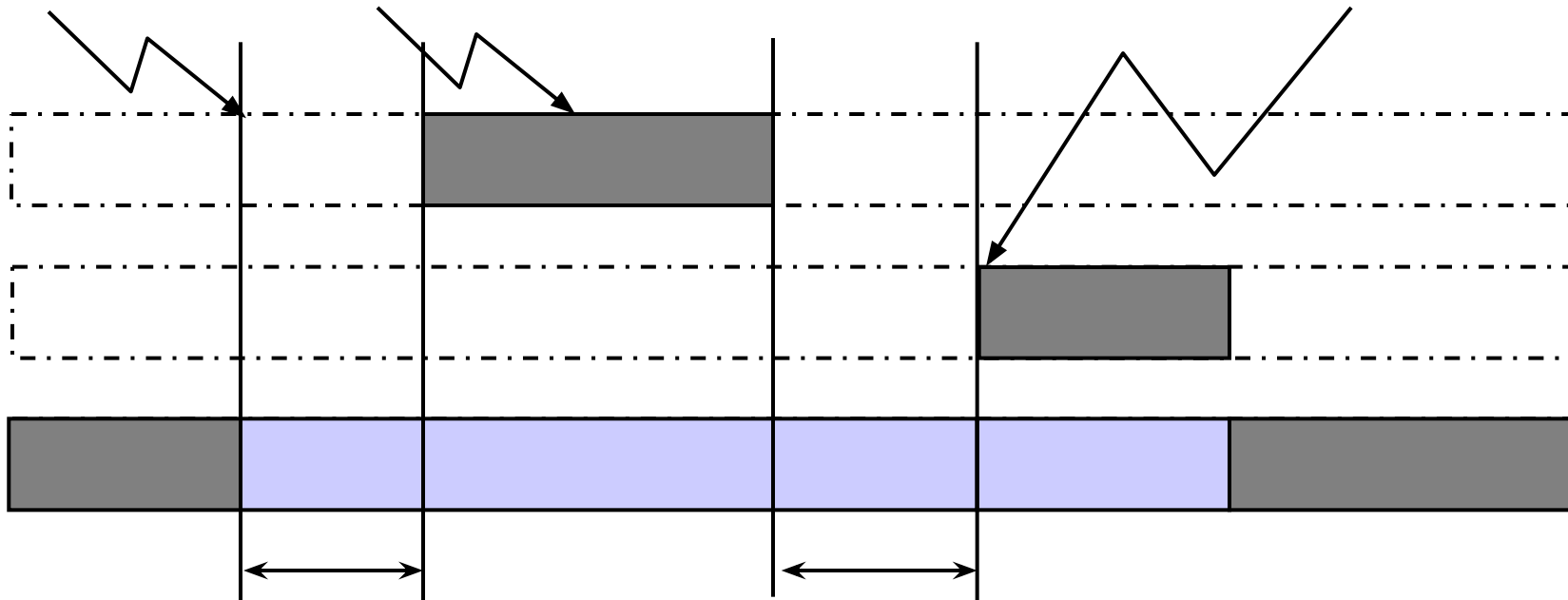

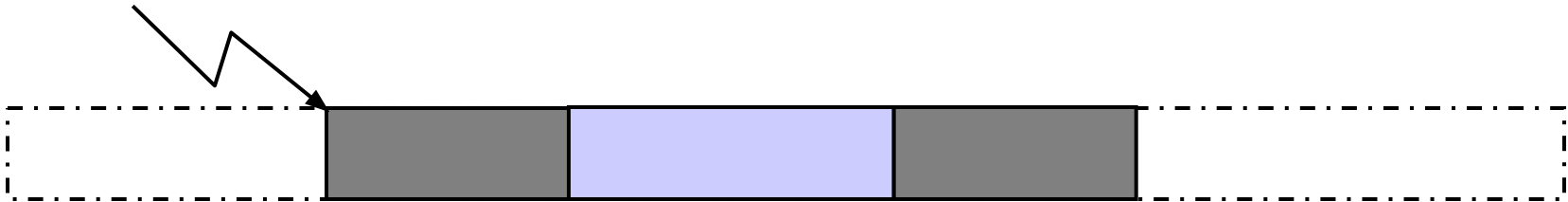

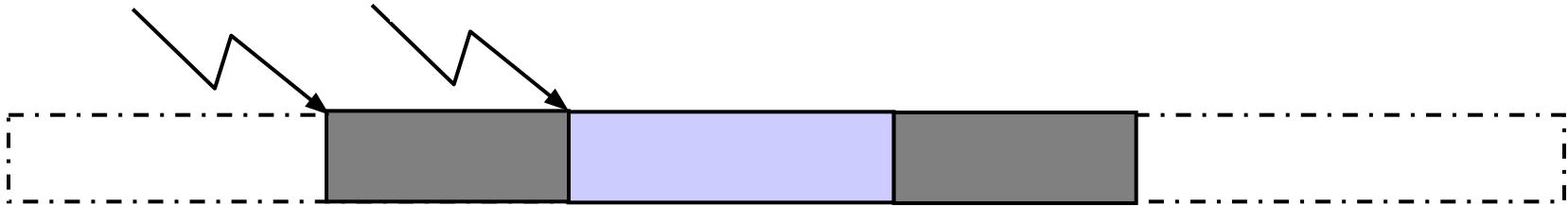

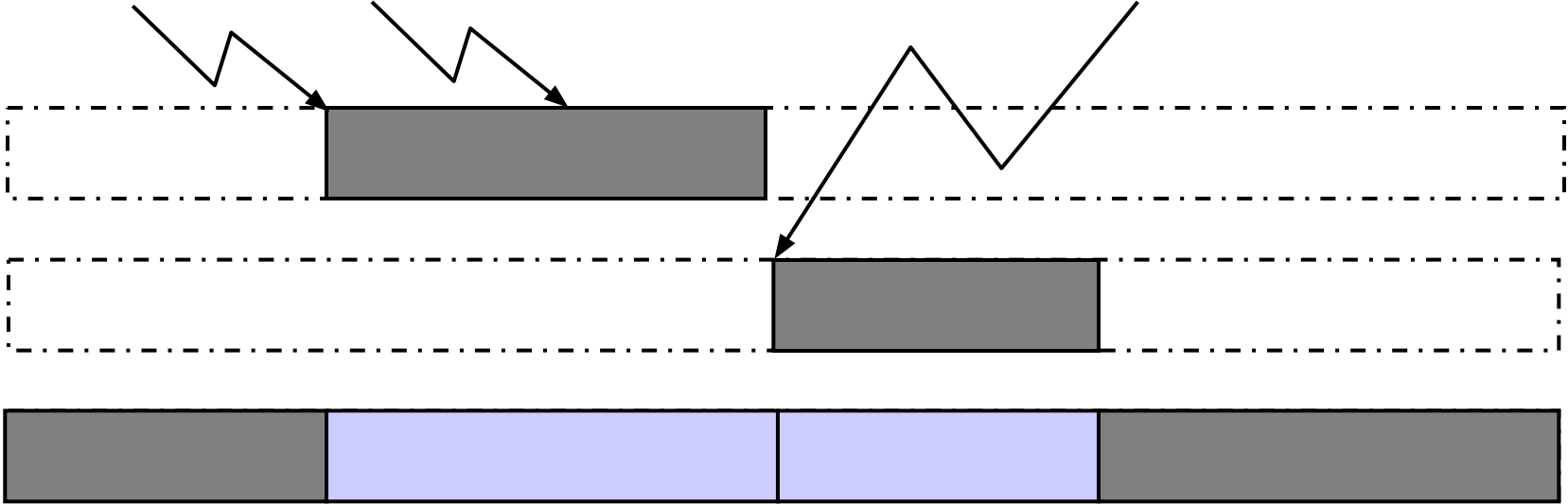

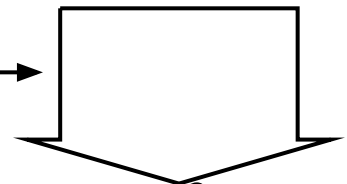
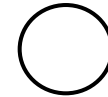
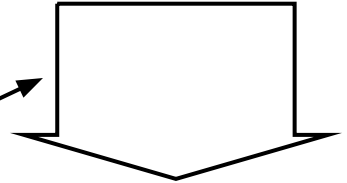
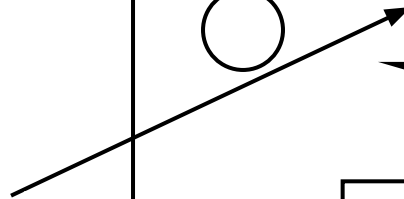
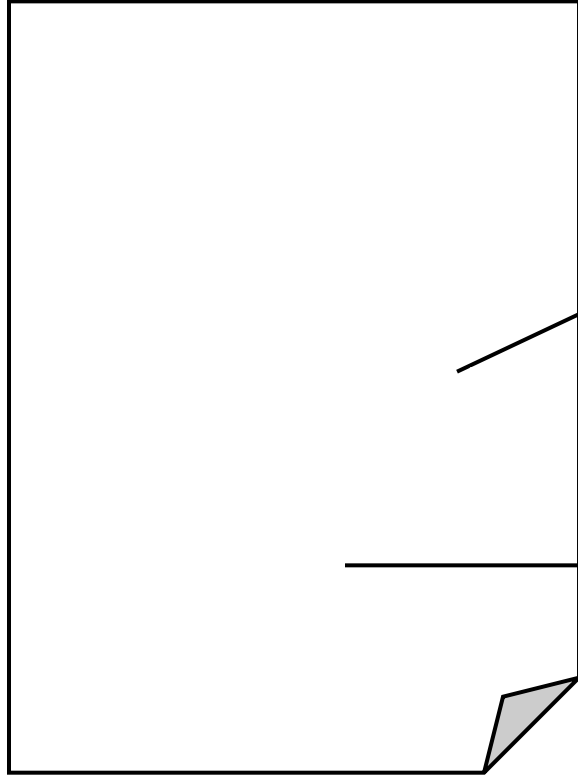
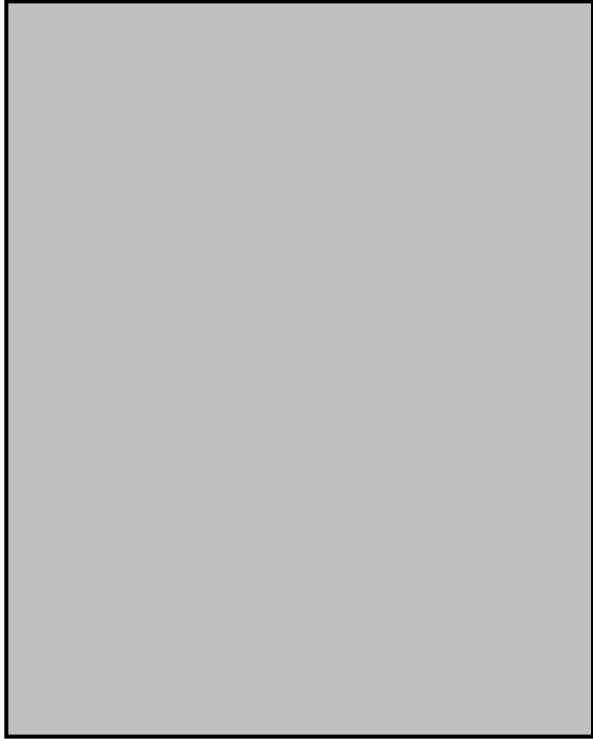

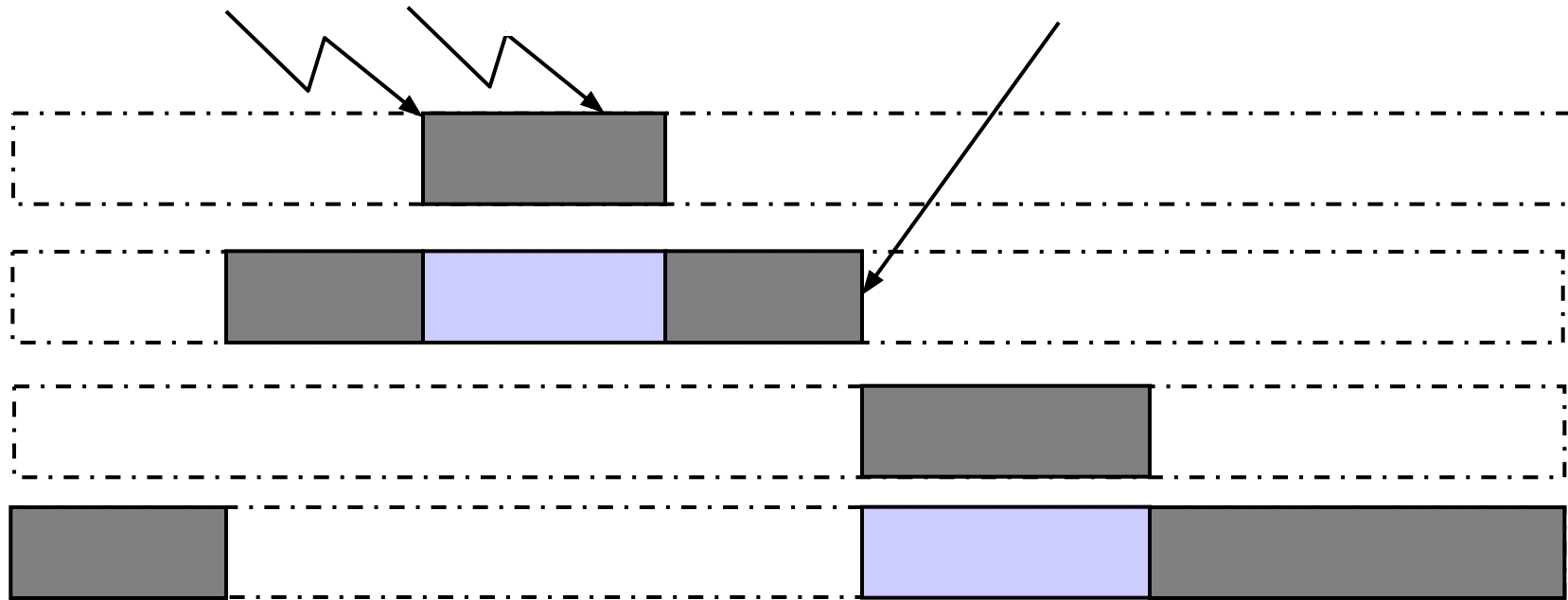

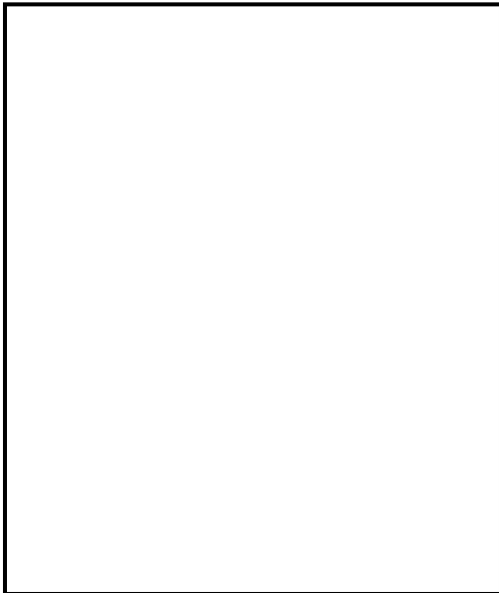

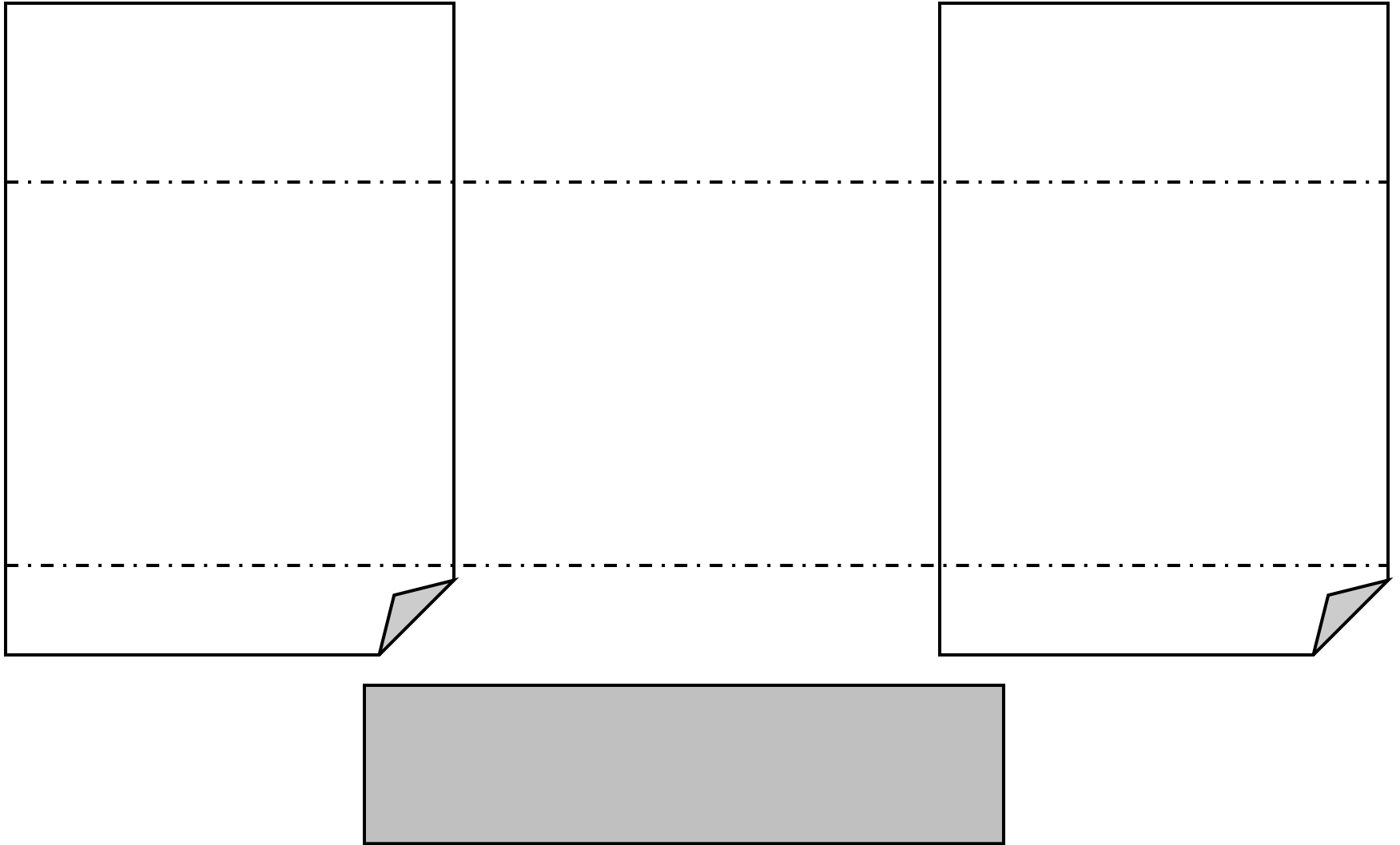

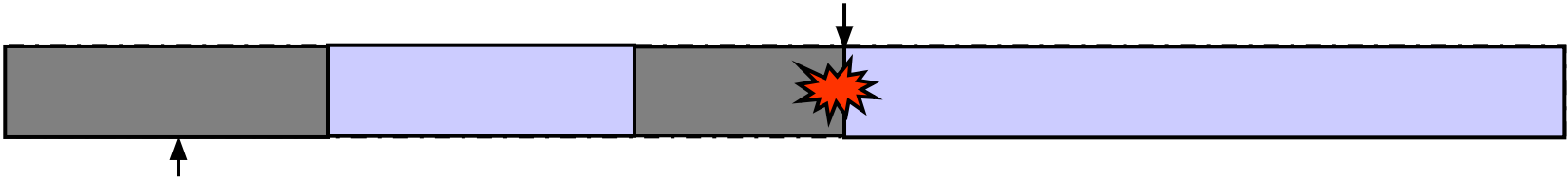
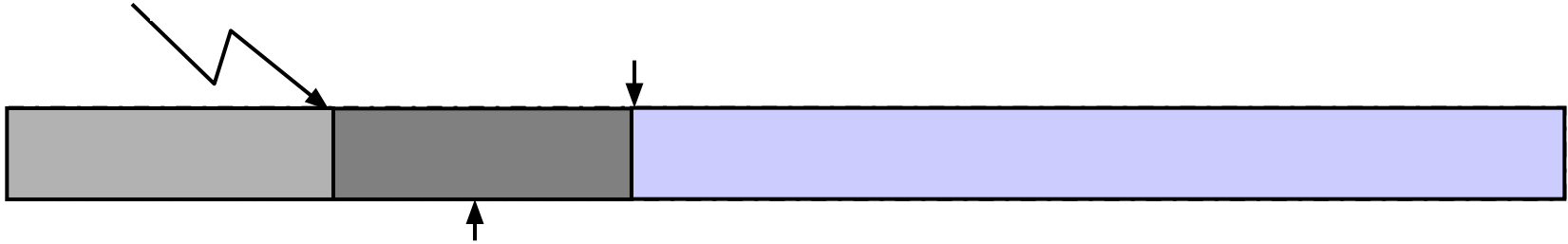

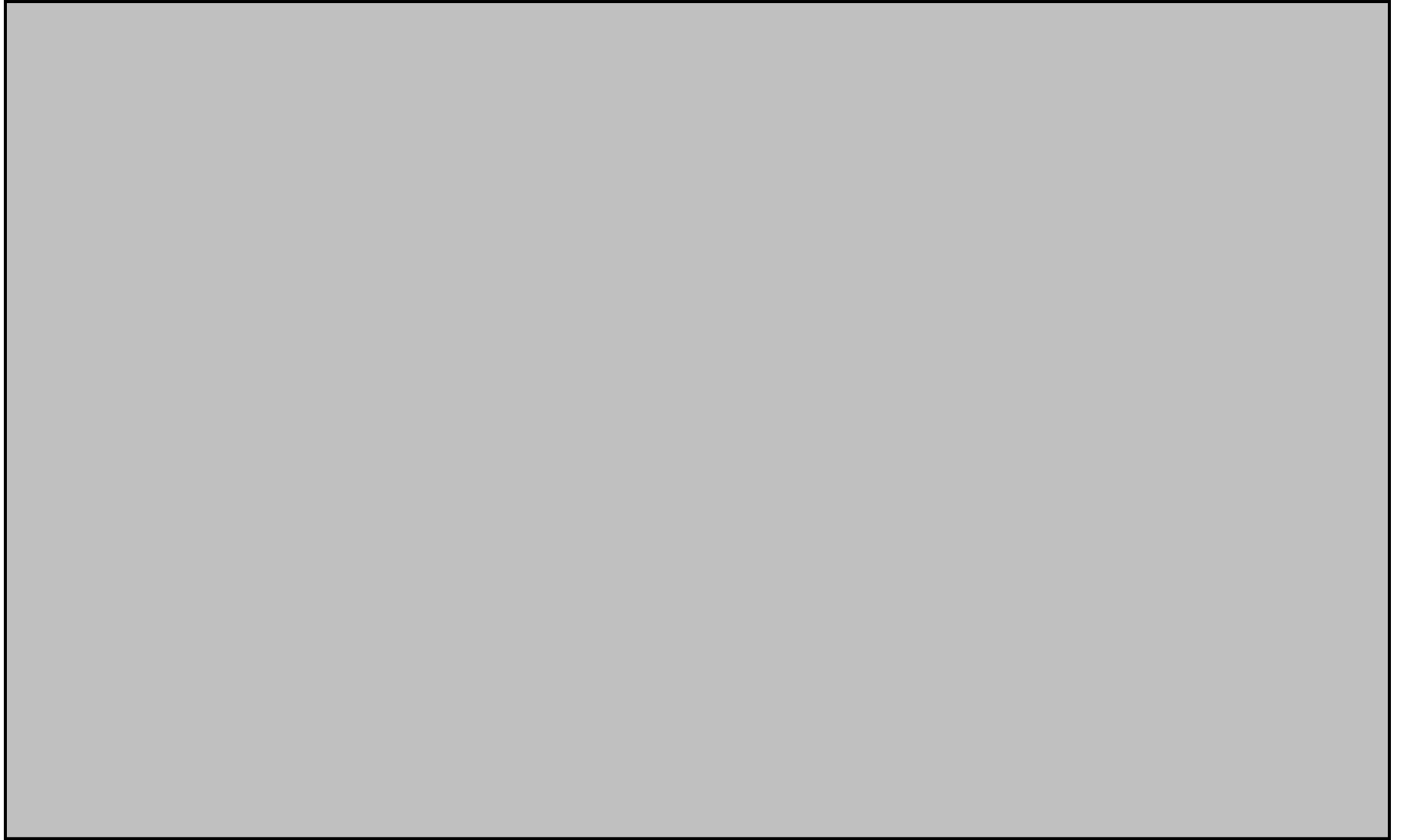

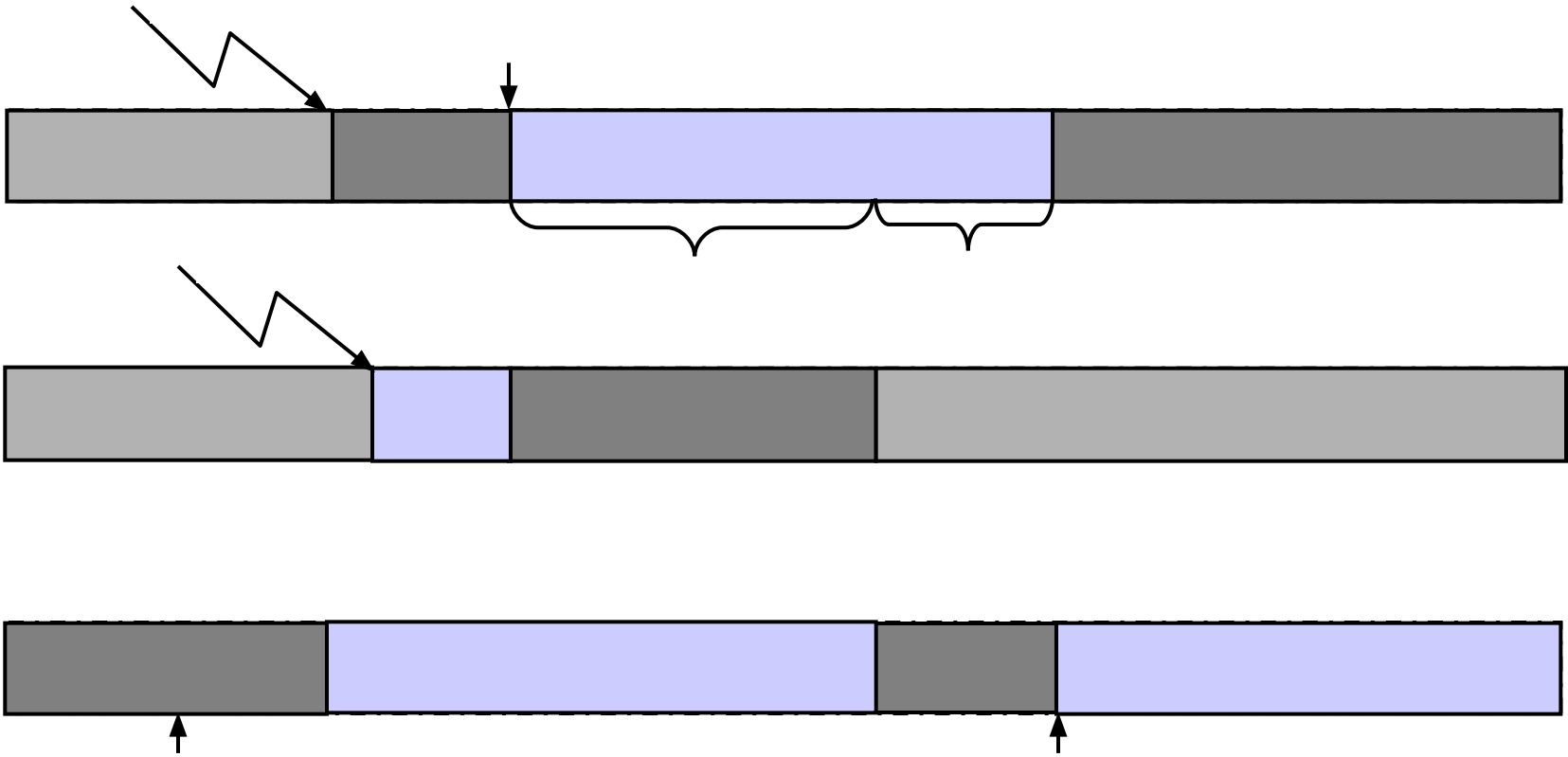



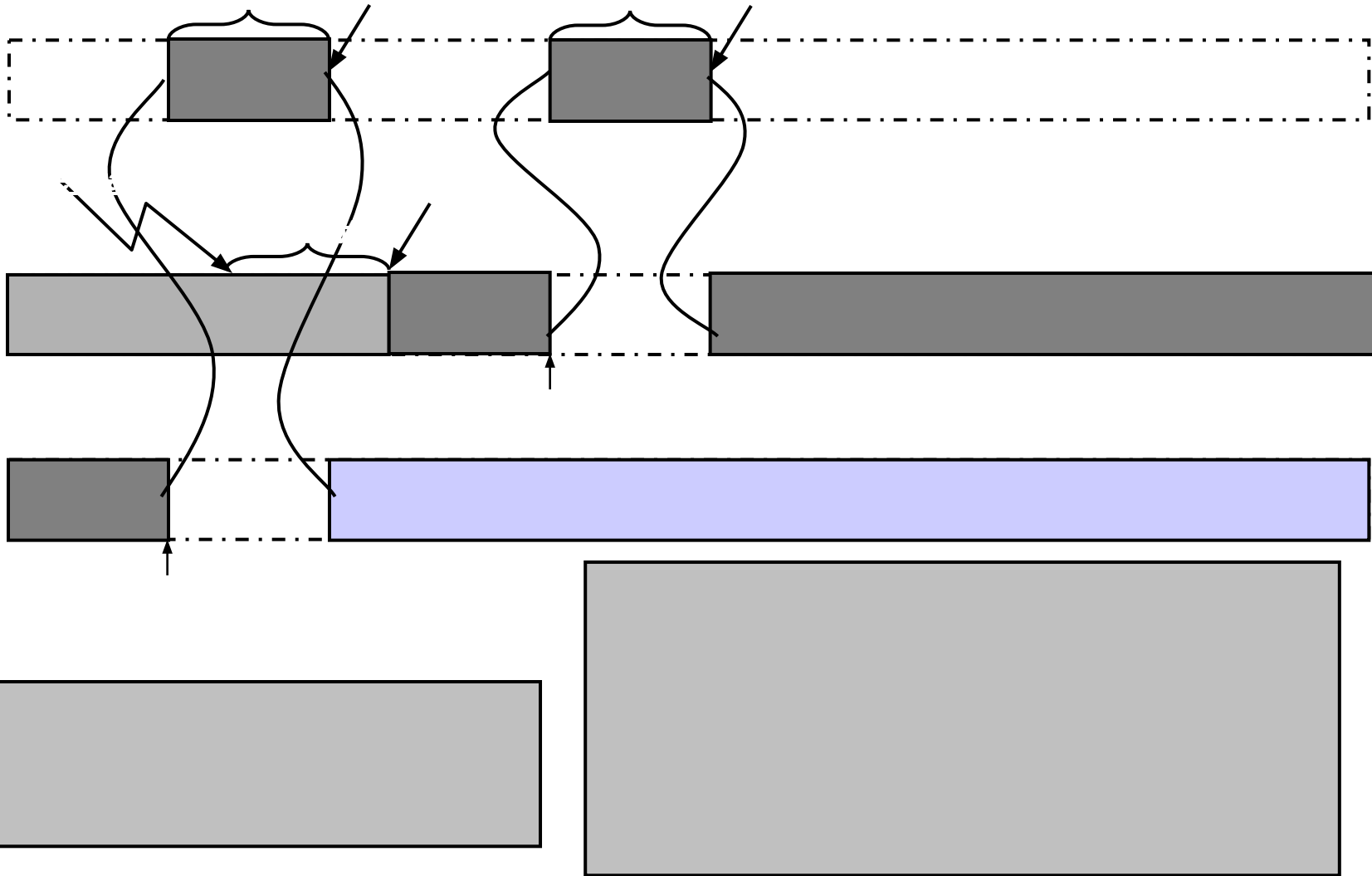

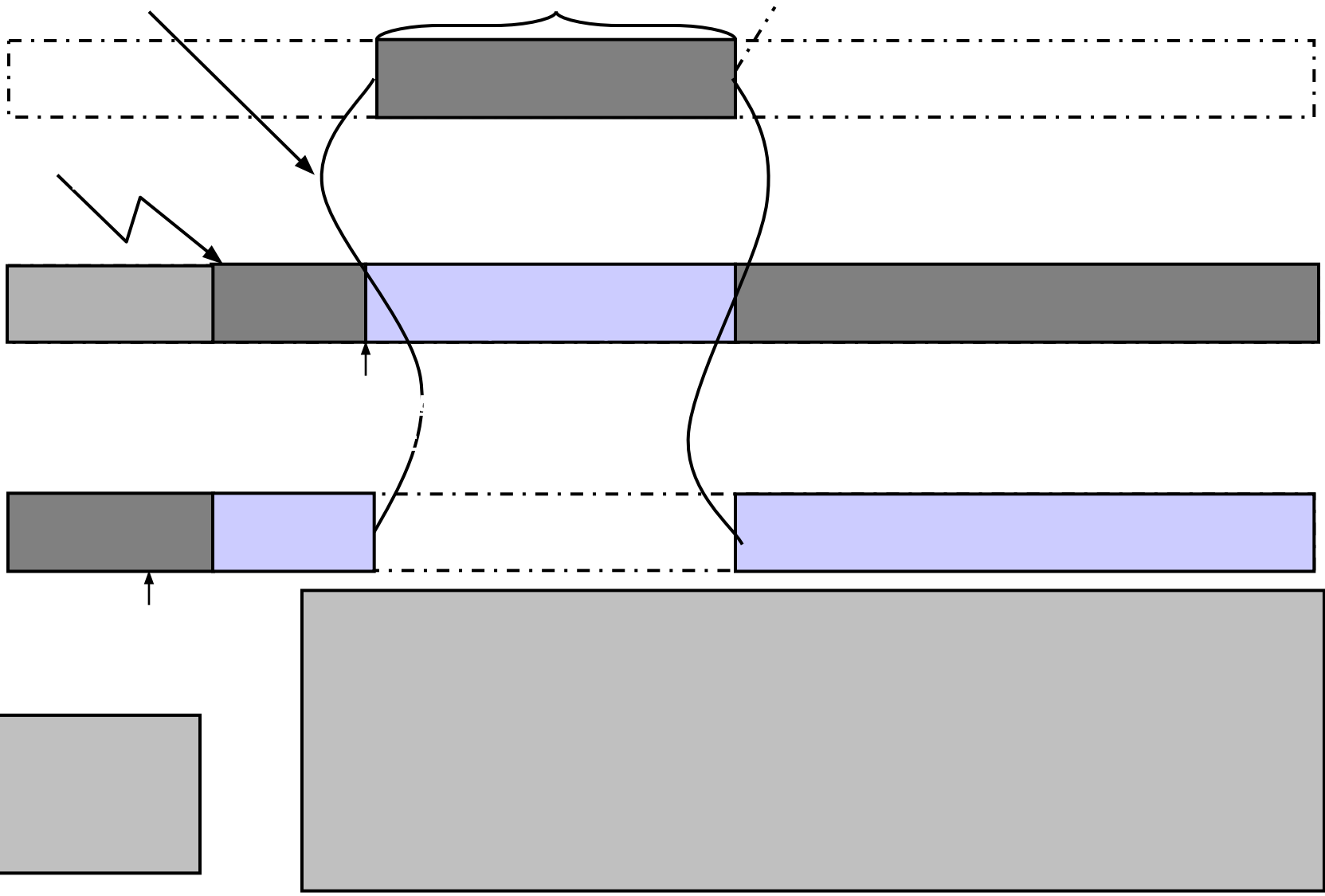

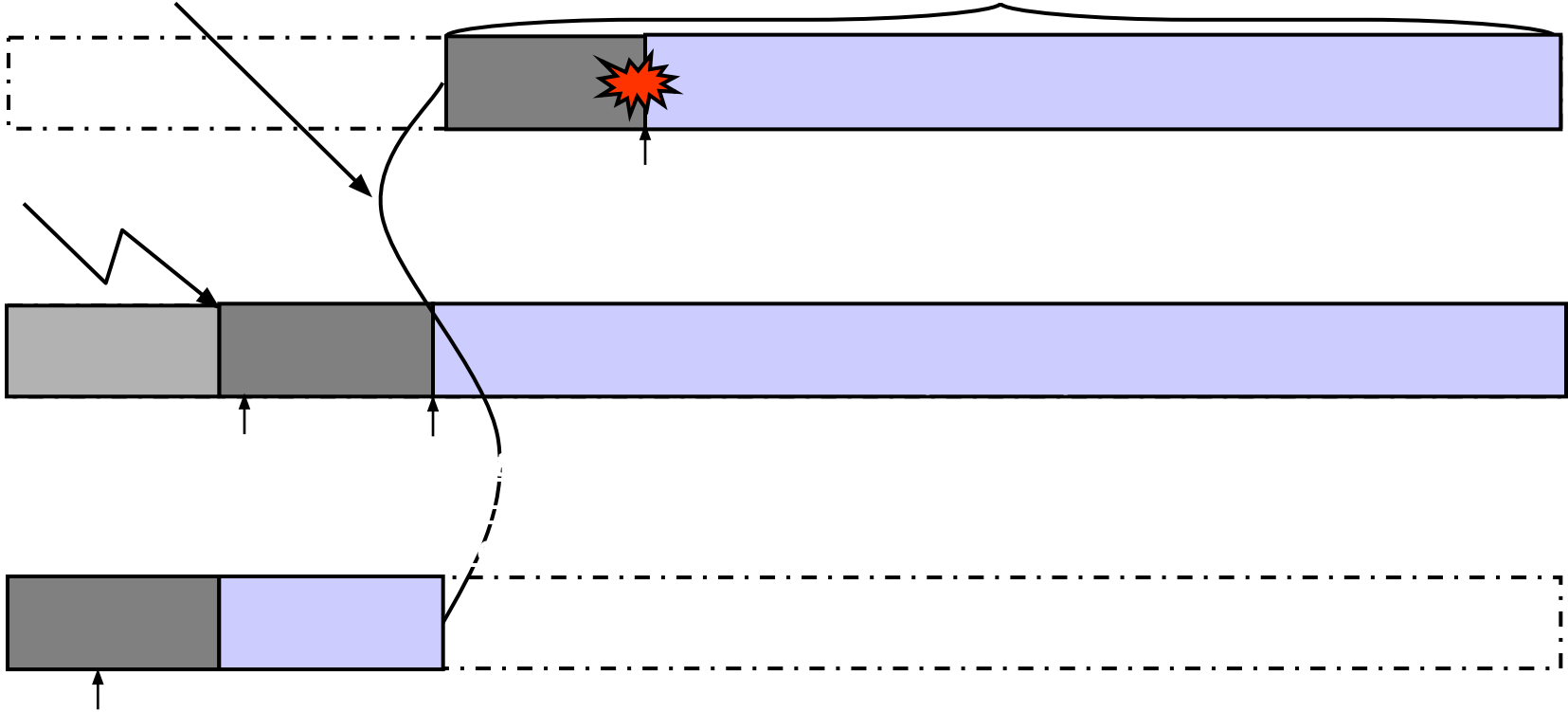

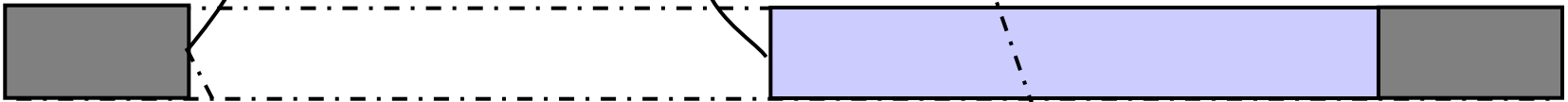
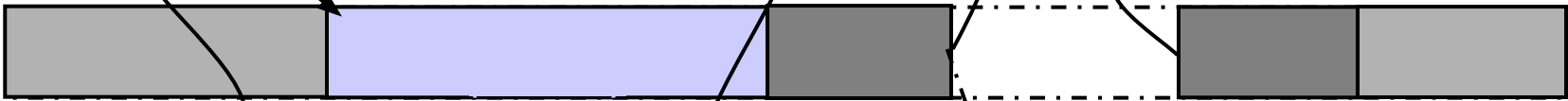
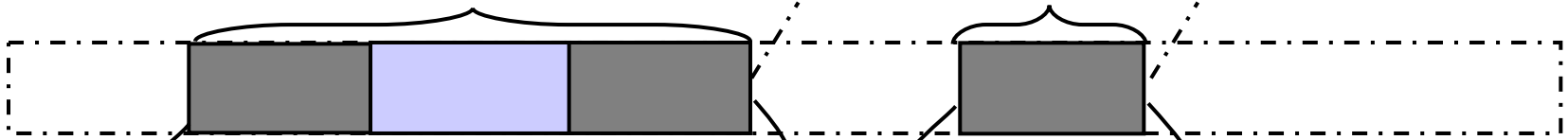

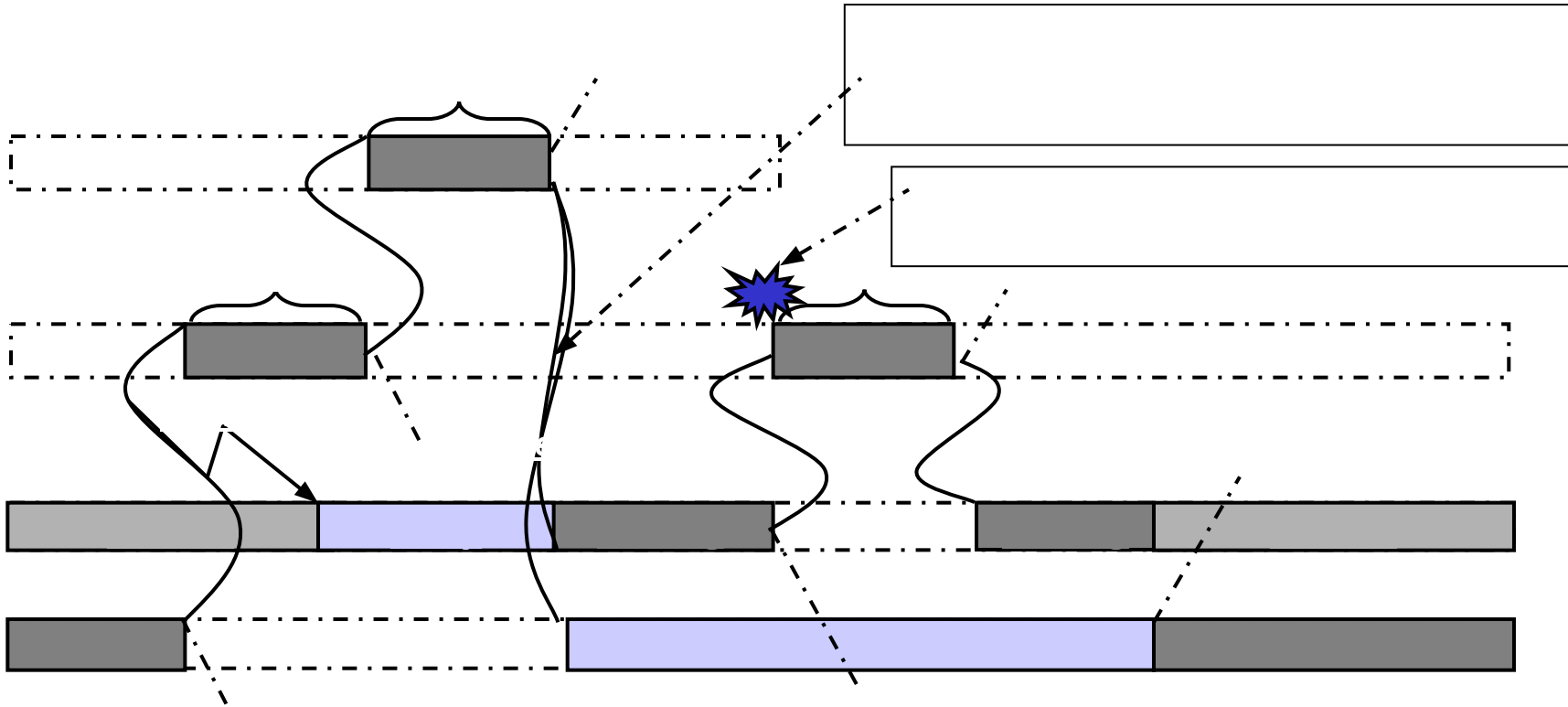

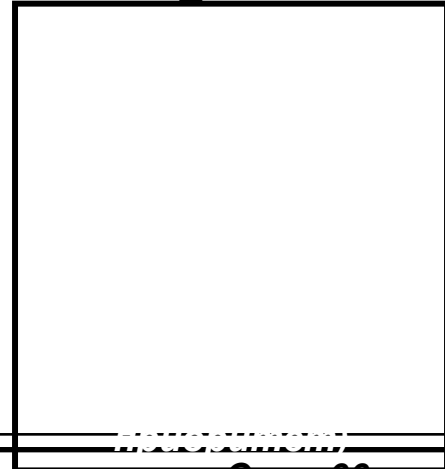

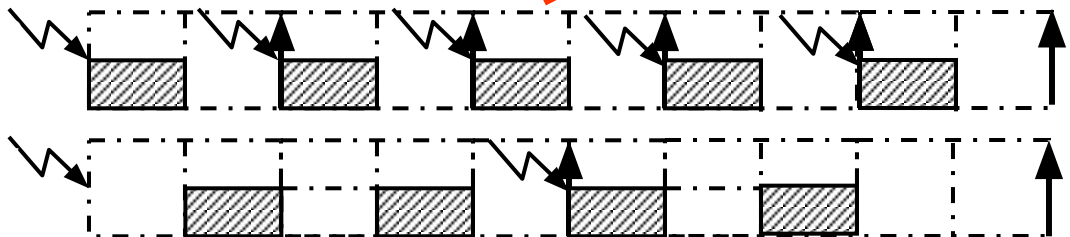
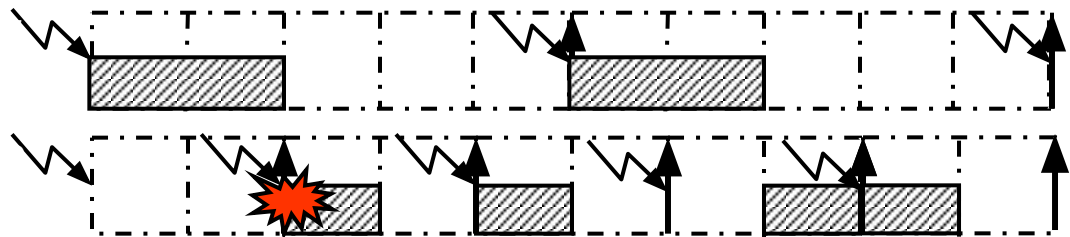
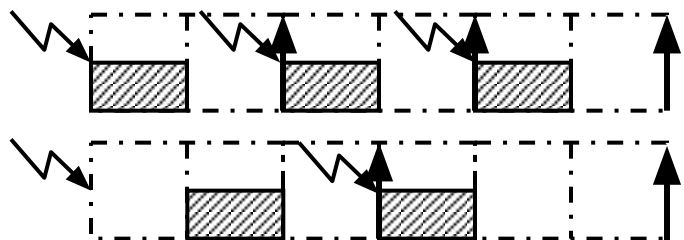
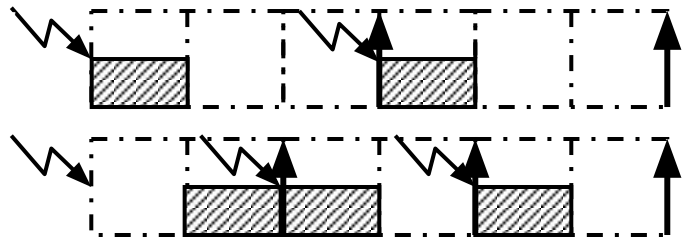

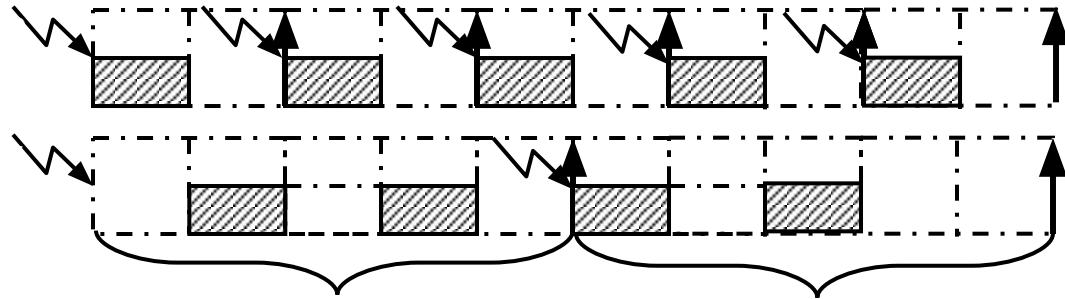
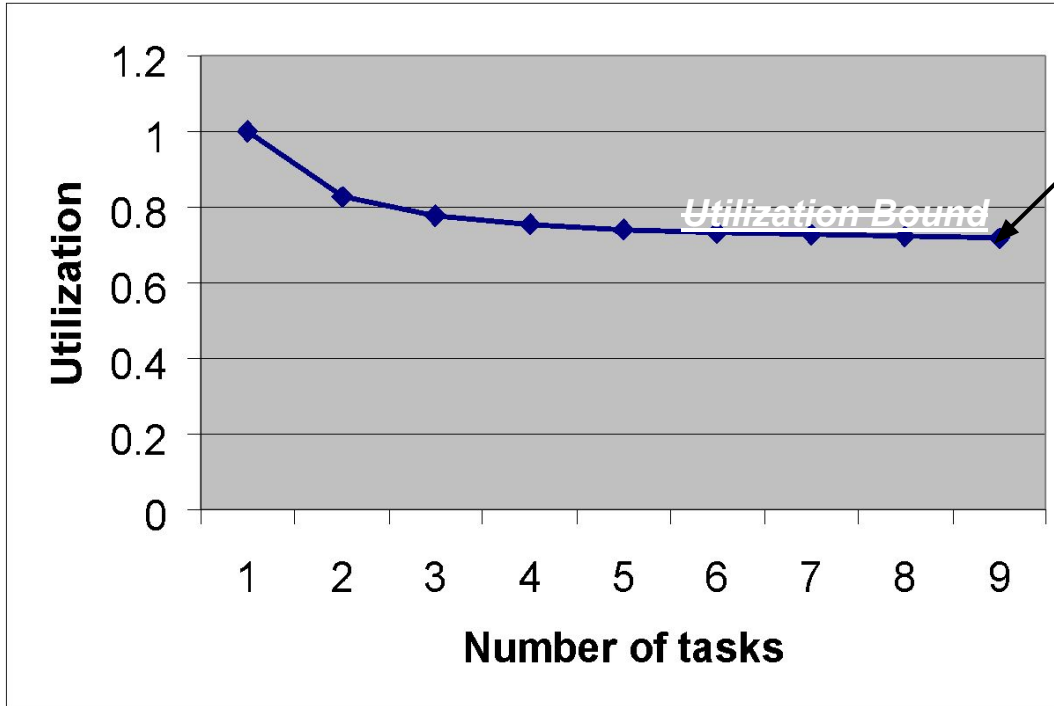

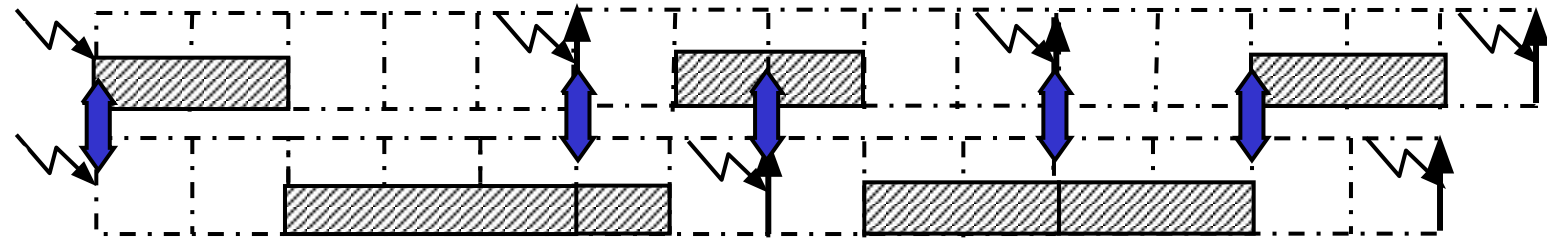
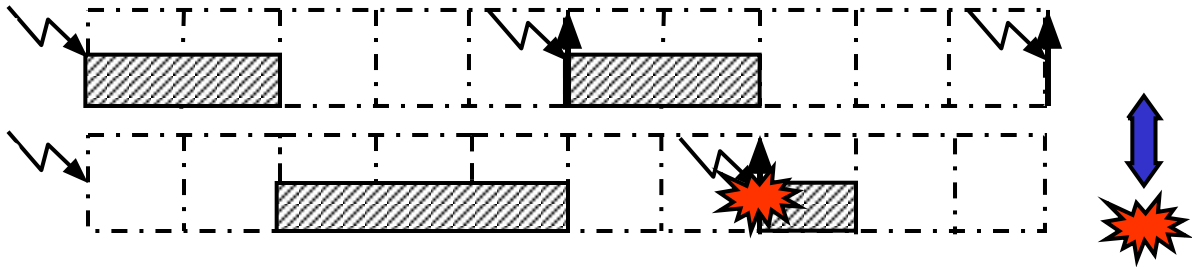

$t_0: T_0=D_0=2, C_1=1; t_1: T_1=D_1=10, C_1=2; t_2: T_2=D_2=14, C_2=4; U=1/2+2/10+4/14=0.9857$
 (+) более полное использование процессора

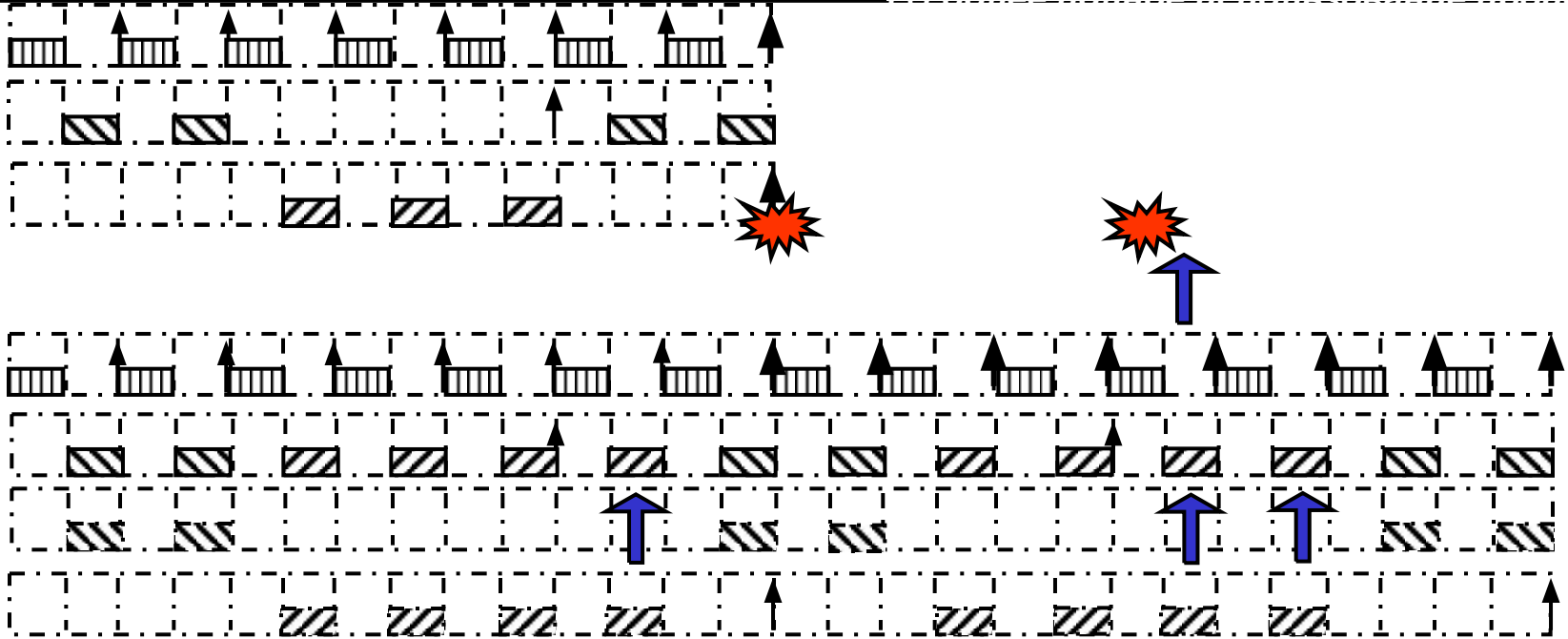

— CAN high speed (250 kbit)
— CAN low speed (125 kbit)

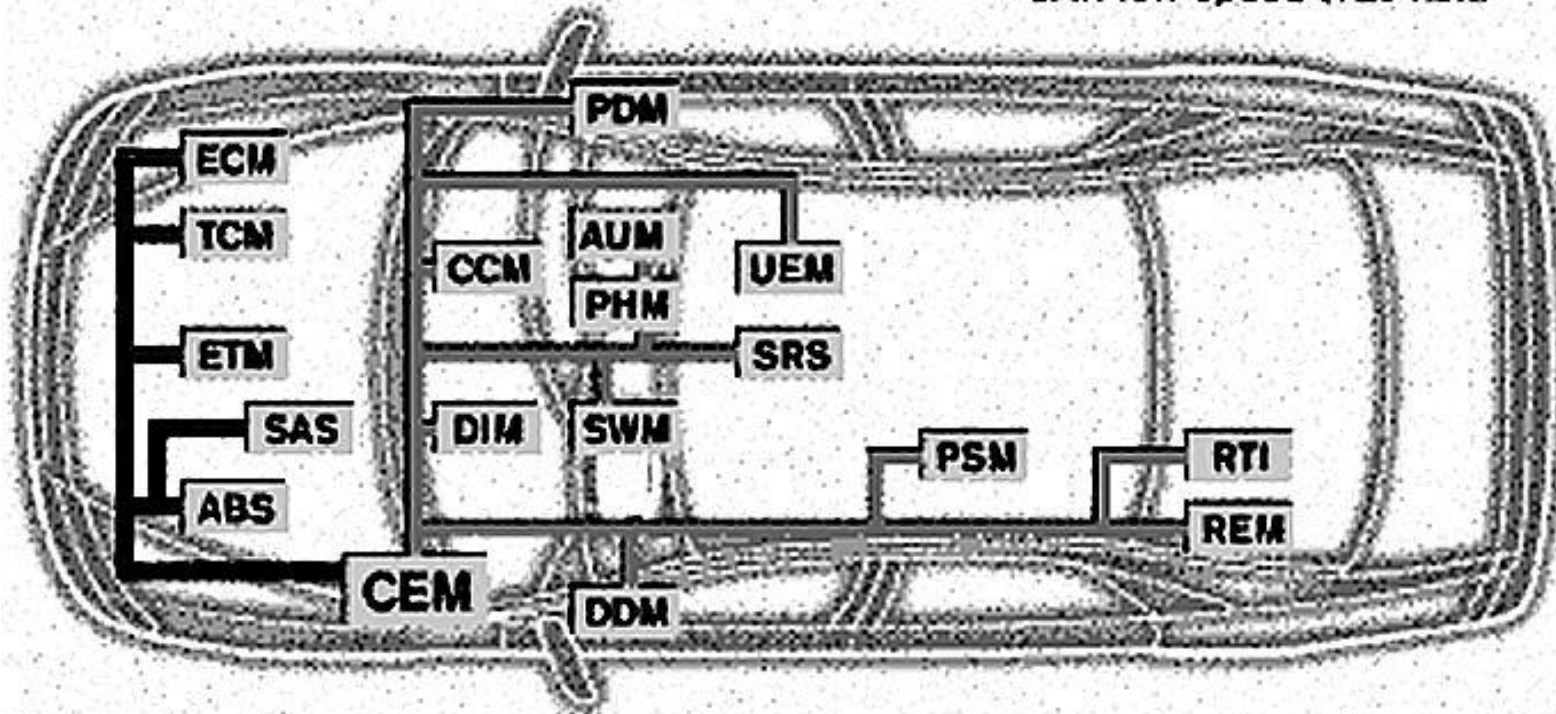

Полная версия: <http://www.tech2-volvo.se/reportage/0811/electrical/main.htm>

