

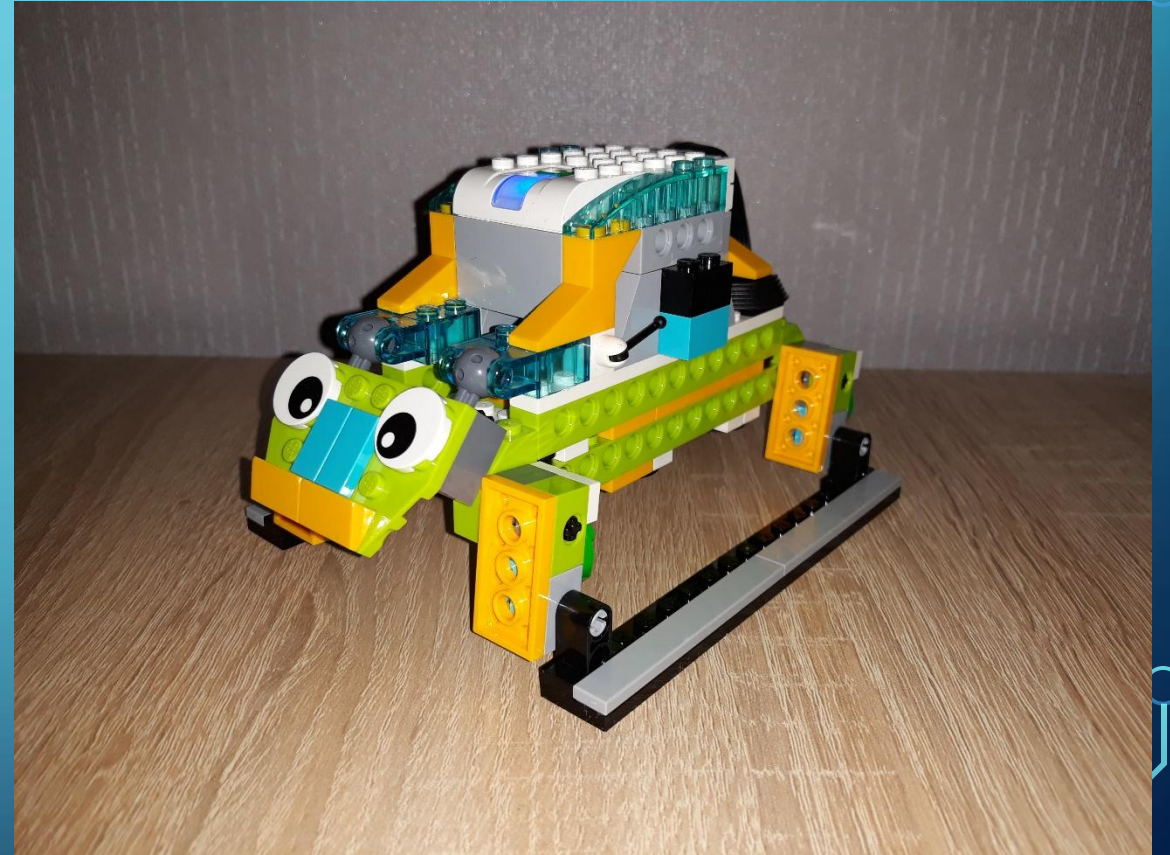

ИНСТРУКЦИЯ ПО СБОРКЕ ДЛЯ НАБОРА WEDO 2.0

«ЖУК»

WEDO 2.0 «ЖУК»

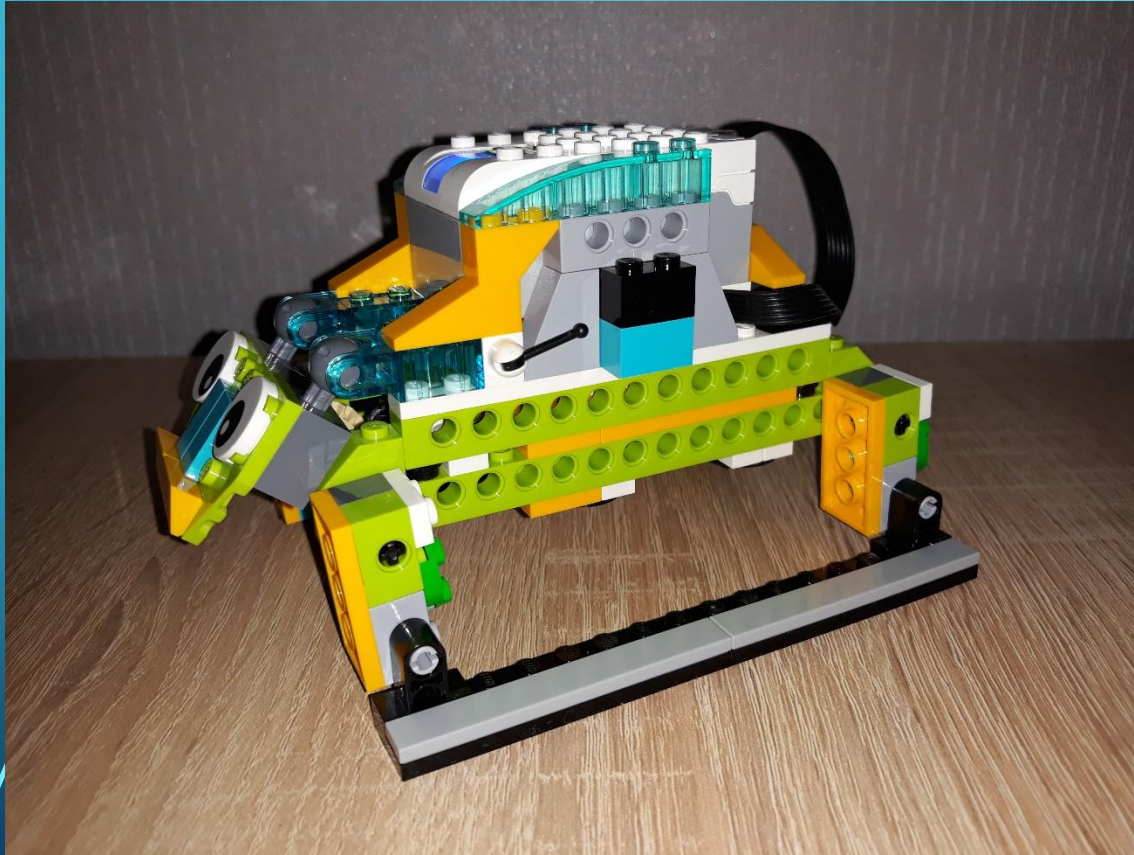

WEDO 2.0 «ЖУК»

1

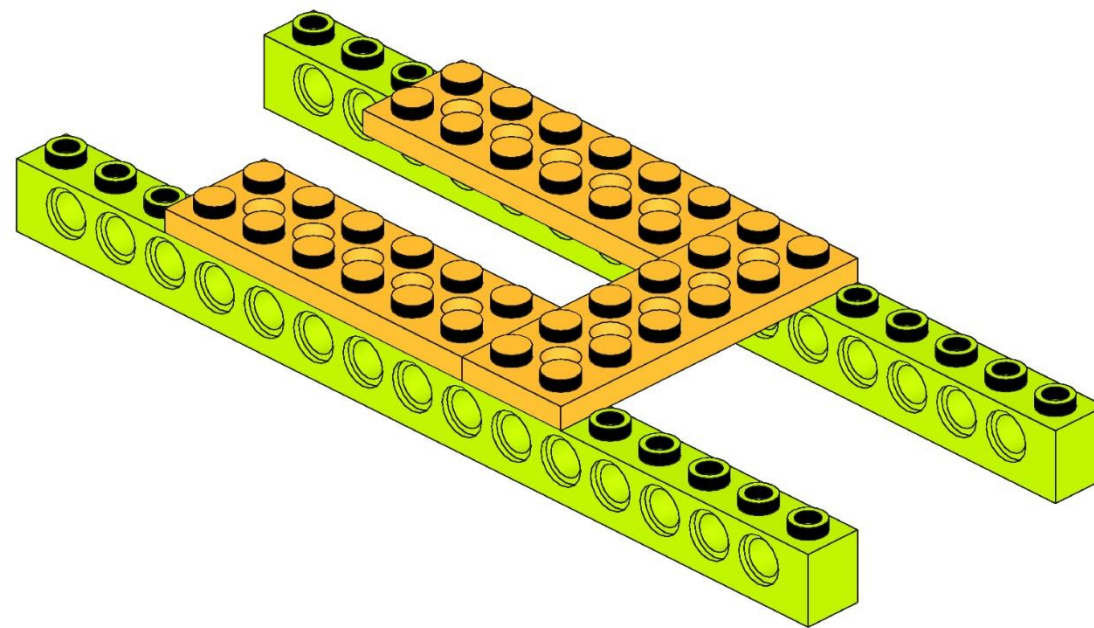
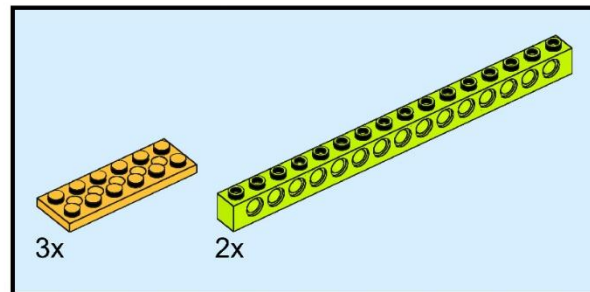

WEDO 2.0 «ЖУК»

2

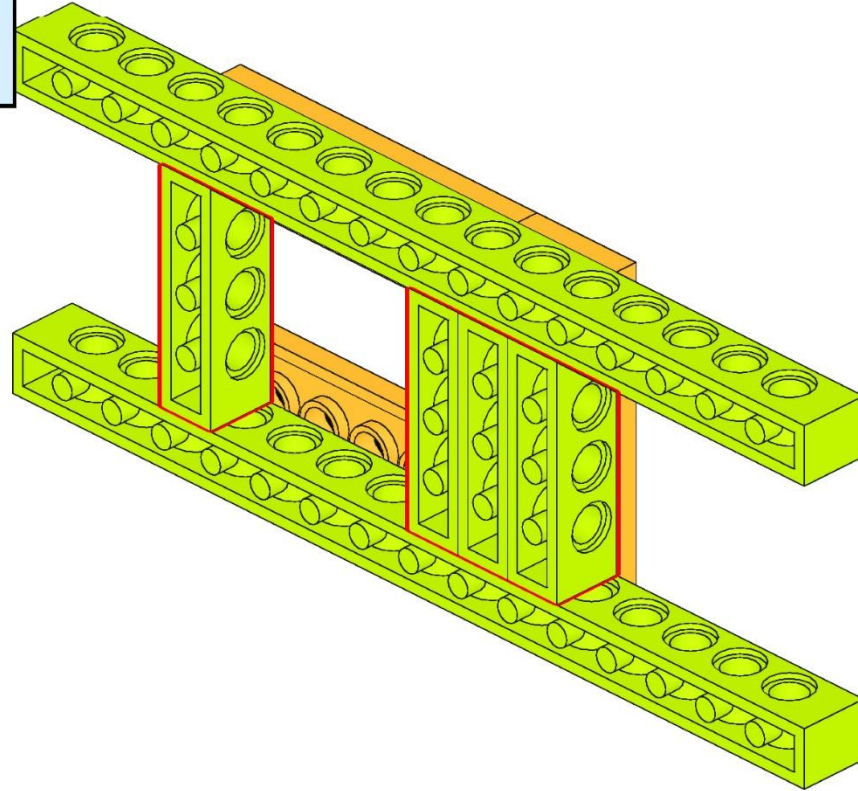
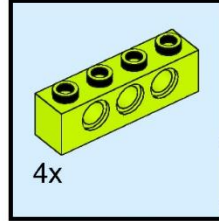

WEDO 2.0 «ЖУК»

3

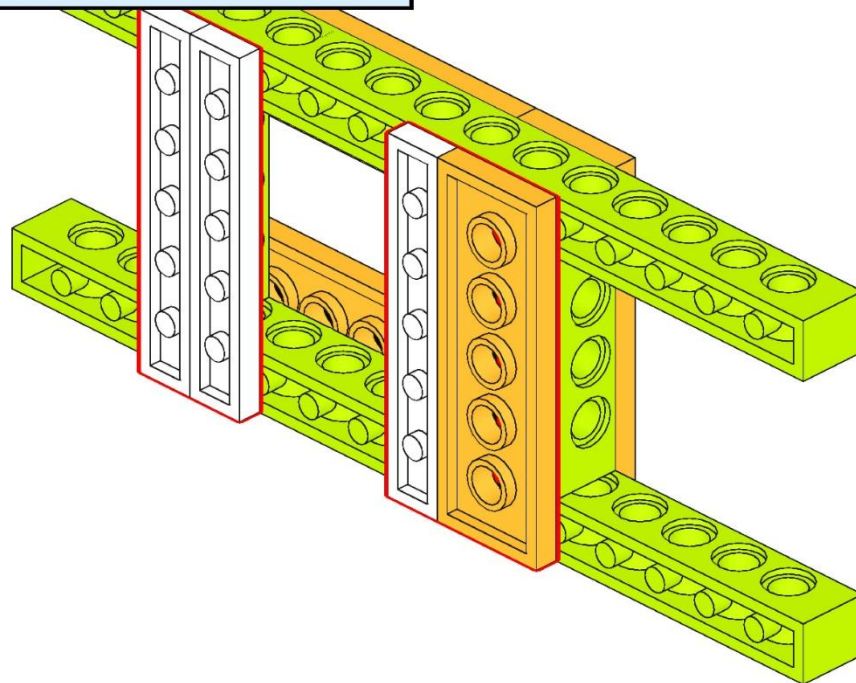
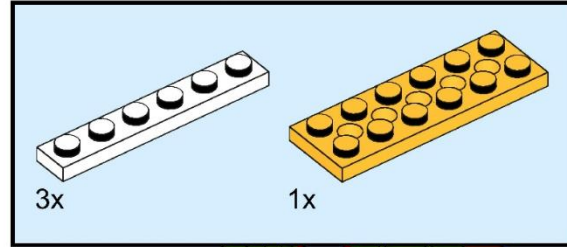

WEDO 2.0 «ЖУК»

4

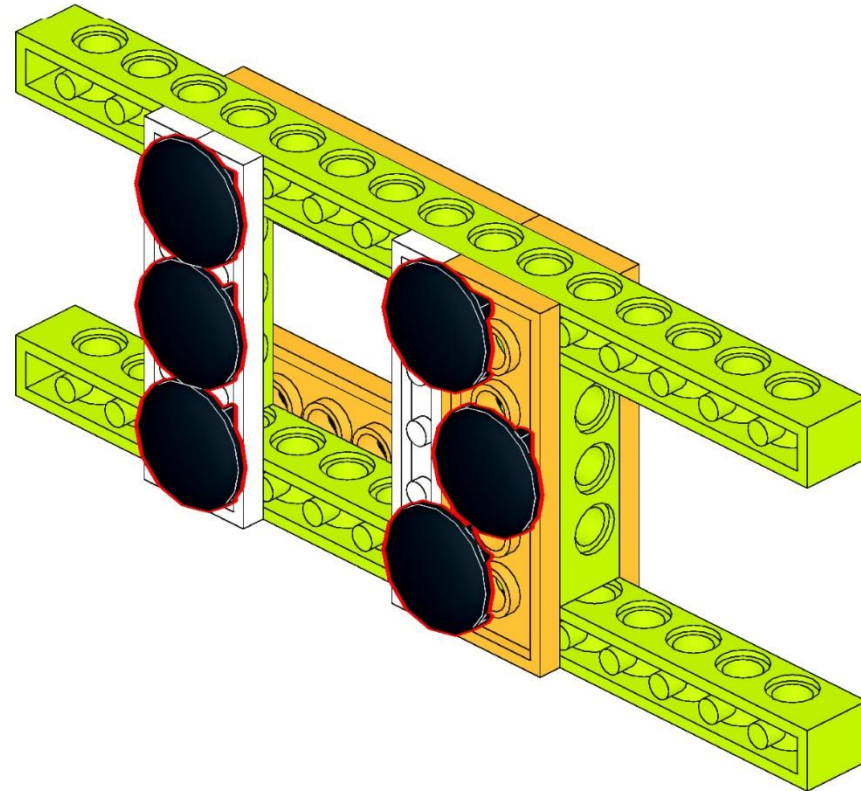
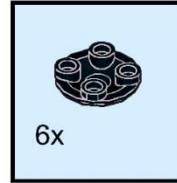

WEDO 2.0 «ЖУК»

5

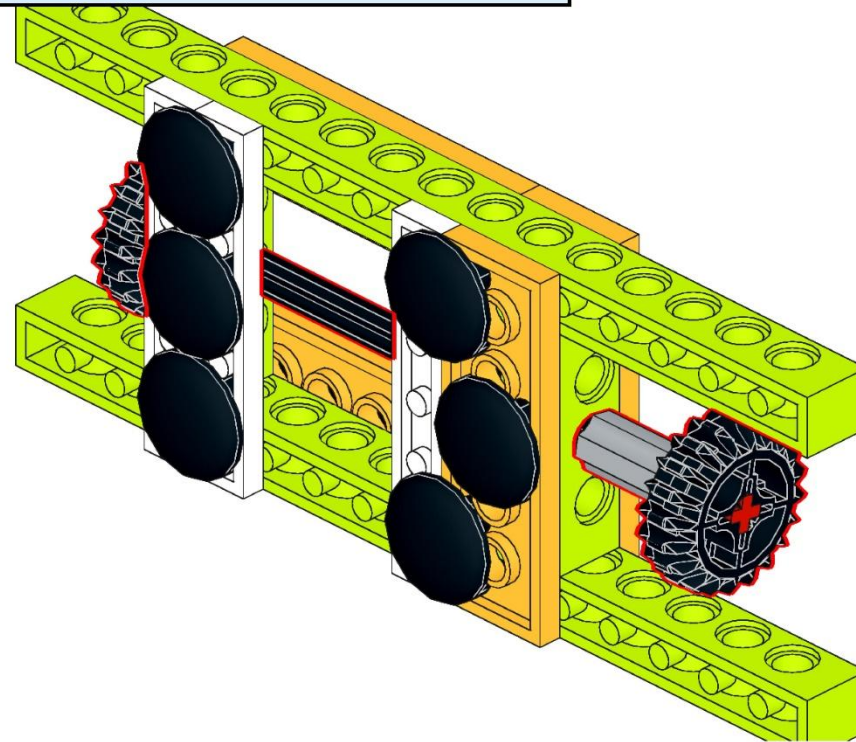
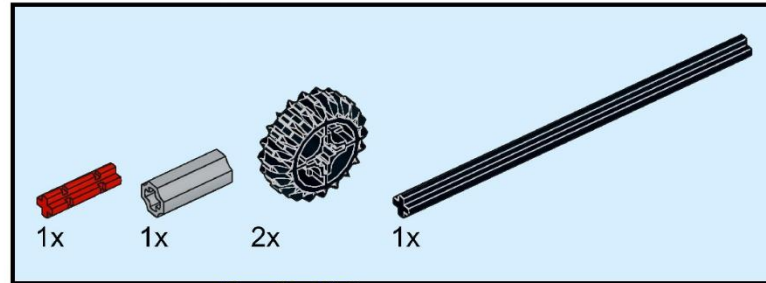

WEDO 2.0 «ЖУК»

6

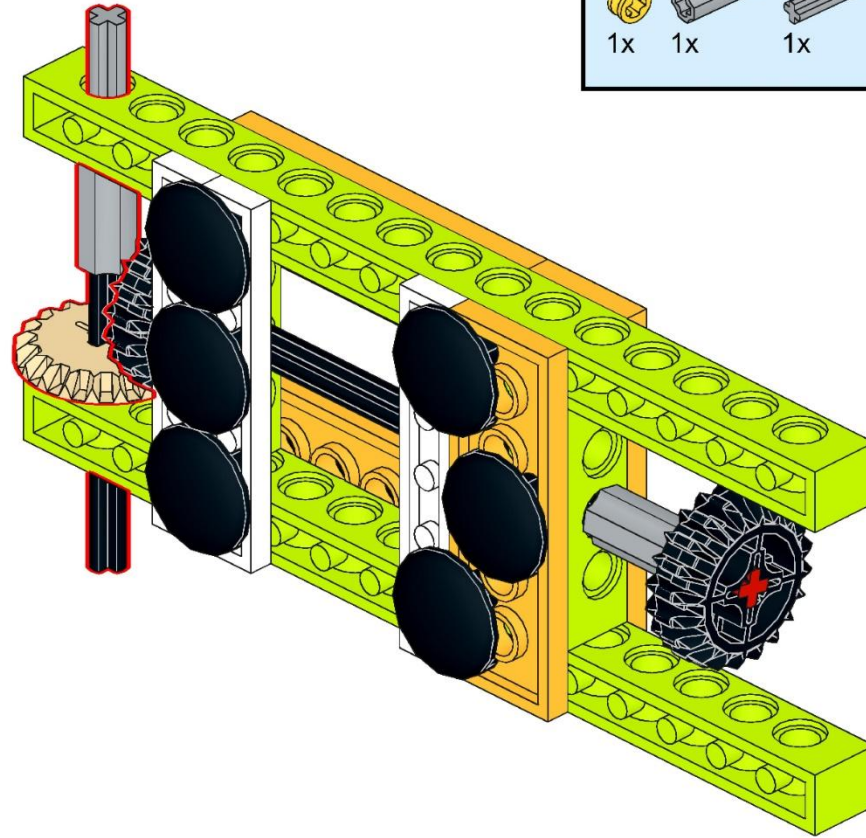
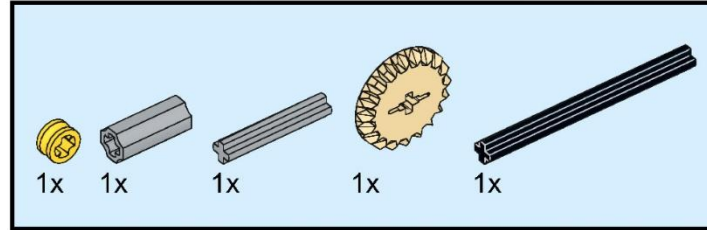

WEDO 2.0 «ЖУК»

7

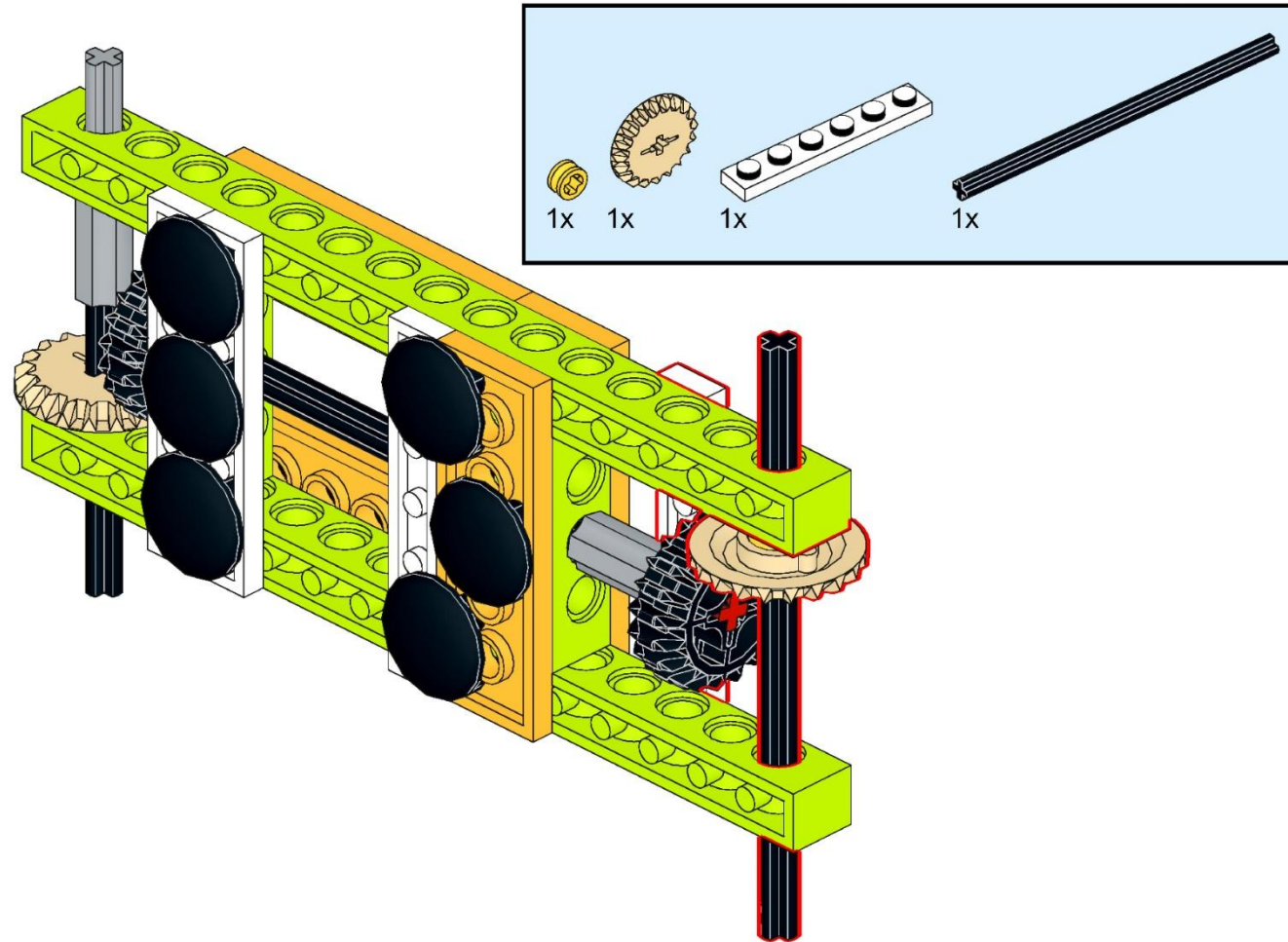

WEDO 2.0 «ЖУК»

8

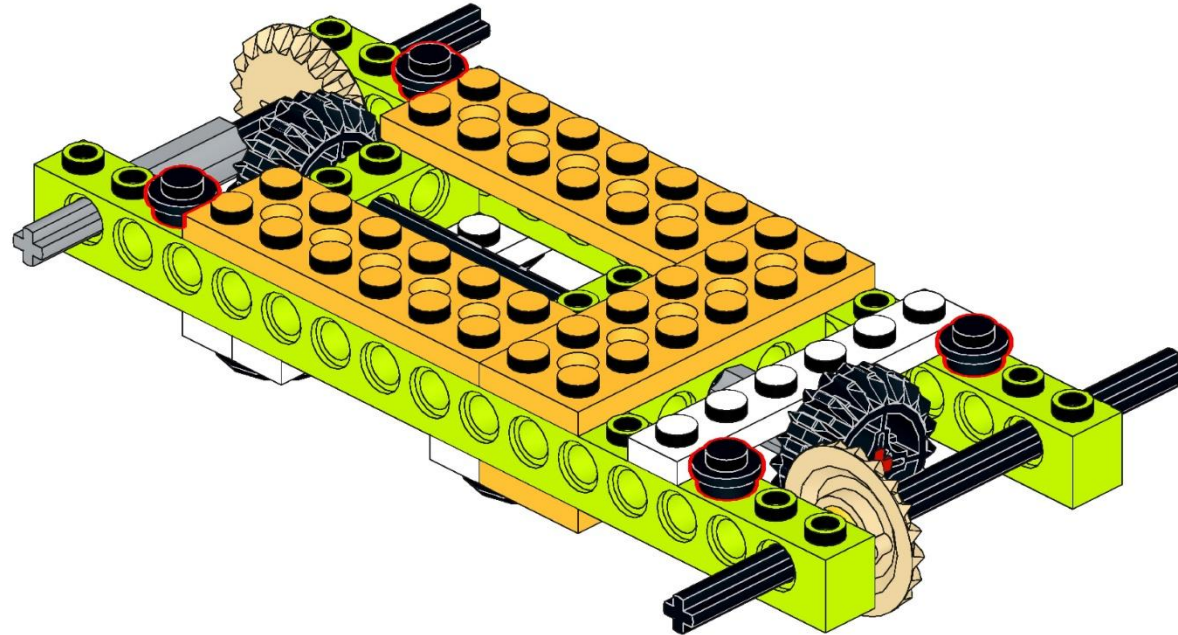

WEDO 2.0 «ЖУК»

9

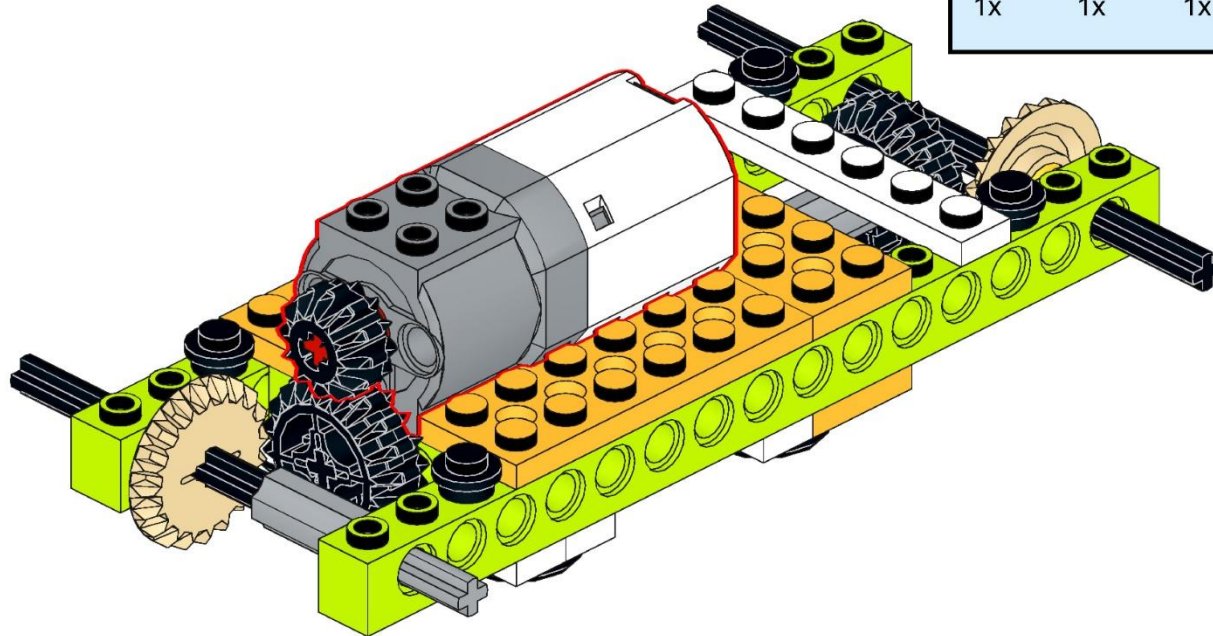
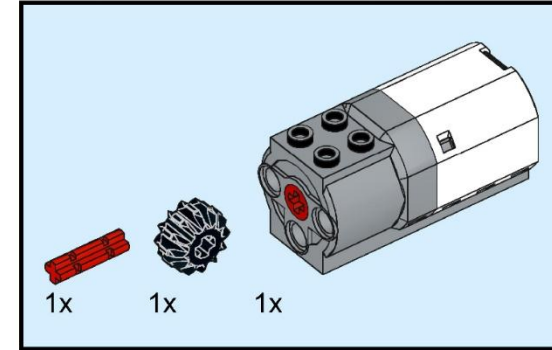

WEDO 2.0 «ЖУК»

10

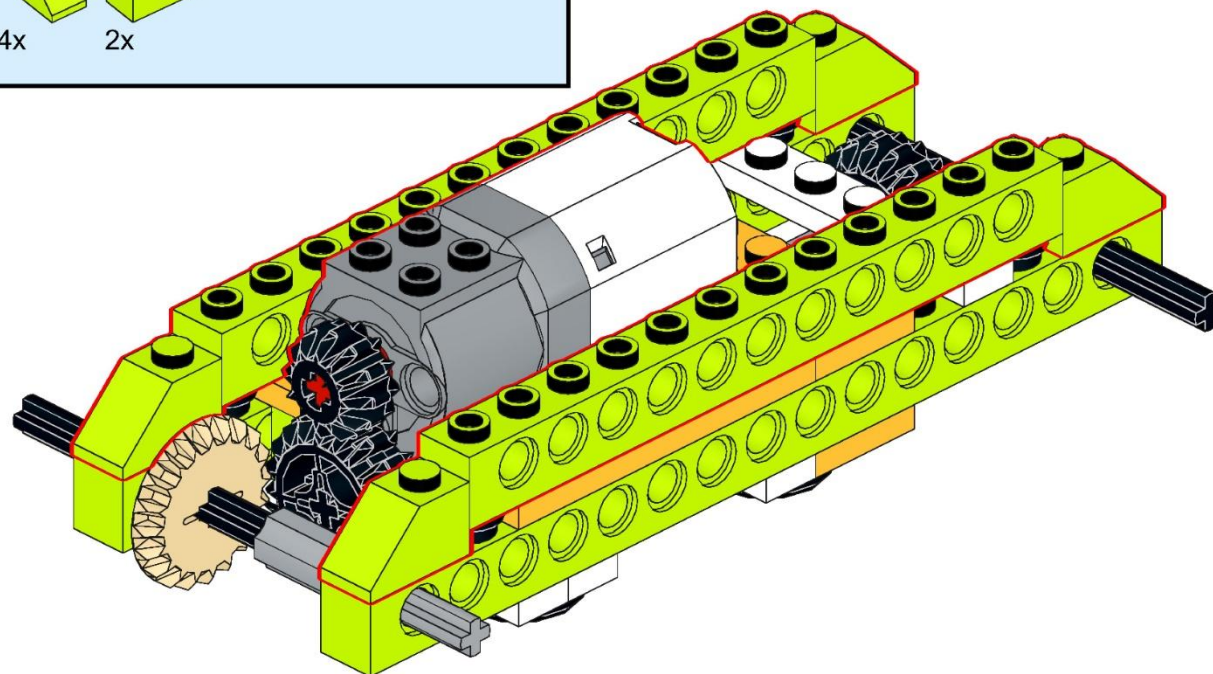
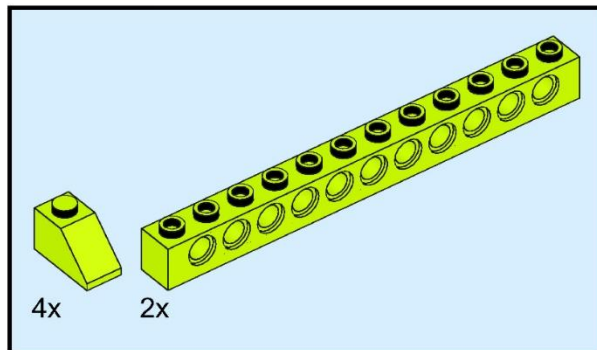

WEDO 2.0 «ЖУК»

11

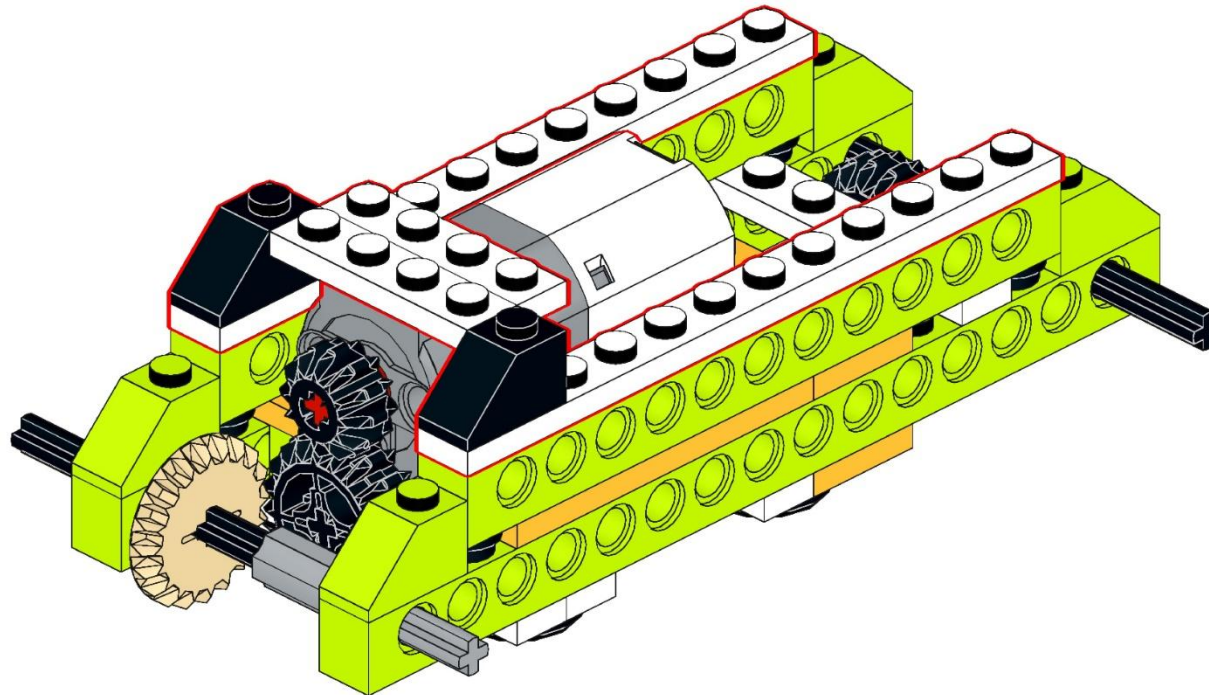
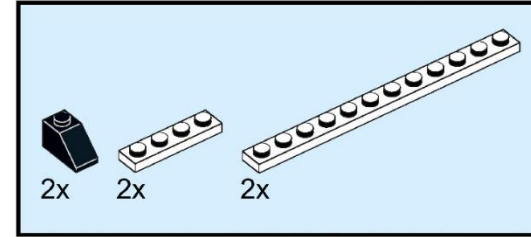

WEDO 2.0 «ЖУК»

12

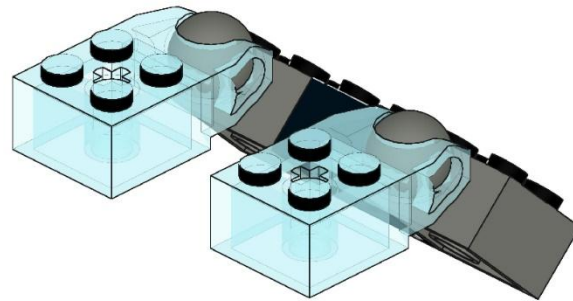
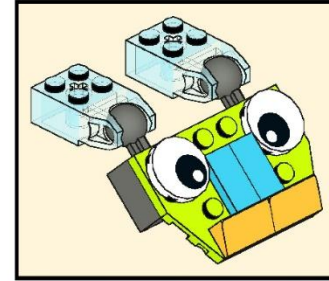
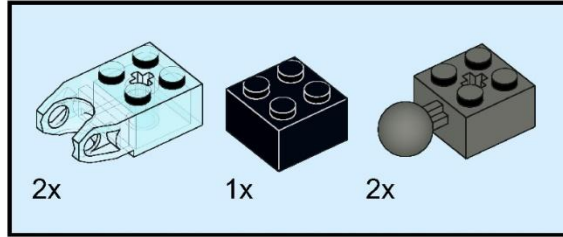

WEDO 2.0 «ЖУК»

13

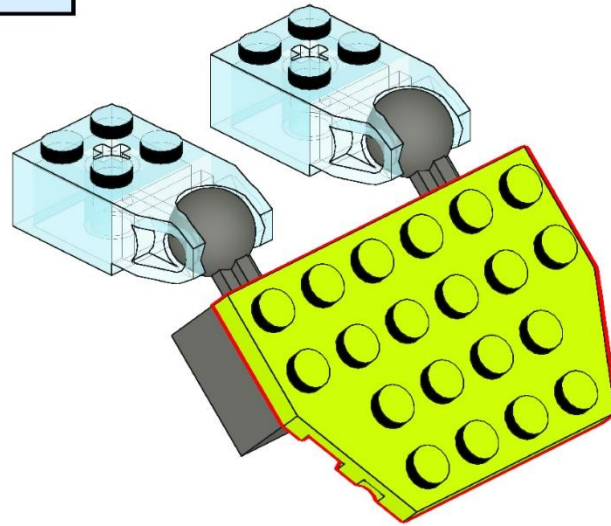
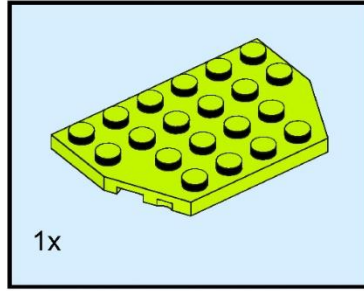

WEDO 2.0 «ЖУК»

14

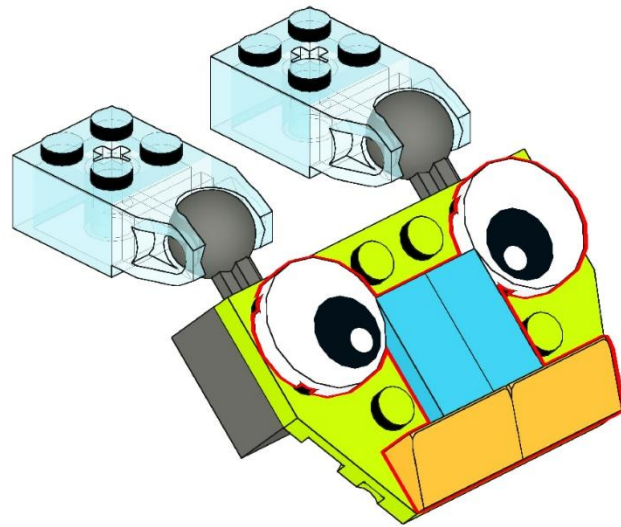
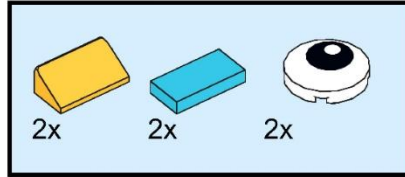

WEDO 2.0 «ЖУК»

15

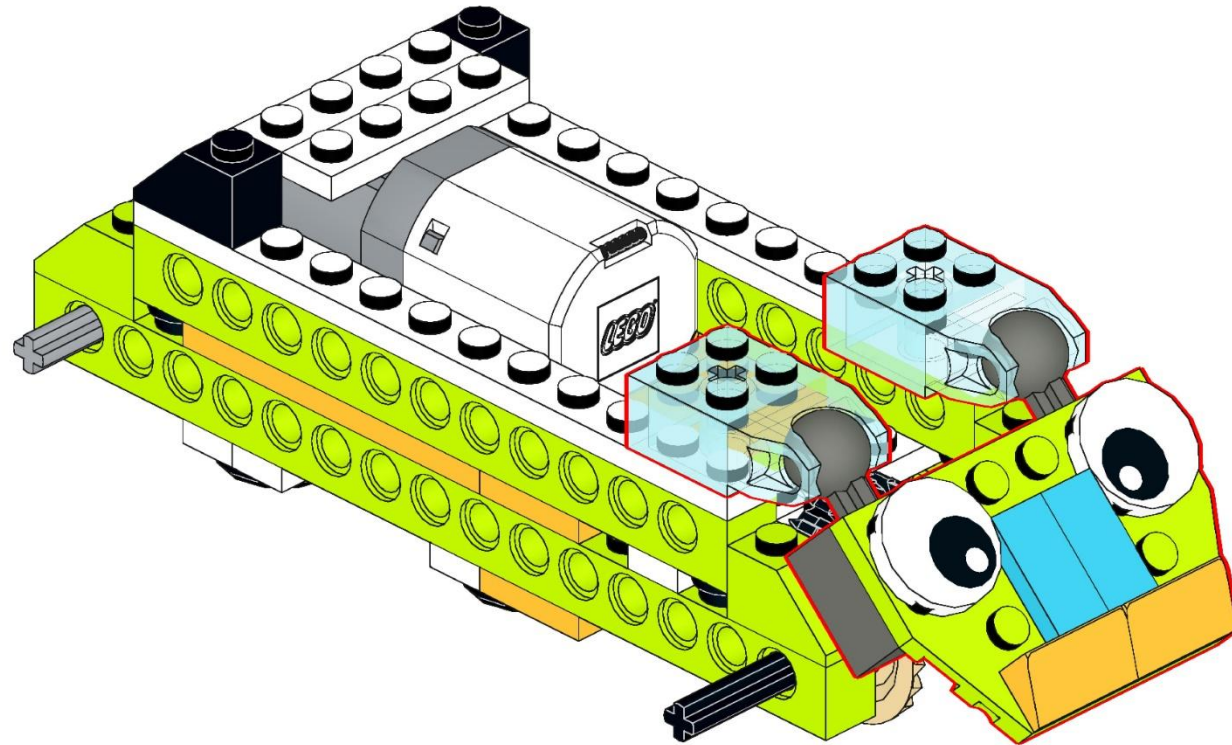

WEDO 2.0 «ЖУК»

16

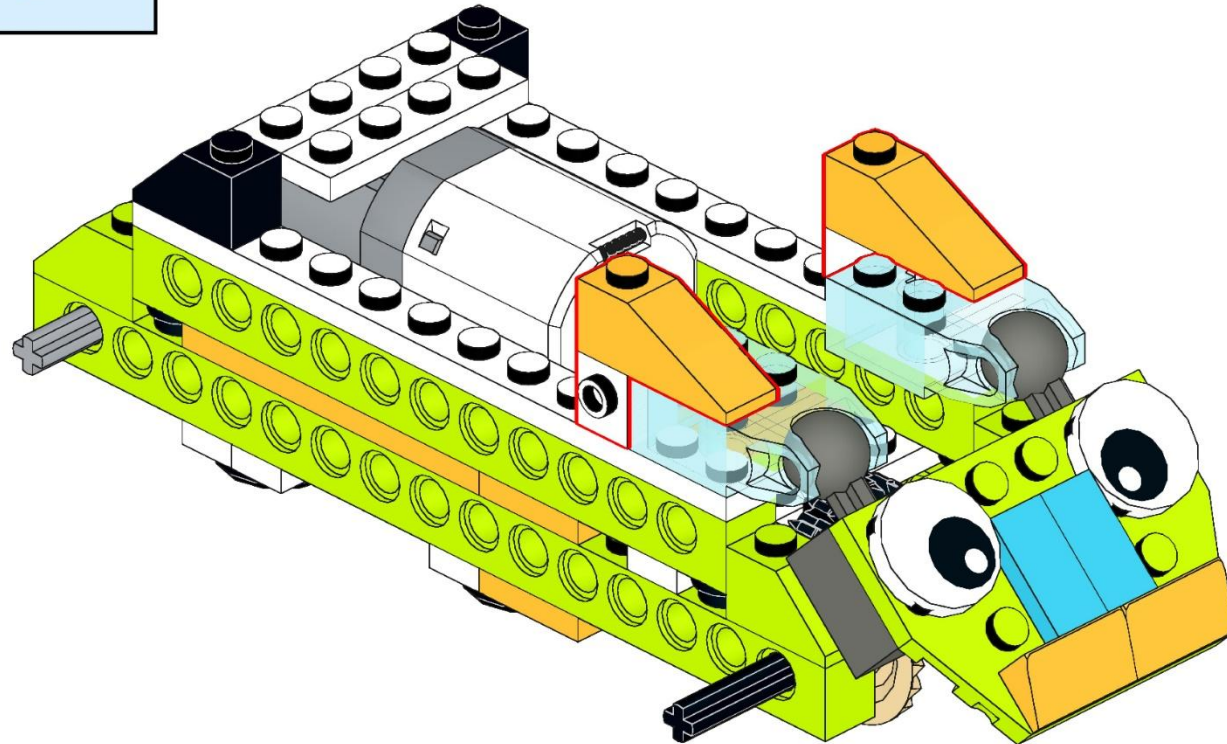
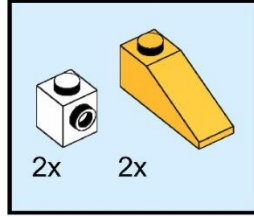

WEDO 2.0 «ЖУК»

17

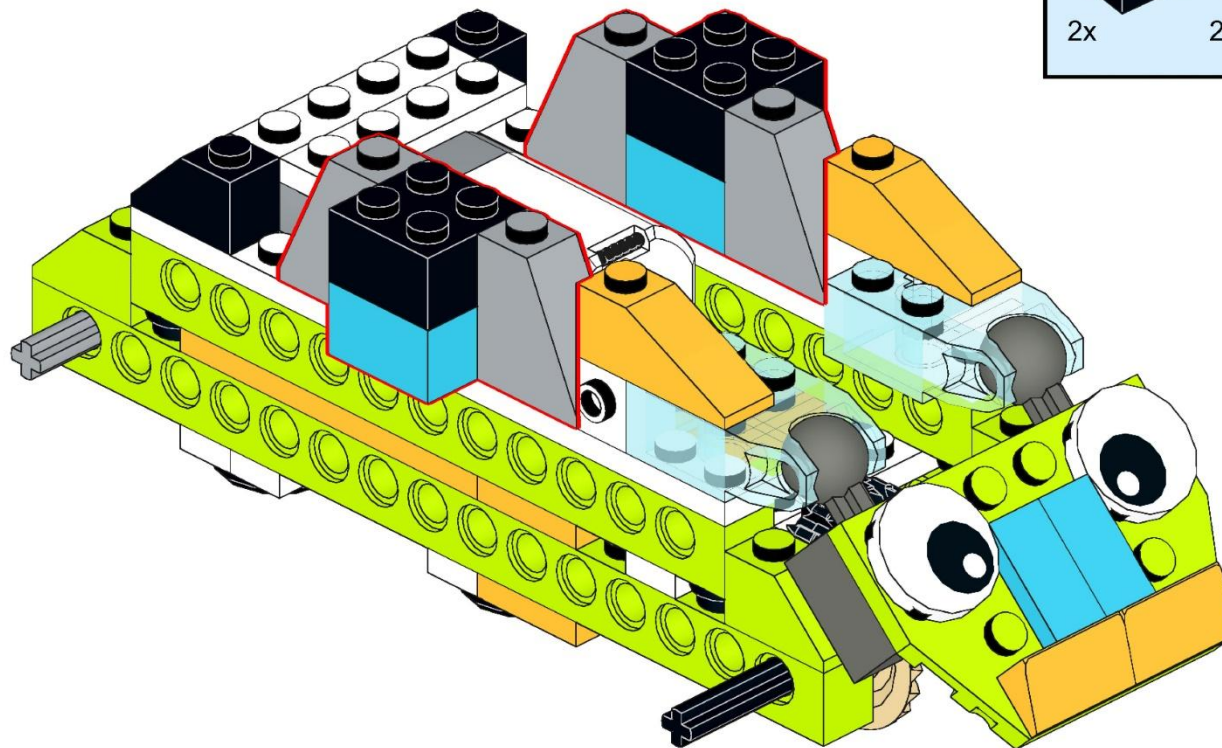
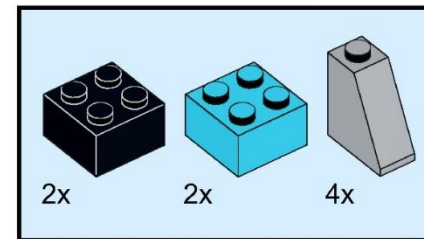

WEDO 2.0 «ЖУК»

18

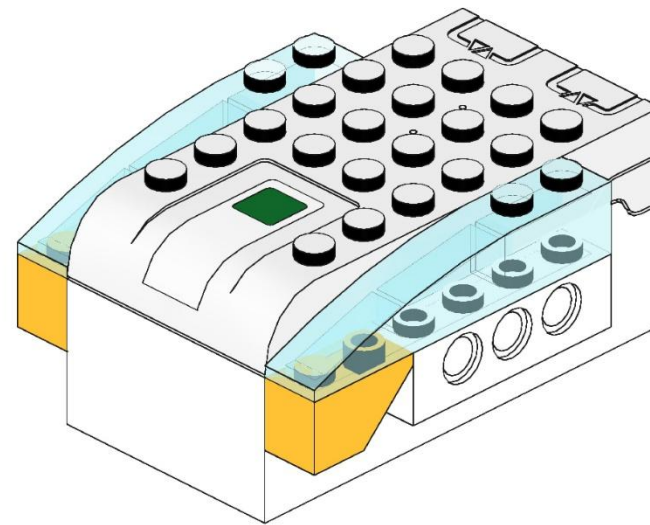
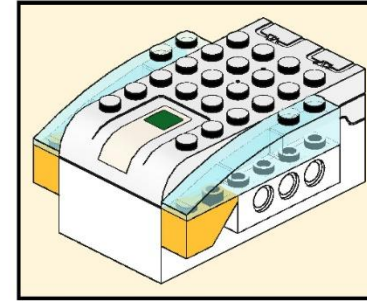
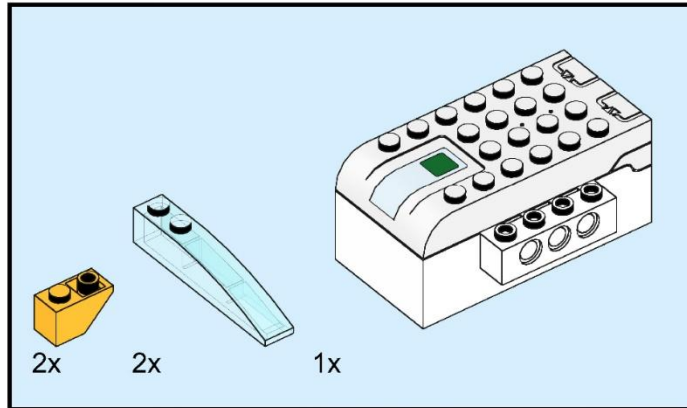

WEDO 2.0 «ЖУК»

19

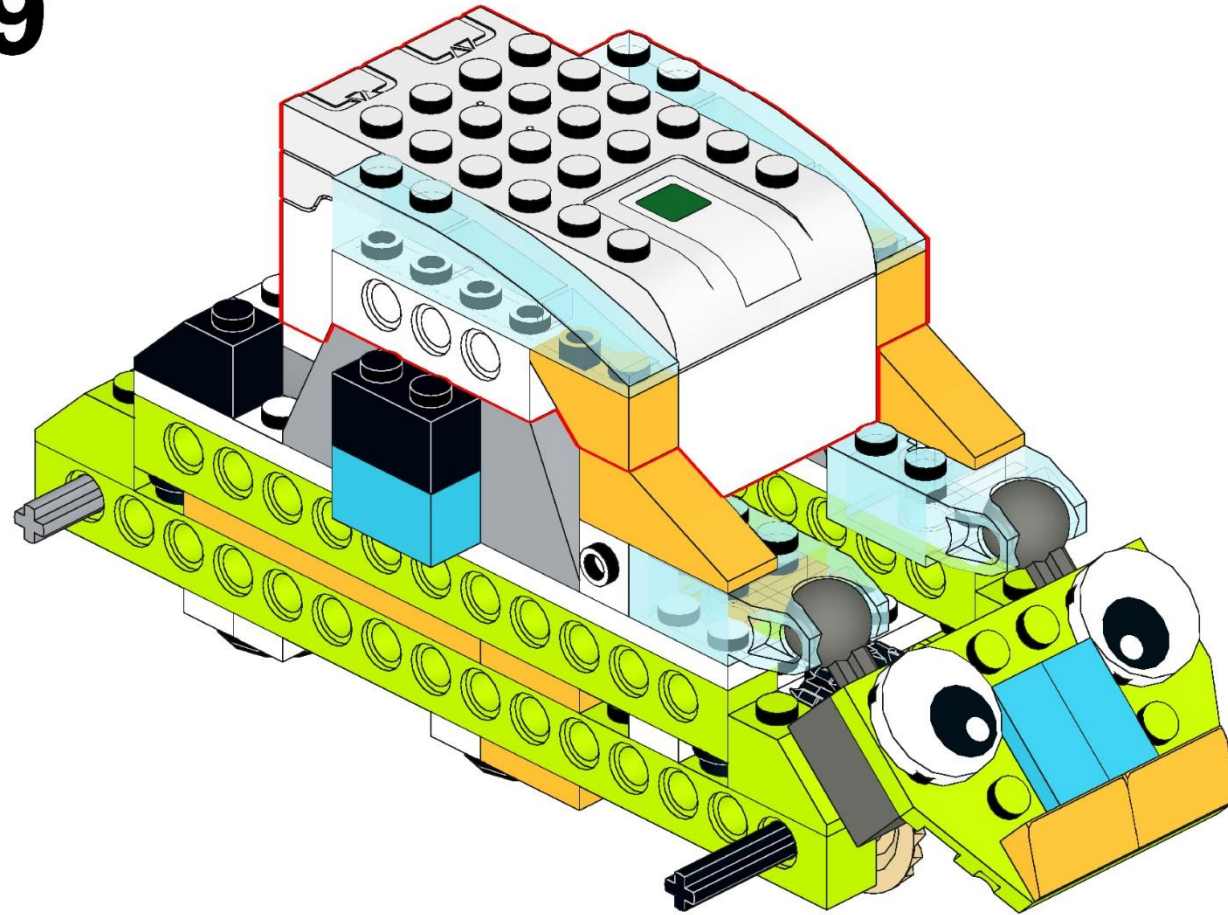

WEDO 2.0 «ЖУК»

20

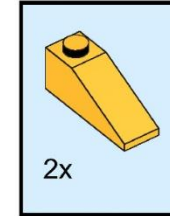
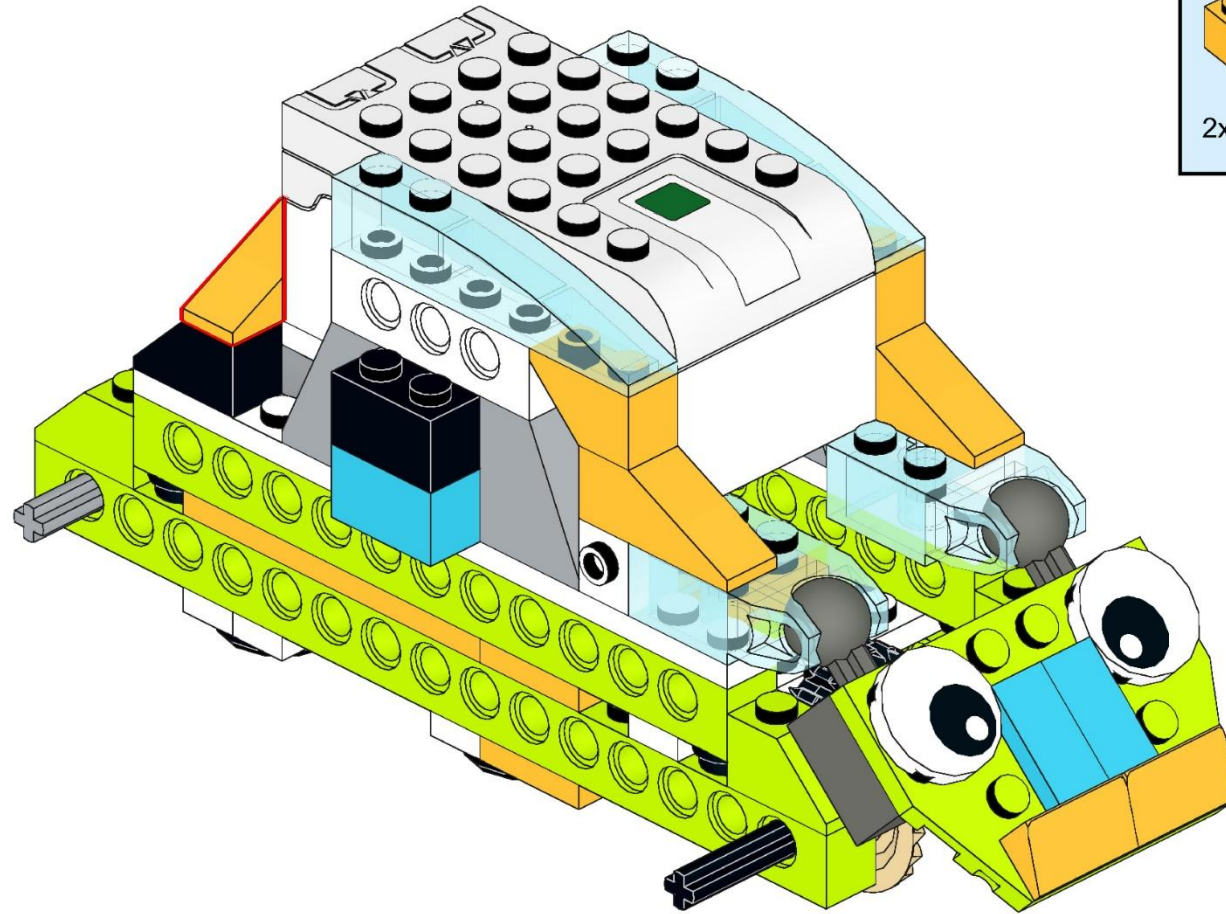

WEDO 2.0 «ЖУК»

21

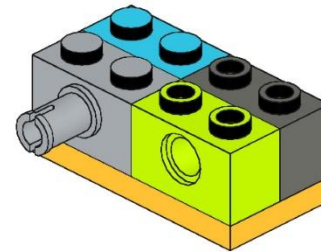
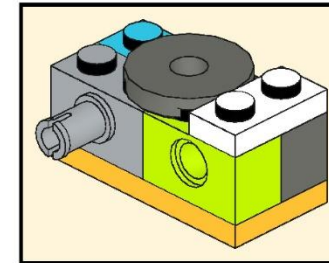
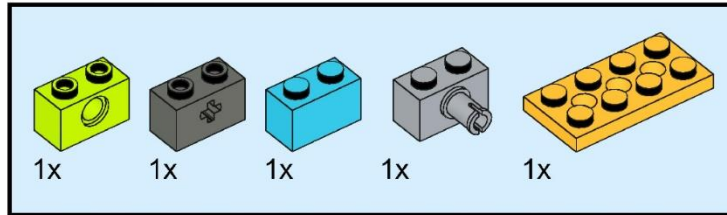

WEDO 2.0 «ЖУК»

22

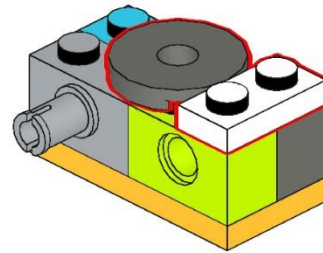
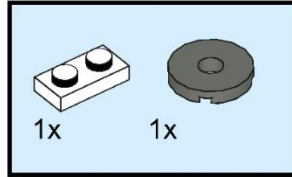

WEDO 2.0 «ЖУК»

23

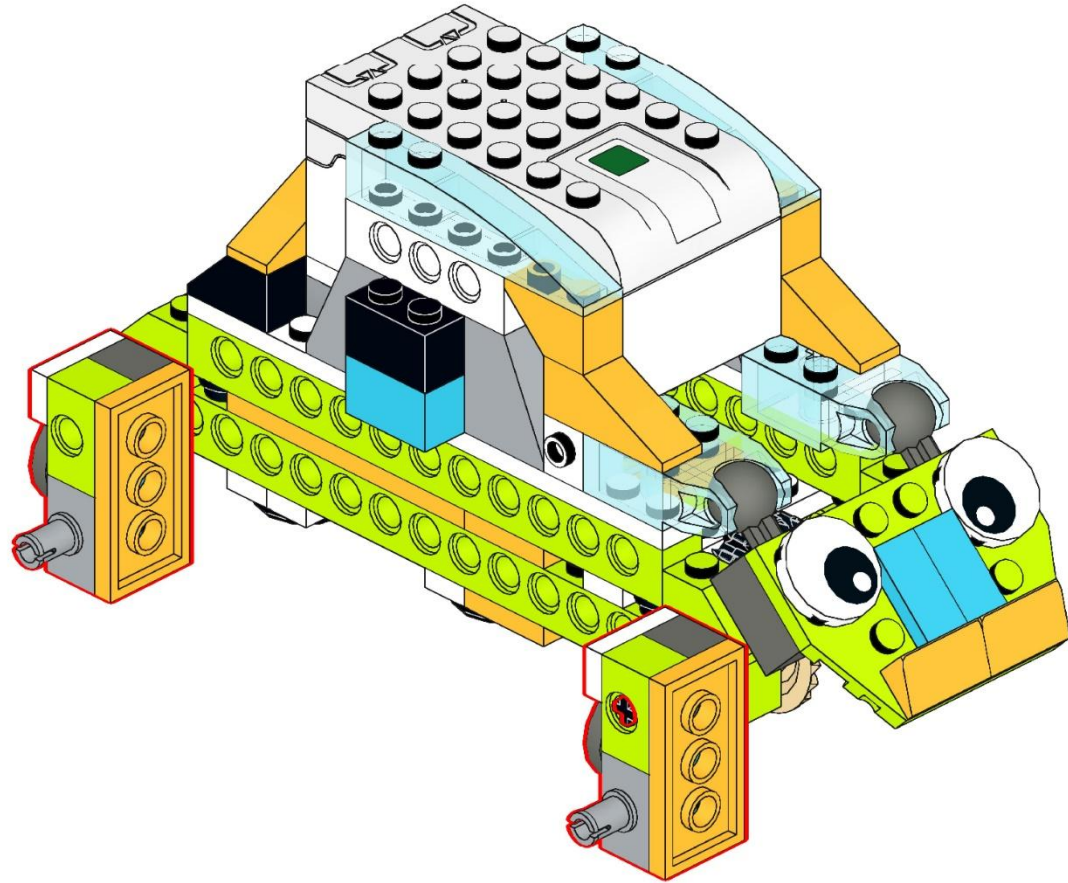

WEDO 2.0 «ЖУК»

24

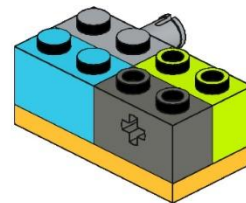
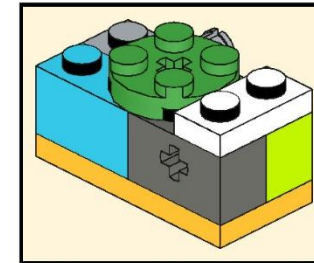
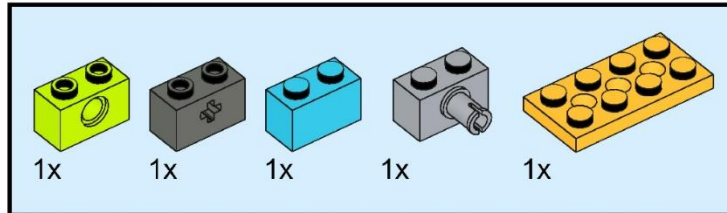

WEDO 2.0 «ЖУК»

25

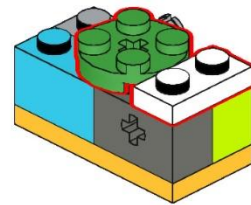
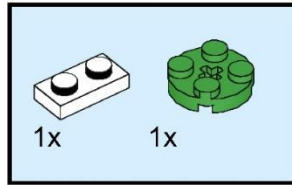

WEDO 2.0 «ЖУК»

26

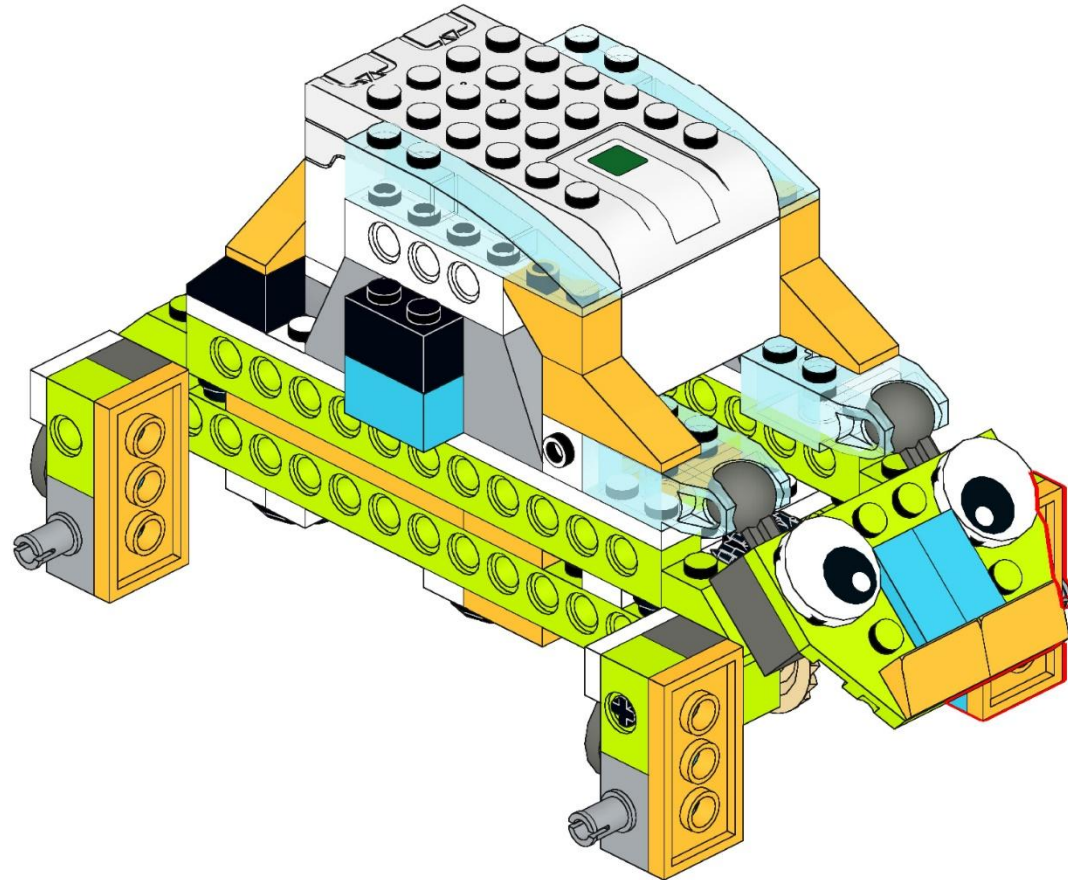

WEDO 2.0 «ЖУК»

27

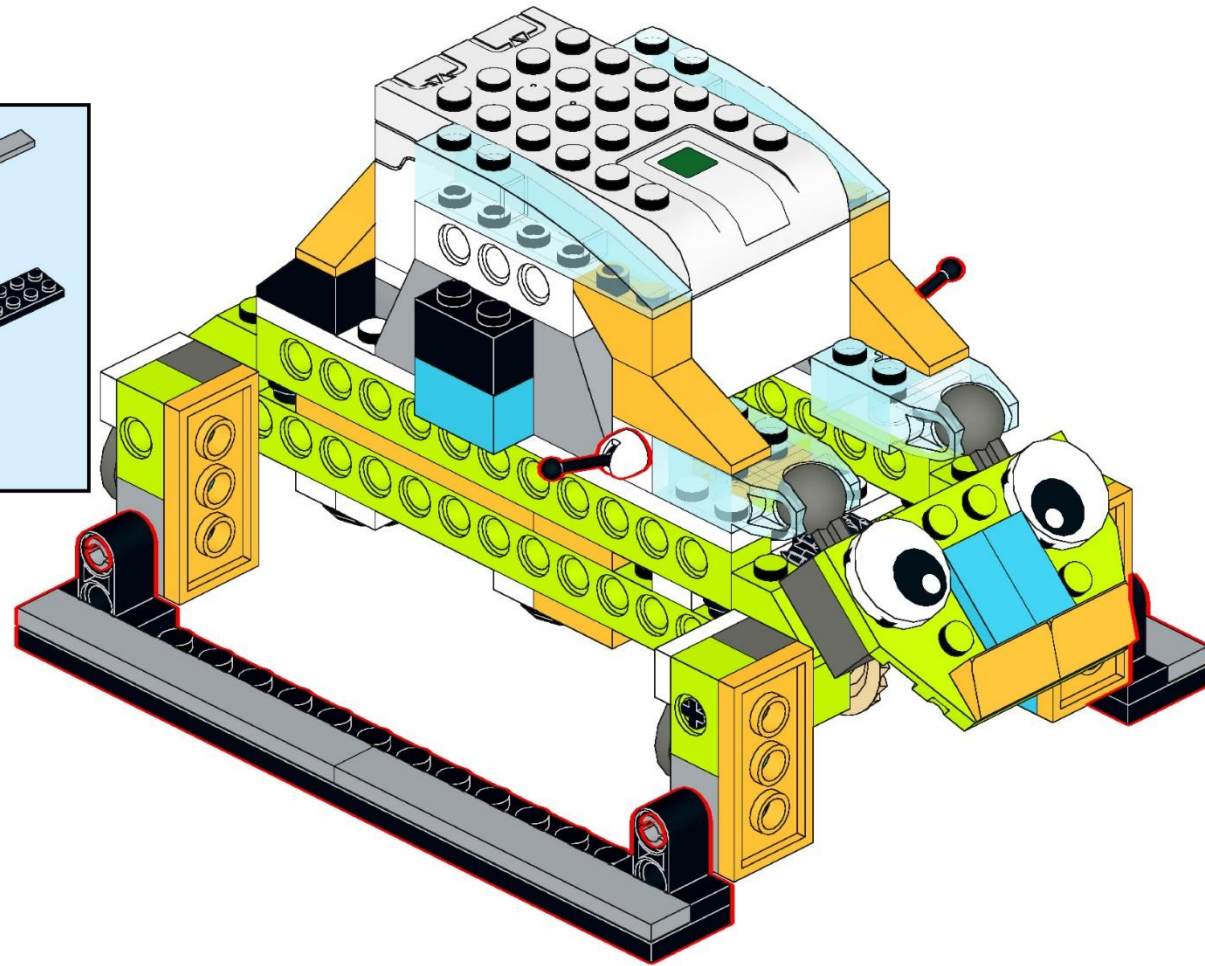
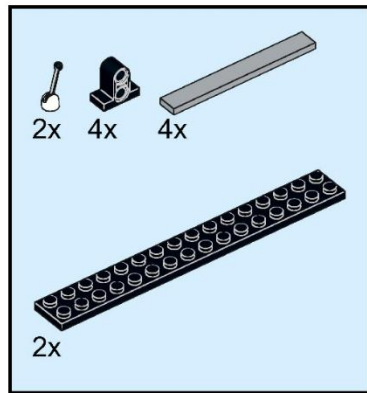

WEDO 2.0 «ЖУК»

УПРАВЛЯЮЩАЯ ПРОГРАММА:



WEDO 2.0 «ЖУК»

ЗАДАНИЯ:

- 1) Составьте управляющую программу по следующему алгоритму: 5 шагов вперед, 5 шагов назад, 10 шагов вперед и остановить.
- 2) Подсоедините датчик движения и запустите управляющую программу по созданному алгоритму.

Спасибо за
работу!