

МИНИСТЕРСТВО НАУКИ И ВЫСШЕГО ОБРАЗОВАНИЯ РОССИЙСКОЙ
ФЕДЕРАЦИИ
ФГАОУ ВО «КРЫМСКИЙ ФЕДЕРАЛЬНЫЙ УНИВЕРСИТЕТ ИМЕНИ В.И.
ВЕРНАДСКОГО»
МЕДИЦИНСКАЯ АКАДЕМИЯ ИМЕНИ С.И. ГЕОРГИЕВСКОГО
(структурное подразделение)

HEMOPOIESIS. IMMUNOLOGY

Автор доцент кафедры гистологии
и эмбриологии Лугин И.А.

Committed
Precursor
Cells

Lineage
Committed
Cells



HEMOPOIESIS.

- **The formation of blood cells in the prenatal life is named Hemopoiesis (Gr. *haima*, *blood + poiesis*, *a making*). Mature blood cells have a relatively short life span and must be continuously replaced with new cells from precursors developing *In the early embryo these blood cells arise in the yolk sac mesoderm. In the second trimester, hemopoiesis (also called hematopoiesis) occurs primarily in the developing liver, with the spleen playing a minor role***
- ***Skeletal elements begin to ossify and bone marrow develops in their medullary cavities, so in the third-trimester marrow of specific bones becomes the major hemopoietic organ.***

HEMATOPOIESIS IN EMBRYONIC AND FETAL LIFE

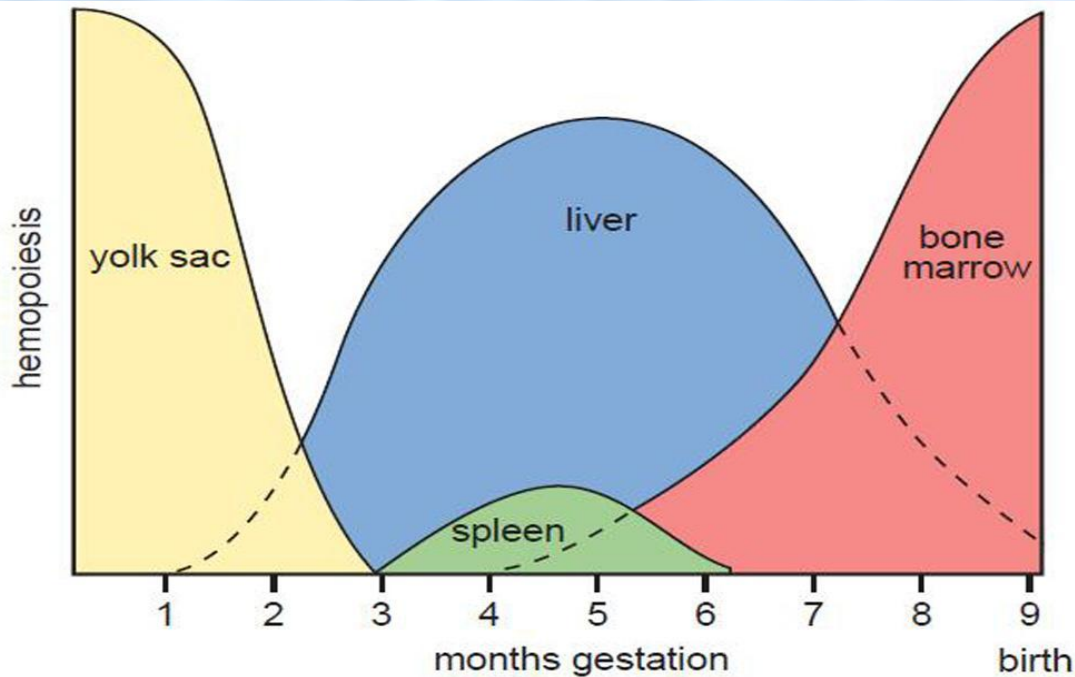

FIGURE 10.18 • Dynamics of hemopoiesis in embryonic and fetal life. During embryonic and fetal life, erythrocytes are formed in several organs. Essentially, three major organs involved in hemopoiesis can be sequentially identified: The yolk sac in the early developmental stages of the embryo; the liver during the second trimester of pregnancy; and the bone marrow during the third trimester. The spleen participates to a very limited degree during the second trimester of pregnancy. At birth, most hemopoiesis occurs in the red bone marrow, as it does in the adult.

Mesoblastic
Hepatic
Splenic
Thymic
Medullary

Theories of hematopoiesis



The *monophyletic theory* suggests that a *pluripotent stem cell (CFU-S)* can form all mature blood cell types.

The several *polyphyletic theories* suggest that each mature blood cell type is derived from a distinct stem cell.

Hemopoietic Stem Cells

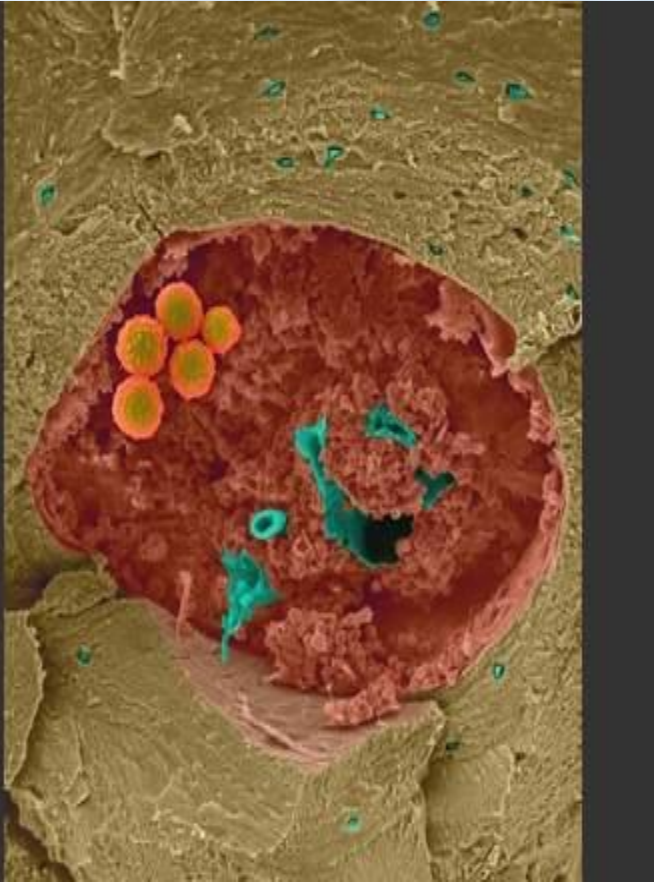

- All blood cells arise from a single type of pluripotent hemopoietic stem cell in the bone marrow that can give rise to all the blood cell types. These pluripotent stem cells are rare, proliferate slowly, and give rise to two major lineages of progenitor cells with restricted potentials (committed to produce specific blood cells): one for lymphoid cells (lymphocytes) and another for myeloid cells (Gr. *myelos, marrow*), which develop in bone marrow. Myeloid cells include granulocytes, monocytes, erythrocytes, and megakaryocytes.
- The immune system, the lymphoid progenitor cells migrate from the bone marrow to the thymus or the lymph nodes, spleen, and other lymphoid structures, where they proliferate and differentiate.

Progenitor & Precursor Cells

- The progenitor cells for blood cells are often called **colony-forming units (CFUs)**, because they give rise to colonies of only one cell type when cultured in vitro or injected into a spleen.
- **There are four major types of progenitor cells/CFUs:**
 - Erythroid lineage of erythrocytes
 - Thrombocytic lineage of megakaryocytes for platelet formation
 - Granulocyte-monocyte lineage of all three granulocytes and monocytes
 - Lymphoid lineage of B lymphocytes, T lymphocytes, and natural killer cells

Figure 6-16. Hematopoietic branching lineage tree

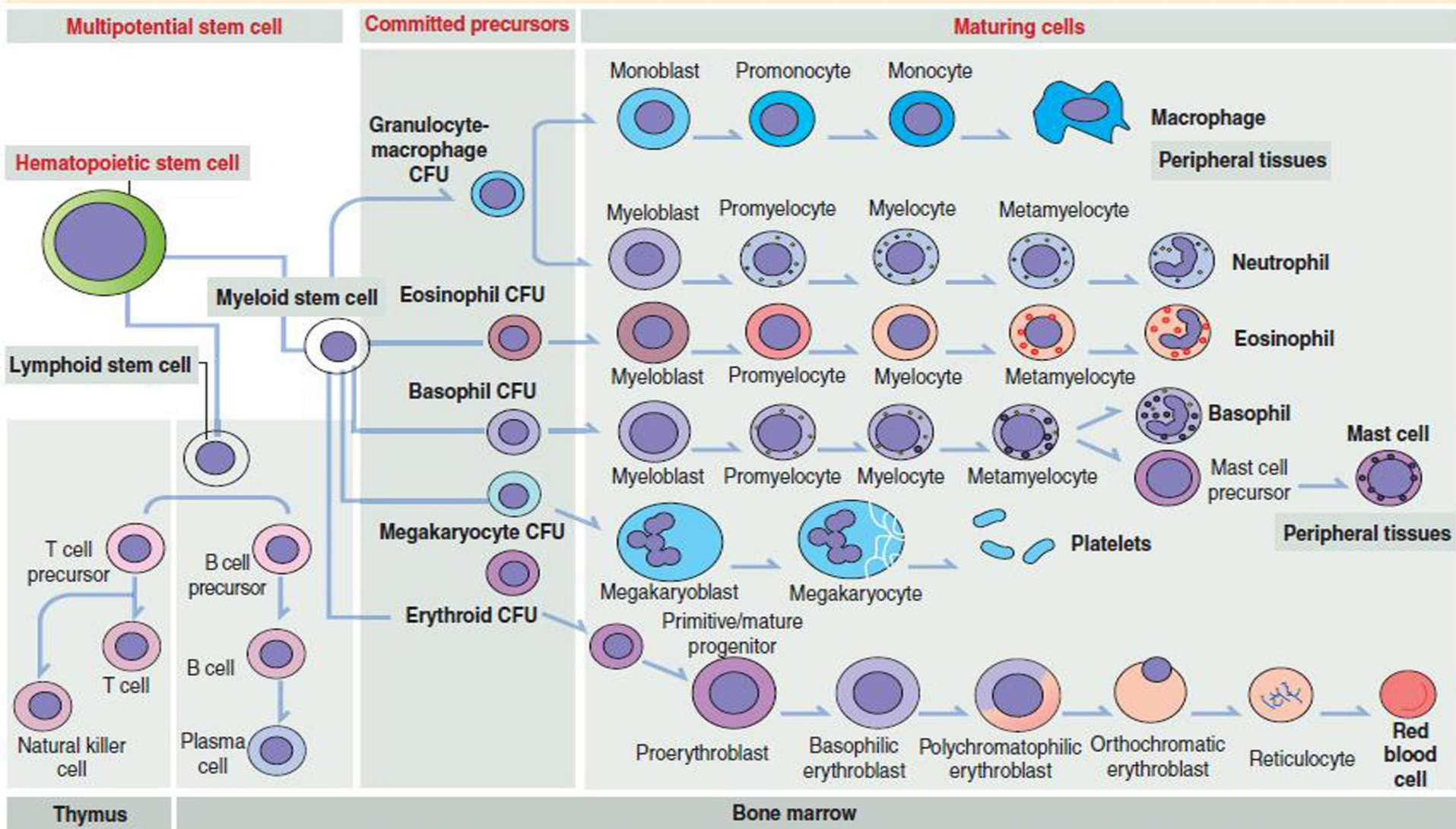

The bone marrow consists of: (1) **Hematopoietic stem cells (HSCs)**, multipotential cells capable of self-renewal. (2) **Committed precursor cells (myeloid stem cell and lymphoid stem cell)**. (3) **Maturing cells**. Maturing cells develop from cells called **colony-forming units (CFUs)**. The **myeloid stem cell** gives rise to CFUs responsible for the regeneration of red blood cells (**erythroid CFUs**), platelets (**megakaryocyte CFUs**),

basophils and mast cells (**basophil CFUs**), and eosinophils (**eosinophil CFUs**). Monocytes and neutrophils derive from a common committed progenitor cell (**granulocyte-macrophage CFU**). The **lymphoid stem cell** generates the **B cell progeny** in the **bone marrow** and **T cell progenies** in the **thymus**. They are discussed in detail in Chapter 10, Immune-Lymphatic System.

Hematopoietic stem cell niche

- This event requires a special environment, termed the **hematopoietic stem cell niche**, which provides the protection and signals necessary to carry out the differentiation of cells from HSC progenitors. This niche relocates from the yolk sac, which provides the protection and signals necessary to carry out the differentiation of cells from HSC progenitors. This niche relocates from the yolk sac to eventually rest in the bone marrow of mammals. Many pathological states can arise from disturbances in this niche environment, highlighting its importance in maintaining hematopoiesis

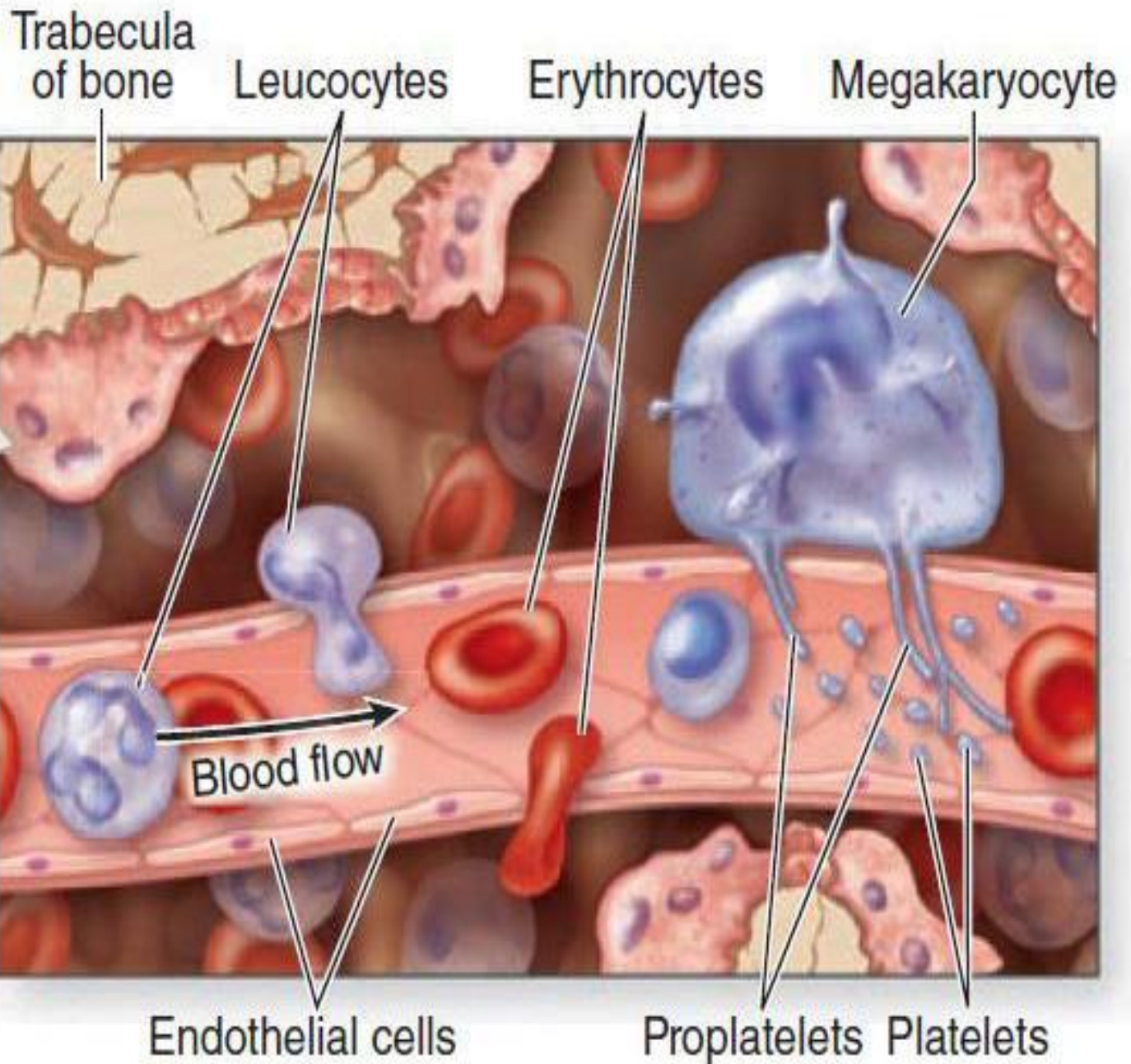

PHSC Niche in RBM

Red bone marrow

- Red bone marrow contains a reticular connective tissue **stroma** (*Gr. stroma, bed*), **hemopoietic cords or islands of cells, and sinusoidal capillaries**.
- **The stroma is a meshwork of specialized fibroblastic cells called stromal cells (also called reticular or adventitial cells) and a delicate web of reticular fibers supporting the hemopoietic cells and macrophages.**
- **The matrix of bone marrow also contains collagen type I, proteoglycans, fibronectin, and laminin, the latter glycoproteins interacting with integrins to bind cells to the matrix. Red marrow is also a site where older, defective erythrocytes undergo phagocytosis by macrophages, which then reprocess heme-bound iron for delivery to the differentiating erythrocytes.**

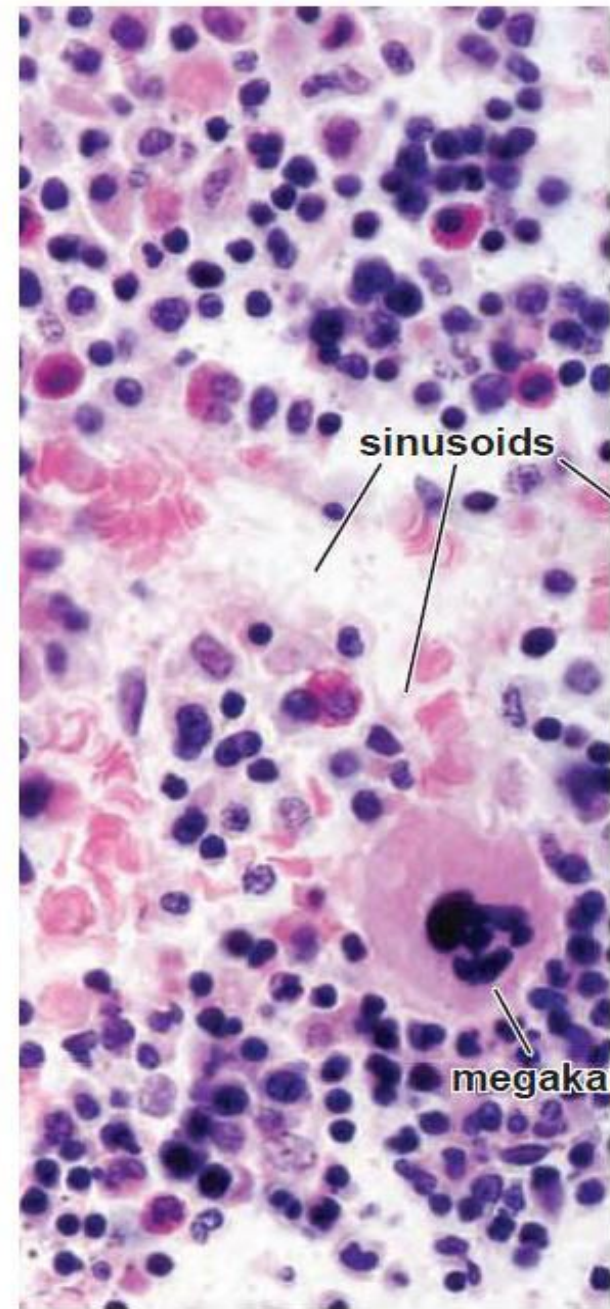
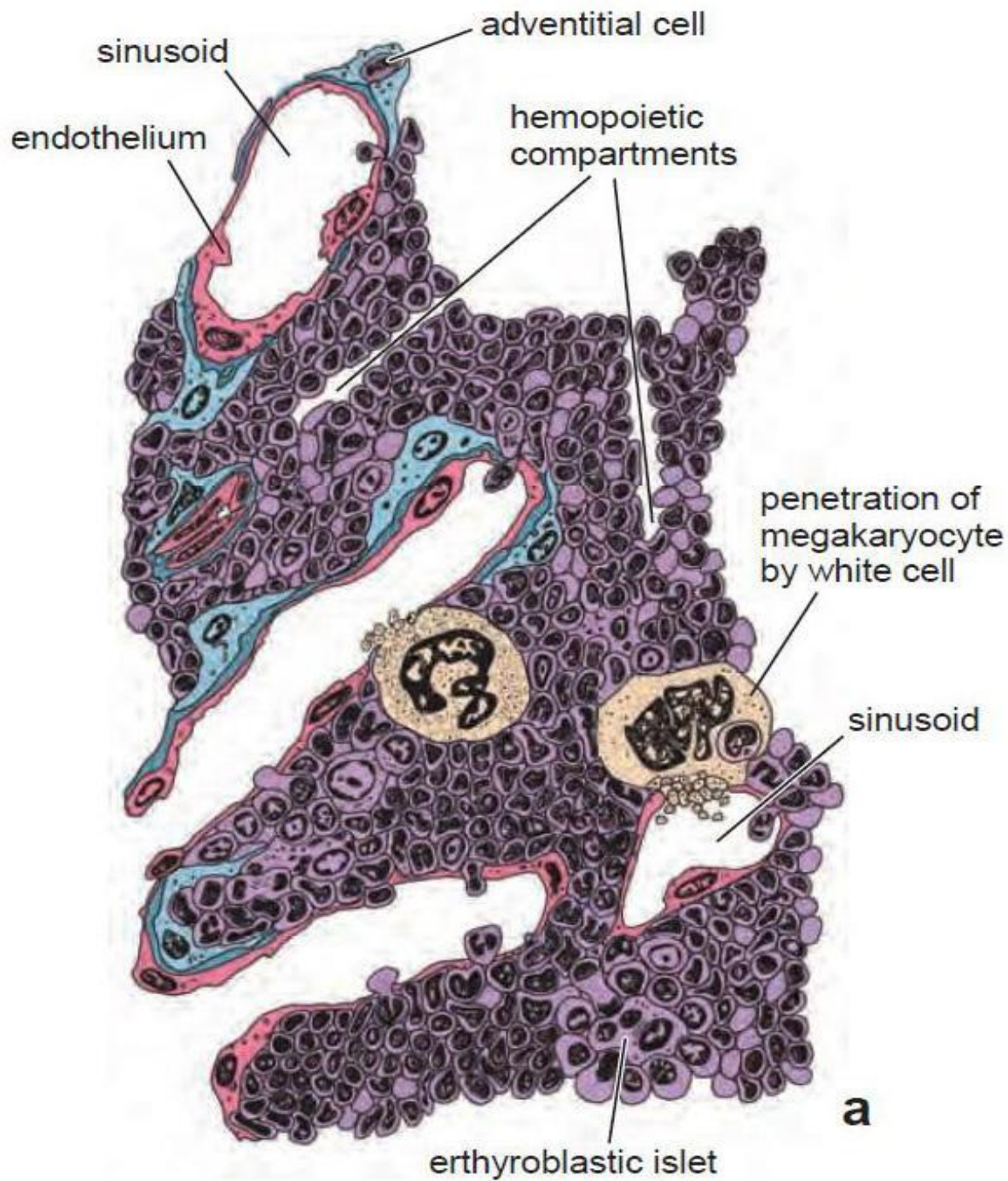

Erythropoiesis

- Erythropoiesis. In healthy adults, erythropoiesis (*red blood cell formation*) occurs exclusively in bone marrow. Erythrocytes derive from *CFU-Es*, which in turn derive from *CFU-Ss*. The differentiation of erythrocytes from stem cells is commonly described by naming cell types at specific stages in the process according to their histologic characteristics. Cellular changes that occur during erythroid differentiation include (1) decrease in cell size, (2) condensation of nuclear chromatin, (3) decrease in nuclear diameter, (4) accumulation of hemoglobin in the cytoplasm (increased acidophilia), (5) decline in the number of ribosomes in the cytoplasm (decreased basophilia) and (6) ejection of the nucleus.

Erythropoiesis

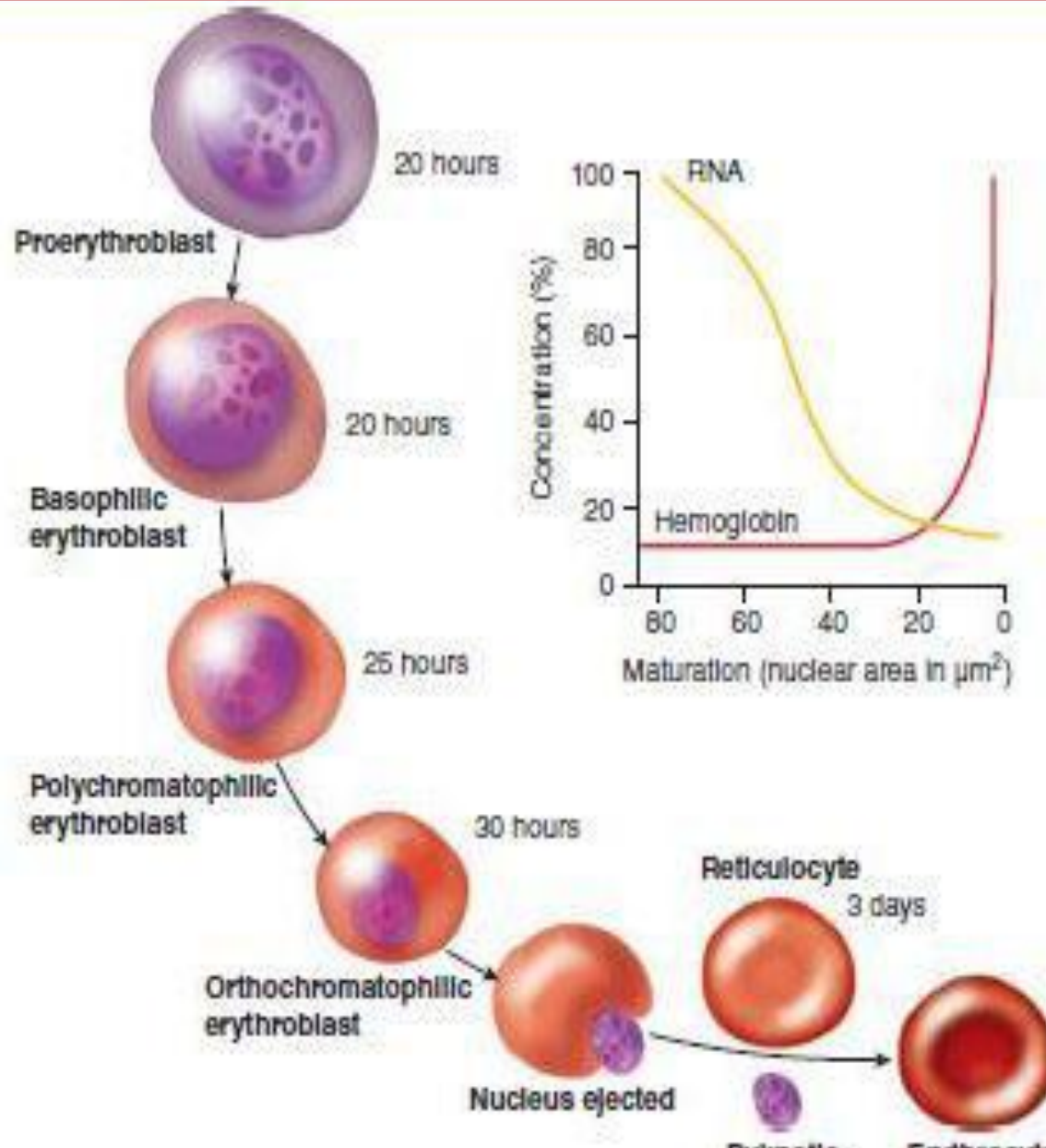

Structure of RED BONE MARROW

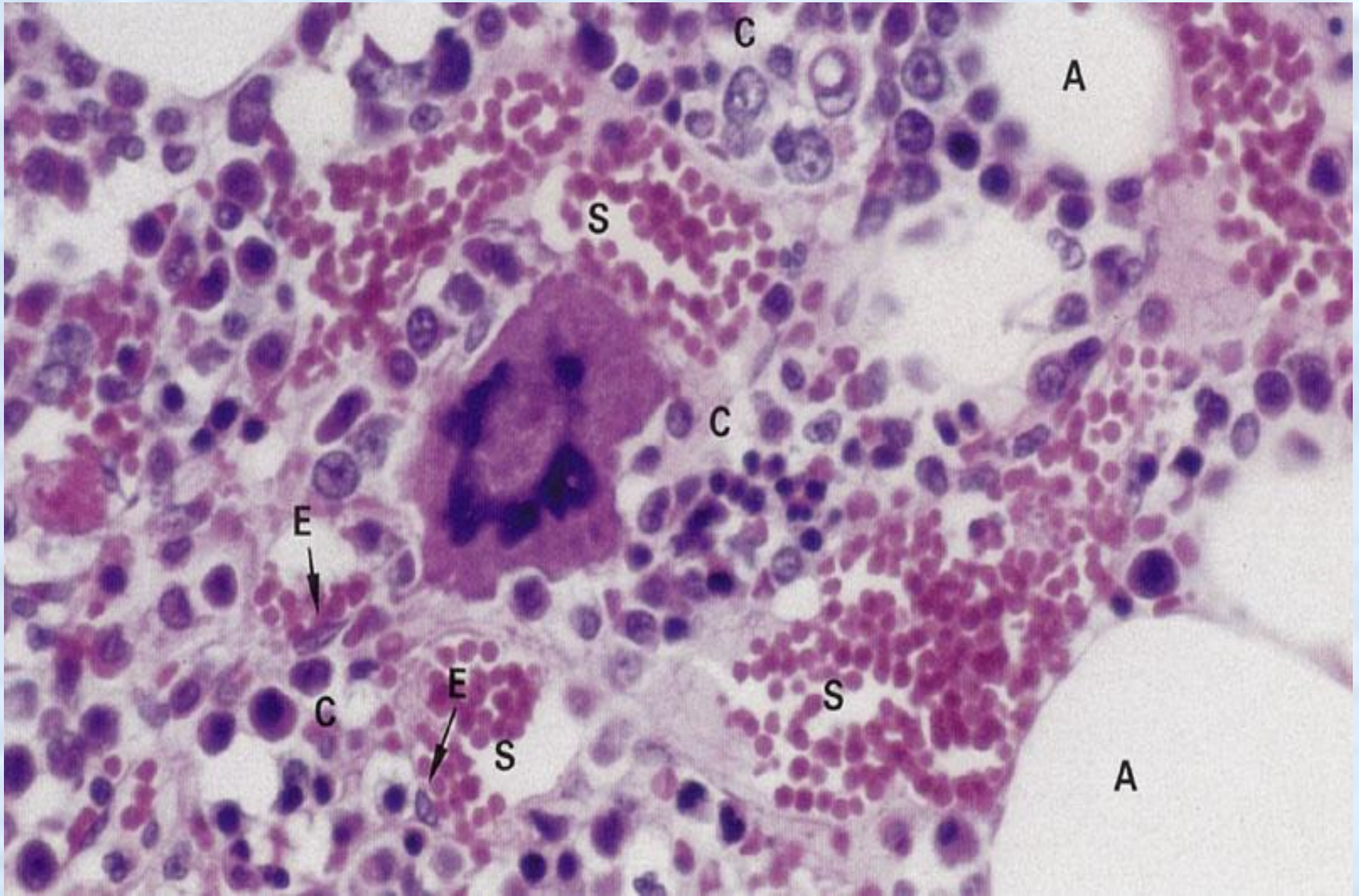

Erythrocyte maturation

- is commonly divided into *6 stages*. Cells at these stages (class of cells) are identified by examining their overall diameter, the size and chromatin pattern of their nuclei, and the staining properties of their cytoplasm. Cells in transition between these stages are commonly found in bone marrow smears. Cell division occurs throughout the early stages, but once cells reach the normoblast stage they generally lose their ability to divide. Starts with the least mature cells; the sixth stage is the mature erythrocyte (previous pages).
f. Proerythroblasts are large (14—19 μm in diameter) and contain a large, centrally located, pale-staining nucleus with one or 2 large nucleoli

Erythrocyte maturation

- The small amount of cytoplasm (about 20% of cell volume) contains polyribosomes actively involved in hemoglobin synthesis. The resulting cytoplasmic basophilia allows these cells to be distinguished from myeloblasts, with which they are most easily confused, proerythroblasts are capable of multiple mitoses and may be considered unipotent stem cells. 2. *Basophilic erythroblasts* are slightly smaller than proerythroblasts, with a diameter of 13—16 μm . They have slightly smaller nuclei with patchy chromatin. Their nucleoli are difficult to distinguish

Erythrocyte maturation

- The cytoplasm is more intensely basophilic, typically staining a deep royal blue. A prominent, clear, juxtannuclear cytocenter is often visible. Basophilic erythroblasts continue hemoglobin synthesis at a high rate and are capable of mitosis.
- 3. ***Polychromatophilic erythroblasts*** are smaller (12-15 µm in diameter), with significant amounts of hemoglobin beginning to accumulate in their cytoplasm. The conflicting staining affinities of the polyribosomes (basophilic) and hemoglobin (acidophilic) give the cytoplasm a trayish appearance.

Erythropoiesis

- The nucleus is smaller than in less mature cells, with more condensed chromatin that forms a checkerboard pattern. These cells can still synthesize hemoglobin and divide. 4. *Normoblasts (orthochromatophilic erythroblasts)* are easily identified because of their small size (8–10 μm in diameter); acidophilic cytoplasm with only traces of basophilia; and small, eccentrically placed nuclei with chromatin so condensed that it appears black. Although early normoblasts

-

The types of cells in Hematopoietic parenchyme

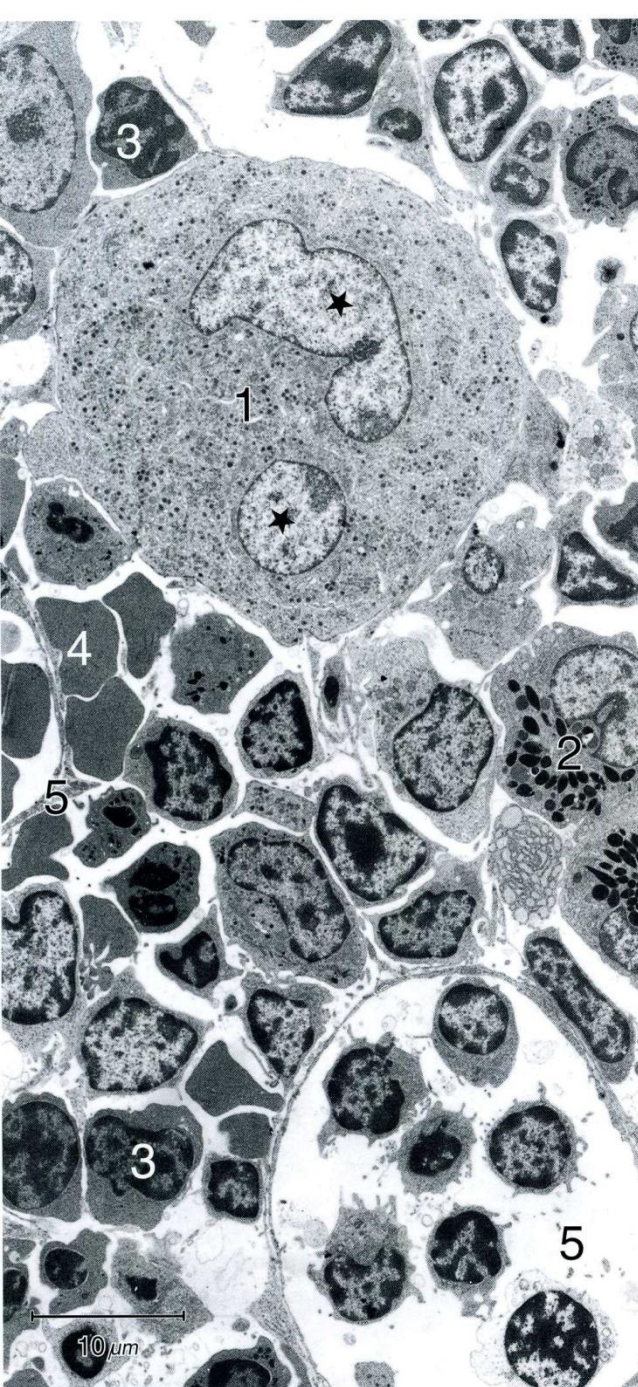

1- MEGOKARYOCYTE

**2. Myeloid hematopoietic
islets of Granulocytes**

3-4 Erythropoietic islets

**5. Sinusoidal capillary with
Lymphocytes**

Leukopoiesis

- **Leukopoiesis (*white blood cell formation*) encompasses both granulopoiesis and agranulopoiesis. Leukopoietic CFUs that have been identified include CFU-GM (forms both *granulocytes* and *macrophages*), CFU-G (forms all *granulocyte types*), CFU-M (*forms macrophages*), and CFU-Eo (forms only *eosinophils*). All these CFUs with limited capabilities derive from the pluripotential CFU-S.**
- **Granulopoiesis occurs in the bone marrow of healthy adults. The three types of granulocytes — *neutrophils*, *basophils*, and *eosinophils* — may all derive from a single precursor (CFU-G).**

Maturation of Granulocytes

- The structural changes include (1) decrease in cell size, (2) condensation of nuclear chromatin, (3) changes in nuclear
- shape (flattening ► indentation ► lobulation, a progression resembling the gradual deflation of a balloon), and (4) accumulation of cytoplasmic granules. Granulocyte maturation is commonly divided into 6 stages. These stages are identified by examining overall diameter; size, shape, and chromatin pattern in the nuclei; and type and number of specific granules in the cytoplasm

Granulopoiesis

FIGURE 13-8 Granulopoiesis: Formation of granules.

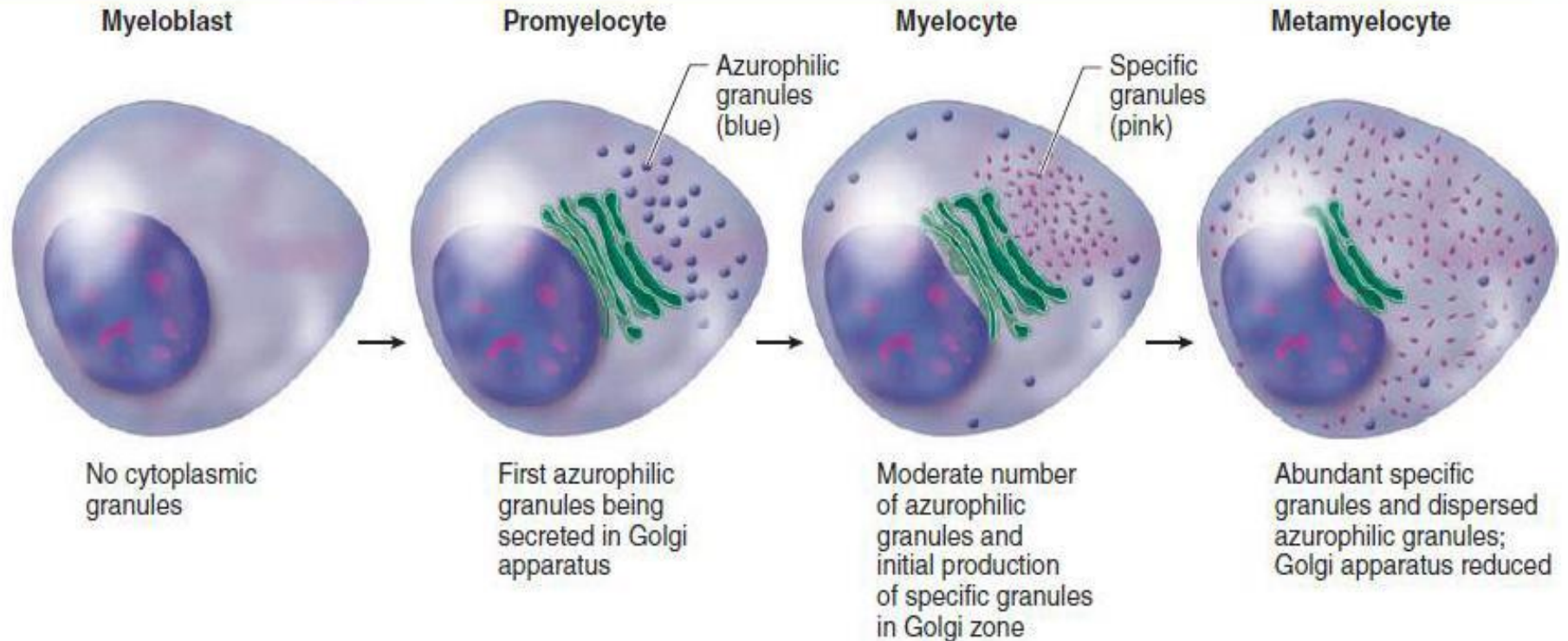

Illustrated is the sequence of cytoplasmic events in the maturation of granulocytes from **myeloblasts**. Modified lysosomes or azurophilic granules form first at the **promyelocyte** stage and are shown in blue; the specific granules of the particular cell type form at

the **myelocyte** stage and are shown in pink. All granules are fully dispersed at the **metamyelocyte** stage, when indentation of the nucleus begins.

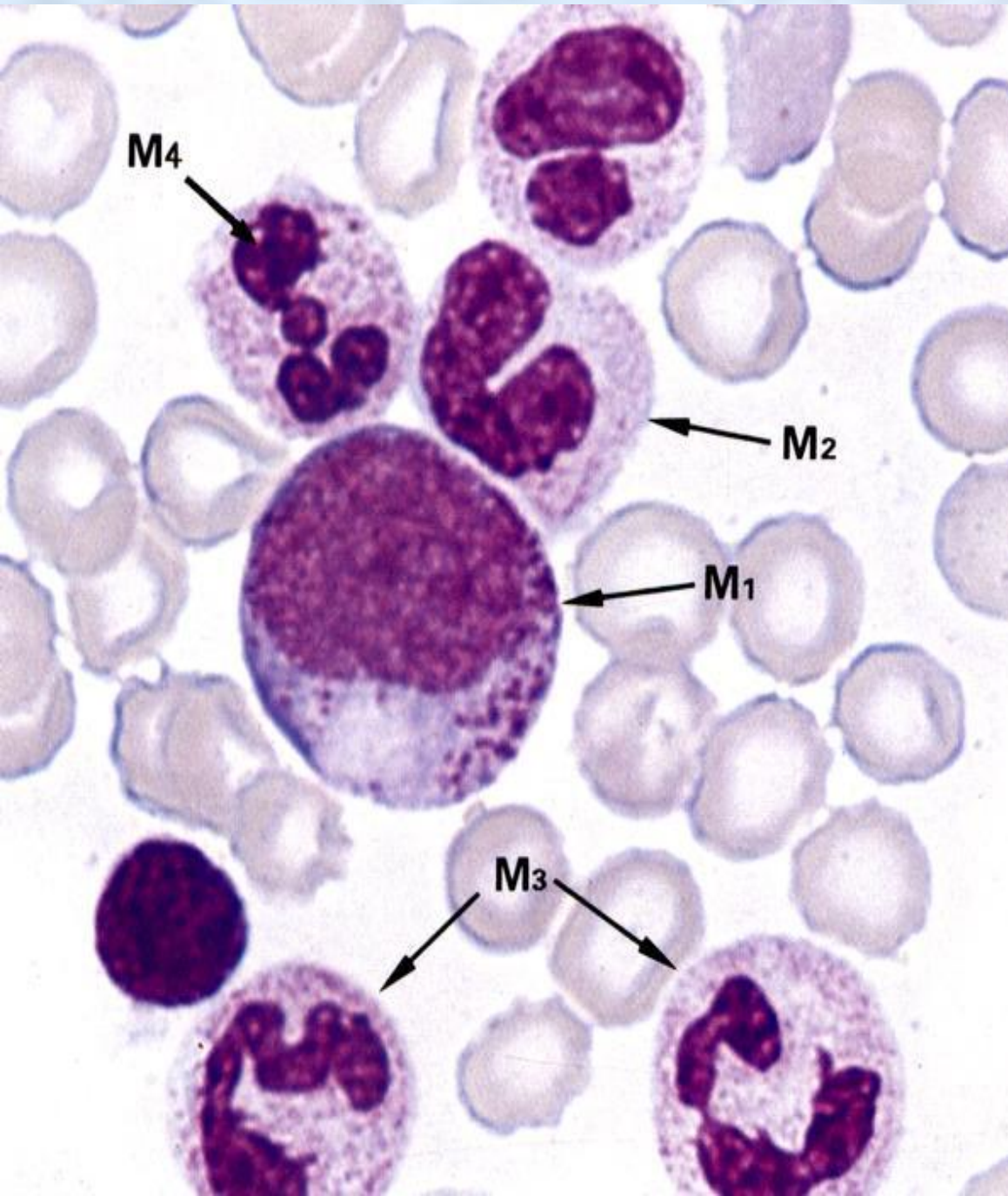

1. **Myeloblasts**, the earliest recognizable granulocyte precursors, are about 15 um in diameter.
2. **Promyelocytes** are larger than myeloblasts (15-24 um in diameter) and their chromatin is slightly more condensed
3. **Myelocytes** are typically smaller than promyelocytes (10-16 um in diameter). This is the first stage at which sufficient numbers of specific granules accumulate in the cytoplasm to allow one to distinguish the 3 immature granulocyte types — neutrophilic

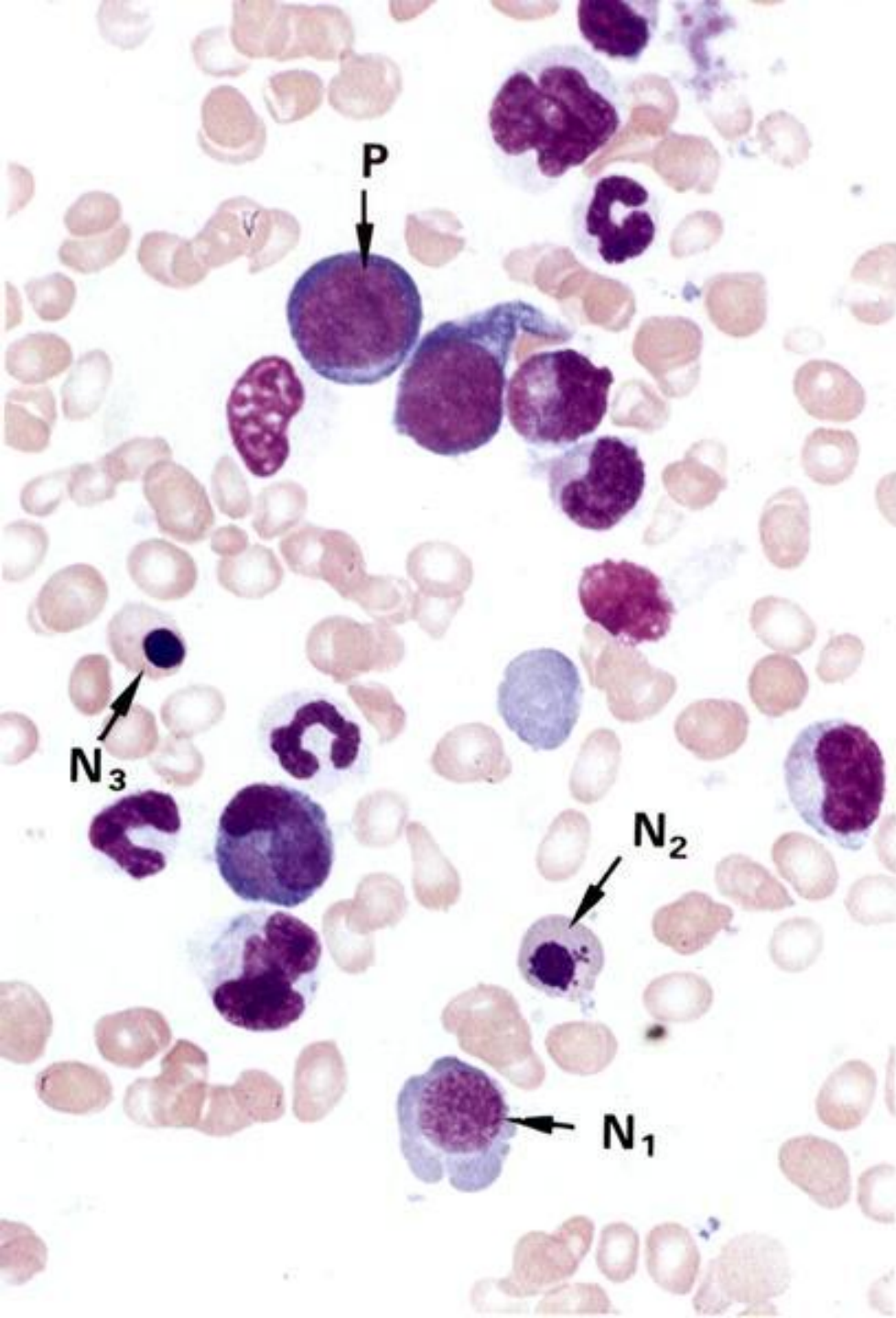

4. Metamyelocytes. The 3 types of metamyelocyte-neutrophilic metamyelocytes, eosinophilic metamyelocytes, and basophilic metamyelocytes are smaller (10—12 μm in diameter) and more densely packed with specific granules than their respective myelocyte precursors.

5. Band cells. The 3 band cell types — neutrophilic band, eosinophilic band, and basophilic band — have horseshoe-shaped nuclei. They range in diameter from 10 to 12 μm

6. Mature granulocytes, i.e., neutrophils, eosinophils, and basophils, are also found in the bone marrow.

Agranulopoiesis

- Agranulopoiesis: agranulocytes (*monocytes and lymphocytes*), like the other blood cell types, derive from CFU-Ss. The morphologic changes during maturation include a decrease in overall cell diameter, a decrease in nuclear diameter and an increase in nuclear heterochromatin content. However, the morphologic characteristics of agranulocytes at immature stages are much less distinct than those of erythrocytes and granulocytes

Monocytopoiesis

- **1. Monocytopoiesis.** The CFU derivatives that give rise to monocytes are called monoblasts and are difficult to identify in bone marrow smears. A product of the monoblast, ***the promonocyte***, is only slightly easier to identify and serves as the immediate precursor of monocytes. Promonocytes are larger (10-20 μm in diameter) than monocytes and have pale staining nuclei and basophilic cytoplasm. The similarity between monocyte precursors and other stem cells in the bone marrow makes identification difficult.

Lymphopoiesis

- **2. Lymphopoiesis.** In adults, lymphopoiesis occurs mainly in lymphoid tissues and organs and to a lesser extent in bone marrow. Prior to division, the precursor, or lymphoblast, is usually much larger than the typical circulating lymphocyte .
- However, many circulating lymphocytes can respond to antigenic stimulation by blasting (enlarging to assume the typical lymphoblast morphology), indicating that they are dormant stem cells. Some of these cells, **called null cells**, are neither T nor B cells and may represent a circulating form of the CFU-Ss.

Thrombopoiesis

- Thrombopoiesis. ***Platelet (thrombocyte)*** production is carried out in the bone marrow by unusually large cells (100 um in diameter) called ***megakaryocytes***. Immature megakaryocytes, called megakaryoblasts, derive from CFU-Megs, which in turn derive from CFU-Ss. Megakaryoblasts undergo successive incomplete mitoses involving repeated DNA replications without cellular or nuclear division

Maturation of Megakaryocyte

- The result of this process, *called endomitosis*, is a single large megakaryocyte with a single, large, multilobed, polyploid (up to $64n$) nucleus. Maturation involves lobulation of the nucleus and development of an elaborate demarcation membrane system that subdivides the peripheral cytoplasm, outlining cytoplasmic fragments destined to become platelets. As the demarcation membranes fuse to form the plasma membranes of the platelets, ribbon like groups of platelets are shed from the megakaryocyte periphery into the marrow sinusoids to enter the circulation

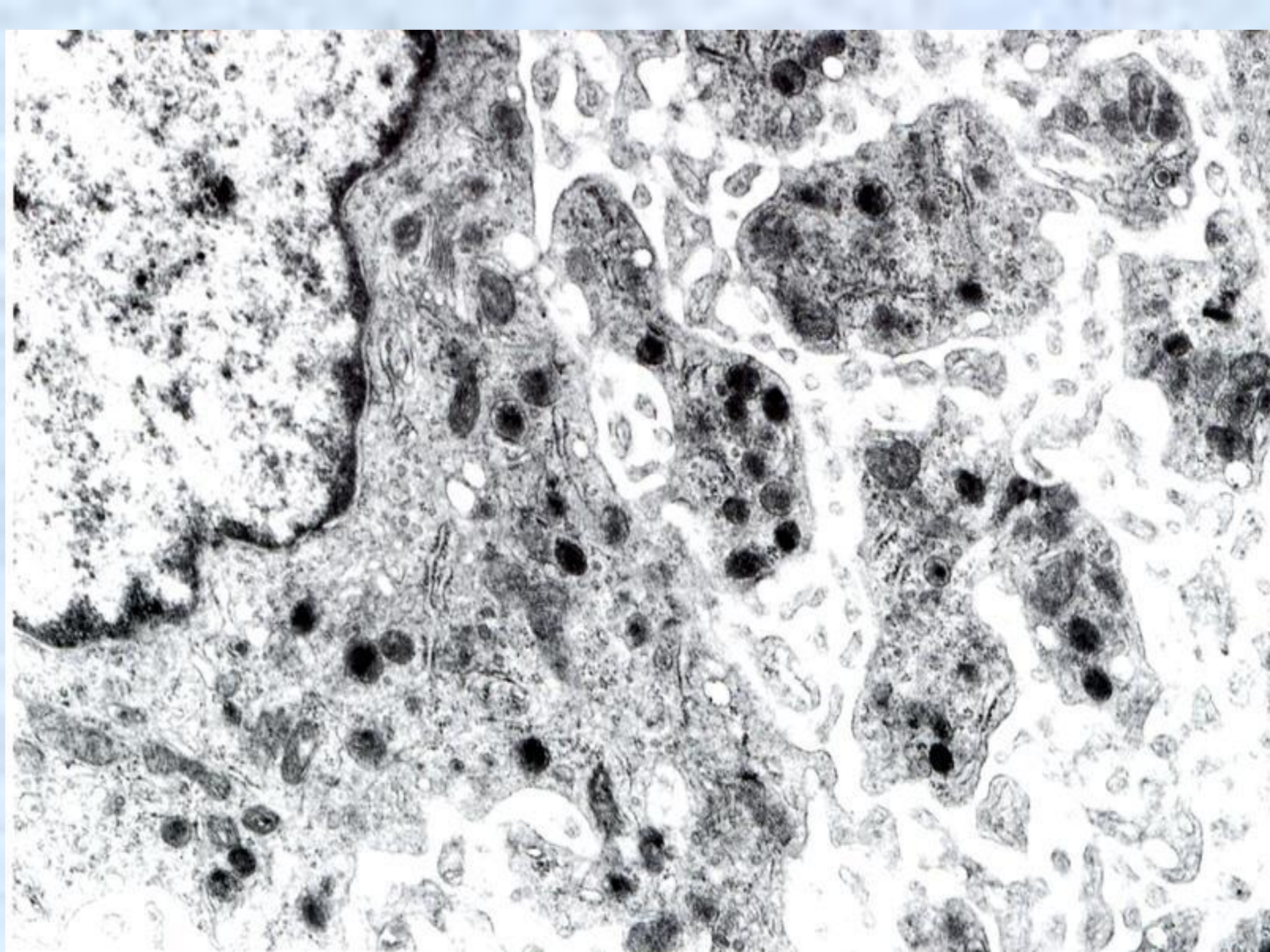

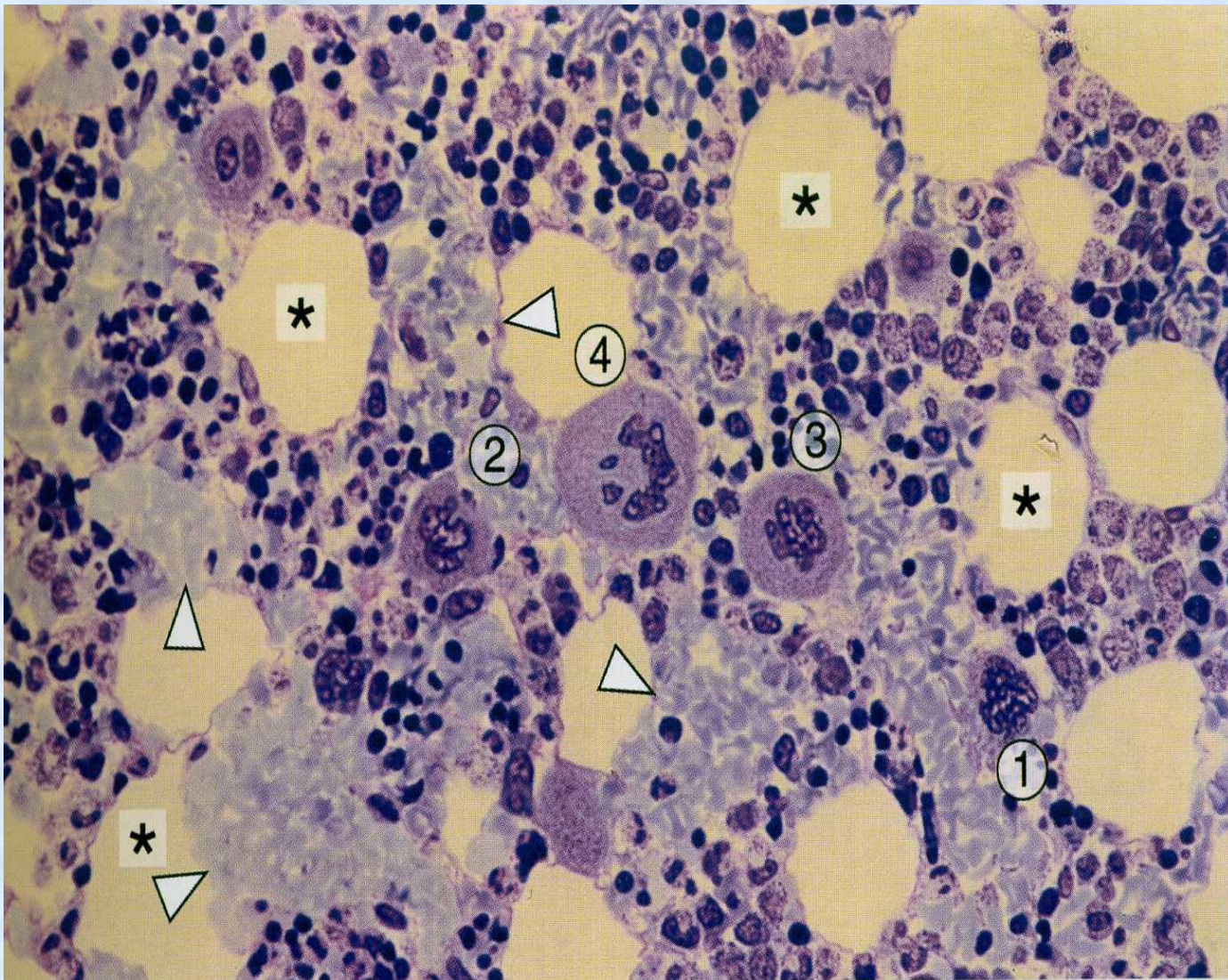

RED BONE MARROW with 1-2-3-4- stages of Trombocytopoisis in parencyme - * - Adipocytes, sinusoids

Regulation of hematopoiesis

- involves specific ***colony-stimulating factors (CSFs)*** such as ***erythropoietin, leukopoietin*** and ***thrombopoietin***. These hormones act at various steps in hematopoiesis to enhance proliferation and differentiation of CFUs.
- Some growth factors—principally three **interleukins (IL-1, IL-3, IL-6)**—stimulate proliferation of pluripotential and multipotential stem cells, thus maintaining their populations. Additional cytokines, granulocyte colony-stimulating factor (**G-CSF**), **IL-3, IL-7, IL-8, IL-11, IL-12, macrophage inhibitory protein- α** , and **erythropoietin**, are believed to be responsible for the mobilization and differentiation of these cells into unipotential progenitor cells

Erythropoietin/ Thrombopoietin

- CSFs are also responsible for the stimulation of cell division and for the differentiation of unipotential cells of the granulocytic and monocytic series. **Erythropoietin** activates cells of the erythrocytic series, whereas **thrombopoietin** stimulates platelet production. **Steel factor (stem cell factor)**, which acts on pluripotential, multipotential, and unipotential stem cells, is produced by stromal cells of the bone marrow and is inserted into their cell membranes. Stem cells must come in contact with these stromal cells before they can become mitotically active. It is believed that hemopoiesis cannot occur without the presence of cells that express stem cell factors, which is why postnatal blood cell formation is restricted to the bone marrow (and liver and spleen, if necessary).

Cell lineages

- Hemopoiesis is initiated in an apparent random manner when individual stem cells begin to differentiate into one of the blood cell lineages. Stem cells have surface receptors for specific cytokines and growth factors that influence and direct their proliferation and maturation into a specific lineage

INTERACTION OF IMMUNE CELLS

- The immune system of an organism consist of two basic ingredients: organs of a hemopoiesis and lymphoid organs (a red bone marrow, a thymus gland, a spleen, a lymph nodes) and immune cells, or immunocytes.
- Main function of immunocytes is to provide organism responses on **a specific** discernment and destruction (elimination) of an antigen.

lymphoid organs

- Typical immunocytes are T-and B-lymphocytes, macrophages and plasmocytes. The leading part in responses of artificial immunity belongs to lymphocytes as only they can **specificly recognize** a concrete antigen.
- All lymphoid tissues and organs produce lymphocytes. **In peripheral lymphoid organs** (lymph nodes, spleen, tonsils) and **unencapsulated lymphatic aggregates**, lymphocyte production is **antigen-dependent** and provides committed immunocompetent cells that respond to specific antigens.

Central lymphoid organs

- In **central lymphoid organs** (thymus, bone marrow, bursa of Fabricius [in birds]), lymphocyte production is **antigen-independent** and supplies uncommitted T-lymphocyte (thymus) or B-lymphocyte (bone marrow, bursa) precursors that subsequently move to peripheral organs and tissues. Mounting effective immune responses to new antigens requires ongoing production of uncommitted lymphocytes by the central lymphoid organs.

Cellular (cell-mediated) immunity.

- Activated T lymphocytes differentiate into specialized cell types, some of which (CD8+) contact and kill intruding cells, and some of which (CD4+) release **cytokines**, substances that enhance various aspects of the immune response. Cytokines are **interleukins (IL)**: IL 1, IL 4, IL 5, IL 6, interferons, the factor of a necrosis of tumour.

Humoral immunity

- Activated B lymphocytes differentiate into plasma cells that secrete antigen-binding **immunoglobulins (antibodies)**, which circulate in the blood and lymph.
- **Immunologic memory.** Lymphoid function in response to initial exposure to a particular infection protects an organism during subsequent exposure to the same infective agent.

Specificity

- **Specificity.** An ability to respond to one type of infection (chicken pox) does not imply resistance to another (tuberculosis).
- **Tolerance.** Antigen-disposal mechanisms directed toward the body's own cells (as occurs occasionally in **autoimmunity**) can be disastrous, even fatal. Thus, a key aspect of immune function is the ability to distinguish "self from "nonself" antigens, and to tolerate the self.

Lymphocyte programming and activation

- This multistep process is outlined below.
- 1. Cells of mesodermal origin are programmed in the bone marrow or thymus as B- or T-lymphocyte precursors, respectively.
- 2. These cells subsequently move to peripheral organs, where each encounters a specific antigen to which it becomes programmed (committed) to respond. The concentration of antigens on the surfaces of **antigen-presenting cells**, or the delivery of processed antigens to lymphocytes by macrophages, improves the efficiency of this step over that available from random lymphocyte-antigen collisions.

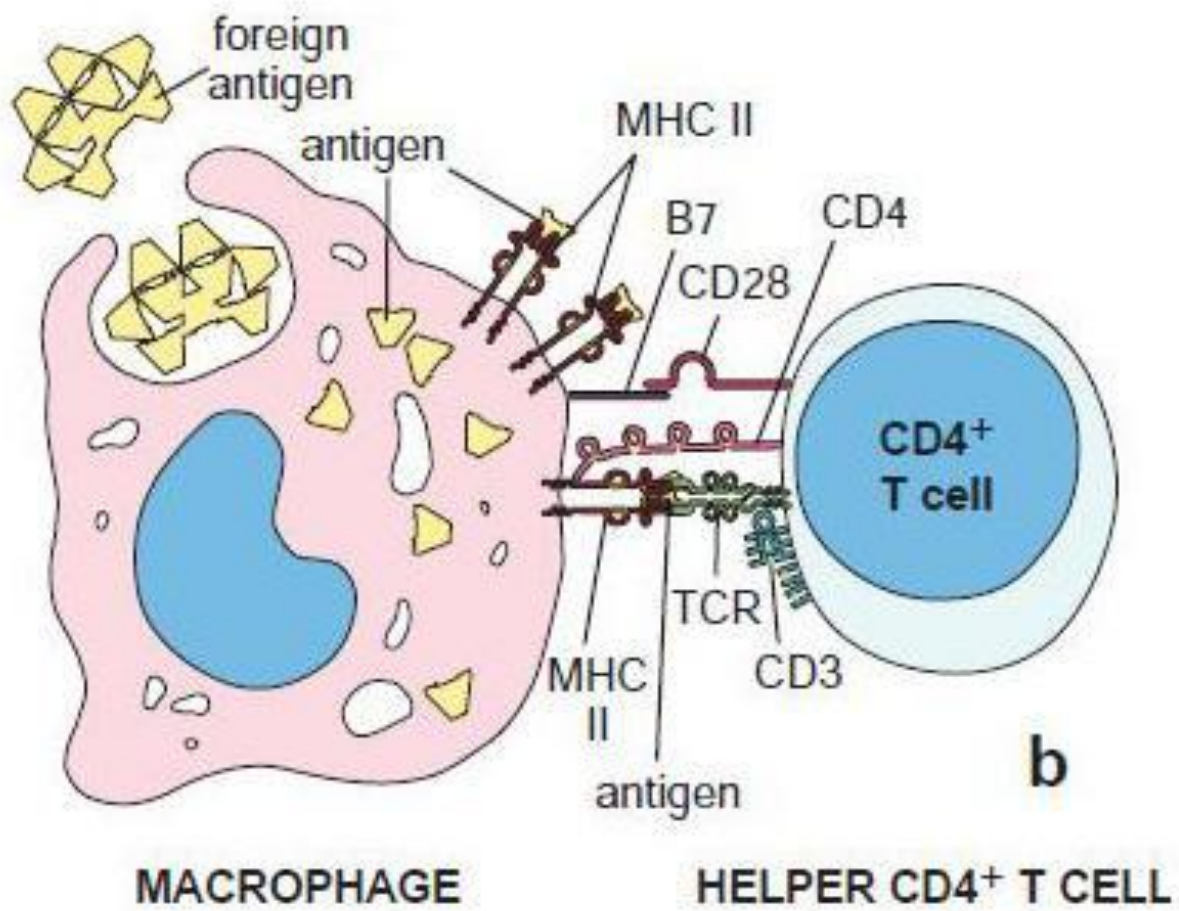

Selectively stimulation

- 3. Not all lymphocytes can respond to all antigens. Our ability to respond to a variety of antigens rests in the diversity of antigen-binding capabilities of virgin (preactivated) lymphocytes. It is estimated that lymphocytes able to bind more than a billion different antigens are present prior to any antigenic challenge. When such a challenge occurs, a lymphocyte able to bind the antigen is selectively stimulated to divide (activated).

Clonal expansion

- Activated cells enlarge and form lymphoblasts (**blast transformation**) and subsequently undergo a series of divisions (**clonal expansion**), forming a **clone** of cells competent to recognize that antigen. This process is termed **clonal selection**. Many immunocompetent lymphocyte clones may be generated in response to different parts of a single antigen.

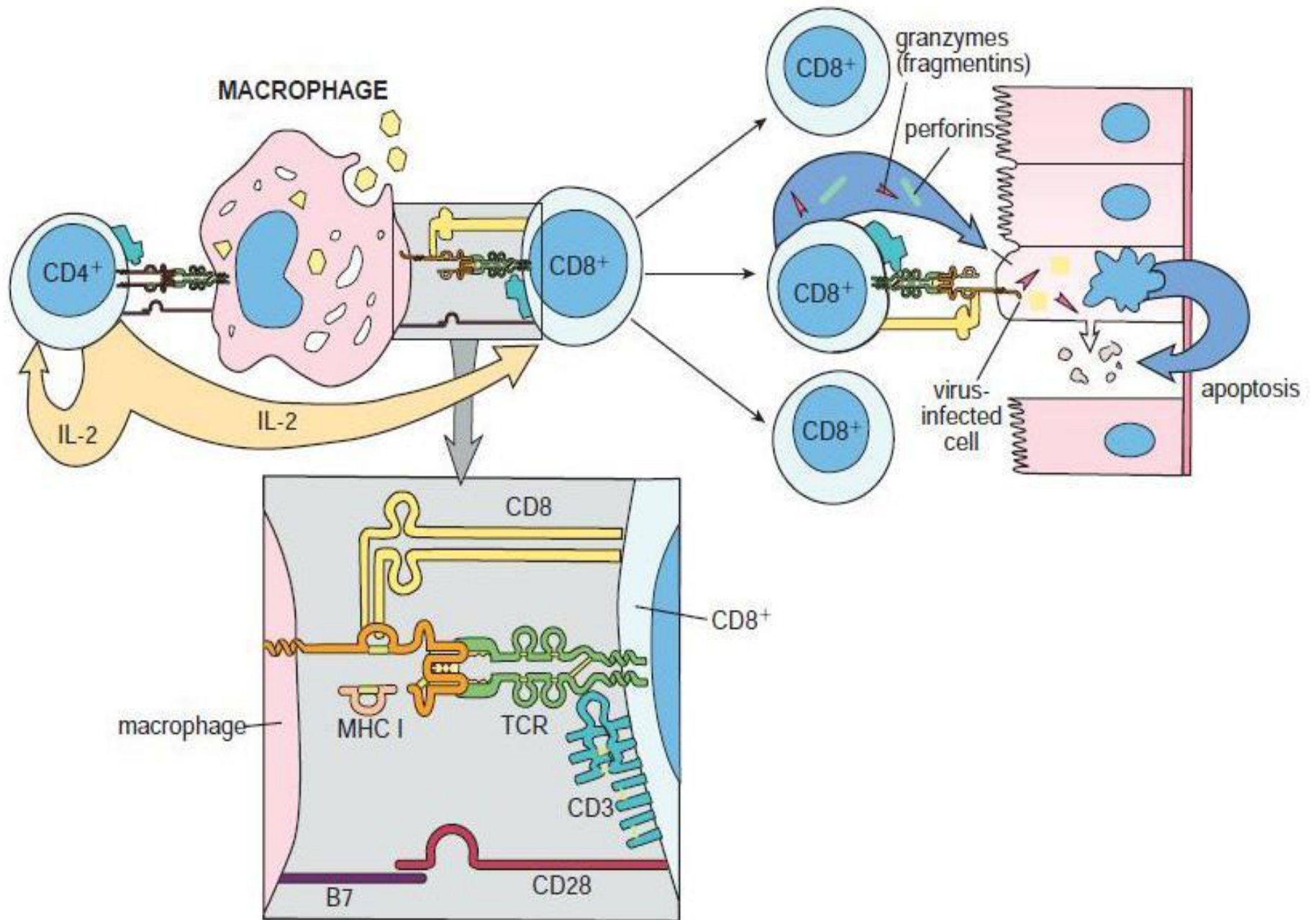

Secondary immune response

- 4. The products of this initial clonal expansion undergo **differentiation** into two basic cell types; **effector cells**, which immediately begin antigen disposal (**primary immune response**), and **memory cells**, which are held in reserve for subsequent encounters with the antigen (**secondary immune response**). T-lymphocyte derivatives form three main effector cell types, which enter the circulation and search the body for their antigens, providing cellular immunity. B-lymphocyte derivatives form

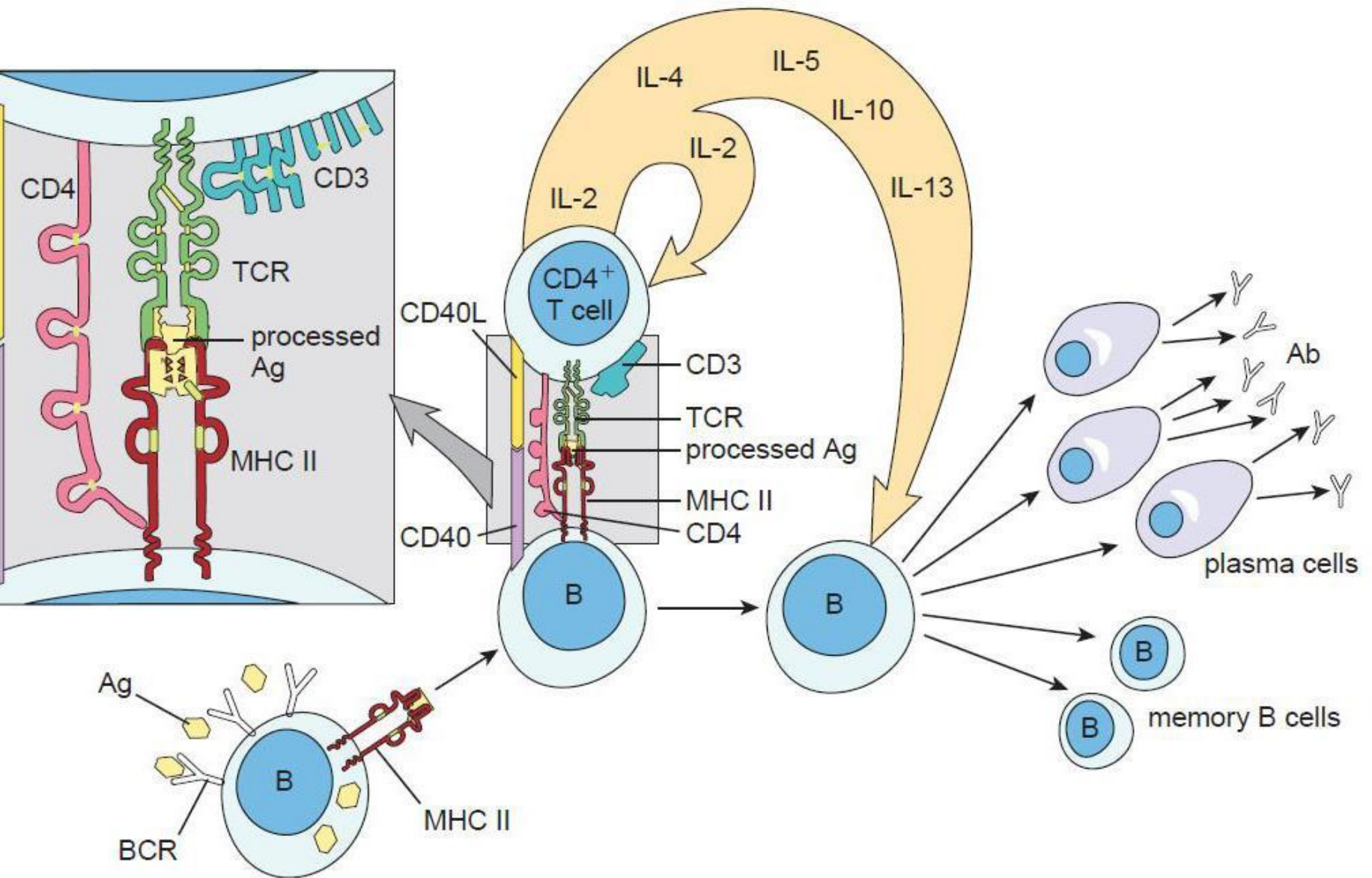

Clonal expansion and differentiation of B-lymphocytes and Plasma cells

- 5. When the same antigen is again encountered, memory cells generated during the initial clonal selection and expansion (either T or B) undergo the same process—blast transformation, clonal expansion and differentiation—that occurs during the primary response, but more rapidly (with a shorter lag time between exposure and response) and more effectively (owing to the increased number of responsive cells, and the greater affinity of the antibodies) than before.

Antigens

- These are foreign (nonself) substances that are able to elicit an **immune response** (cellular, humoral, or both). They can be entire cells (bacteria, tumor cells) or large molecules (proteins, polysaccharides, nucleoproteins). Their **antigenicity** is determined by several factors: larger and more complex (branched or folded) molecules are more potent antigens than smaller, simpler ones; proteins are more antigenic than carbohydrates; and lipids are nonantigenic unless complexed with a more potent antigen. Particularly potent antigens are said to be immunodominant. The site of entry of an antigen into the body also can affect its antigenicity.

- The specific part of an antigen that elicits the immune response (and to which the antibodies bind) is called an antigenic determinant, or **epitope**; it can consist of a monosaccharide or as few as four to six amino acids. Thus a bacterium can have many antigenic determinants and elicit many cellular and humoral responses.

Immunoglobulins (Ig)



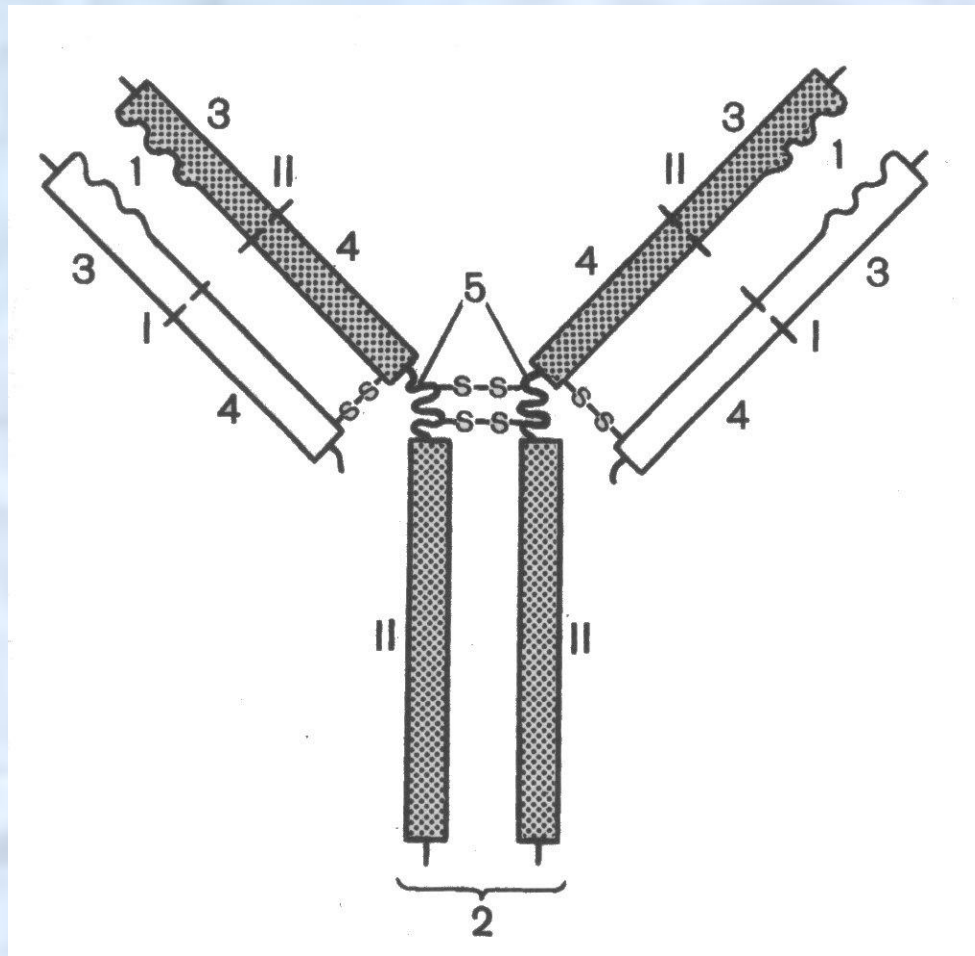

- These antibodies are proteins secreted by plasma cells into body fluids (blood, lymph, tissue fluid, saliva, tears, milk, mucus) in response to antigenic stimulation. They bind with high affinity to the antigenic determinants that elicited their production and make up most of the blood's gamma-globulins.
- Immunoglobulins (antibodies) are immune protective proteins. Everyone Ig has rigorous specificity to concrete antigen. Exist in two forms: a) as membranous receptors of a B-lymphocytes; б) as the antibodies loosely circulating in a blood plasma and a lymph.



- Fig. 47. Structure of immunoglobulin molecule (by Alberts et al.).
- I - light chain; II - heavy chain; 1 - Fab-fragment; 2 - Fc-fragment; 3 - variable domains; 4 - constant domains; 5 – disulfide bridges.

TABLE 14-2

Important features of the antibody classes in humans.

	IgG	IgM	IgA	IgD	IgE
Structure			 Secretory component		
	Monomer	Pentamer	Dimer with J chain and secretory component	Monomer	Monomer
Antibody percentage in the plasma	75%-85%	5%-10%	10%-15%	0.001%	0.002%
Presence in sites other than blood, connective tissue, and lymphoid organs	Fetal circulation in pregnant women	B lymphocyte surface (as a monomer)	Secretions (saliva, milk, tears, etc)	Surface of B lymphocytes	Bound to the surface of mast cells and basophils
Known functions	Activates phagocytosis, neutralizes antigens	First antibody produced in initial immune response; activates complement	Protects mucosae	Antigen receptor triggering initial B cell activation	Destroys parasitic worms and participates in allergies

The mechanism of cytolytic activity of the T-killer (T-cytotoxic lymphocyte) on a cell - target.

- T - cytotoxic lymphocyte is effector of cellular immunodefence. Cytotoxic (cytolytic) responses is effector immune mechanisms direct on elimination of cells which are too large for a phagocytosis by routine phagocytes (neutrophils). The cell of an antigen (a bacterium, a cancer cell, cell with virus) is a cell - target for the T-killer. The cell with virus contains a complex consisting of the MHC 1 and virus peptides on the plasmolemma. The T-killer with help of TCR recognize an antigenic peptide, and with the help of receptor CD8 finds out a molecula of the MHC 1. Thus the T-killer forms with a cell - target strong communication. Then the T-killer secrete from the granules proteins **perforin** and **granzims**. Perforin invokes pores and ion channels in a plasmolemma of a target cell. Through pores inside of a cell - target water starts to come uncontrolledly and it bursts. Besides through pores go to cytoplasm granzims (major of them granzim B). They include in a nucleus of a cell - target the mechanism of apoptosis (genetical programmed destruction of a cell). As a result of an apoptosis activation the cell - target blasts itself. After a secretion of perforin and granzim T-cytotoxic lymphocyte is disconnected from a target and searches for a new antigen to manufacture new cytolysis.

Plasma cells (plasmocytes)

- are differentiated B-lymphocyte effector cells secrete the Igs primarily responsible for humoral immunity. Their morphology includes a "clock face" nucleus, basophilic cytoplasm and abundant rough endoplasmic reticulum typical of protein-secreting cells. Plasma cells, found in all lymphoid tissues and loose connective tissue, occur in high concentration in the medullary cords of lymph nodes, the red pulp cords in the spleen, and the lamina propria under mucosal and glandular epithelia. They are rare in the thymus, occurring only in the medulla. Each plasma cell secretes only one class of Ig that binds only one antigen.

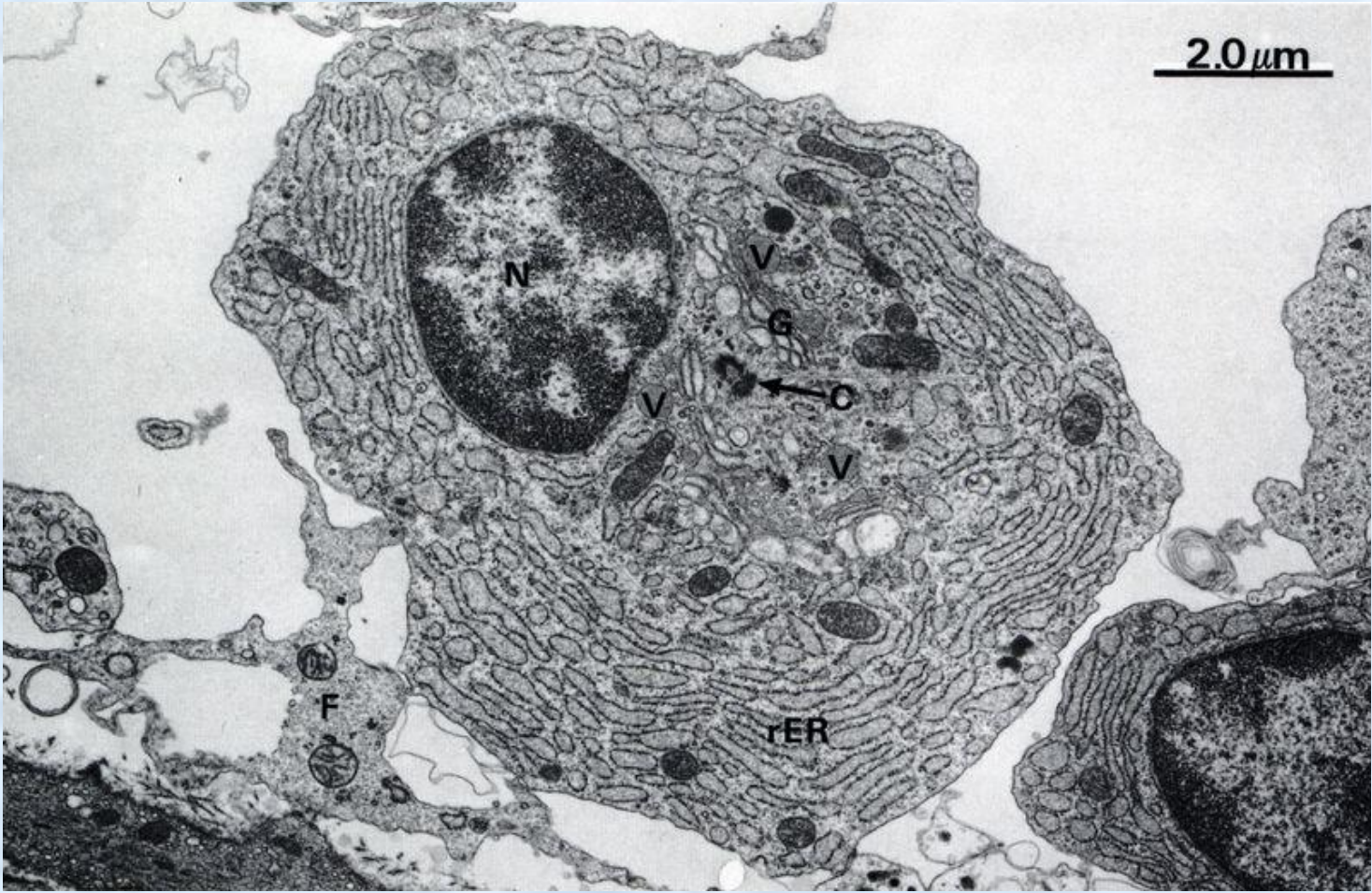

Function	T cell	B cell
-----------------	---------------	---------------

Antigen receptor	TCR	sIg
------------------	-----	-----

Accessory binding molecules	CD4 (T_H)	CD19
	CD8 (T_C)	
	CD2	
	CD28	CD40

Signal transduction	CD3	sIg
---------------------	-----	-----

Other	CD25	CR2
-------	------	-----

THANK YOU

