

Мікропроцесорна техніка

(лекція 2)

Благітко Б.Я.
2019 р.

PSoC Creator 4.2
Designing with PSoC 3/5



PSoC@3/5 PWM

PSoC Creator 4.2
Designing with PSoC 3/5



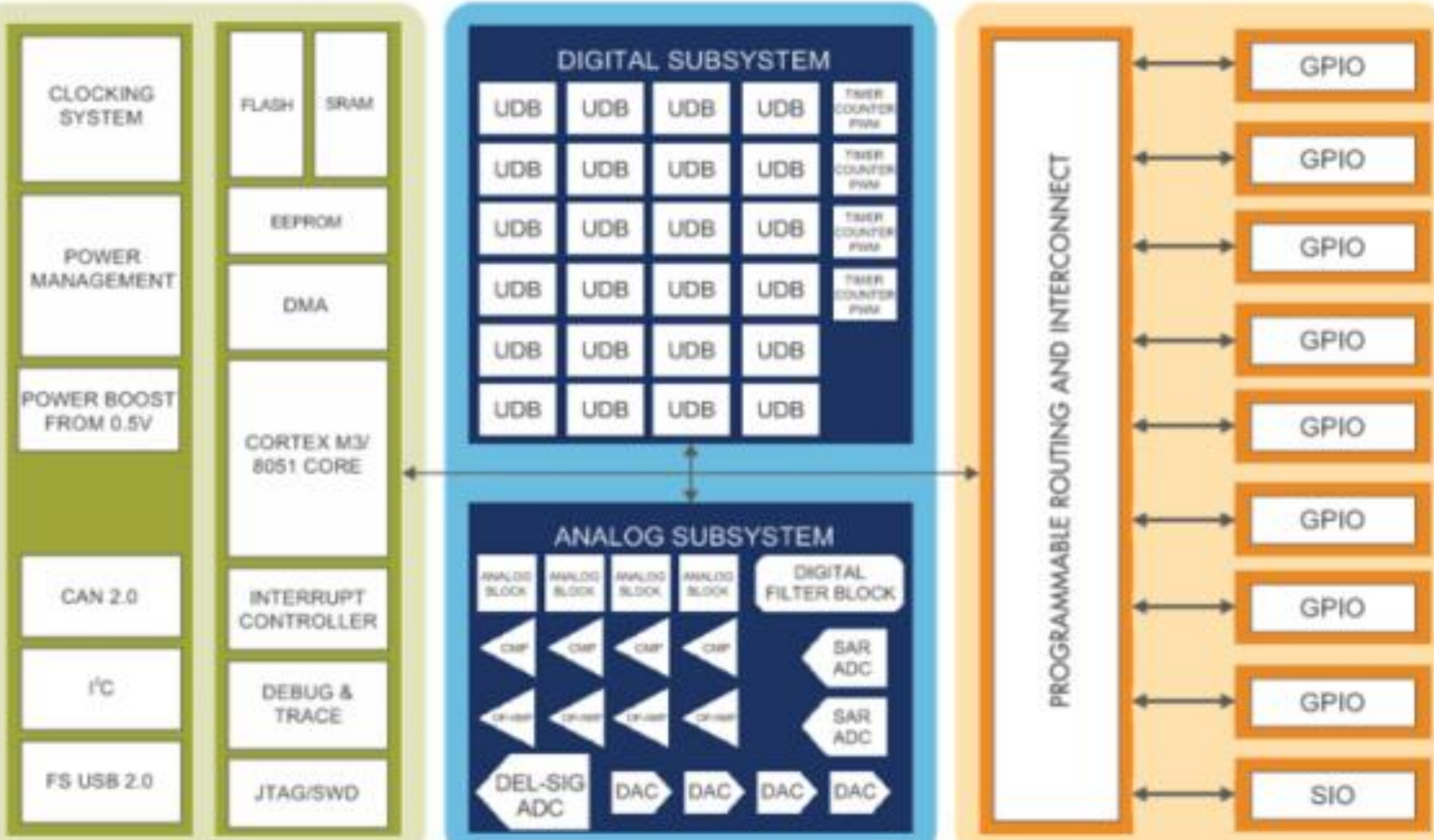

Figure 1-1. Simplified Block Diagram

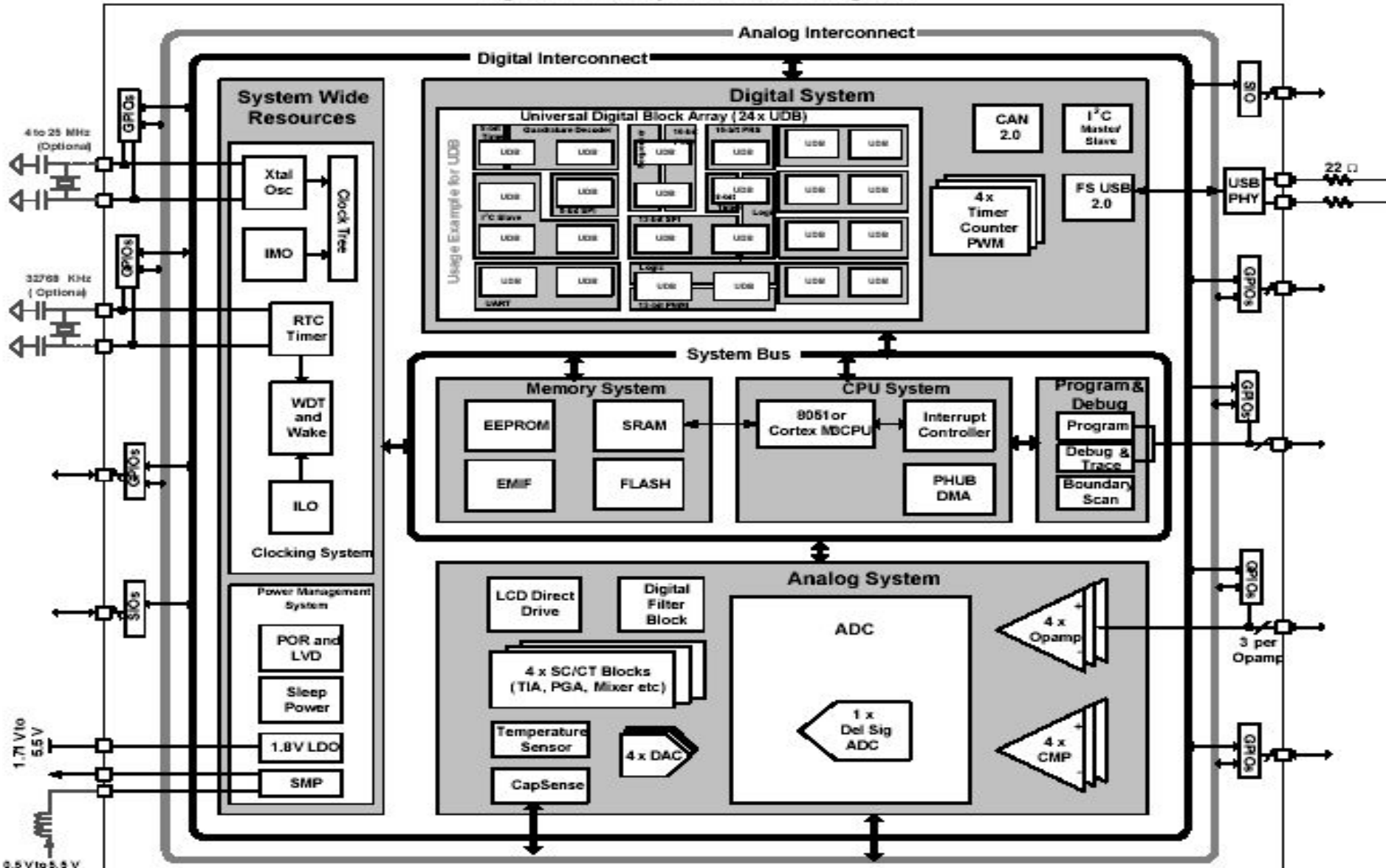

Figure 7-1. CY8C38 Digital Programmable Architecture

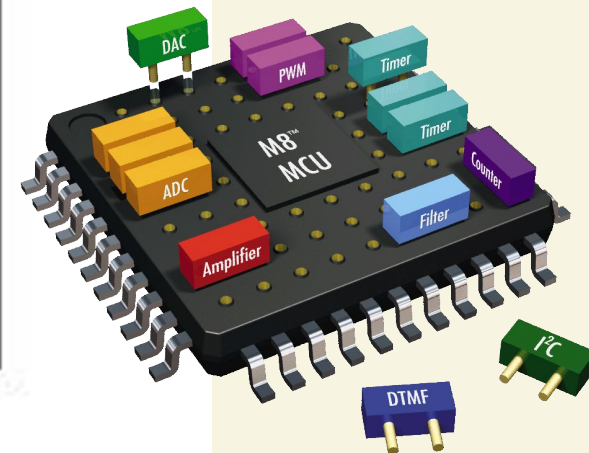
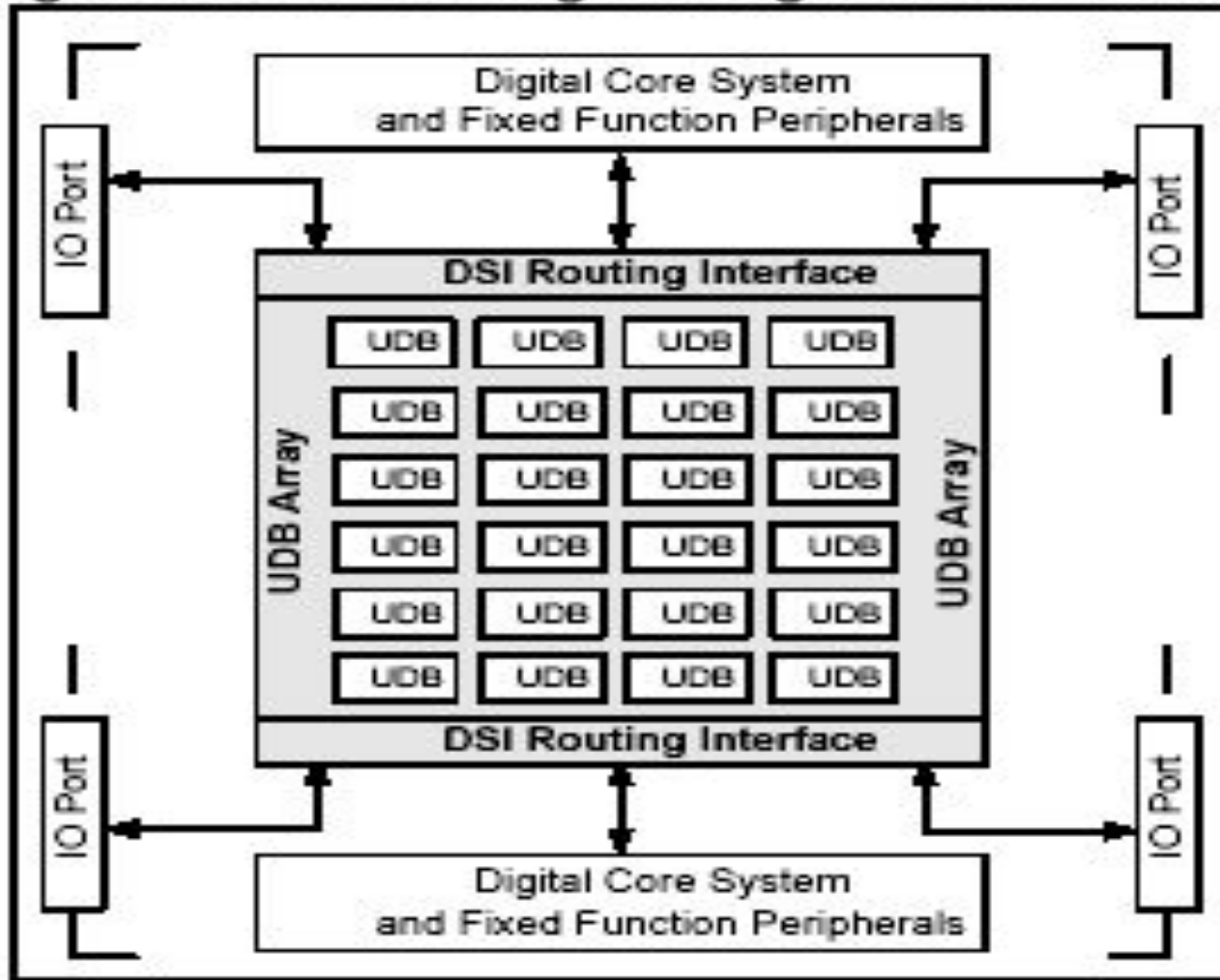
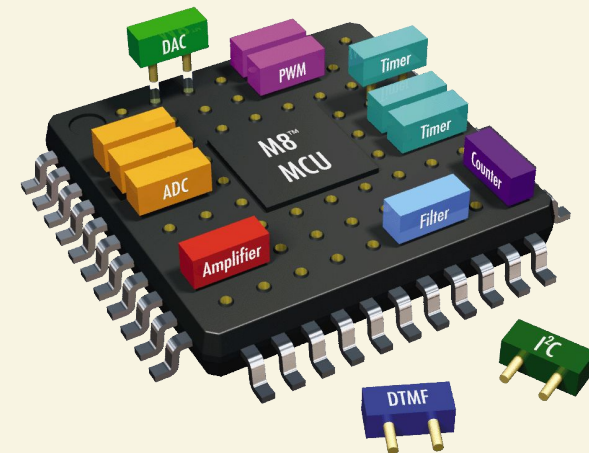
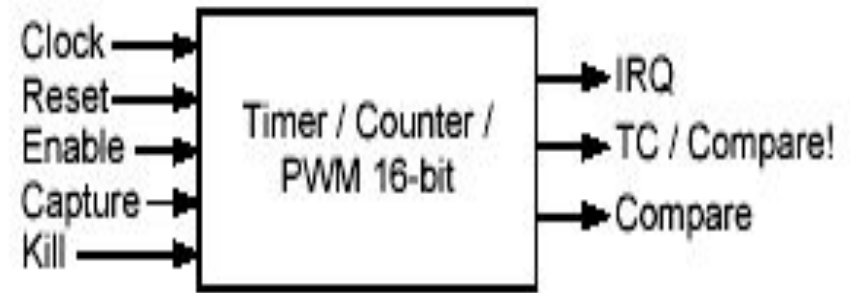

Figure 7-3. Component Catalog



Figure 7-21. Timer/Counter/PWM





PWMs, Timers and Counters share many capabilities but each provides specific capabilities.

When to Use a PWM

The most common use of the **PWM** is to generate periodic waveforms with adjustable duty cycles. The PWM also provides optimized features for power control, motor control, switching regulators and lighting control. The PWM can also be used as a clock divider by driving a clock into the clock input and using the terminal count or a PWM output as the divided clock output.



When to Use a Counter

A **Counter** component is better used in situations that require the counting of a number of events but also provides rising edge capture input as well as a compare output.

When to Use a Timer

A **Timer** component is better used in situations focused on timing the length of events, measuring the interval of multiple rising and/or falling edges, or for multiple capture events.

PWM

Output	May Be Hidden	Description
tc	N	The terminal count output is '1' when the period counter is equal to zero. In normal operation this output will be '1' for a single cycle where the counter is reloaded with period. If the PWM is stopped with the period counter equal to zero then this signal will remain high until the period counter is no longer zero. This output is synchronized to the block clock input of the component.
interrupt	Y	The interrupt output is the logical OR of the group of possible interrupt sources. This signal will go high while any of the enabled interrupt sources are true. The interrupt output shall remain asserted until the Status Register is read out by the software. In order to receive subsequent interrupts, the interrupt shall be cleared by reading the Status Register using the PWM_ReadStatusRegister() API. The interrupt output is not visible if the Use Interrupt parameter is not set. This allows the status register to be removed for resource optimization as necessary.
pwm/pwm1	Y	The pwm or pwm1 output is the first or only pulse width modulated output. This signal is defined by PWM Mode, compare modes(s), and compare value(s) as indicated in waveforms in the Configure dialog. When the instance is configured in one output, Dual Edged, Hardware Select, Center Aligned, or Dither PWM Modes, then the output "pwm" is visible. Otherwise the output "pwm1" is visible with "pwm2" the other pulse width signal. This output is synchronized to the block clock input of the component.

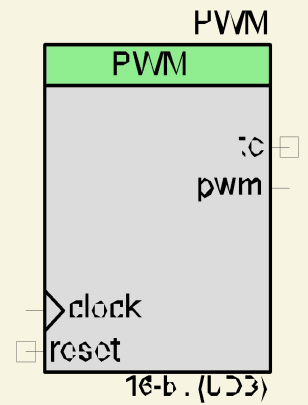
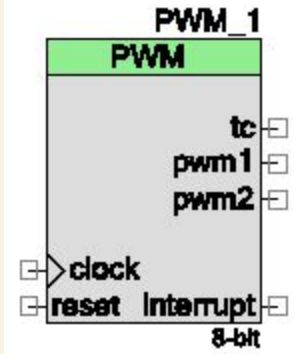
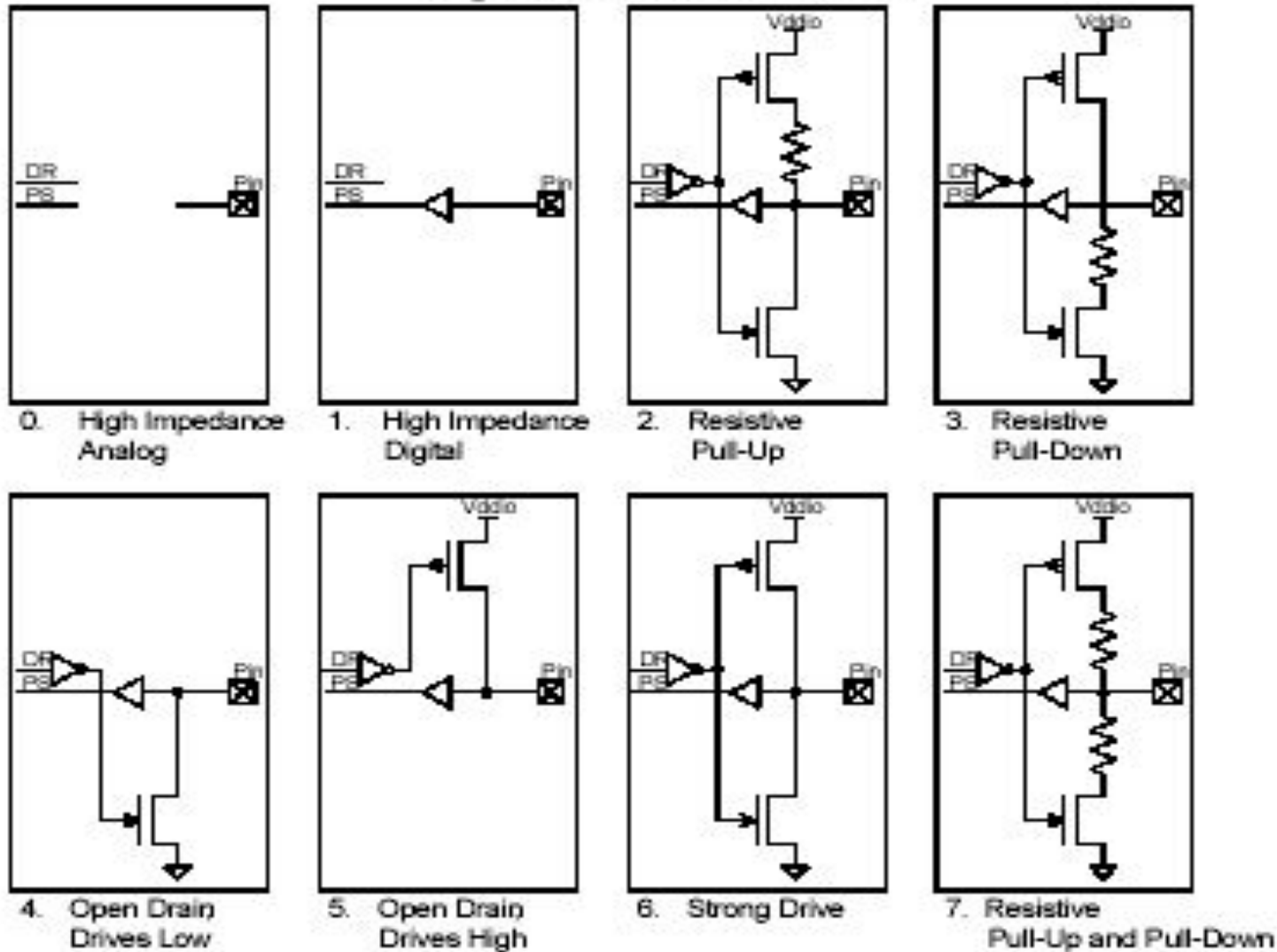

Figure 6-11. Drive Mode



PSoC Creator 2.1

File Edit View Debug Project Build Tools Window Help

Workspace Explorer

Source Components Datasheets Results

Start Page

PSoC® Creator™



Recent Projects

- HelloWorld_Blinky01.cywrk
- CapSense_CSD_Design01...
- CapSense_CSD_Design01...
- CharLCD_CustomFont01.c...
- CharLCD_CustomFont01.c...

Create New Project...
Open Existing Project...

Getting Started

- PSoC Creator Start Page
- Quick Start Guide
- Intro to PSoC
- Intro to PSoC Creator
- PSoC Creator Training
- Help Tutorials
- Getting Started With PSoC 3
- Getting Started With PSoC 5

Examples and Kits

- Find Example Project...
- No Kit Packages Installed

简体中文 日本語 한국어 English

PSoC Creator News and Information

Happy Lunar New Year!
Posted on 02/11/2013

Gong Xi Fa Cai! As many of my friends and colleagues are celebrating the New Year and welcoming in the year of the water snake, I wanted to take a minute and wish you all well. May the New Year bring each of you prosperity, good luck and a new PSoC design.
[Read More](#)

Tips + Tricks: Menu Customization
Posted on 01/24/2013

Did you know you can create a customized menu in PSoC® Creator? Right click in a blank area of the top menu and select customize from the

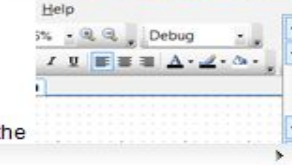
Notice List

0 Errors 0 Warnings

De... File Error L

Output

Show output from: All

Log file for this session is located at: C:\Documents and Settings\Admin.MICROSOFT-7D0472\Local Se

File – New - Projekt

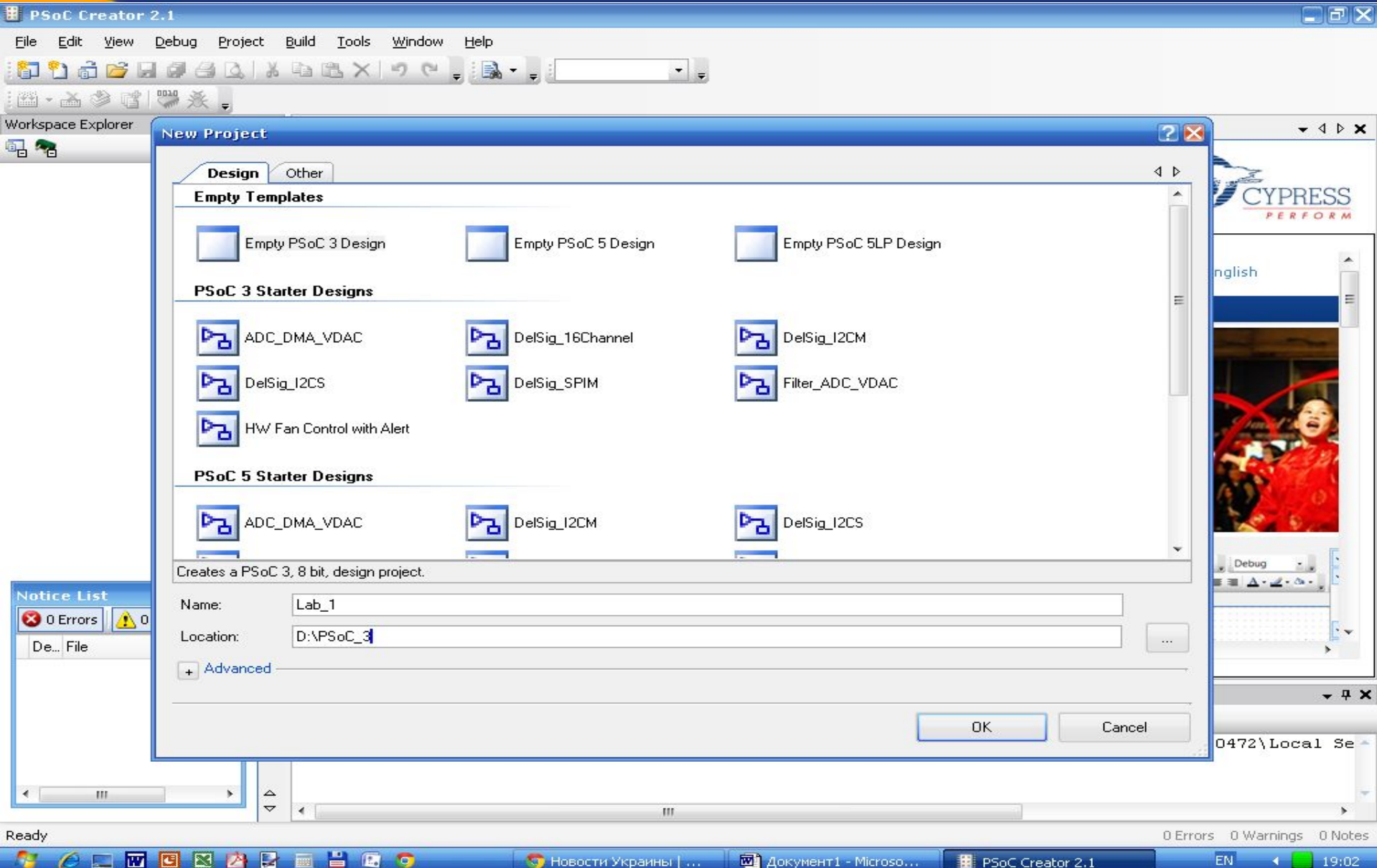

The screenshot displays the PSoC Creator 2.1 application window. The main menu bar includes File, Edit, View, Debug, Project, Build, Tools, Window, and Help. The toolbar contains various icons for file operations and project management. The 'New Project' dialog box is open, showing the 'Design' tab. It lists several project templates under three categories: 'Empty Templates', 'PSoC 3 Starter Designs', and 'PSoC 5 Starter Designs'. The 'Name' field is set to 'Lab_1' and the 'Location' field is set to 'D:\PSoC_3'. The 'Advanced' options are expanded. The 'Notice List' panel on the left shows '0 Errors' and '0 Warnings'. The status bar at the bottom indicates 'Ready' and '0 Errors 0 Warnings 0 Notes'. The Windows taskbar at the bottom shows the system tray with the date and time '19:02'.

PSoC Creator 2.1

File Edit View Debug Project Build Tools Window Help

Workspace Explorer

New Project

Design Other

Empty Templates

- Empty PSoC 3 Design
- Empty PSoC 5 Design
- Empty PSoC 5LP Design

PSoC 3 Starter Designs

- ADC_DMA_VDAC
- DelSig_16Channel
- DelSig_I2CM
- DelSig_I2CS
- DelSig_SPIM
- Filter_ADC_VDAC
- HW Fan Control with Alert

PSoC 5 Starter Designs

- ADC_DMA_VDAC
- DelSig_I2CM
- DelSig_I2CS

Creates a PSoC 3, 8 bit, design project.

Name: Lab_1

Location: D:\PSoC_3

+ Advanced

OK Cancel

Notice List

0 Errors 0 Warnings

De... File

Ready

0 Errors 0 Warnings 0 Notes

EN 19:02

Empty PSoC 3 Design

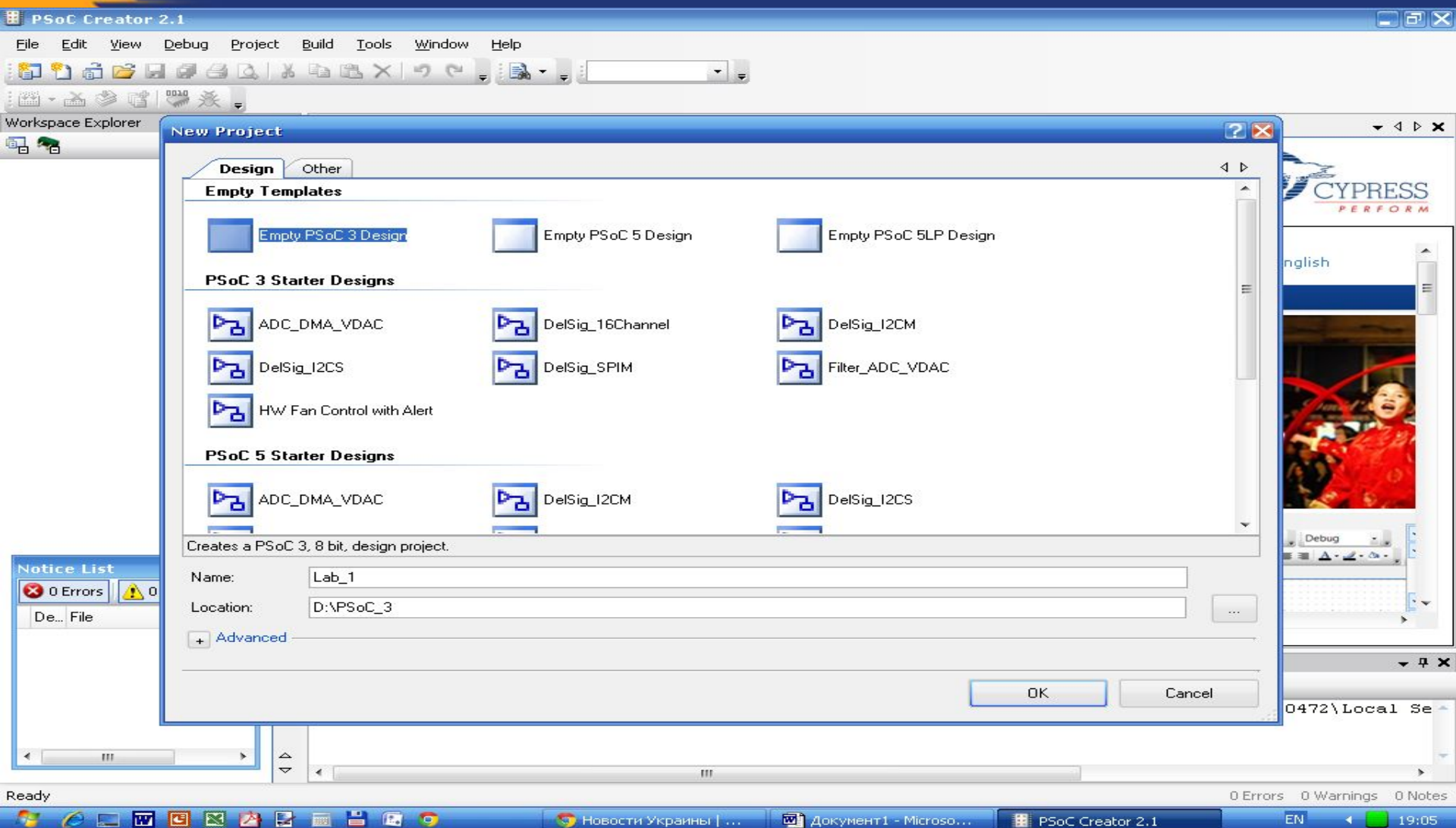

PSoC Creator 2.1

File Edit View Debug Project Build Tools Window Help

Workspace Explorer

New Project

Design Other

Empty Templates

- Empty PSoC 3 Design
- Empty PSoC 5 Design
- Empty PSoC 5LP Design

PSoC 3 Starter Designs

- ADC_DMA_VDAC
- DelSig_16Channel
- DelSig_I2CM
- DelSig_I2CS
- DelSig_SPIM
- Filter_ADC_VDAC
- HW Fan Control with Alert

PSoC 5 Starter Designs

- ADC_DMA_VDAC
- DelSig_I2CM
- DelSig_I2CS

Creates a PSoC 3, 8 bit, design project.

Name:

Location: ...

Advanced

OK Cancel

Notice List

- 0 Errors
- 0 Warnings
- 0 Notices

0472\Local Se

Ready

0 Errors 0 Warnings 0 Notes

EN 19:05

Lab_2 PWM

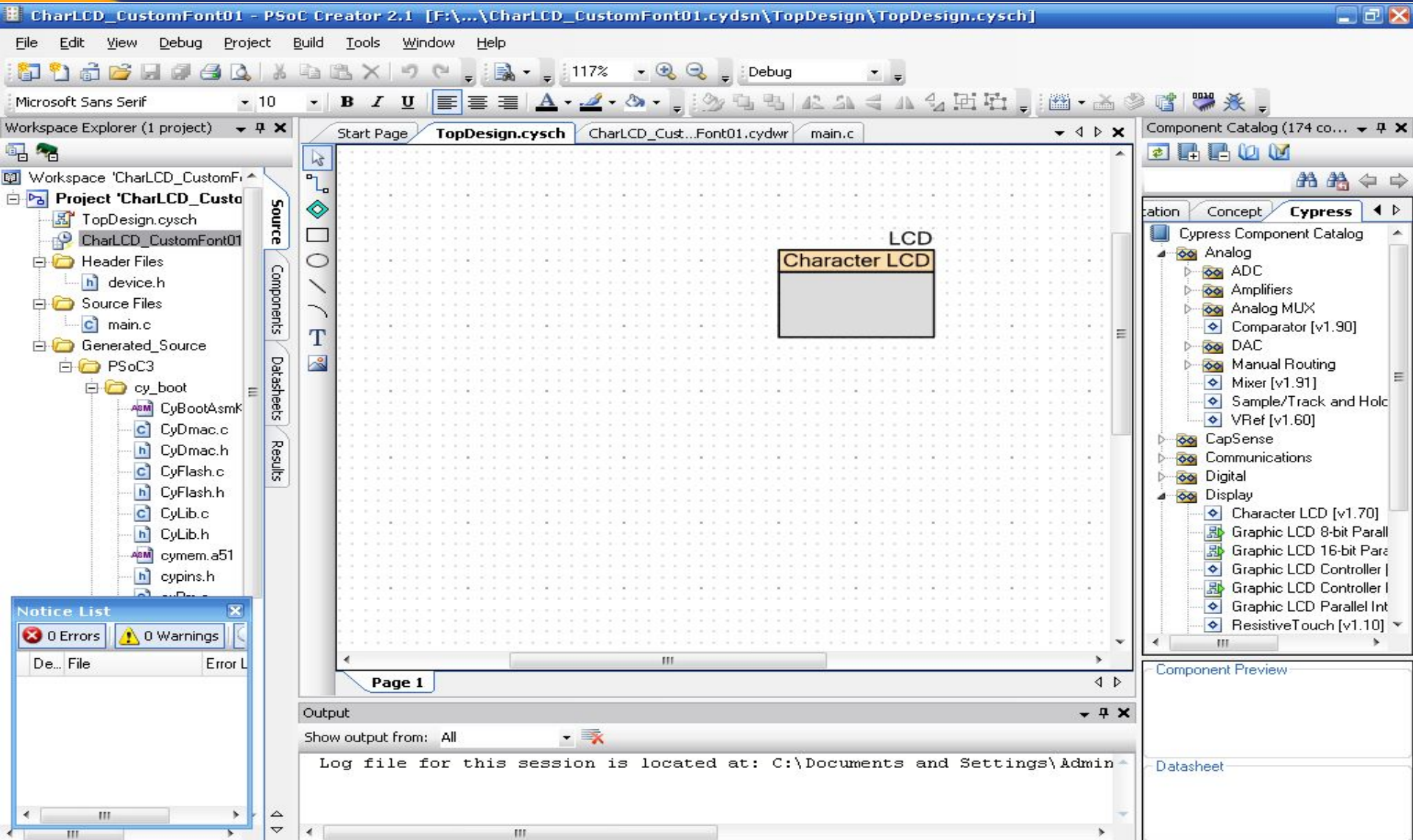

CharLCD_CustomFont01 - PSoC Creator 2.1 [F:\...\CharLCD_CustomFont01.cydsn\TopDesign\TopDesign.cysch]

File Edit View Debug Project Build Tools Window Help

Microsoft Sans Serif 10 B I U

Workspace Explorer (1 project)

Project 'CharLCD_CustomFont01'

- TopDesign.cysch
- CharLCD_CustomFont01
 - Header Files
 - device.h
 - Source Files
 - main.c
 - Generated_Source
 - PSoC3
 - cy_boot
 - CyBootAsmk
 - CyDmac.c
 - CyDmac.h
 - CyFlash.c
 - CyFlash.h
 - CyLib.c
 - CyLib.h
 - cymem.a51
 - cypins.h

Start Page TopDesign.cysch CharLCD_Cust...Font01.cydwr main.c

LCD
Character LCD

Component Catalog (174 co...)

Cypress Component Catalog

- Analog
 - ADC
 - Amplifiers
 - Analog MUX
 - Comparator [v1.90]
 - DAC
 - Manual Routing
 - Mixer [v1.91]
 - Sample/Track and Hold
 - VRef [v1.60]
- CapSense
- Communications
- Digital
- Display
 - Character LCD [v1.70]
 - Graphic LCD 8-bit Paralle
 - Graphic LCD 16-bit Paralle
 - Graphic LCD Controller I
 - Graphic LCD Parallel Int
 - Resistive Touch [v1.10]

Notice List

0 Errors 0 Warnings

De... File Error L

Output

Show output from: All

Log file for this session is located at: C:\Documents and Settings\Admin...

Page 1

0 Errors 0 Warnings 0 Notes

Configure LCD

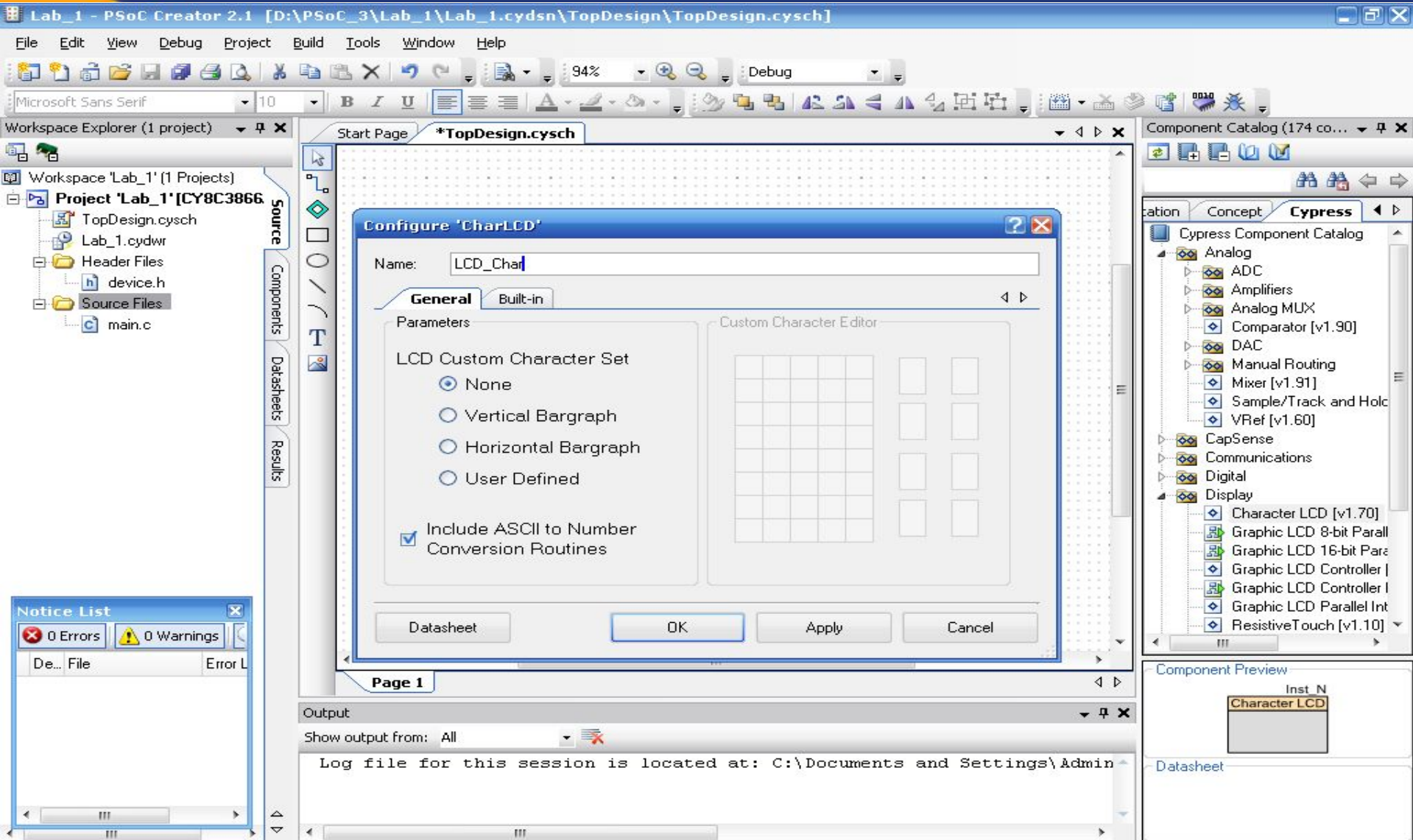

Lab_1 - PSoC Creator 2.1 [D:\PSoc_3\Lab_1\Lab_1.cydsn\TopDesign\TopDesign.cysch]

File Edit View Debug Project Build Tools Window Help

Microsoft Sans Serif 10 B I U

Workspace Explorer (1 project)

Project 'Lab_1' (1 Projects)

- Project 'Lab_1' [CY8C3866]
 - TopDesign.cysch
 - Lab_1.cydwr
 - Header Files
 - device.h
 - Source Files
 - main.c

Start Page *TopDesign.cysch

Component Catalog (174 co...)

Character LCD [v1.70]

Graphic LCD 8-bit Paralle...

Graphic LCD 16-bit Paralle...

Graphic LCD Controller I...

Graphic LCD Controller I...

Graphic LCD Parallel Int...

Resistive Touch [v1.10]

Configure 'CharLCD'

Name: LCD_Char

General Built-in

Parameters Custom Character Editor

LCD Custom Character Set

- None
- Vertical Bargraph
- Horizontal Bargraph
- User Defined

Include ASCII to Number Conversion Routines

Datasheet OK Apply Cancel

Notice List

0 Errors 0 Warnings

De... File Error L

Output

Show output from: All

Log file for this session is located at: C:\Documents and Settings\Admin

Page 1

Component Preview

Inst N

Character LCD

Datasheet

Ready {X=295,Y=131} 0 Errors 0 Warnings 0 Notes

Новости Украины | ... Do_Present_1.doc - ... PSoC Creator 2.1 EN 19:25

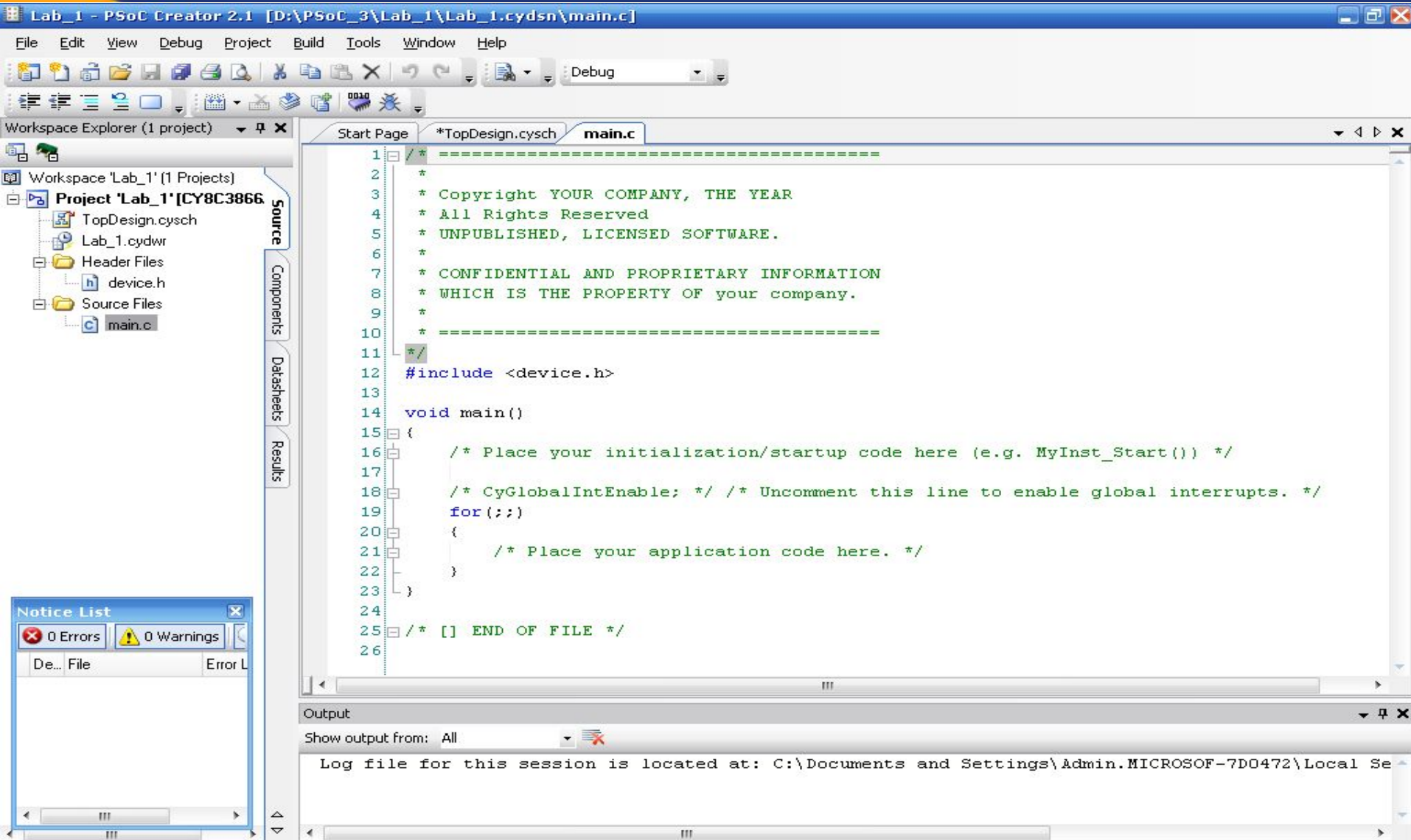

The screenshot displays the PSoC Creator 2.1 IDE interface. The main window shows the source code for `main.c` with the following content:

```
1  /* -----  
2  *  
3  * Copyright YOUR COMPANY, THE YEAR  
4  * All Rights Reserved  
5  * UNPUBLISHED, LICENSED SOFTWARE.  
6  *  
7  * CONFIDENTIAL AND PROPRIETARY INFORMATION  
8  * WHICH IS THE PROPERTY OF your company.  
9  *  
10 * -----  
11 */  
12 #include <device.h>  
13  
14 void main()  
15 {  
16     /* Place your initialization/startup code here (e.g. MyInst_Start()) */  
17  
18     /* CyGlobalIntEnable; */ /* Uncomment this line to enable global interrupts. */  
19     for (;;)   
20     {  
21         /* Place your application code here. */  
22     }  
23 }  
24  
25 /* [] END OF FILE */  
26
```

The Workspace Explorer on the left shows the project structure for 'Project 'Lab_1'[CY8C3866]', including files like `TopDesign.cysch`, `Lab_1.cydwr`, `device.h`, and `main.c`. A 'Notice List' window is open in the bottom-left corner, showing '0 Errors' and '0 Warnings'. The Output window at the bottom displays the message: 'Log file for this session is located at: C:\Documents and Settings\Admin.MICROSOFT-7D0472\Local Se...'. The status bar at the bottom indicates 'Ln 1 Col 1 INS 0 Errors 0 Warnings 0 Notes'.

Lab_1 - PSoC Creator 2.1 [D:\PSoC_3\Lab_1\Lab_1.cydsn\Lab_1.cydw] 37% Debug

File Edit View Debug Project Build Tools Window Help

Workspace Explorer (1 project)

- Workspace 'Lab_1' (1 Projects)
 - Project 'Lab_1' [CY8C3866]
 - TopDesign.cysch
 - Lab_1.cydw
 - Header Files
 - device.h
 - Source Files
 - main.c

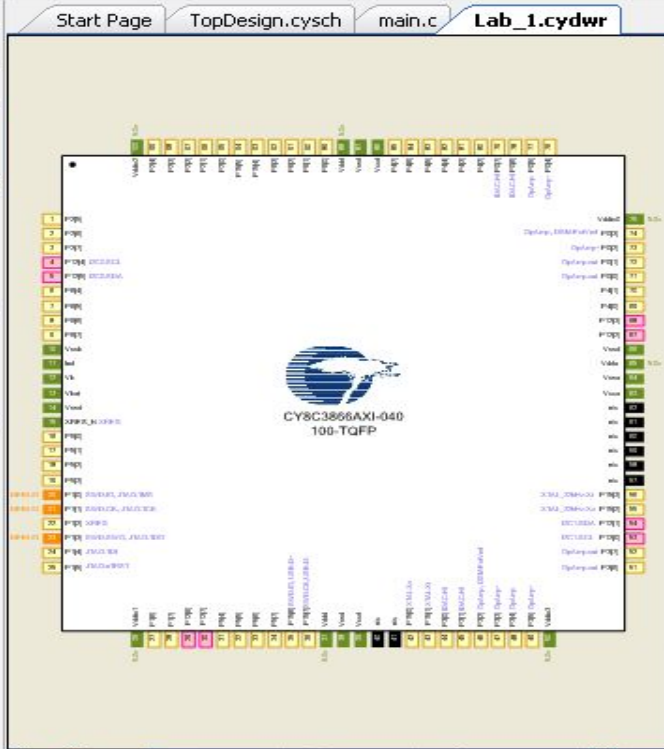

Alias	Name	Port	Pin	Lock
	\LCD_Char:LCDPort[6:0]\			
		P0[6:0]	IDAC:HC	
		P0[7:1]	IDAC:HC	
		P2[6:0]		
		P2[7:1]		
		P3[6:0]	OpAmp:c	
		P3[7:1]	OpAmp:c	
		P4[6:0]		
		P4[7:1]		
		P5[6:0]		

LCD_Char_LCDPort_6 - Digital
LCD_Char_LCDPort_5 - Digital
LCD_Char_LCDPort_4 - Digital

Notice List

0 Errors 0 Warnings

De... File Error L

Pins Analog Clocks Interrupts DMA System Directives Flash Security

Output

Show output from: All

Log file for this session is located at: C:\Documents and Settings\Admin.MICROSOFT-7D0472\Local Se

Lab_2 PWM

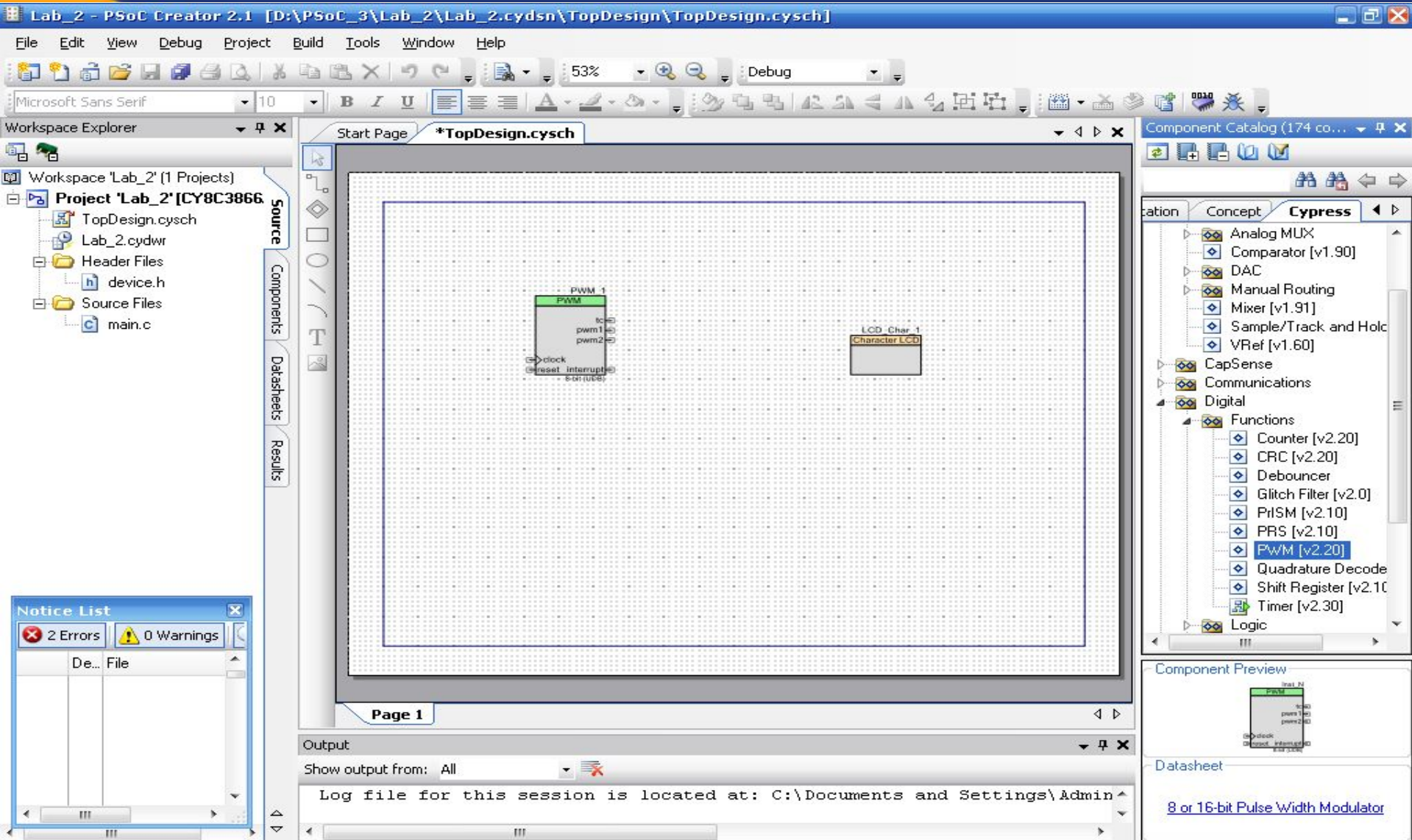

The screenshot displays the PSoC Creator 2.1 software interface. The main workspace shows a schematic diagram on a grid with two components: a PWM block and a Character LCD block. The PWM block has pins for 'clock', 'reset', 'interrupt', 'pwm1', and 'pwm2'. The Character LCD block is labeled 'LCD Char 1' and 'Character LCD'. The interface includes a menu bar (File, Edit, View, Debug, Project, Build, Tools, Window, Help), a toolbar, and a Component Catalog on the right. The Component Catalog is expanded to 'Digital' > 'Functions' > 'PWM [v2.20]'. A Notice List window in the bottom-left corner shows '2 Errors' and '0 Warnings'. The Output window at the bottom displays the message: 'Log file for this session is located at: C:\Documents and Settings\Admin...'. The status bar at the bottom right indicates '2 Errors 0 Warnings 0 Notes'.

Lab_2 - PSoC Creator 2.1 [D:\PSOC_3\Lab_2\Lab_2.cysdn\TopDesign\TopDesign.cysch]

File Edit View Debug Project Build Tools Window Help

Microsoft Sans Serif 10 B I U

Workspace Explorer

- Workspace 'Lab_2' (1 Projects)
 - Project 'Lab_2' [CY8C3866]
 - TopDesign.cysch
 - Lab_2.cydw
 - Header Files
 - device.h
 - Source Files
 - main.c

Start Page *TopDesign.cysch

Component Catalog (174 co...)

- Concept
 - Cypress
 - Analog MUX
 - Comparator [v1.90]
 - DAC
 - Manual Routing
 - Mixer [v1.91]
 - Sample/Track and Hold
 - VRef [v1.60]
 - CapSense
 - Communications
 - Digital
 - Functions
 - Counter [v2.20]
 - CRC [v2.20]
 - Debouncer
 - PrISM [v2.10]
 - PRS [v2.10]
 - PWM [v2.20]
 - Quadrature Decode
 - Shift Register [v2.10]
 - Timer [v2.30]
 - Logic

Notice List

2 Errors 0 Warnings

De... File

Page 1

Output

Show output from: All

Log file for this session is located at: C:\Documents and Settings\Admin

Component Preview

Datasheet

8 or 16-bit Pulse Width Modulator

Ready {X=45,Y=432} 2 Errors 0 Warnings 0 Notes EN 6:46

Lab_2 - PSoC Creator 2.1 [D:\PSoc_3\Lab_2\Lab_2.cydsn\TopDesign\TopDesign.cysch]

File Edit View Debug Project Build Tools Window Help

Microsoft Sans Serif 10 B I U

Workspace Explorer

- Workspace 'Lab_2' (1 Projects)
 - Project 'Lab_2' [CY8C3866]
 - TopDesign.cysch
 - Lab_2.cydwr
 - Header Files
 - device.h
 - Source Files
 - main.c

Start Page *TopDesign.cysch

Component Catalog (174 co...)

Configuration Concept Cypress

- Analog MUX
 - Comparator [v1.90]
 - DAC
 - Manual Routing
 - Mixer [v1.91]
 - Sample/Track and Hold
 - VRef [v1.60]
- CapSense
- Communications
- Digital
 - Functions
 - Counter [v2.20]
 - CRC [v2.20]
 - Debouncer
 - Glitch Filter [v2.0]
 - PrISM [v2.10]
 - PRS [v2.10]
 - PWM [v2.20]
 - Quadrature Decode
 - Shift Register [v2.10]
 - Timer [v2.30]
 - Logic

Component Preview

Datasheet

[8 or 16-bit Pulse Width Modulator](#)

Notice List

2 Errors 0 Warnings

De... File

Page 1

Output

Show output from: All

Log file for this session is located at: C:\Documents and Settings\Admin

Configure 'PWM'

Name: PWM

Configure Advanced Built-in

period 255 0 255 0

pwm1

pwm2

Implementation: Fixed Function UDB

Resolution: 8-Bit 16-Bit

PWM Mode: Two Outputs

Period: 255 Max *Period = UNKNOWN SOURCE FREQ*

CMP Value 1: 127 CMP Value 2: 63

Datasheet OK Apply Cancel

Ready

2 Errors 0 Warnings 0 Notes

EN 6:53

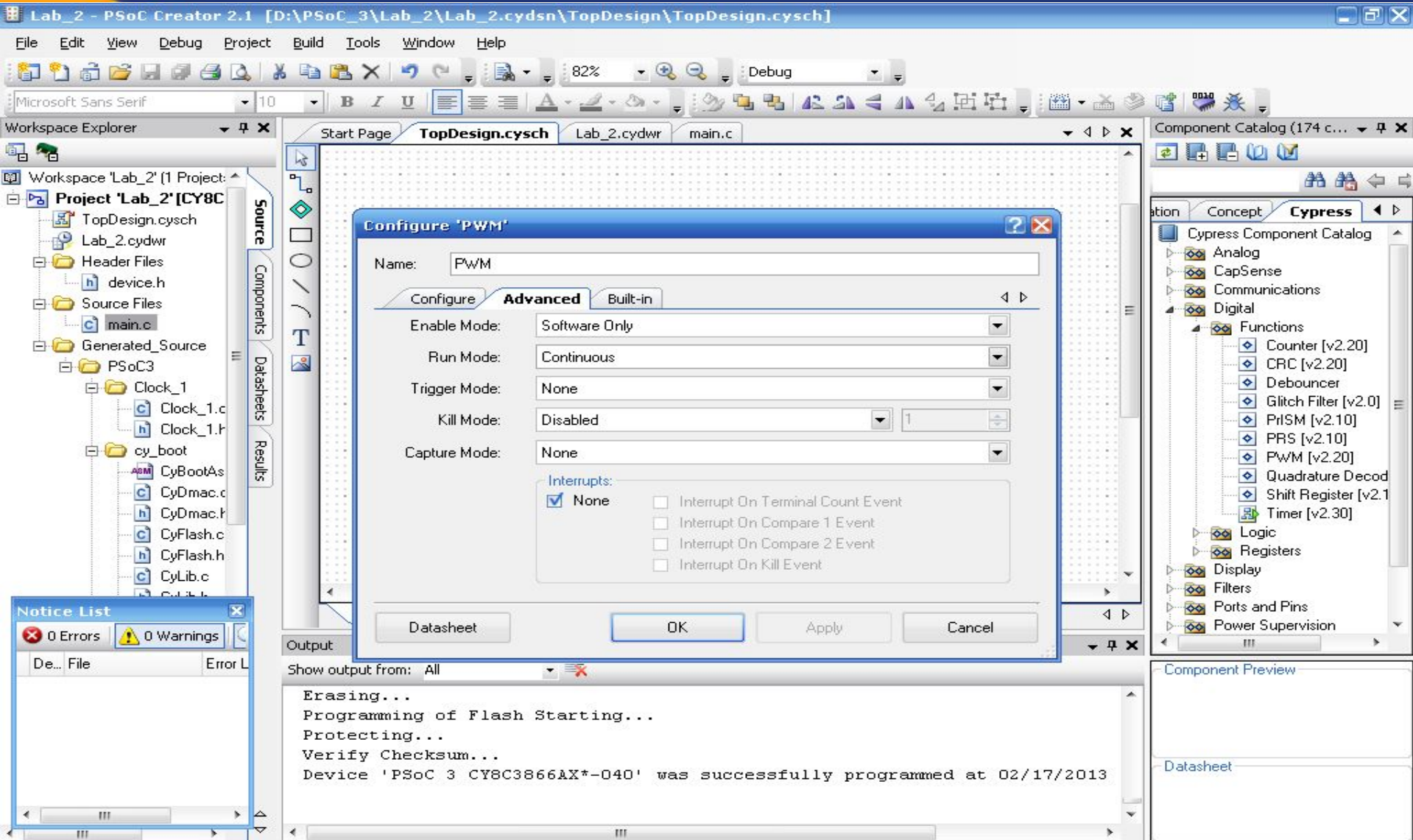

The screenshot displays the PSoC Creator 2.1 interface. The main window shows the 'Configure PWM' dialog box with the following settings:

- Name: PWM
- Configure: Advanced
- Enable Mode: Software Only
- Run Mode: Continuous
- Trigger Mode: None
- Kill Mode: Disabled
- Capture Mode: None
- Interrupts: None, Interrupt On Terminal Count Event, Interrupt On Compare 1 Event, Interrupt On Compare 2 Event, Interrupt On Kill Event

The 'Notice List' window shows 0 Errors and 0 Warnings. The 'Output' window displays the following text:

```
Erasing...  
Programming of Flash Starting...  
Protecting...  
Verify Checksum...  
Device 'PSoC 3 CY8C3866AX*-040' was successfully programmed at 02/17/2013
```

Lab_2 PWM

Lab_2 - PSoC Creator 2.1 [D:\PSoC_3\Lab_2\Lab_2.cydsn\TopDesign\TopDesign.cysch]

File Edit View Debug Project Build Tools Window Help

82% Debug

Microsoft Sans Serif 10

Workspace Explorer

Project 'Lab_2' (1 Projects)

- Project 'Lab_2' [CY8C381]
 - TopDesign.cysch
 - Lab_2.cydw
 - Header Files
 - device.h
 - Source Files
 - main.c

Source Components Datasheets Results

Start Page *TopDesign.cysch Lab_2.cydw

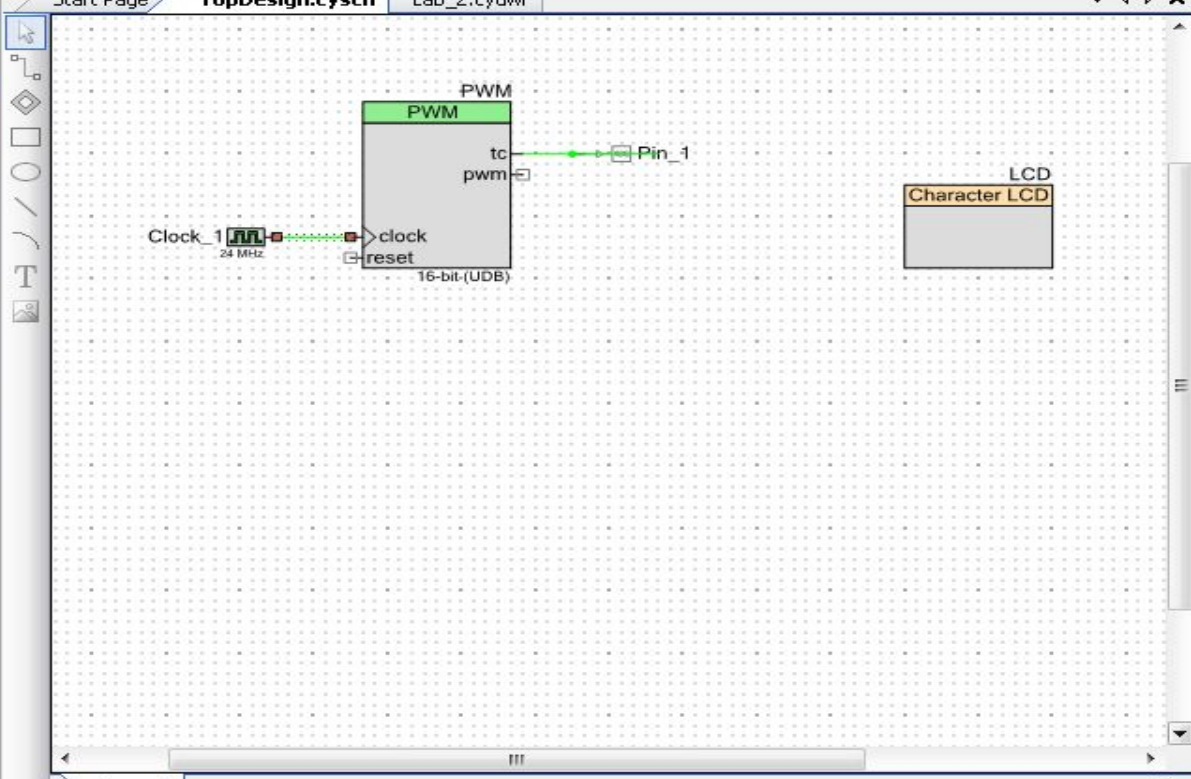

Component Catalog (17...)

- Concept Cypress
 - Ports and Pins
 - Analog Pin [v1.70]
 - Digital Bidirectional
 - Digital Input Pin [v1
 - Digital Output Pin [v
 - Power Supervision
 - System
 - Boost Converter [v
 - Bootloadable
 - Bootloader
 - Clock [v1.70]
 - Die Temperature [v
 - DMA [v1.60]
 - EEPROM [v2.0]
 - External Memory In
 - Global Signal Refer
 - Interrupt [v1.60]
 - RTC [v1.70]
 - SleepTimer [v3.10]
 - Sync
 - UDBCkEn
 - Thermal Management

Component Preview

Inst_N  24 MHz

Datasheet

[A specification of a required clock - source, frequency and tolerance.](#)

Page 1

Output

Show output from: All

Log file for this session is located at: C:\Documents and Settings\Admin.MIC

Notice List

0 Errors 0 Warnings

De... File Error L

Ready

0 Errors 0 Warnings 0 Notes

Lab_2 - PSoC Creator... Do_Present_2.doc - ...

EN 17:52

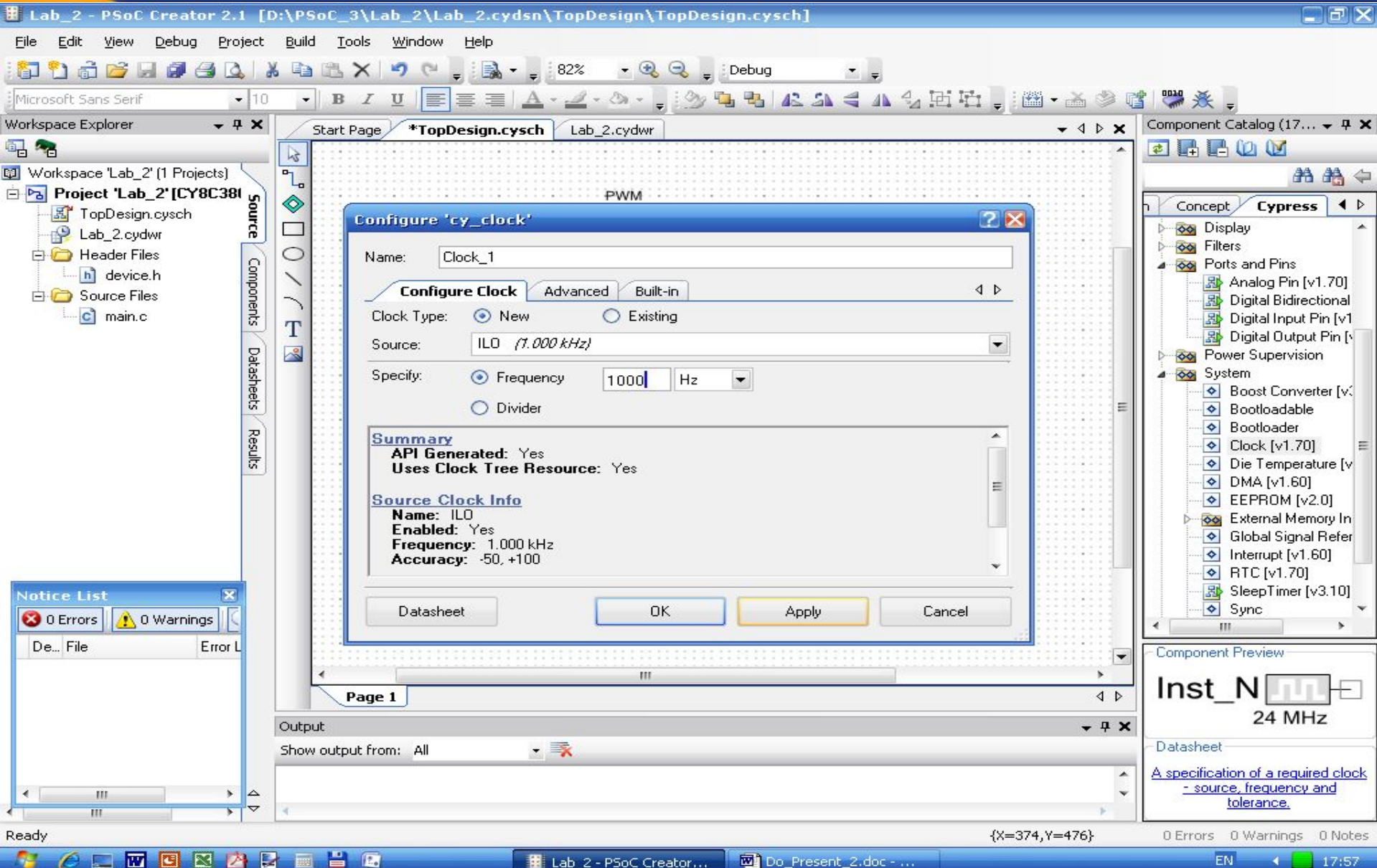

The screenshot displays the PSoC Creator 2.1 software interface. The main workspace shows a PWM component being configured. A dialog box titled "Configure 'cy_clock'" is open, showing the following settings:

- Name: Clock_1
- Configure Clock (selected), Advanced, Built-in
- Clock Type: New, Existing
- Source: ILO (1.000 kHz)
- Specify: Frequency, 1000 Hz, Divider

The Summary section indicates:

- API Generated: Yes
- Uses Clock Tree Resource: Yes

The Source Clock Info section shows:

- Name: ILO
- Enabled: Yes
- Frequency: 1.000 kHz
- Accuracy: -50, +100

Buttons at the bottom of the dialog include Datasheet, OK, Apply, and Cancel. The Component Catalog on the right shows various components like Display, Filters, Ports and Pins, Power Supervision, and System. The Component Preview at the bottom right shows "Inst_N" with a 24 MHz clock signal.



Lab_2 PWM

Do_Present_2.doc - Microsoft Word

Файл Правка Вид Вставка Формат Сервис Таблица Окно Справка

Исправления в измененном документе Показывать

143%

12

Lab_2 - PSoC Creator 2.1 [D:\PSoC_3\Lab_2\Lab_2.cysdn\TopDesign\TopDesign.cysch]

File Edit View Debug Project Build Tools Window Help

82% Debug

Microsoft Sans Serif 10

Workspace Explorer

Workspace 'Lab_2' (1 Projects)

- Project 'Lab_2' [CY8C381]
- TopDesign.cysch
- Lab_2.cydwr
- Header Files
- device.h
- Source Files
- main.c

Source Components Datasheets Results

Start Page *TopDesign.cysch Lab_2.cydwr

Component Catalog (17...)

- Concept Cypress
- Cypress Component Catalog
 - Analog
 - CapSense
 - Communications
 - Digital
 - Functions
 - Logic
 - Registers
 - Display
 - Filters
 - Ports and Pins
 - Analog Pin [v1.70]
 - Digital Bidirectional Pin [v1.70]
 - Digital Input Pin [v1.70]
 - Digital Output Pin [v1.70]
 - Power Supervision
 - System
 - Thermal Management

Notice List

3 Errors 0 Warnings

De... File

Действия Автофикуры

Стр. 7 Разд 1 7/13 На 2см Ст 1 Кол 1 ЗАП ИСПР ВДЛ ЗАМ английский

Lab_2 - PSoC Creator... Do_Present_2.doc - ... Microsoft PowerPoint ... EN 18:36

Lab_2 - PSoC Creator 2.1 [D:\PSoc_3\Lab_2\Lab_2.cydsn\TopDesign\TopDesign.cysch]

File Edit View Debug Project Build Tools Window Help

Microsoft Sans Serif 10 B I U

Workspace Explorer

- Workspace 'Lab_2' (1 Projects)
 - Project 'Lab_2' [CY8C381]
 - TopDesign.cysch
 - Lab_2.cydwr
 - Header Files
 - device.h
 - Source Files
 - main.c

Start Page *TopDesign.cysch Lab_2.cydwr

PWM

Configure 'cy_pins'

Name: Pin_1

Pins Mapping Reset Built-in

Number of Pins: 1

[All Pins]

- Pin_1_0

Type General Input Output

- Analog
- Digital Input
- HW Connection
- Digital Output
- HW Connection
- Output Enable
- Bidirectional
- Show Annotation Terminal

Preview:

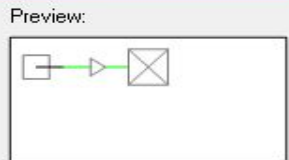

Datasheet OK Apply Cancel

Page 1

Output

Show output from: All

Log file for this session is located at: C:\Documents and Settings\Admin.MIC

Notice List

3 Errors 0 Warnings

De... File

Component Catalog (17...)

- Concept Cypress
 - Cypress Component Catalog
 - Analog
 - CapSense
 - Communications
 - Digital
 - Functions
 - Logic
 - Registers
 - Display
 - Filters
 - Ports and Pins
 - Analog Pin [v1.70]
 - Digital Bidirectional Pin [v1.70]
 - Digital Input Pin [v1.70]
 - Digital Output Pin [v1.70]
 - Power Supervision
 - System
 - Thermal Management

Component Preview



Pin_1

Datasheet

[Pins component configured for digital output.](#)

Ready {X=369,Y=311} 3 Errors 0 Warnings 0 Notes

Lab_2 - PSoC Creator... Do_Present_2.doc - ...

EN 17:36

Lab_2 - PSoC Creator 2.1 [D:\PSoc_3\Lab_2\Lab_2.cydsn\TopDesign\TopDesign.cysch]

File Edit View Debug Project Build Tools Window Help

Microsoft Sans Serif 10 B I U

Workspace Explorer

- Workspace 'Lab_2' (1 Projects)
 - Project 'Lab_2' [CY8C381]
 - TopDesign.cysch
 - Lab_2.cydwr
 - Header Files
 - device.h
 - Source Files
 - main.c

Start Page *TopDesign.cysch Lab_2.cydwr

PWM

Configure 'cy_pins'

Name: Pin_1

Pins Mapping Reset Built-in

Number of Pins: 1

[All Pins]

- Pin_1_0

Type General Input Output

Drive Mode: Strong Drive

Initial State: Low (0)

Minimum Supply Voltage:

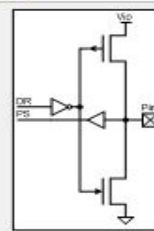

Datasheet OK Apply Cancel

Component Catalog (17...)

- Concept Cypress
 - Cypress Component Catalog
 - Analog
 - CapSense
 - Communications
 - Digital
 - Functions
 - Logic
 - Registers
 - Display
 - Filters
 - Ports and Pins
 - Analog Pin [v1.70]
 - Digital Bidirectional Pin [v1.70]
 - Digital Input Pin [v1.70]
 - Digital Output Pin [v1.70]
 - Power Supervision
 - System
 - Thermal Management

Component Preview

Pin_1

Datasheet

[Pins component configured for digital output.](#)

Notice List

3 Errors 0 Warnings

De... File

Page 1

Output

Show output from: All

Log file for this session is located at: C:\Documents and Settings\Admin.MIC

Ready {X=312,Y=262} 3 Errors 0 Warnings 0 Notes EN 17:37

Lab_2 - PSoC Creator... Do_Present_2.doc - ...

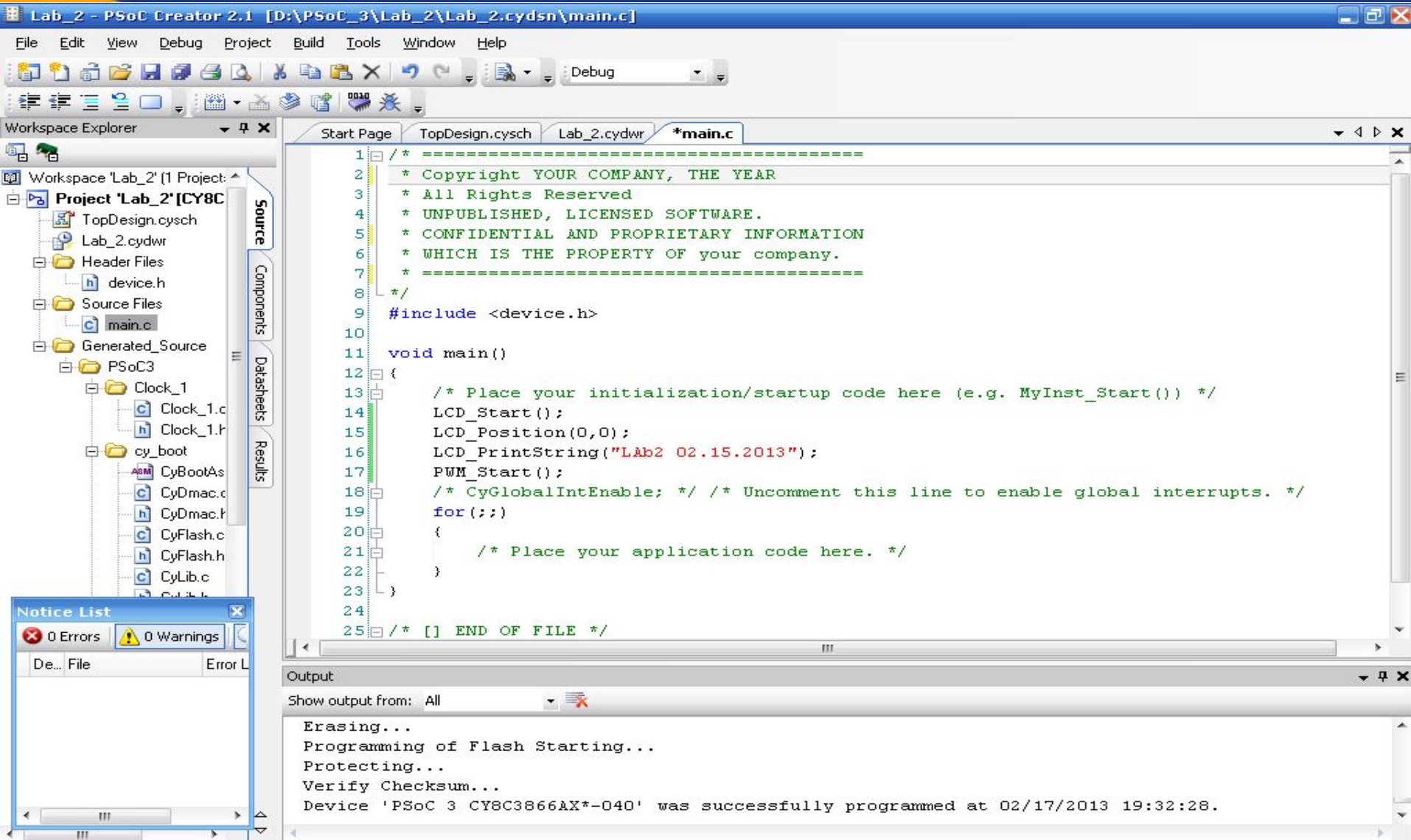

Lab_2 - PSoC Creator 2.1 [D:\PSOC_3\Lab_2\Lab_2.cydsn\main.c]

File Edit View Debug Project Build Tools Window Help

Debug

Workspace Explorer

- Workspace 'Lab_2' (1 Project)
- Project 'Lab_2' [CY8C
 - TopDesign.cysch
 - Lab_2.cydwr
 - Header Files
 - device.h
 - Source Files
 - main.c
 - Generated_Source
 - PSOC3
 - Clock_1
 - Clock_1.c
 - Clock_1.h
 - cy_boot
 - CyBootAs
 - CyDmac.c
 - CyDmac.h
 - CyFlash.c
 - CyFlash.h
 - CyLib.c
 - CyLib.h

Source Components Datasheets Results

```
1  /* =====
2  * Copyright YOUR COMPANY, THE YEAR
3  * All Rights Reserved
4  * UNPUBLISHED, LICENSED SOFTWARE.
5  * CONFIDENTIAL AND PROPRIETARY INFORMATION
6  * WHICH IS THE PROPERTY OF your company.
7  * =====
8  */
9  #include <device.h>
10
11 void main()
12 {
13     /* Place your initialization/startup code here (e.g. MyInst_Start()) */
14     LCD_Start();
15     LCD_Position(0,0);
16     LCD_PrintString("LAB2 02.15.2013");
17     PWM_Start();
18     /* CyGlobalIntEnable; */ /* Uncomment this line to enable global interrupts. */
19     for(;;)
20     {
21         /* Place your application code here. */
22     }
23 }
24
25 /* [] END OF FILE */
```

Notice List

0 Errors 0 Warnings

De... File Error L

Output

Show output from: All

```
Erasing...
Programming of Flash Starting...
Protecting...
Verify Checksum...
Device 'PSoC 3 CY8C3866AX*-040' was successfully programmed at 02/17/2013 19:32:28.
```

Ready

Ln 2 Col 1 INS 0 Errors 0 Warnings 0 Notes

Lab_2 - PSoC ... Do_Present_2... Microsoft Pow... Adobe Acrobat... EN 20:01

На сайті фірми Cypress знаходиться більше 200 Application Notes і Reference Designs, які ілюструють області застосування мікроконтролерів PSoC.

Design Support - Microsoft Internet Explorer

Address: http://www.cypress.com/portal/server.pt?space=CommunityPage&control=SetCommunity&Communi

Design Resources

Select one of the following materials to help you design-in Cypress products: Application Notes, Datasheets, Developer Kits, Errata Updates, Evaluation Boards, Models, Reference Designs, Software & Drivers and Technical Articles.

Select Product Group: -- All Product Groups --

Select Product Family: -- All Product Families --
 Application Specific Clocks
 Async SRAMs
 Automotive Products
 Backplane Interface & Clock Mgmt
 Bluetooth Solutions

Apply Filter

Application Notes	Datasheets	Developer Kits	Errata Update	Evaluation Boards
Models	More Resources	Reference Designs	Software and Drivers	Technical Articles

Technical Support

Product Family | **Descriptive Name** | **Date** | **Downloads**

Product Family	Descriptive Name	Date	Downloads
PSoC Mixed-Signal Array	AN2267a - Standard - Single Cell Li-Ion Battery Charger using CY8C21xxx	Apr 19, 2005	AN2267A.PDF AN2267A.ZIP
PSoC Mixed-Signal Array	AN2260 - Standard - Rapid NiCd/NiMH Battery Charger and DC Brushed Motor Controller for Autonomous Appliances	Apr 15, 2005	AN2260.PDF AN2260.ZIP
PSoC Mixed-Signal Array	AN2026b - Support - In-System Serial Programming Protocol CY8C24794 and CY8C29xxx	Apr 8, 2005	AN2026B.PDF
PSoC Mixed-Signal Array	AN2266 - Support - 16-Bit PWM/PWM-DACs using One Digital PSoC(TM) Block	Apr 8, 2005	AN2266.PDF AN2266.ZIP
PSoC Mixed-Signal Array	AN2279 - Support - Dynamic I2C Addressing Implemented with I2C Hardware User Modules	Apr 8, 2005	AN2279.PDF AN2279.ZIP
PSoC Mixed-Signal Array	AN2267 - Standard - Single Cell Li-Ion Battery Charger	Apr 1, 2005	AN2267.PDF AN2267.ZIP
PSoC Mixed-Signal Array	AN2222a - Support - Flex-Pod Soldering Guide	Mar 31, 2005	AN2222A.PDF
PSoC Mixed-Signal Array	AN2233a - Support - Capacitive Switch Scan	Mar 31, 2005	AN2233A.PDF
PSoC Mixed-Signal Array	AN2276 - Support - Binary Weighted Single-Pole IIR Low-Pass Filters	Mar 29, 2005	AN2276.PDF AN2276.ZIP
PSoC Mixed-Signal Array	AN2277 - Support - Capacitive Front Panel Display Demonstration	Mar 29, 2005	AN2277.PDF AN2277.ZIP

Found 201 items 1 - 10 | 11 - 20 | 21 - 30 | 31 - 40 | 41 - 50 | 51 - 60 | 61 - 70 | 71 - 80 | 81 - 90 | 91 - 100 | see 1 - 100 | next 100

Contact Us | Privacy | Terms & Conditions | How to Buy | 日本語 | 中文

© Copyright 1995-2005. Cypress Semiconductor Corporation. All rights reserved.

Мікропроцесорна техніка

(лекція 2, кінець)

Благітко Б.Я.

2019 р.

