

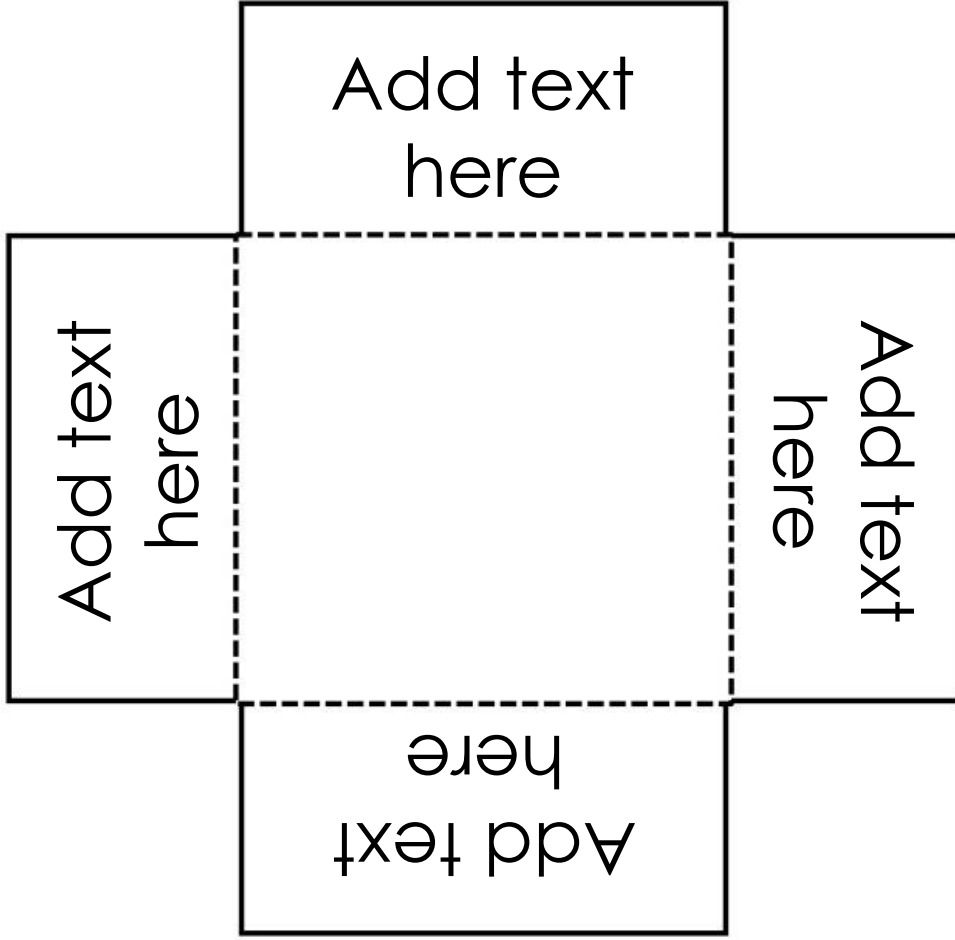

Lapbook Templates



4-Tab Rectangle



4-Tab Petal

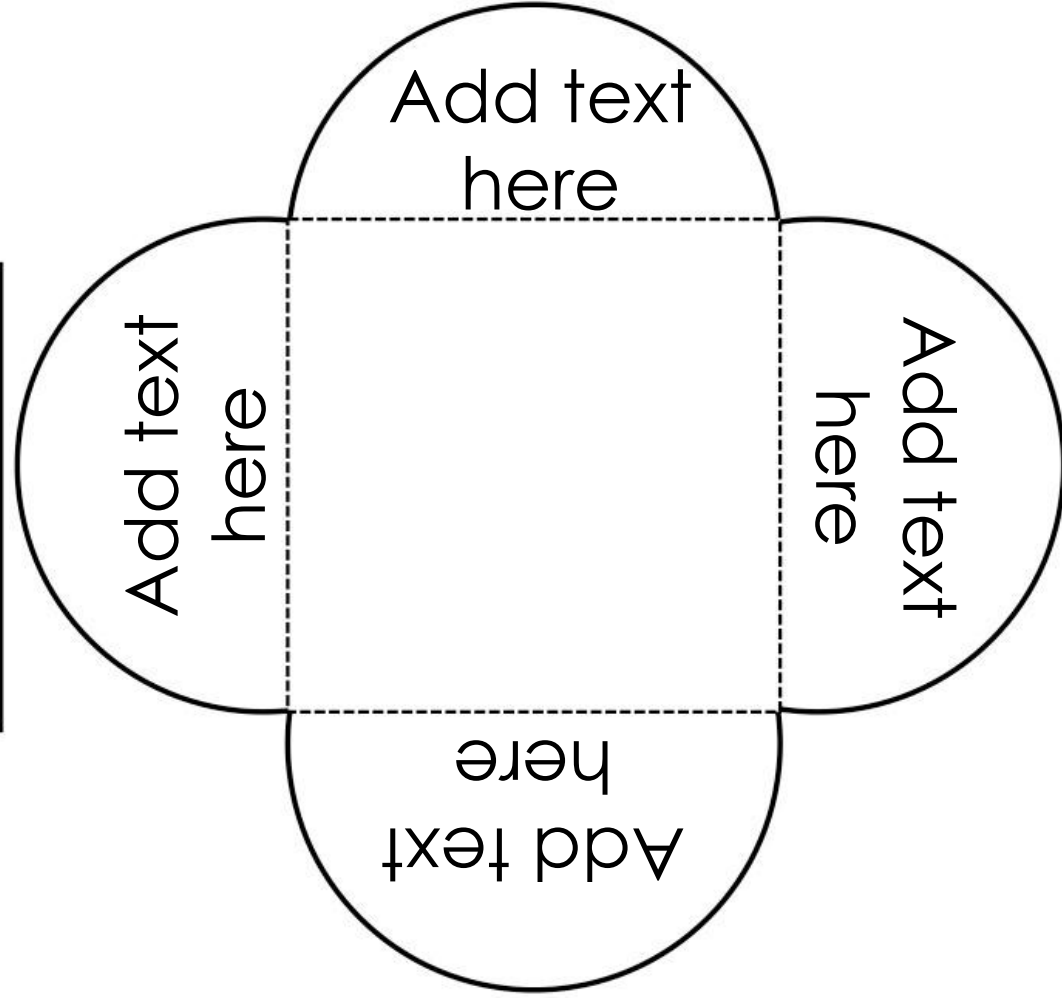

4-Tab Triangle

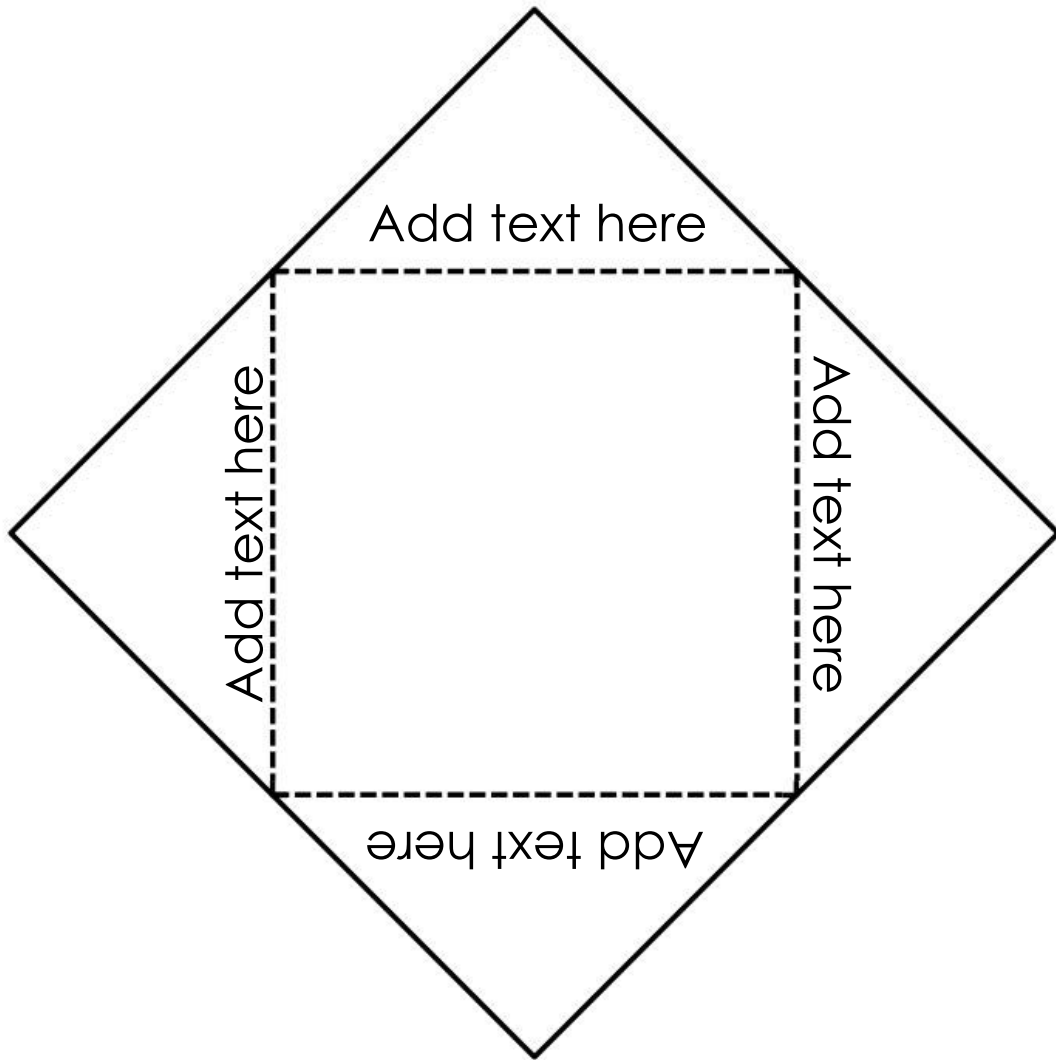

3-Tab

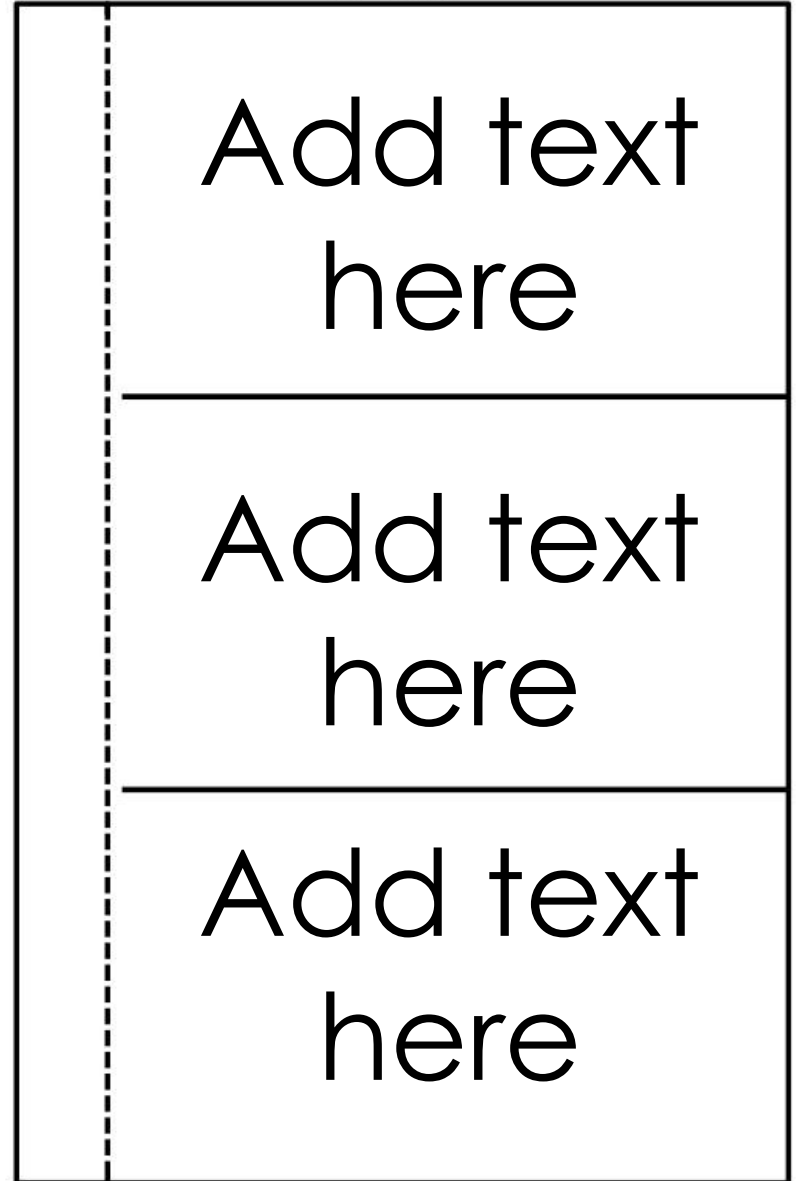

6-Tab Petal

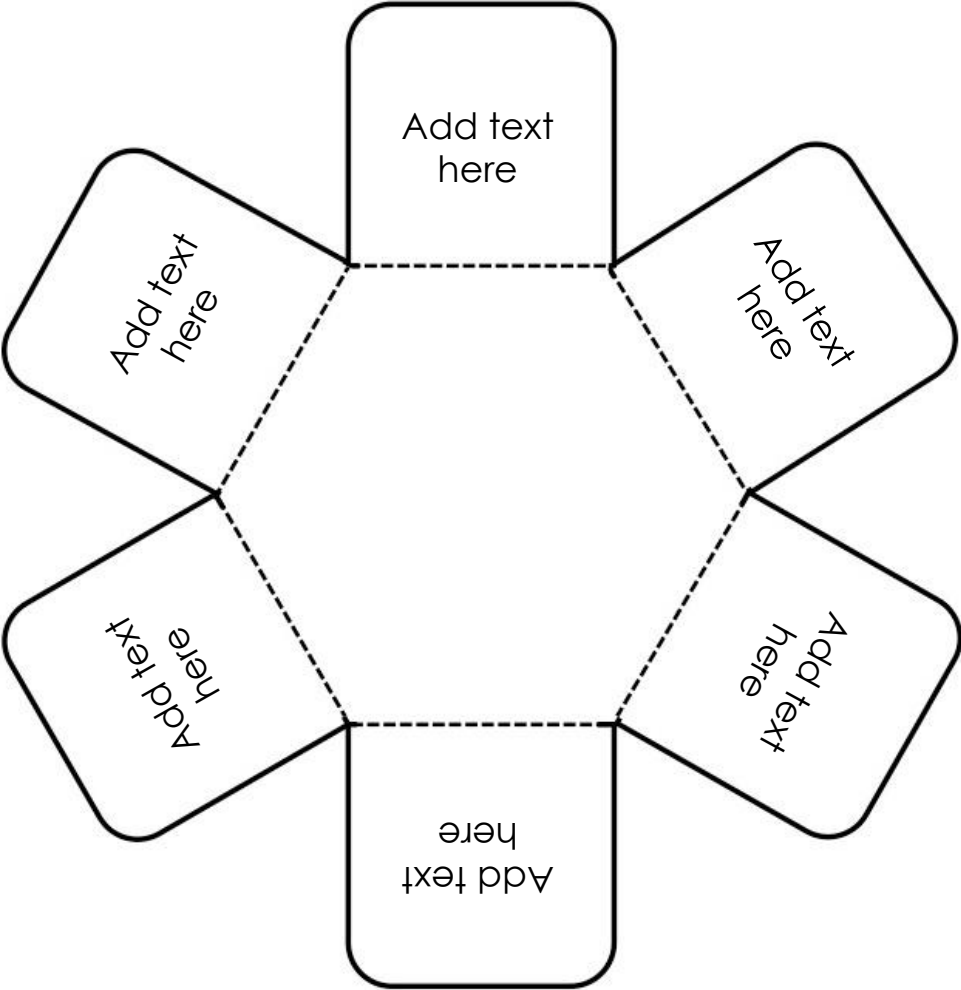

Ticket Accordion

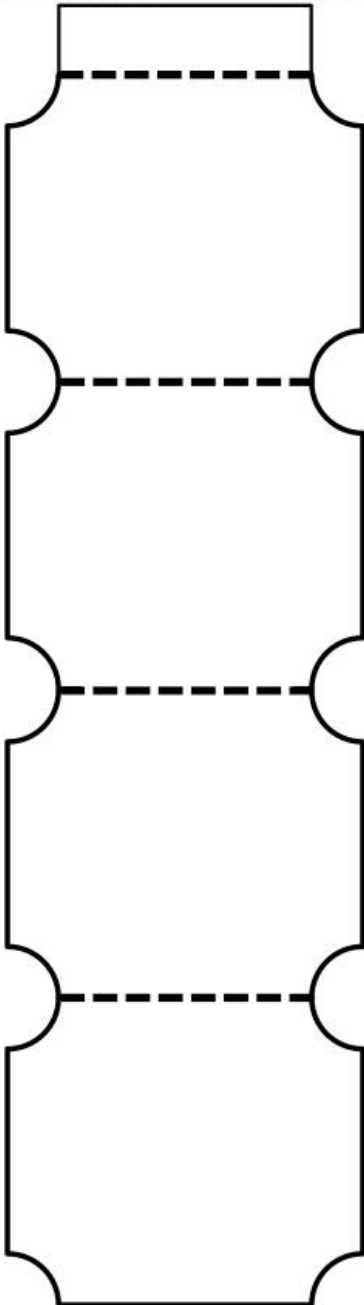

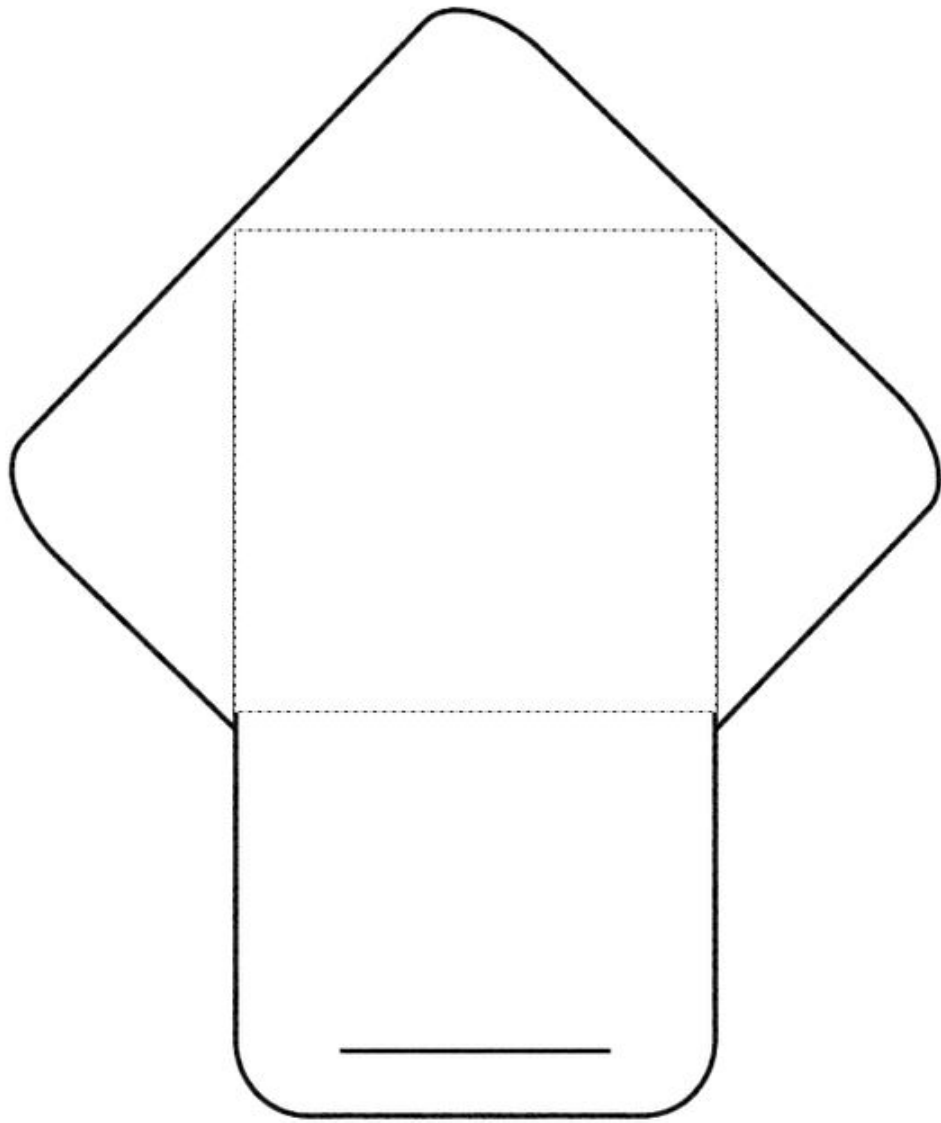

Cut out on outside line. Cut out thick slot. With lines facing down, fold up on each dotted line. Tuck corner into slot.

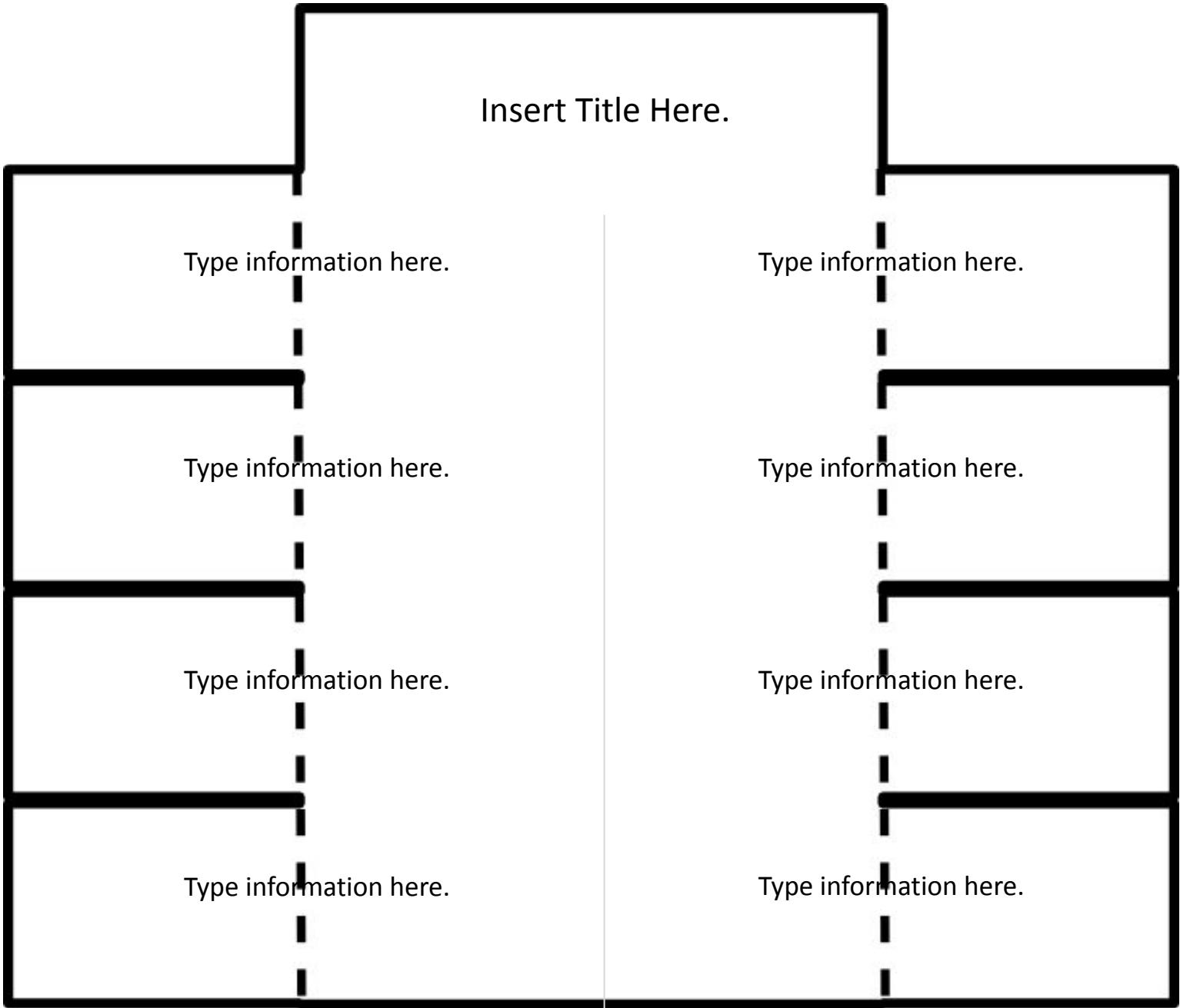

Insert Title Here.

Type information here.

Type information here.

Type information here.

Type information here.

Type information here.

Type information here.

Type information here.

Type information here.

**Assembly for the
Eight Shutterfolds
Book**

Cut the book out on the solid lines.

Fold the flaps inward on the dotted lines. Write subtitles on the outside of each of the eight flaps.

Assembly for the Tab Book

Cut out each page. Stack them on top of each other according to the page numbers. Staple on the left side on the two staple marks.

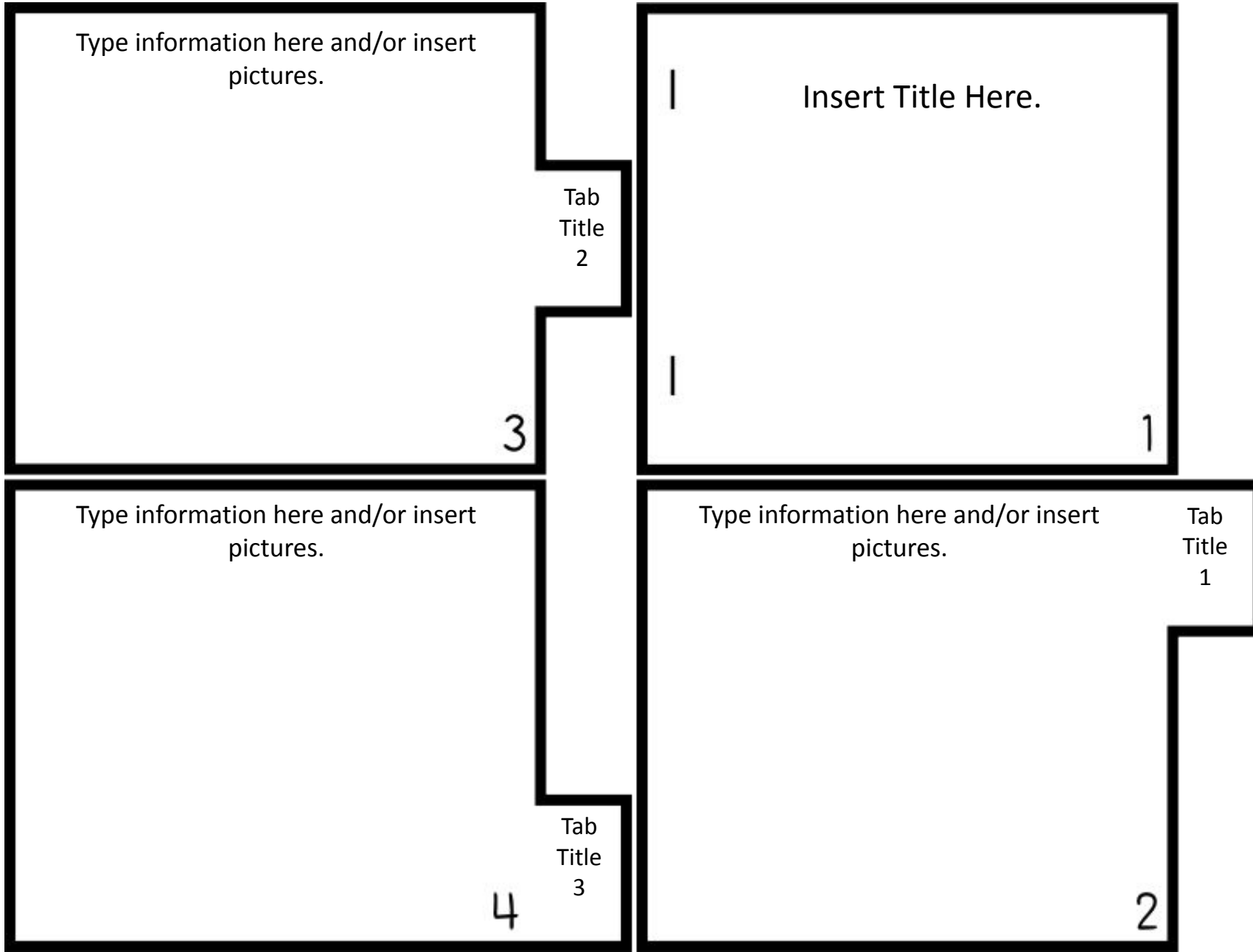

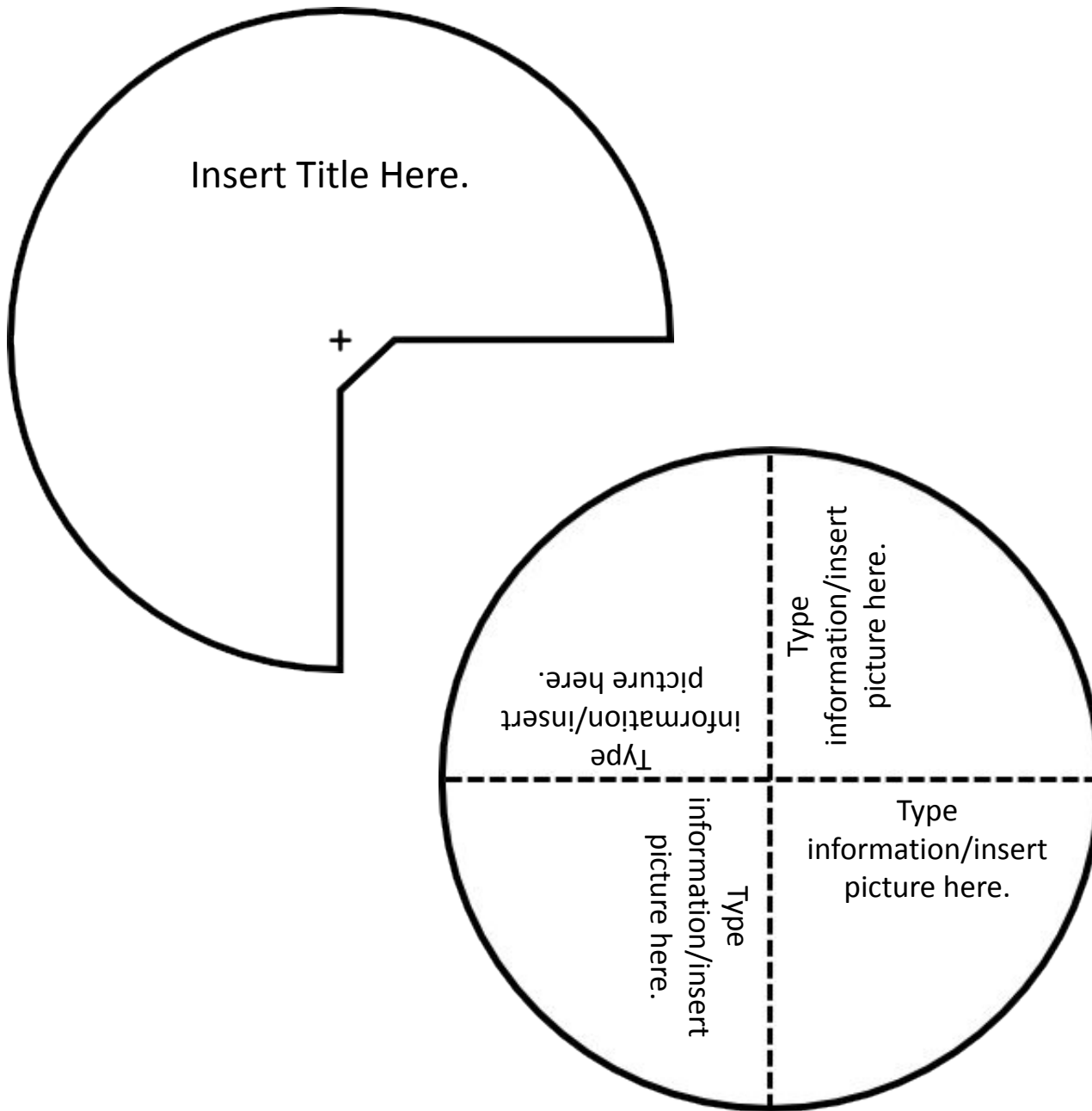

Assembly for the Wheel

Cut out both circles.
Place the title circle on top of the information circle. Use a tack to poke a hole through both of the circles on the plus sign. Stick a brad fastener through the hole and secure on the other end.

Type
information/insert
picture here.

**Assembly for the
Tongue-Fold Book**

Cut out the book
and the title piece
on the solid lines.

Fold the book in
half on the dotted
lines with the text
facing inwards.

Paste the title
piece on the front
of the book.

Insert title/images here. You will
cut this and paste it on the front.

Insert Title/Images here.

Assembly for Trifold Book

Cut the book and the title piece out on the solid lines. Fold the five flaps inward on the dotted lines. Then fold the left page on top of the flaps on the dotted lines. Paste the title piece on top of the front page.

Type information/insert picture here.

Type information/insert picture here.

Type information/insert picture here.

Type information/insert picture here.

Type information/insert picture here.

Type information/insert picture here.

Type information/insert picture here.

Insert Title Here.

Assembly for Simple Fold Book

Cut the book and the title piece out on the solid lines. Fold the book on the dotted lines. Paste the title piece on top of the front page.

Type information/insert picture here.

Type information/insert picture here.

Assembly for Circle Shutterfold Book

Cut the book on the solid lines. Fold the semicircles on the dotted lines with the text on the inside. Write a title on the front of each semicircle.

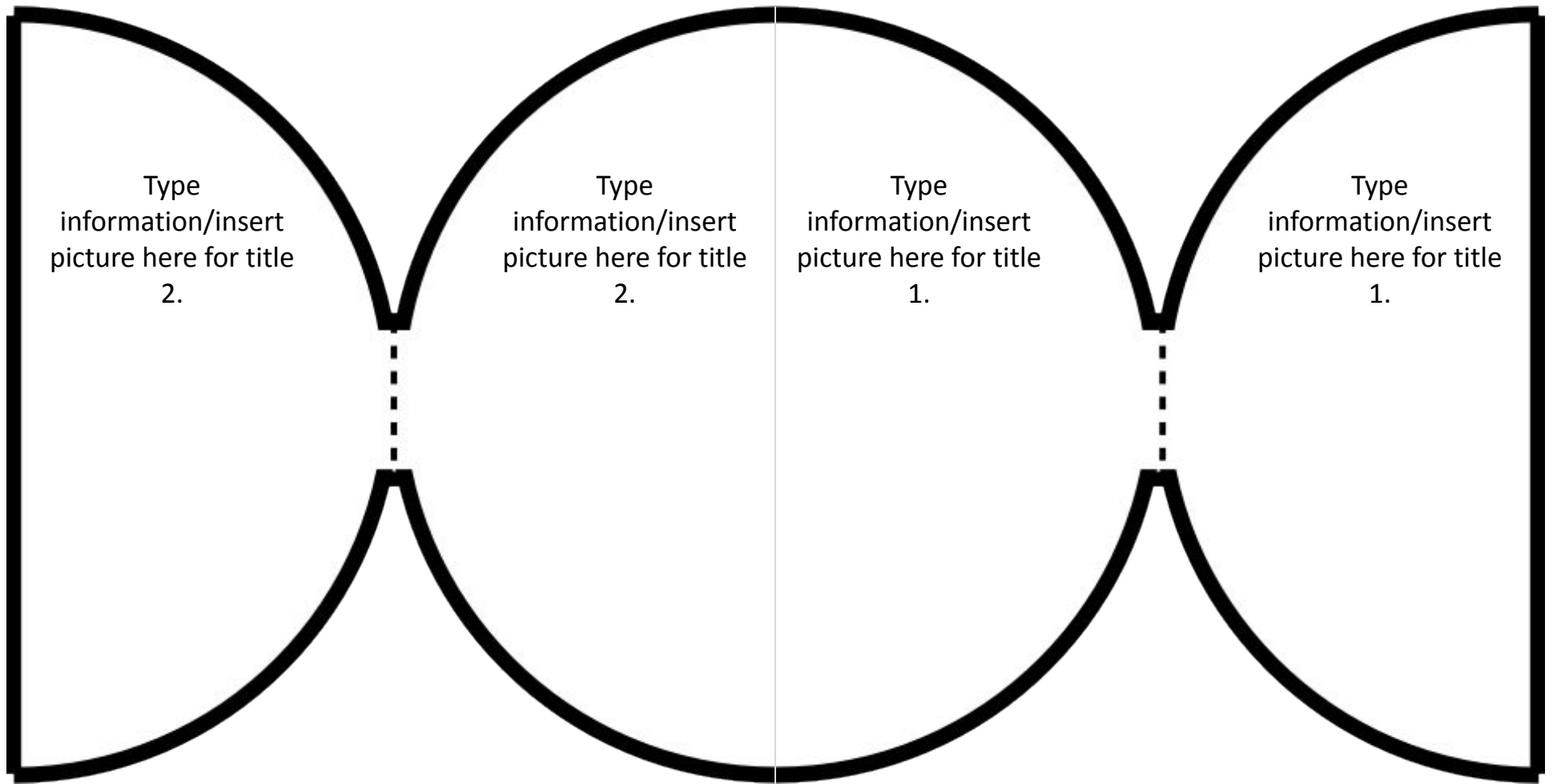

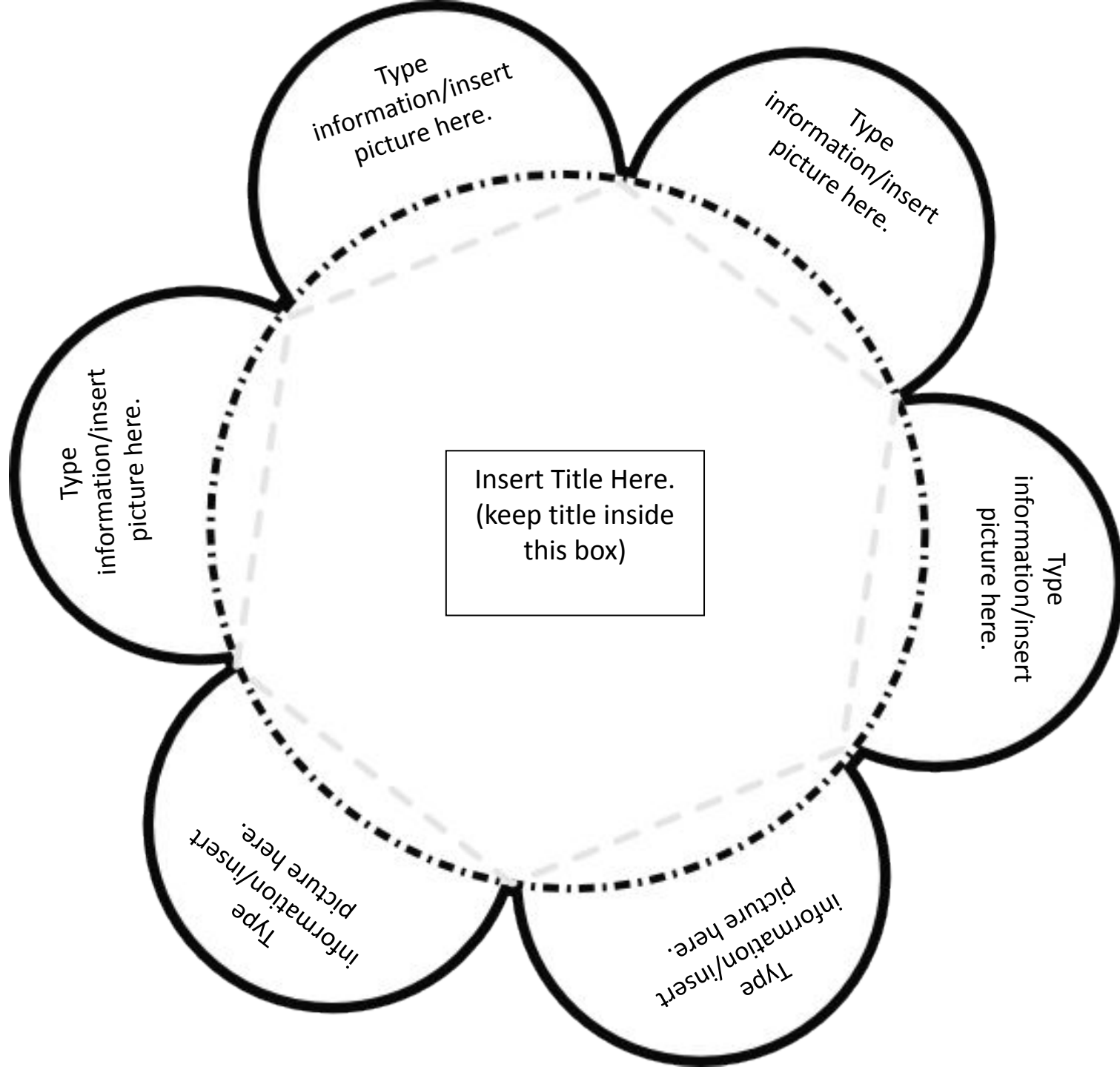

**Assembly for
the Flower Flap
Book**

Cut the flower out on the solid lines. Fold the petals down on the gray dotted lines with the text inside the flaps. Write subtitles on the top of each petal.

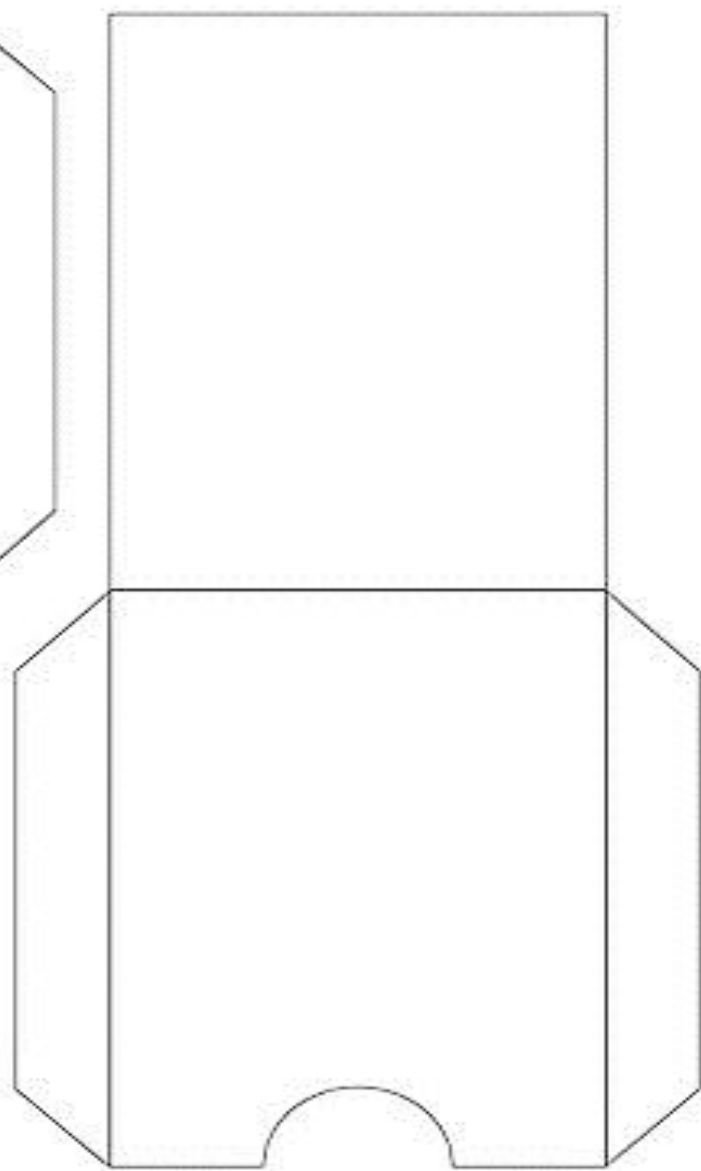
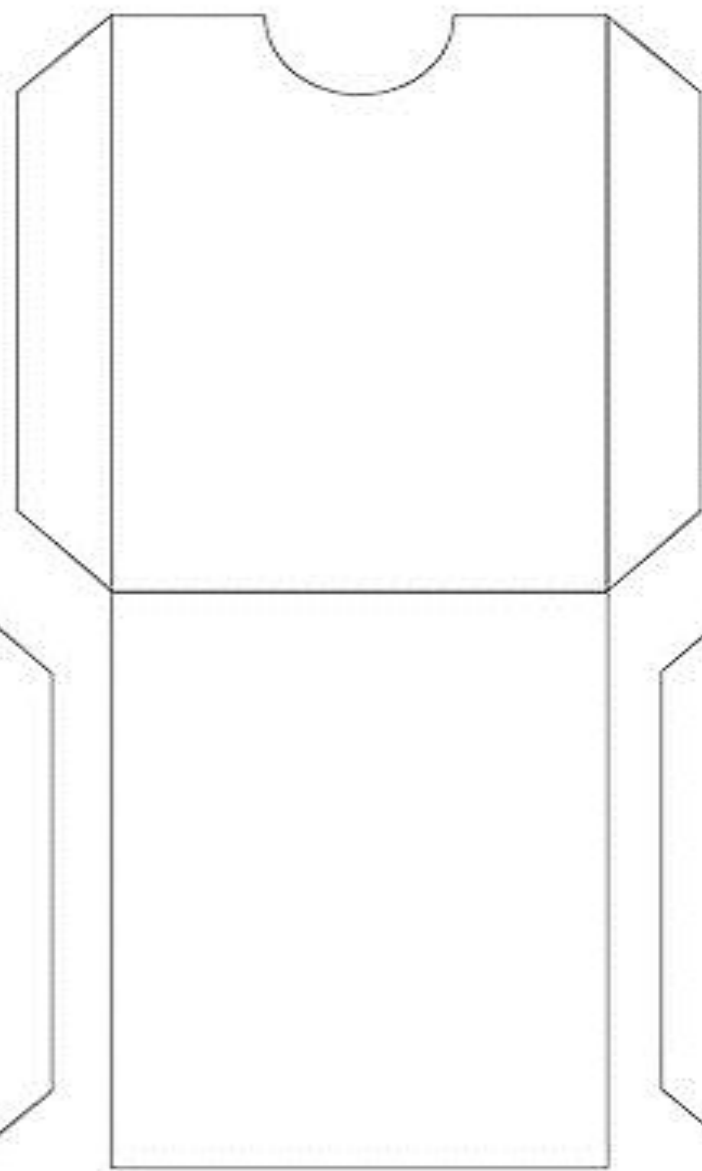
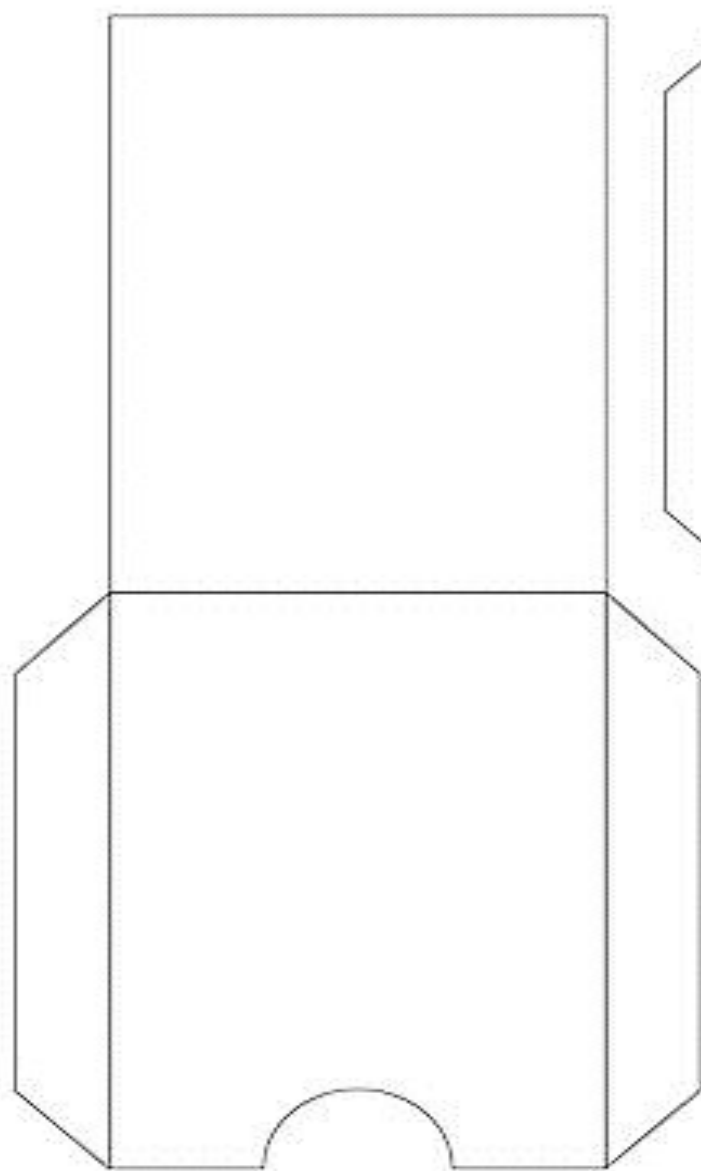

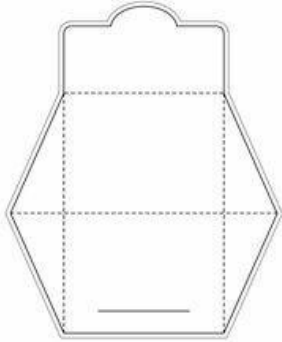
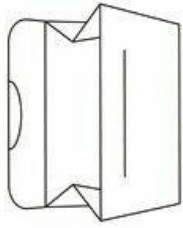
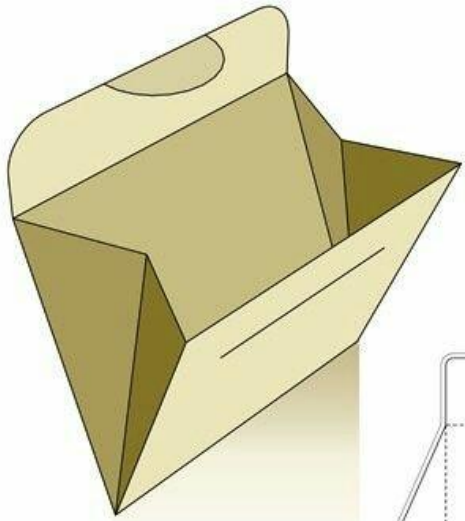

printing bleed
die-cutting line
folding line
perforation line
zipper line

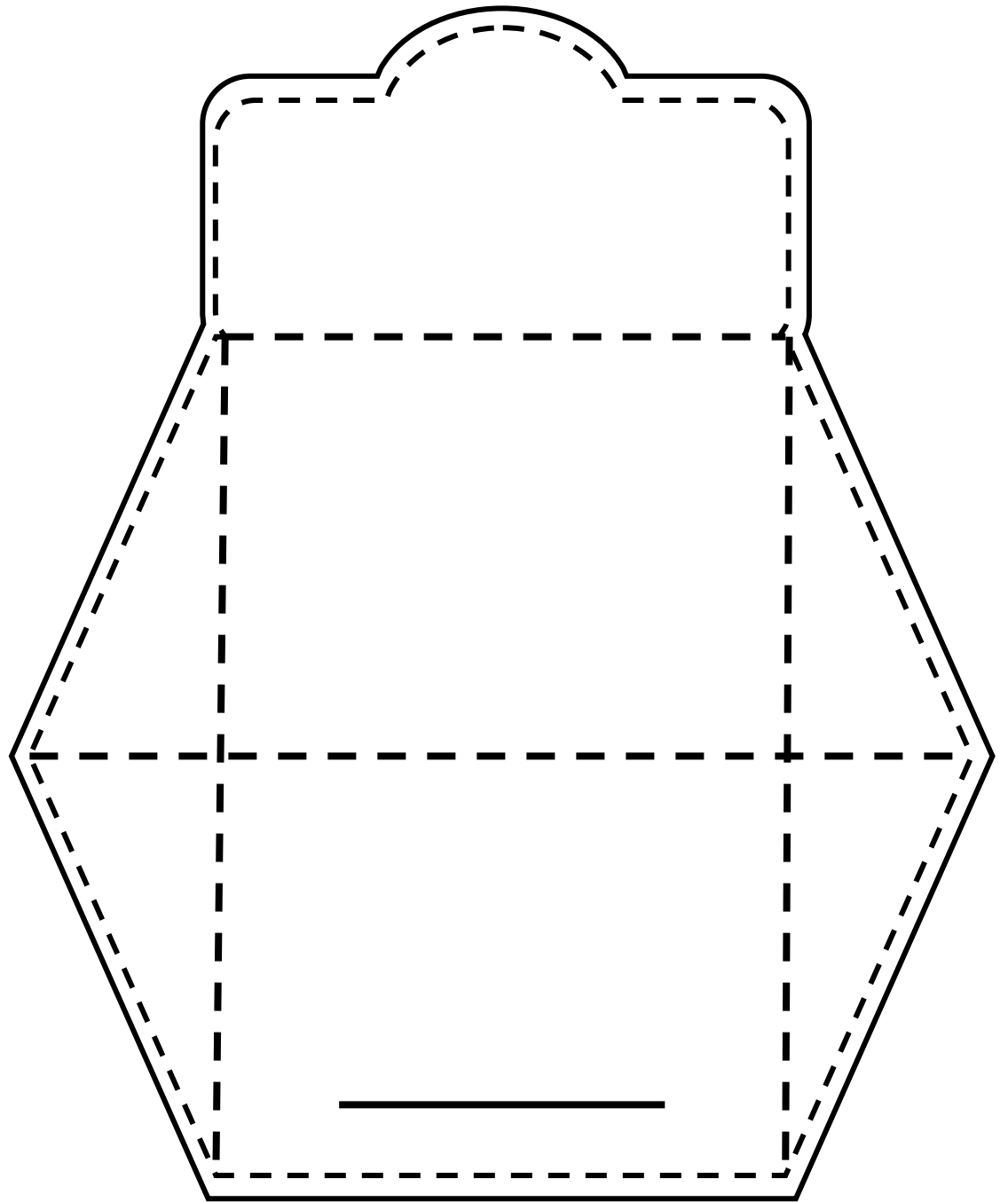

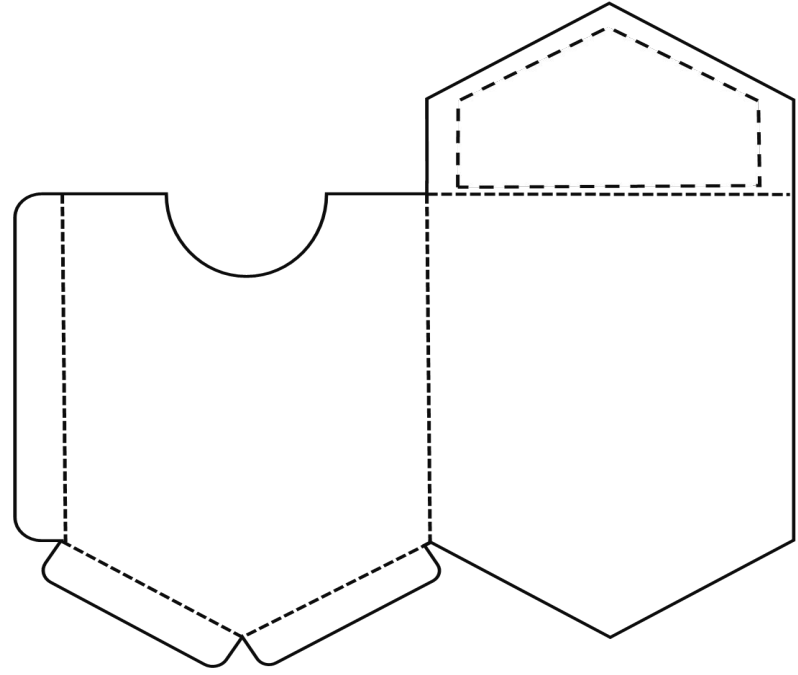
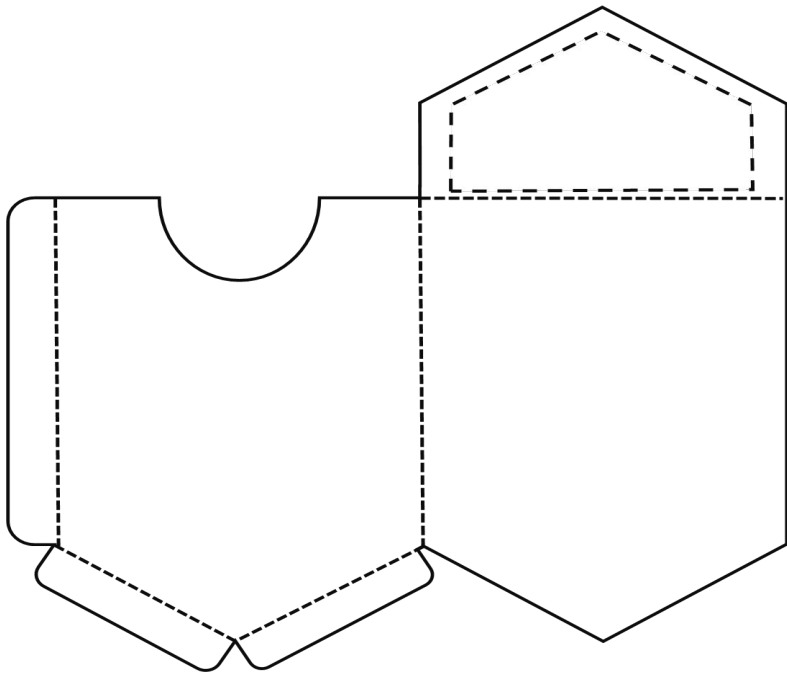
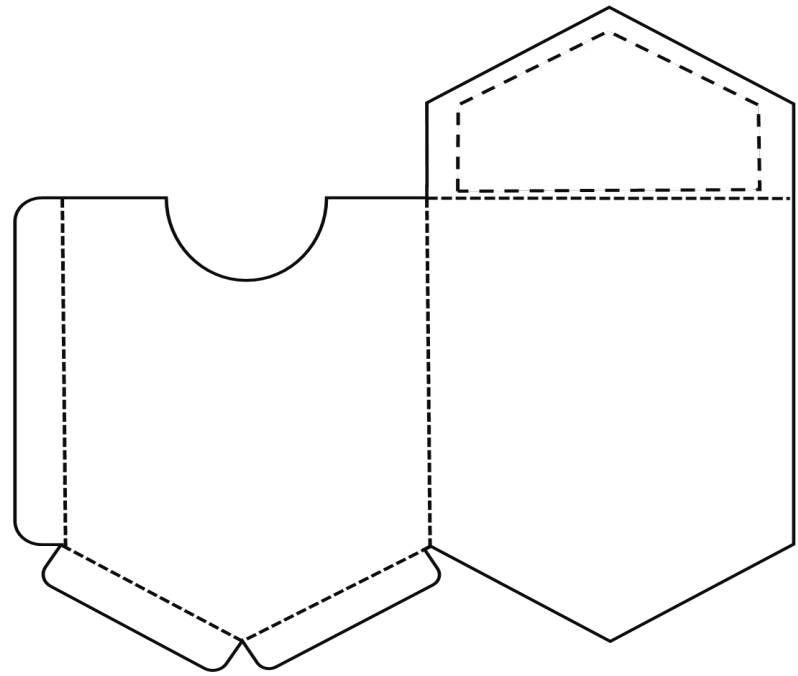
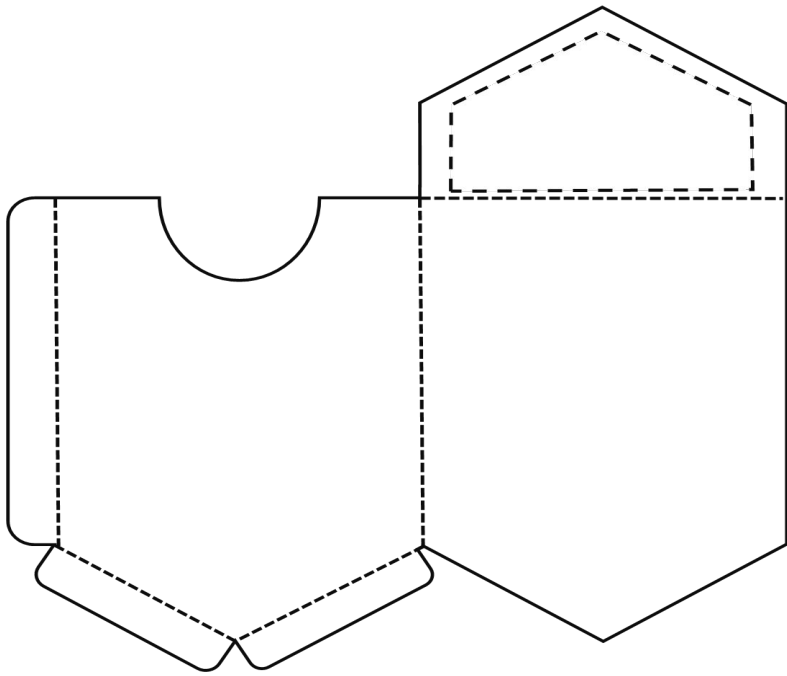

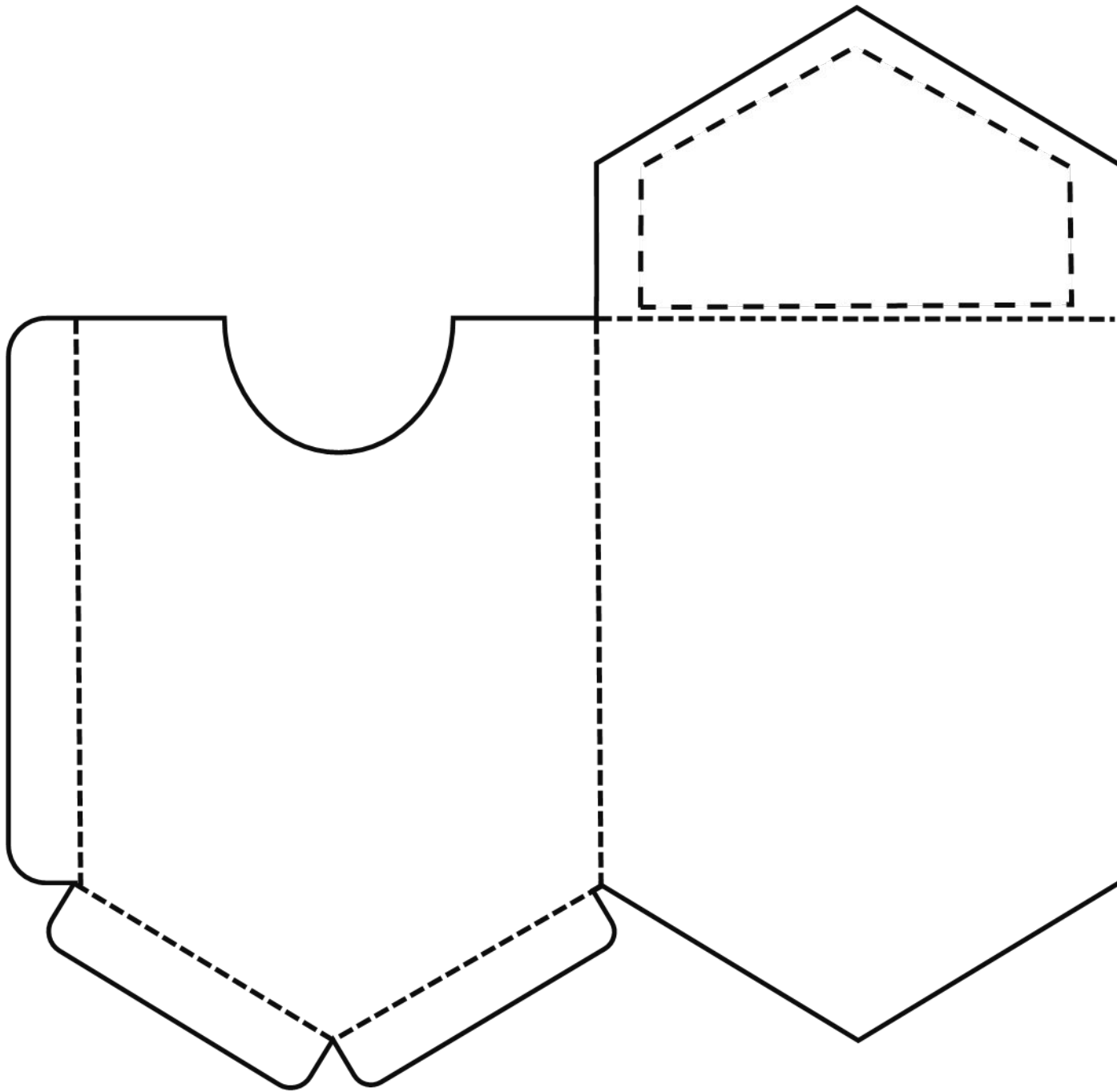

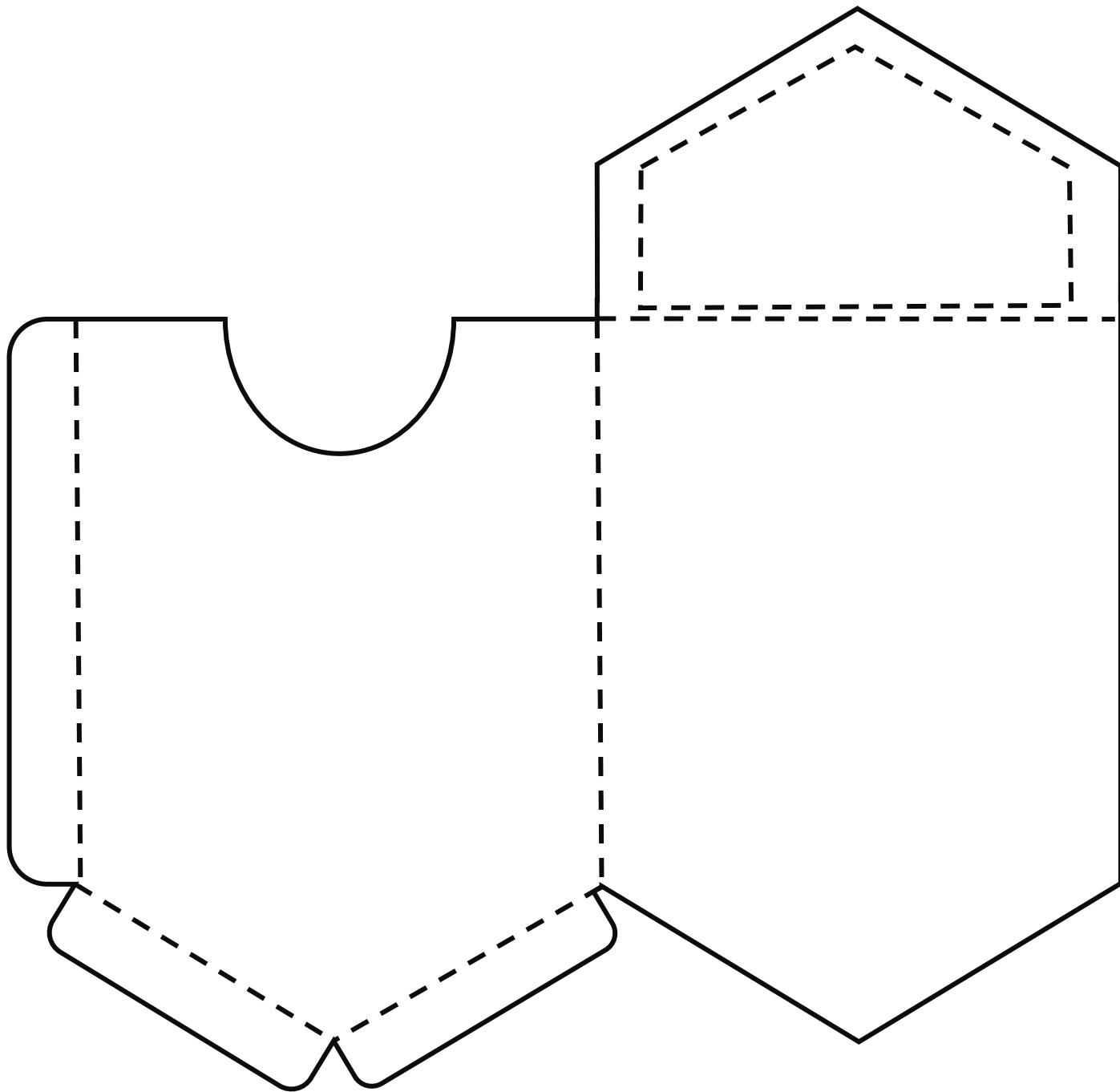

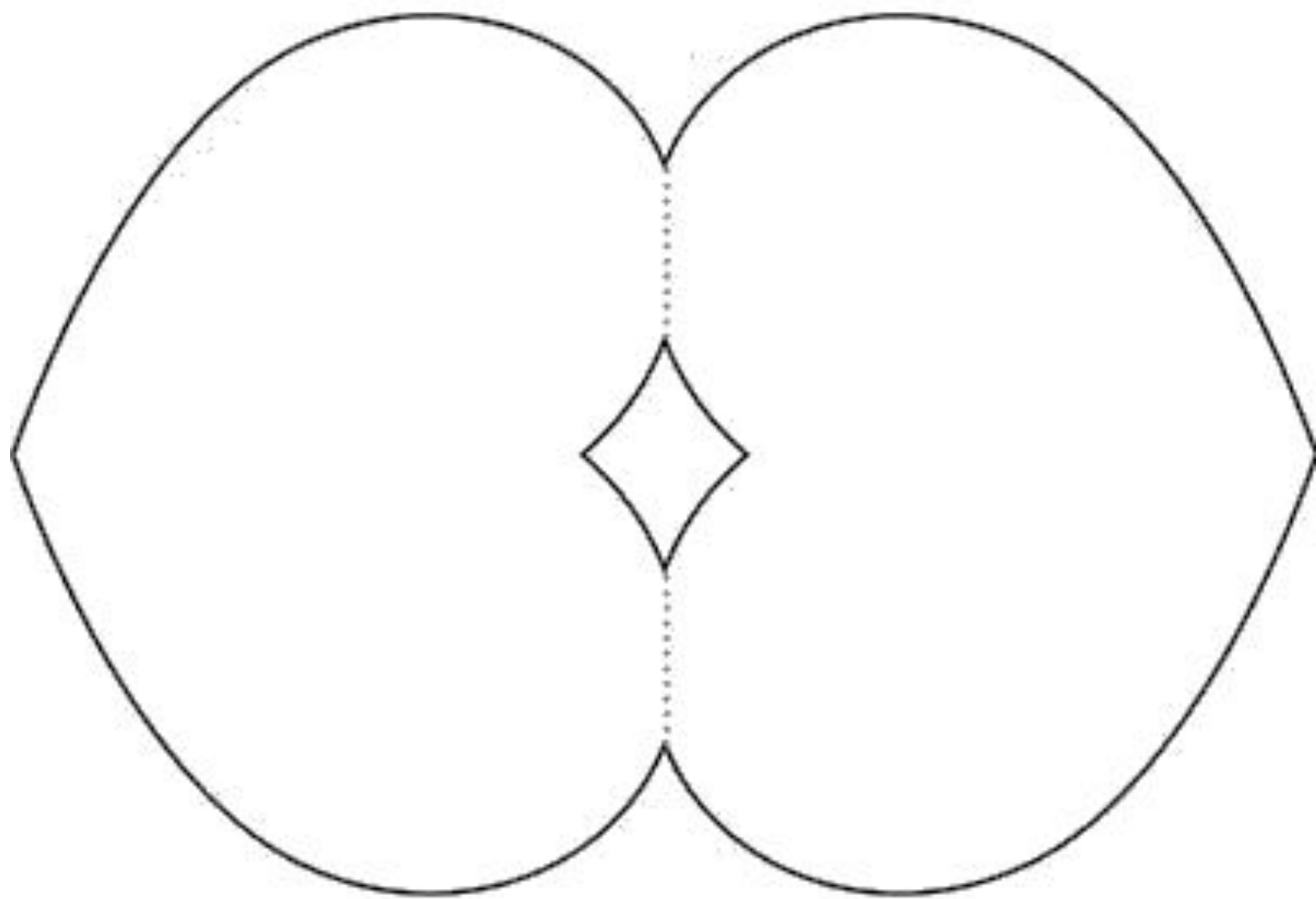

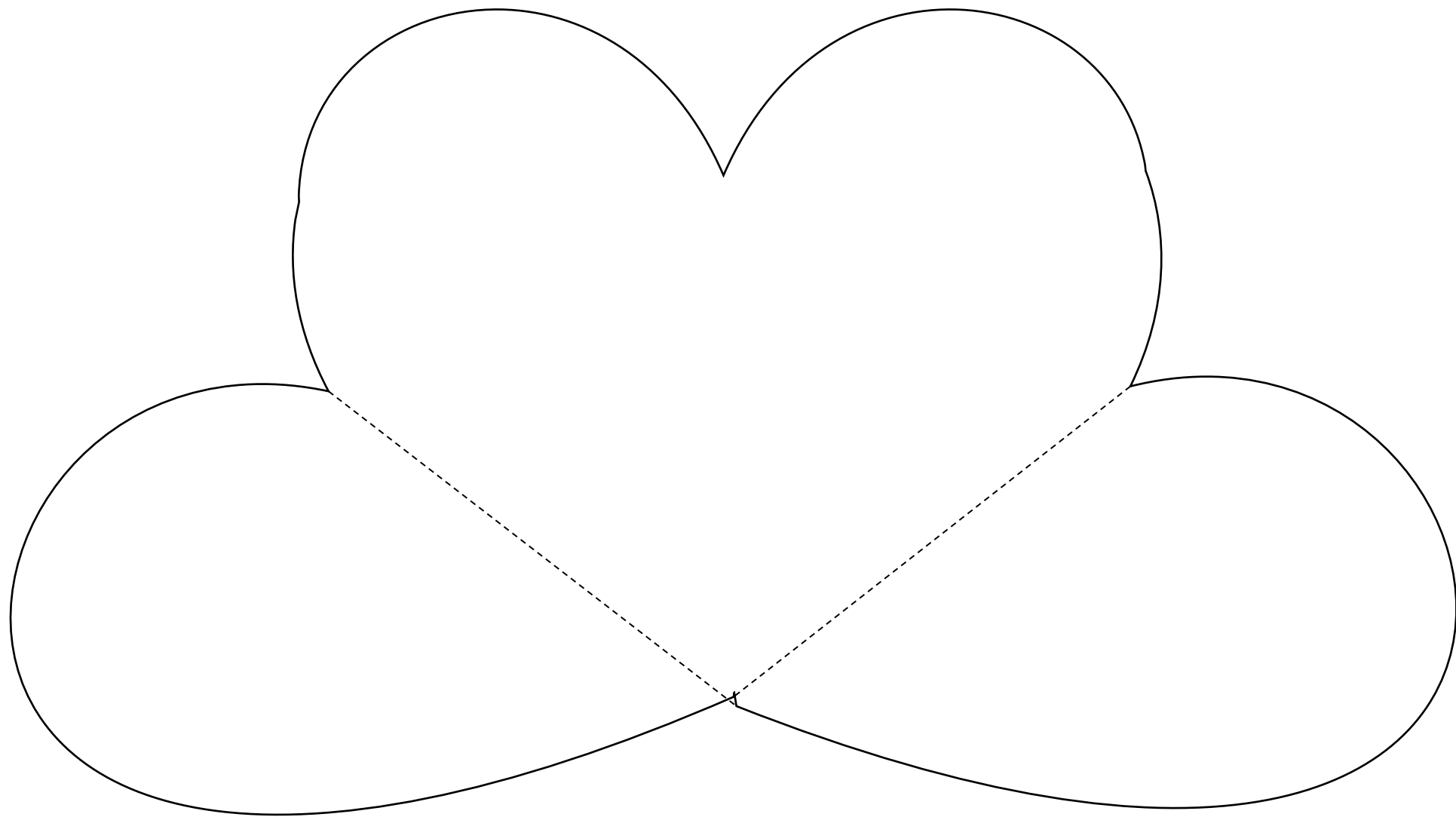

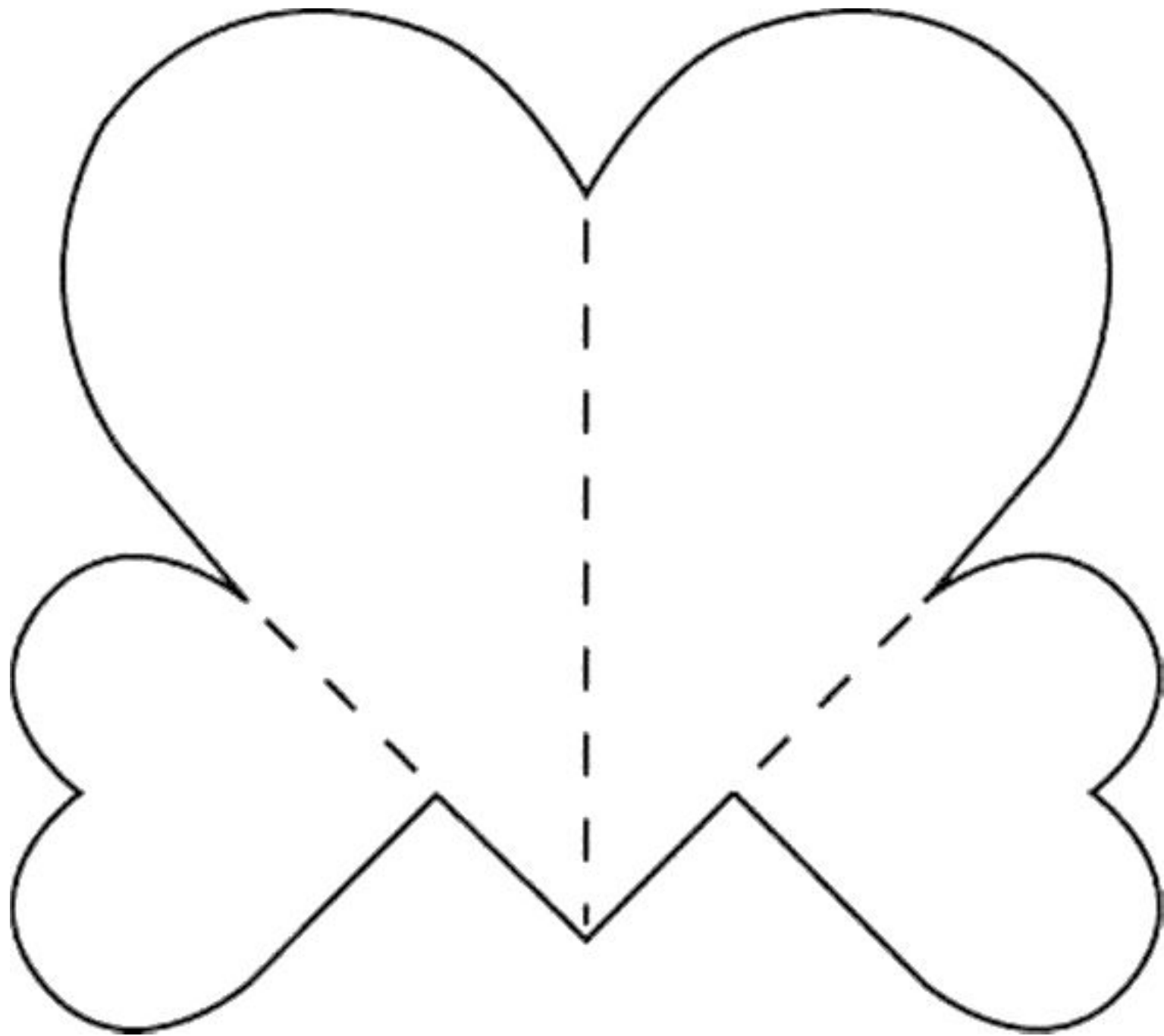

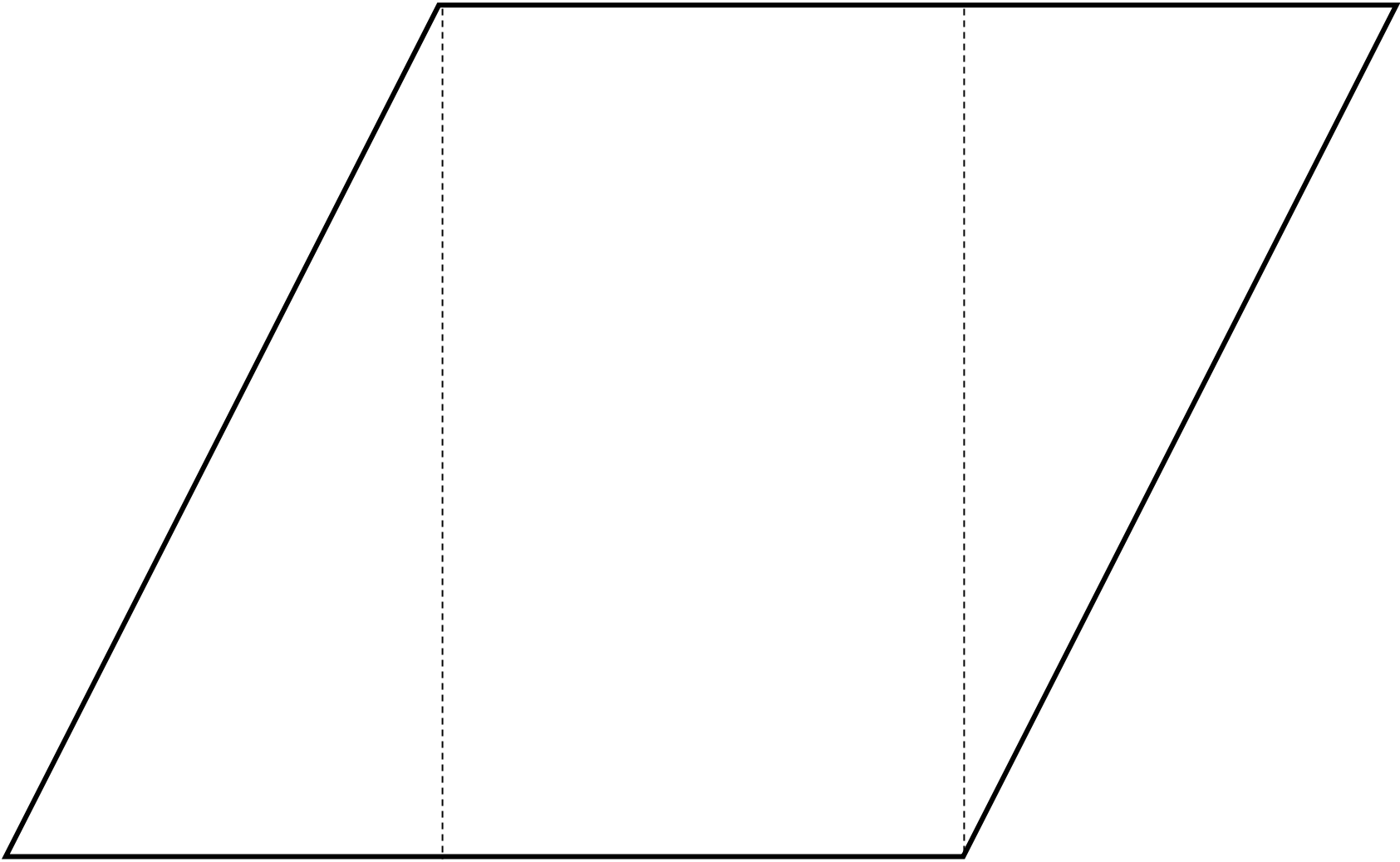

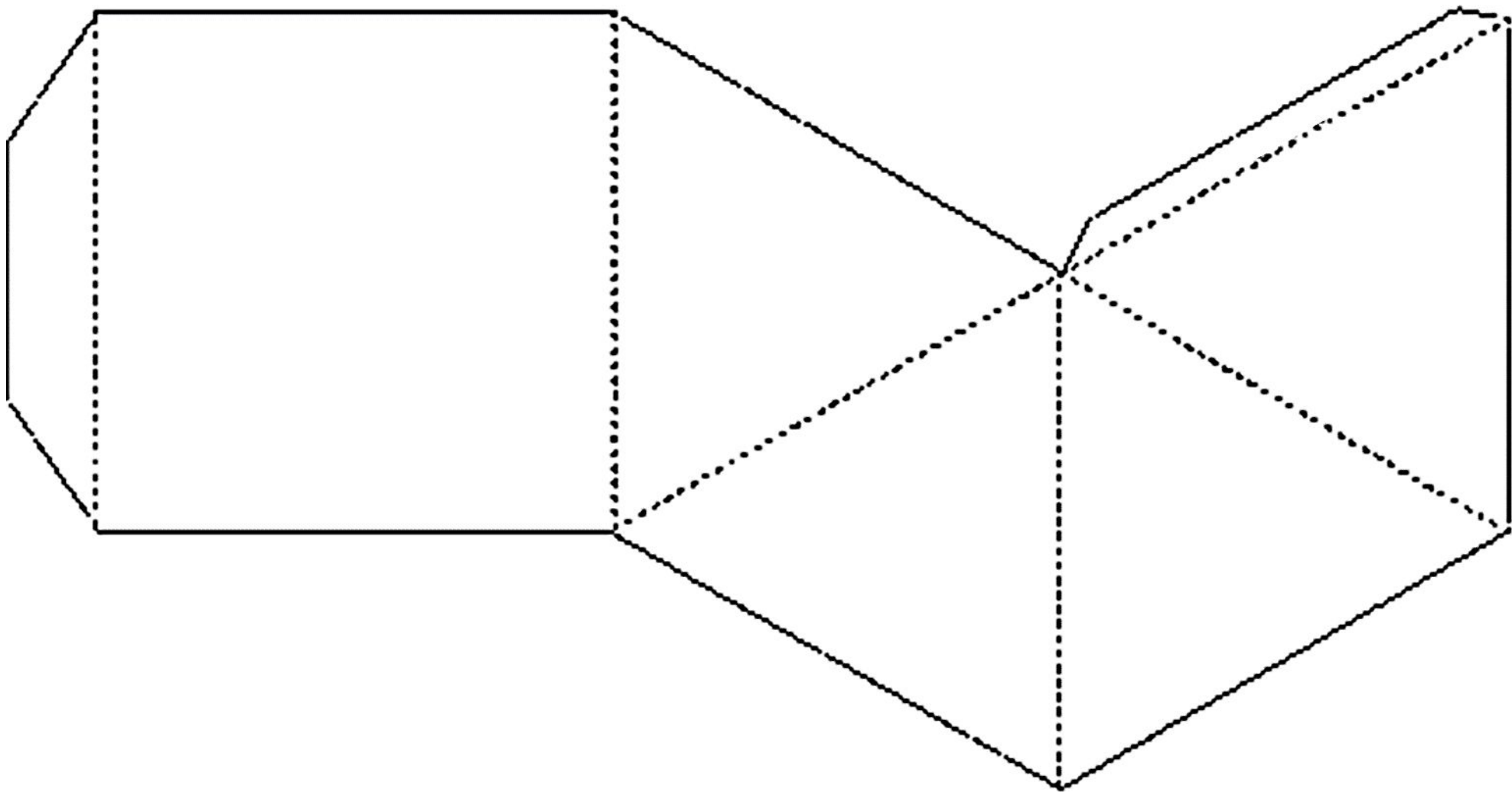

bottom flap

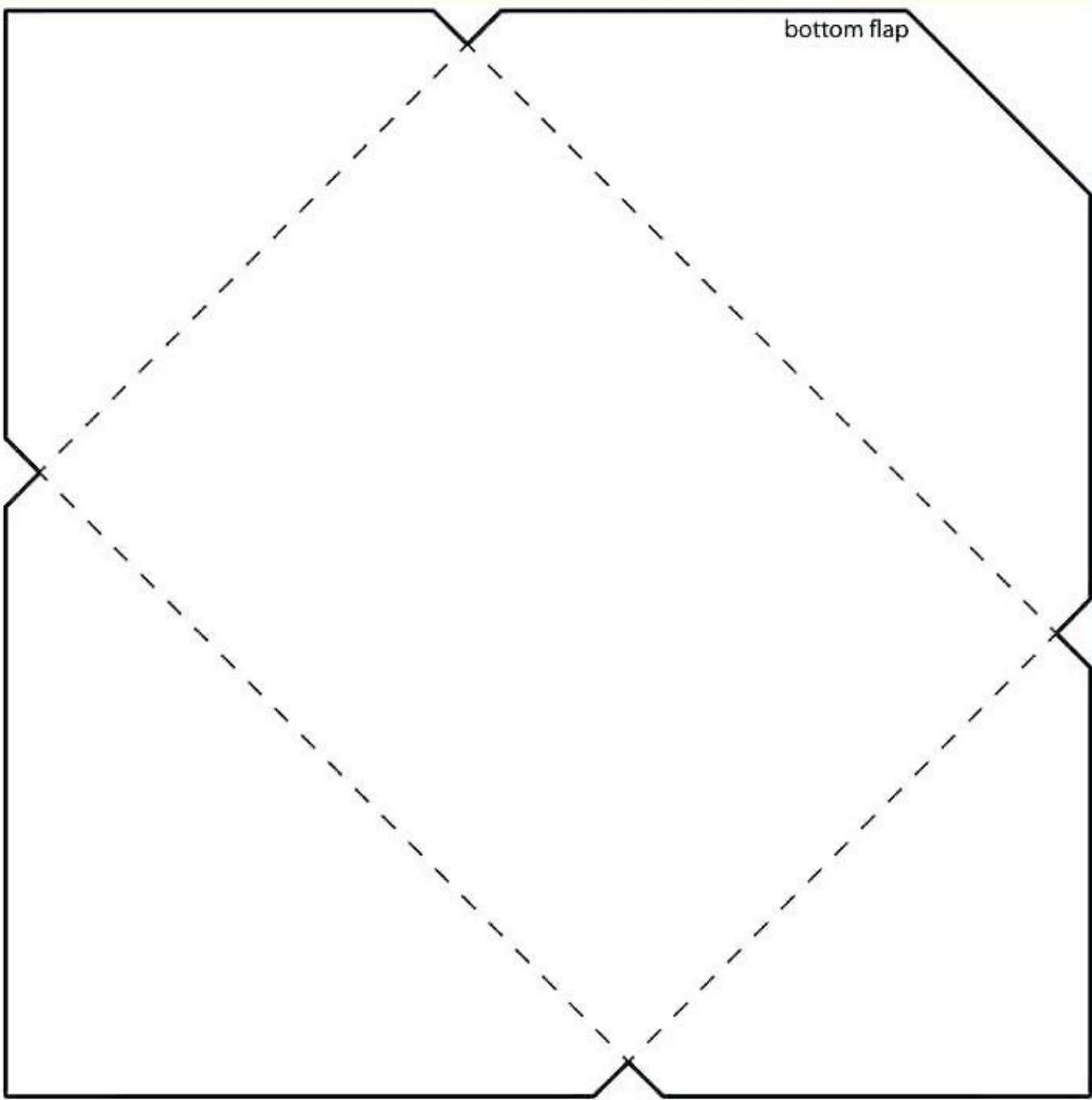

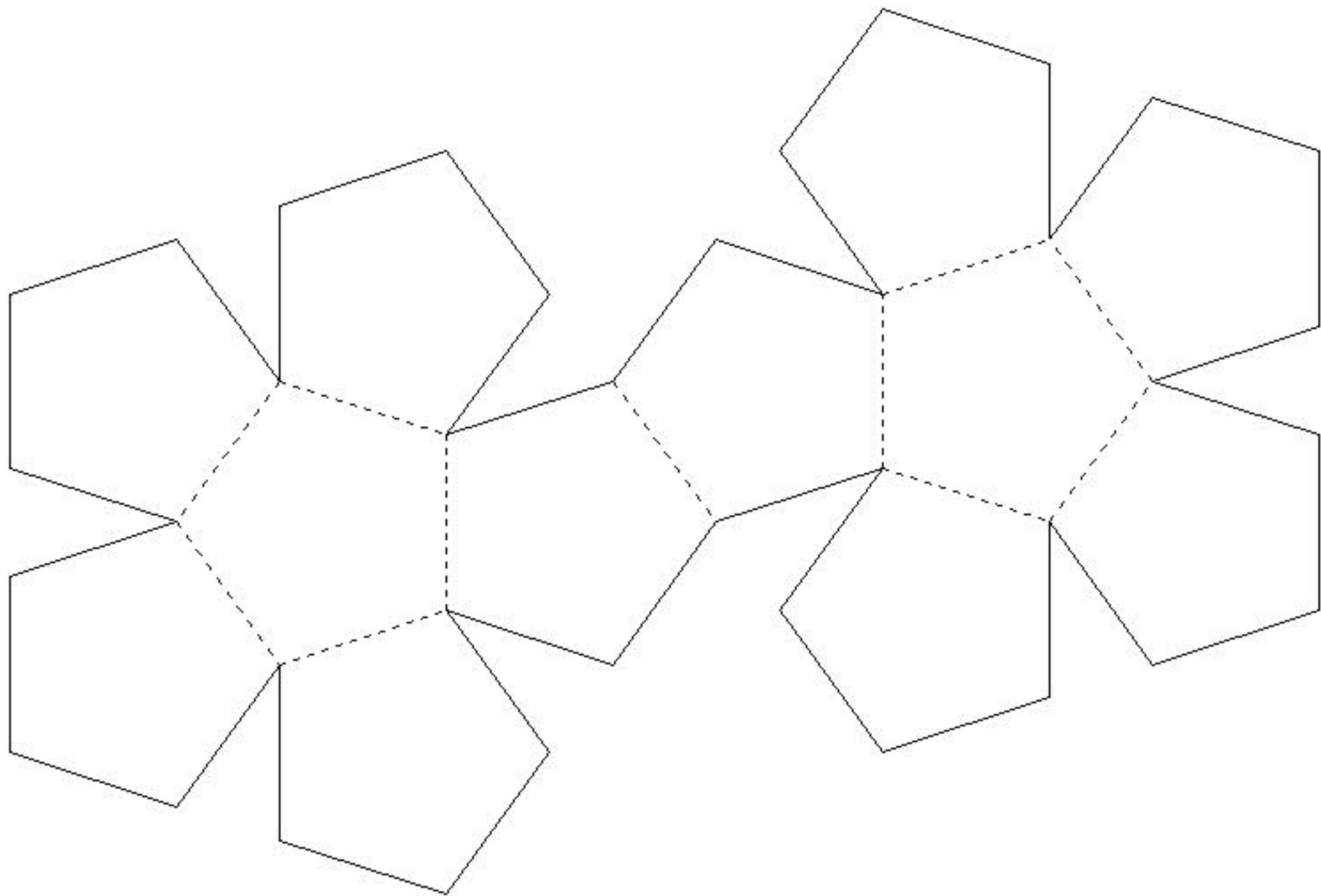

Arrow 4-page Mini-book

Cut out the 2 pages. Fold on the dotted lines. Place the inside pages inside the front page. Staple at the folded edge.

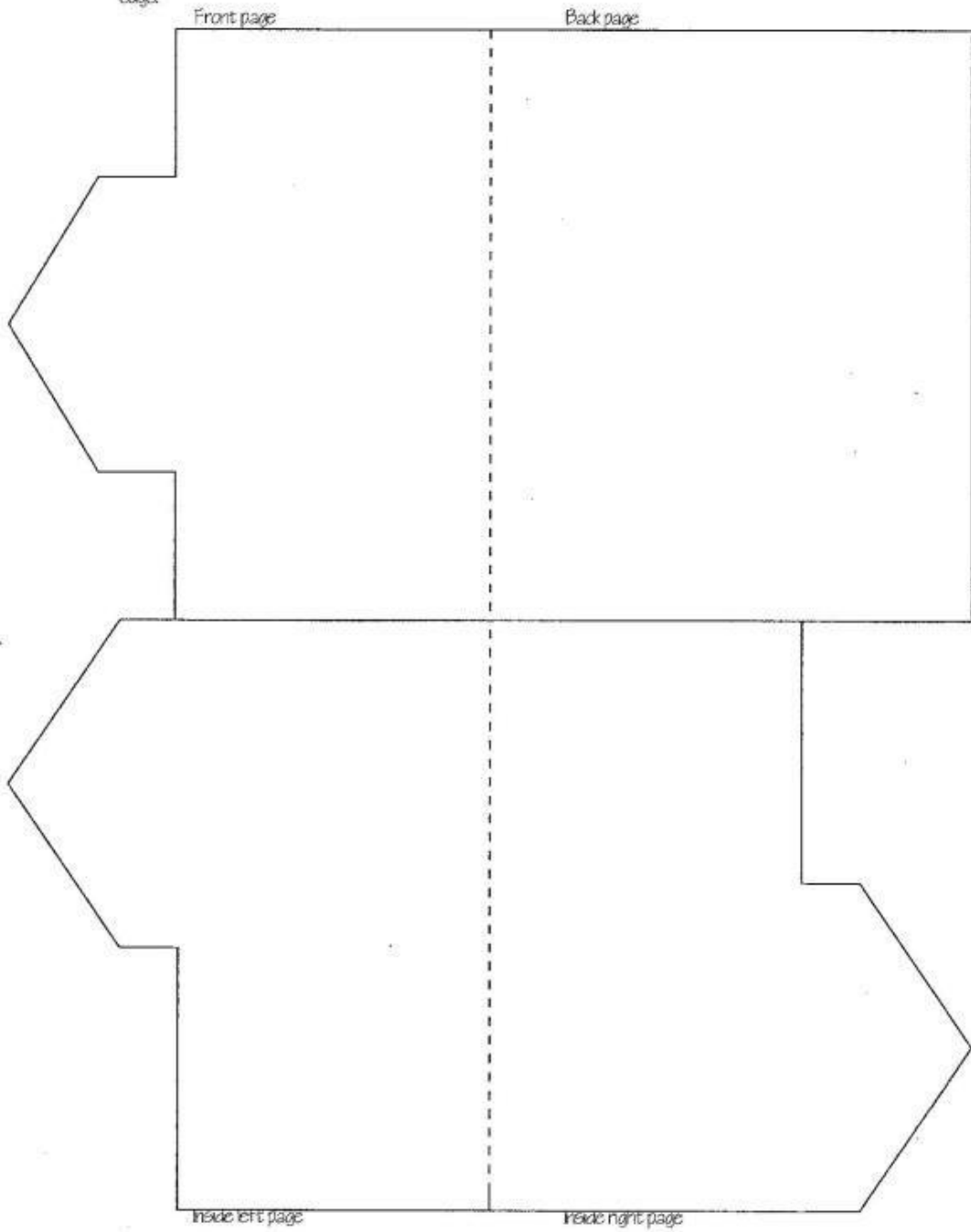

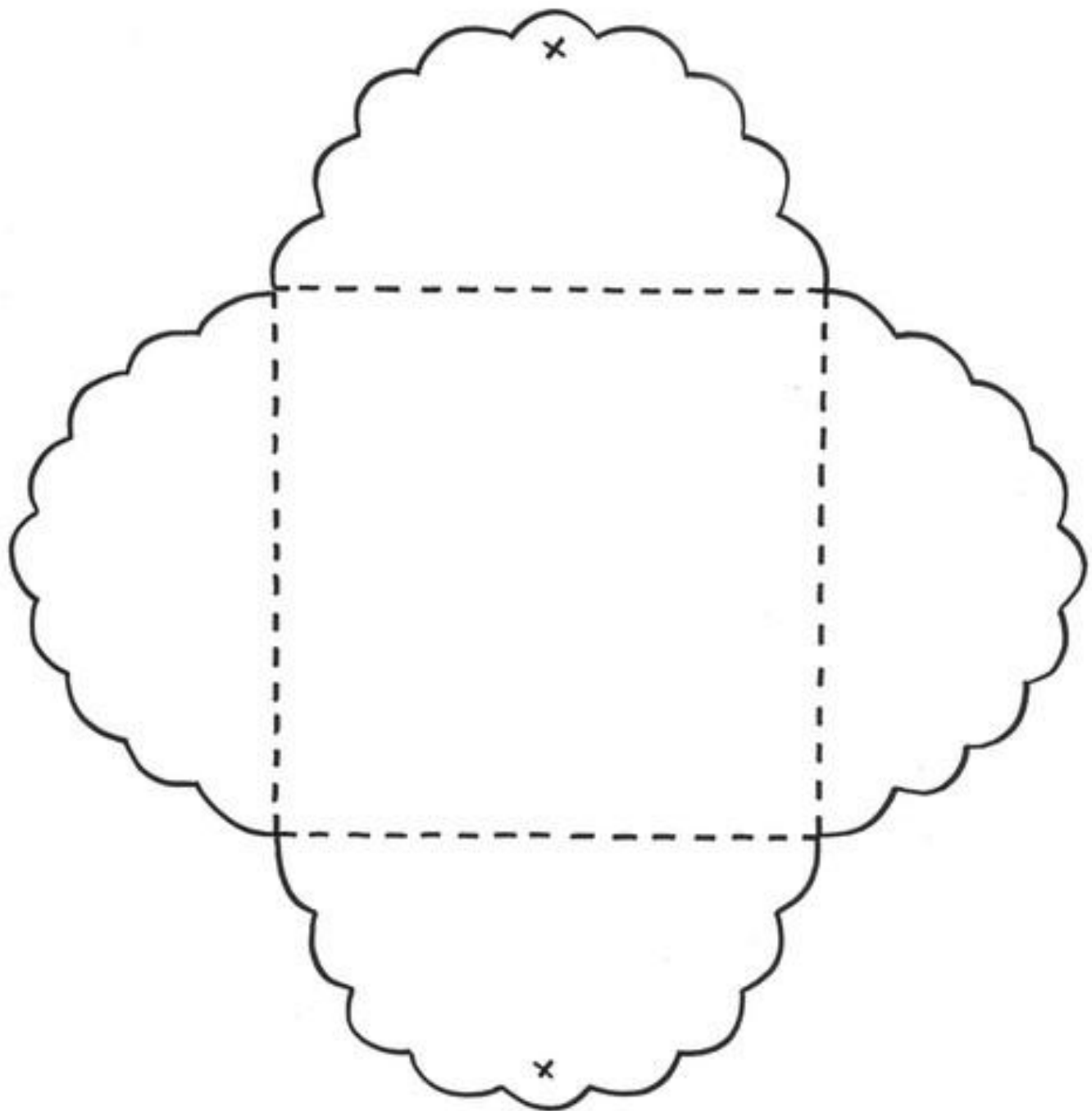

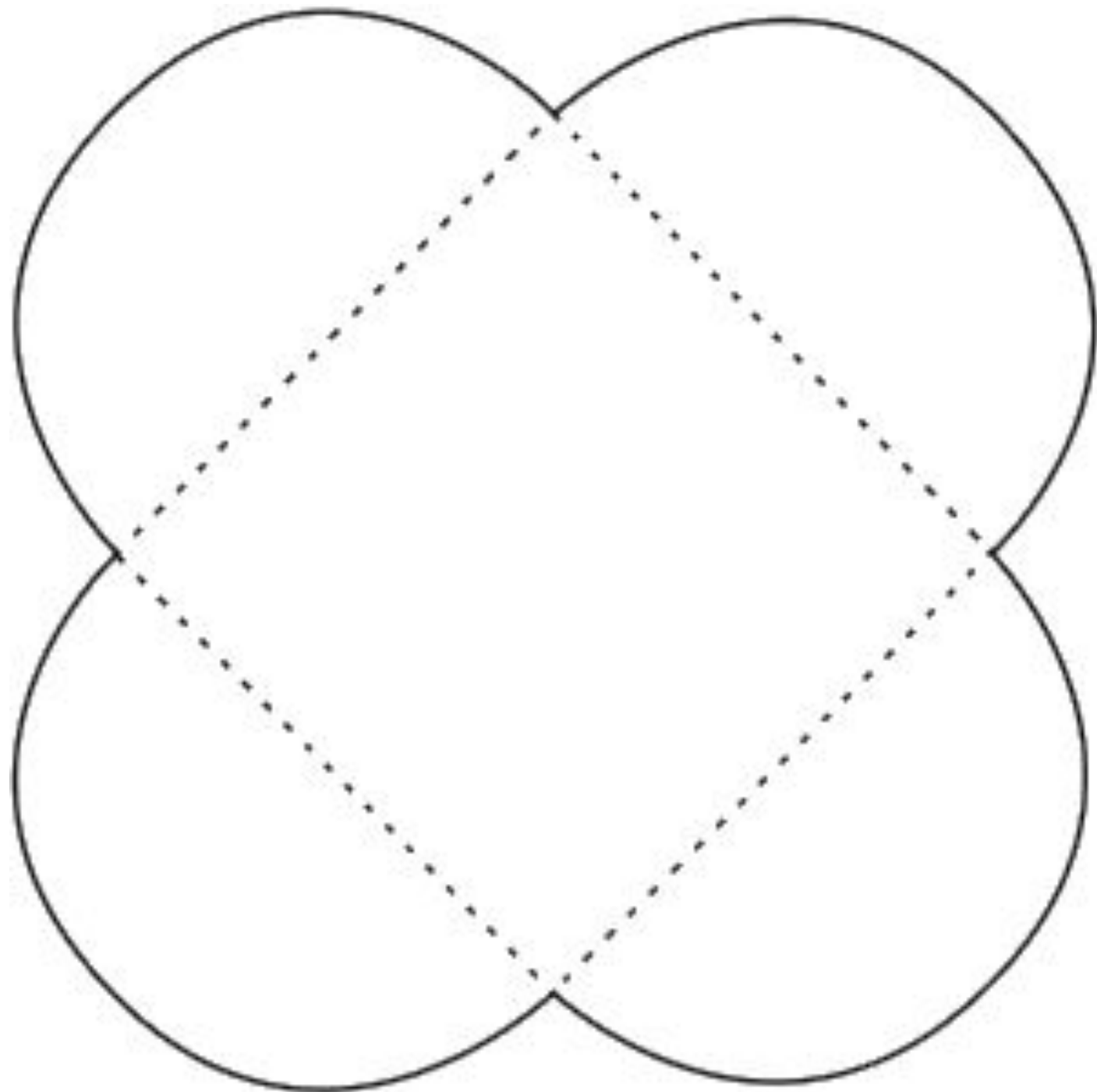

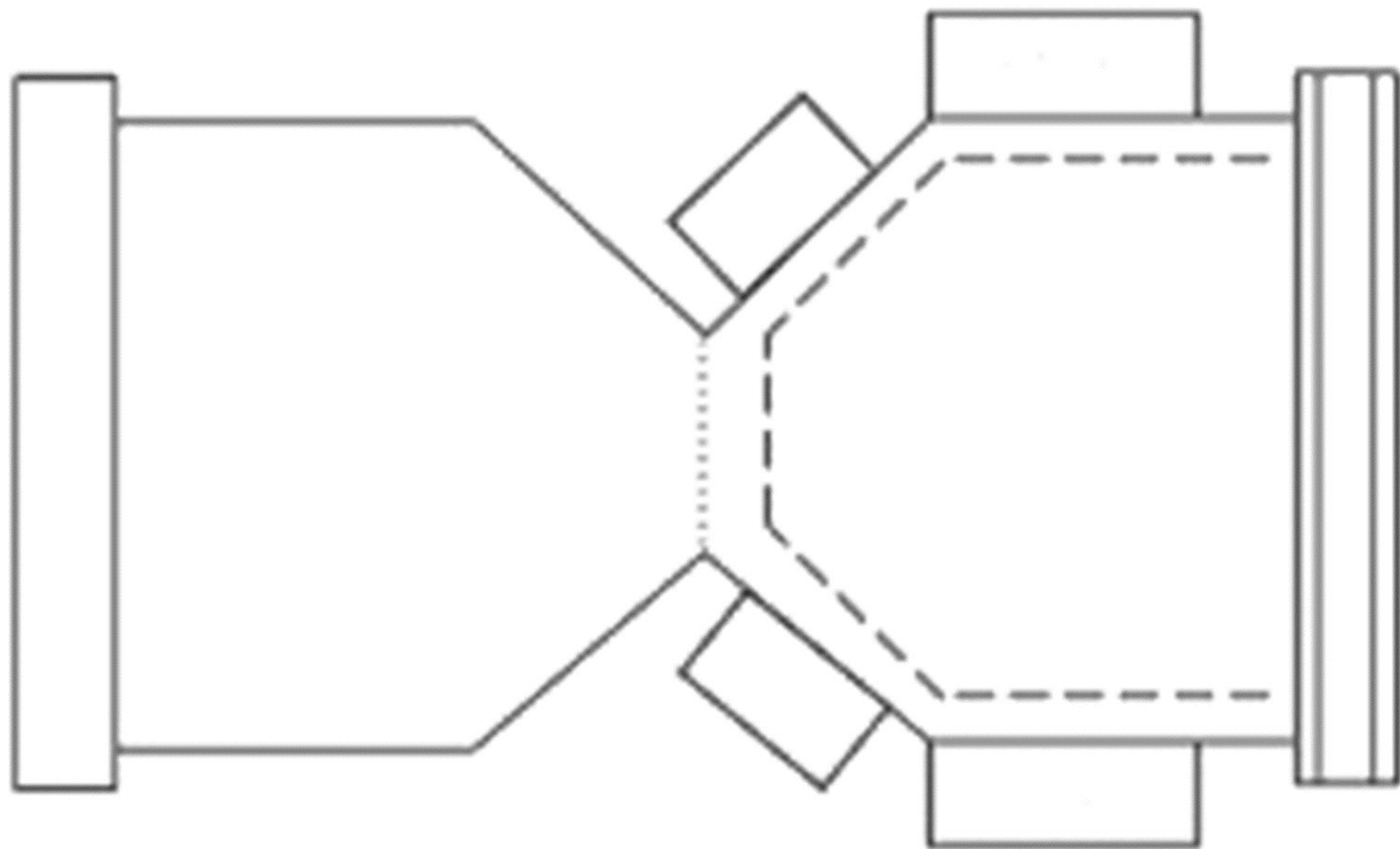

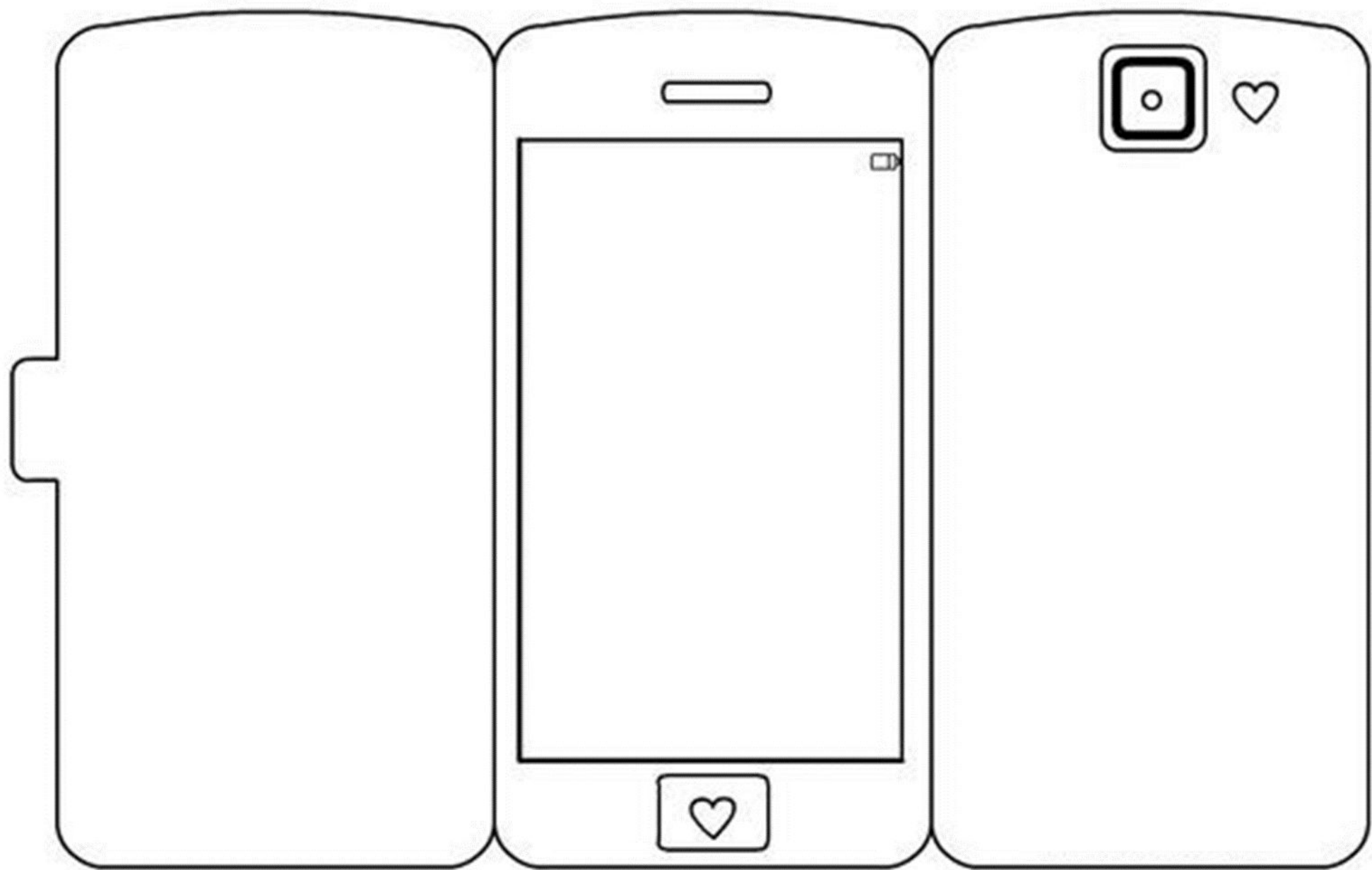

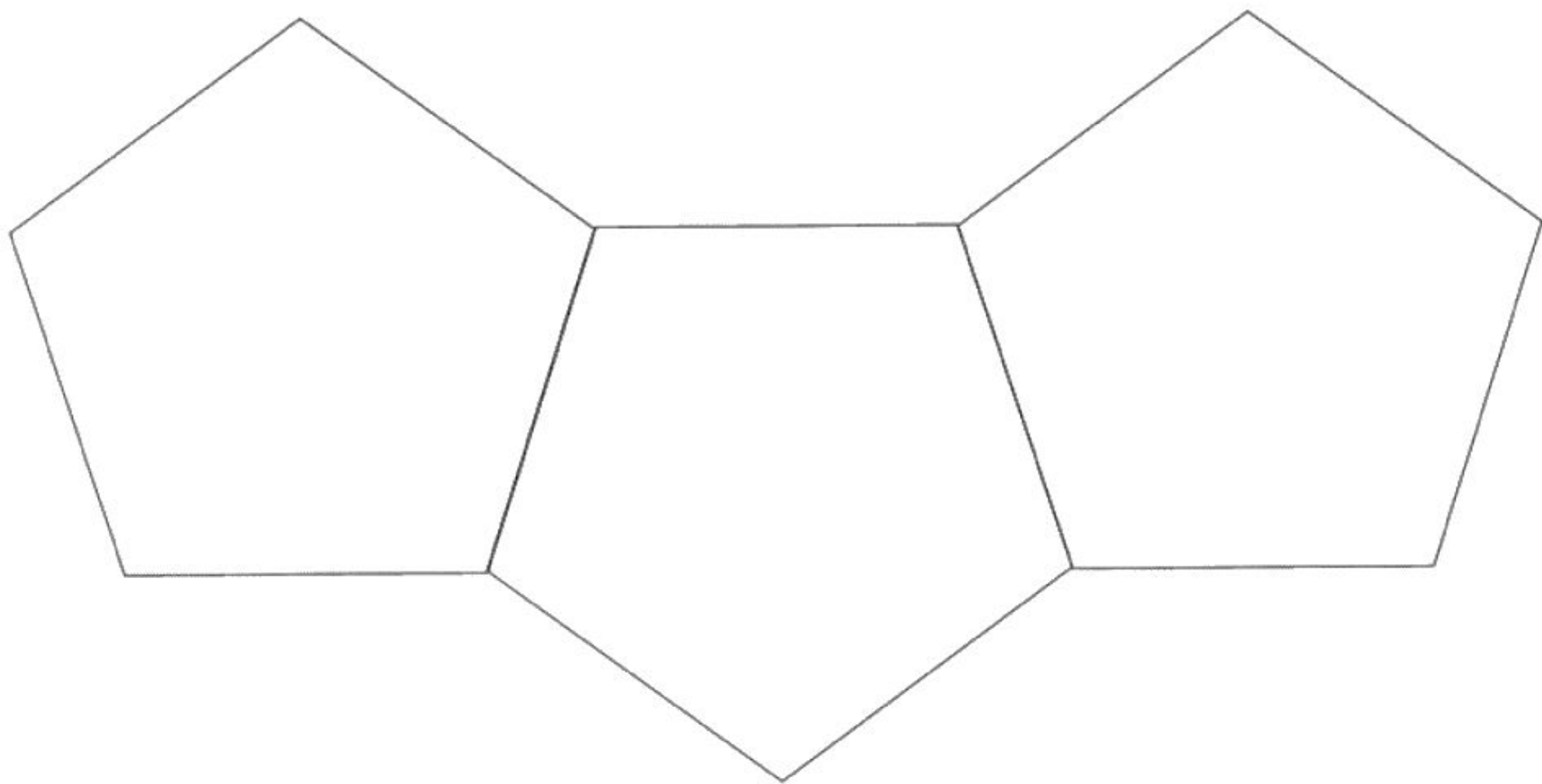

Flower Pot Template

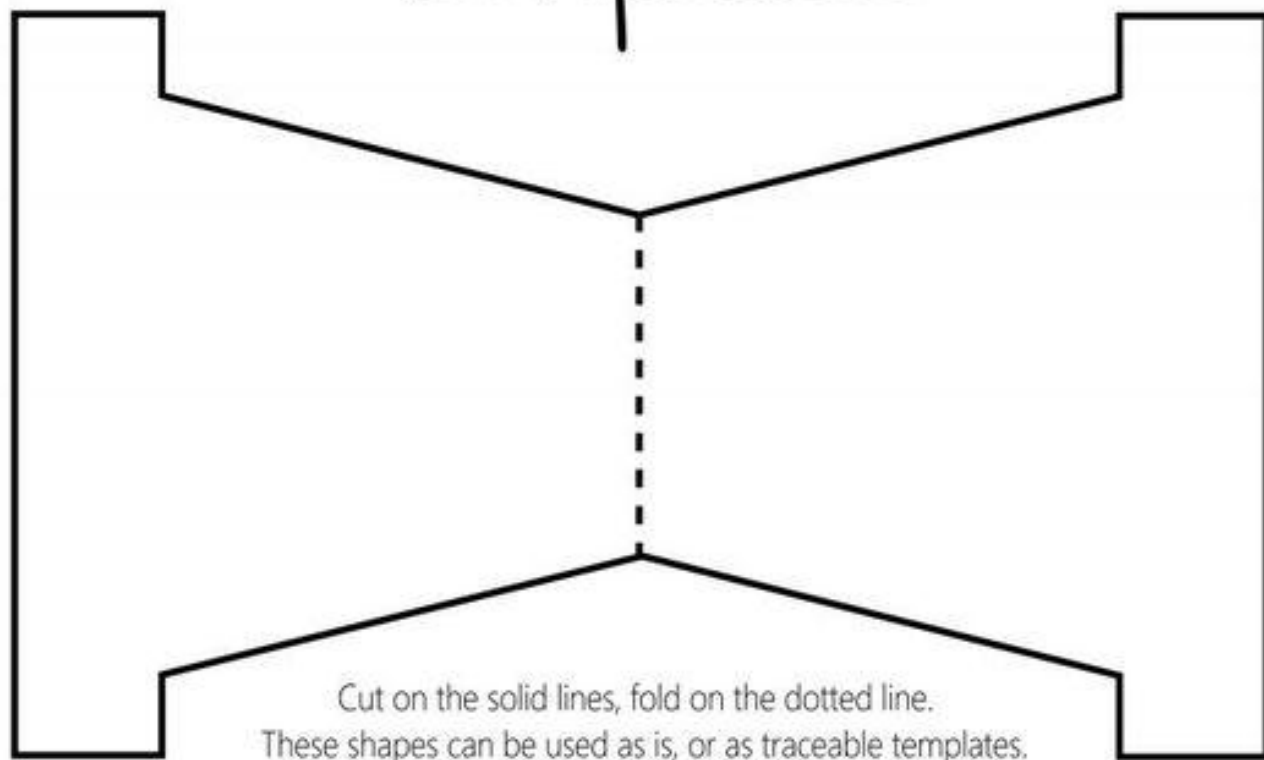

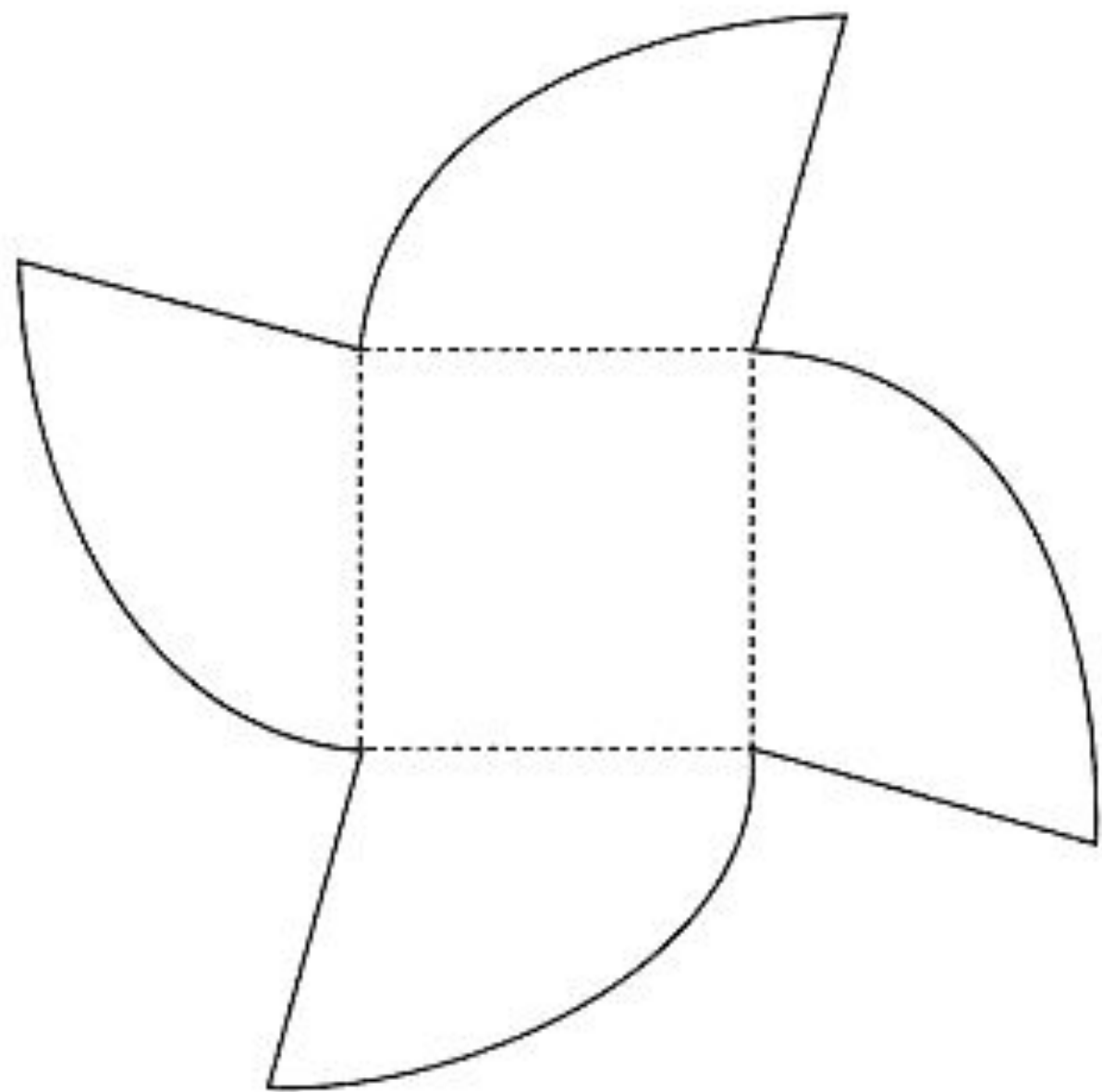

CAJA HEXAGONAL (INTERIOR)

PARTE 1/5

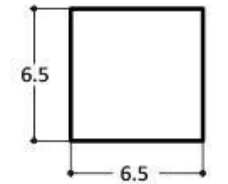
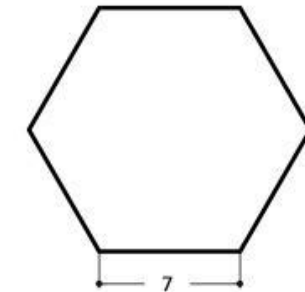
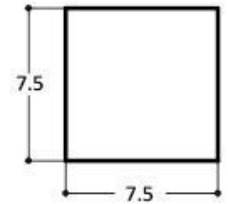
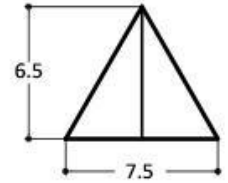
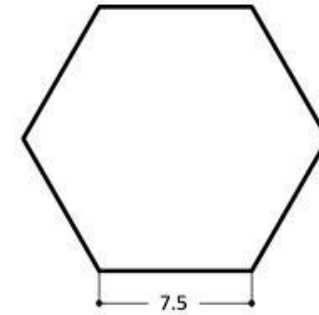
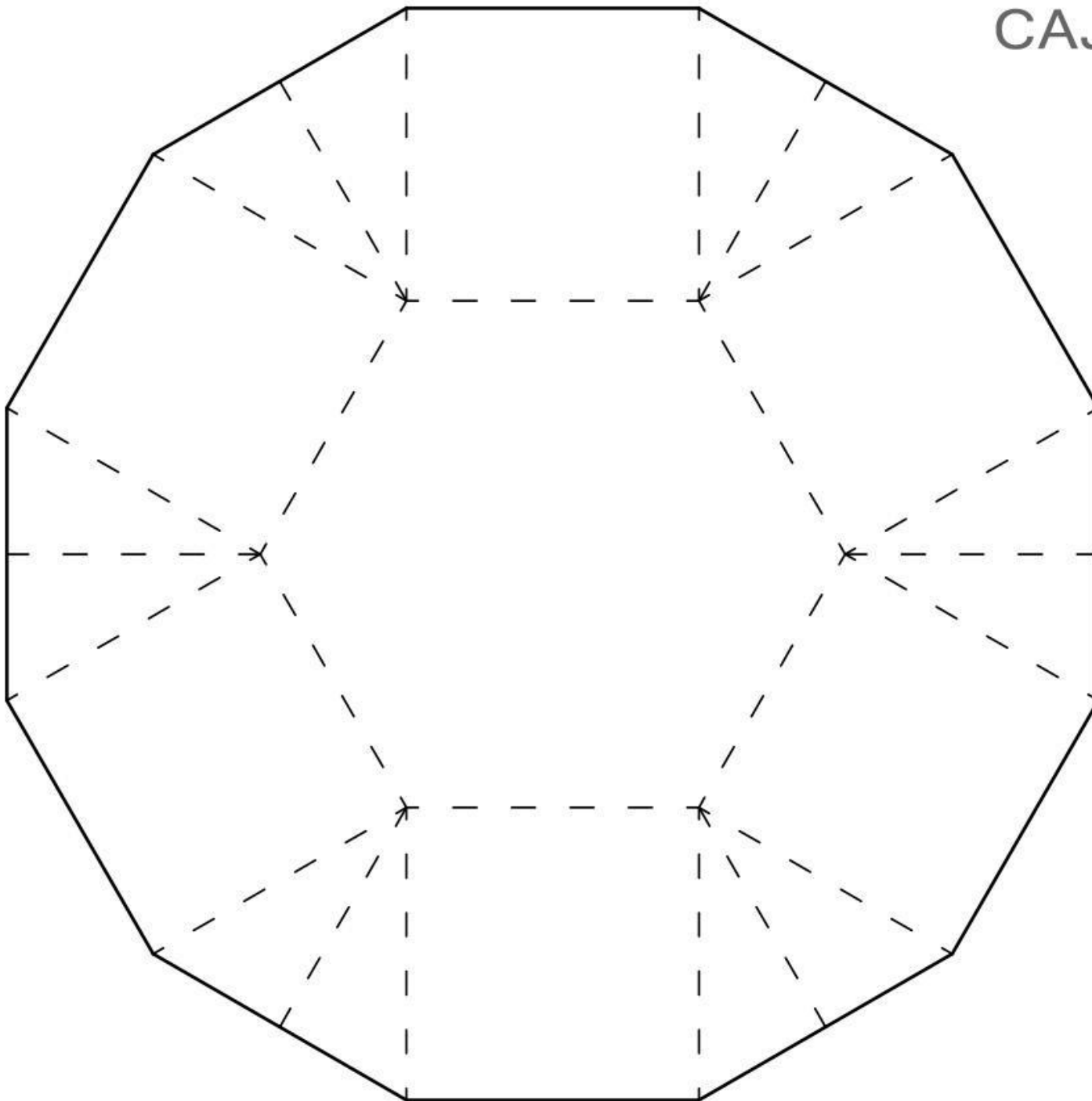

INSTRUCCIONES:

- Imprimir en A3 o dibujar siguiendo las medidas.
- Cortar líneas continuas.
- Doblar líneas discontinuas.
- Pegar ventanas interiores.
- Instrucciones en vídeo.

Grundform 13:

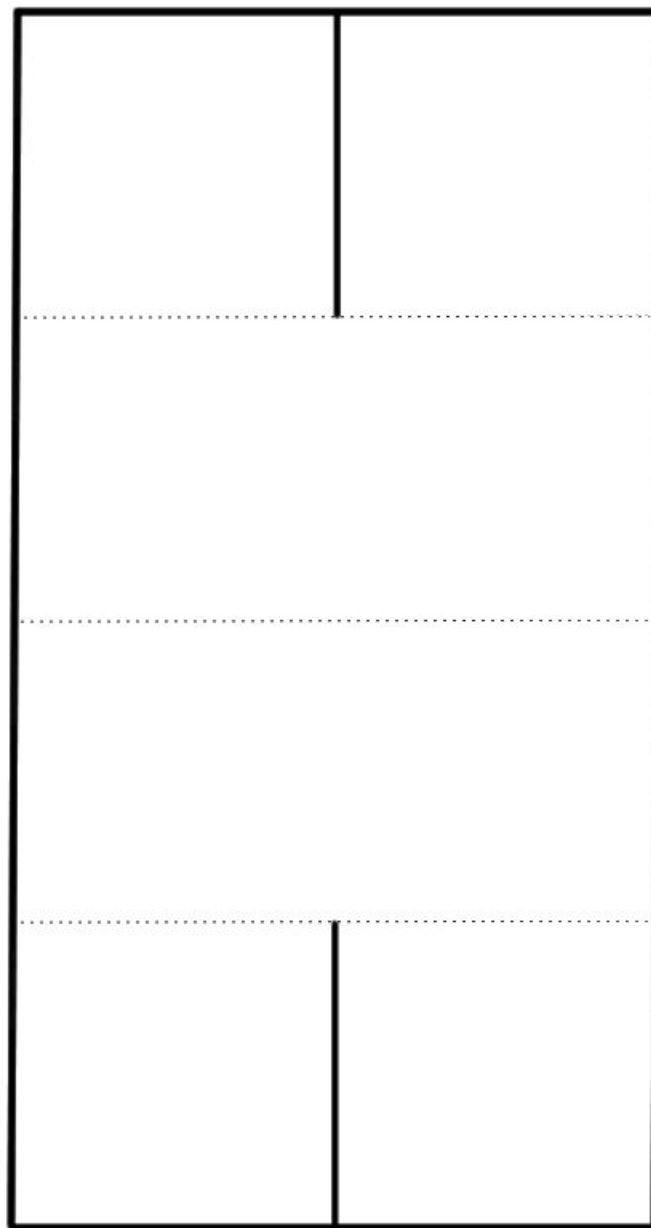
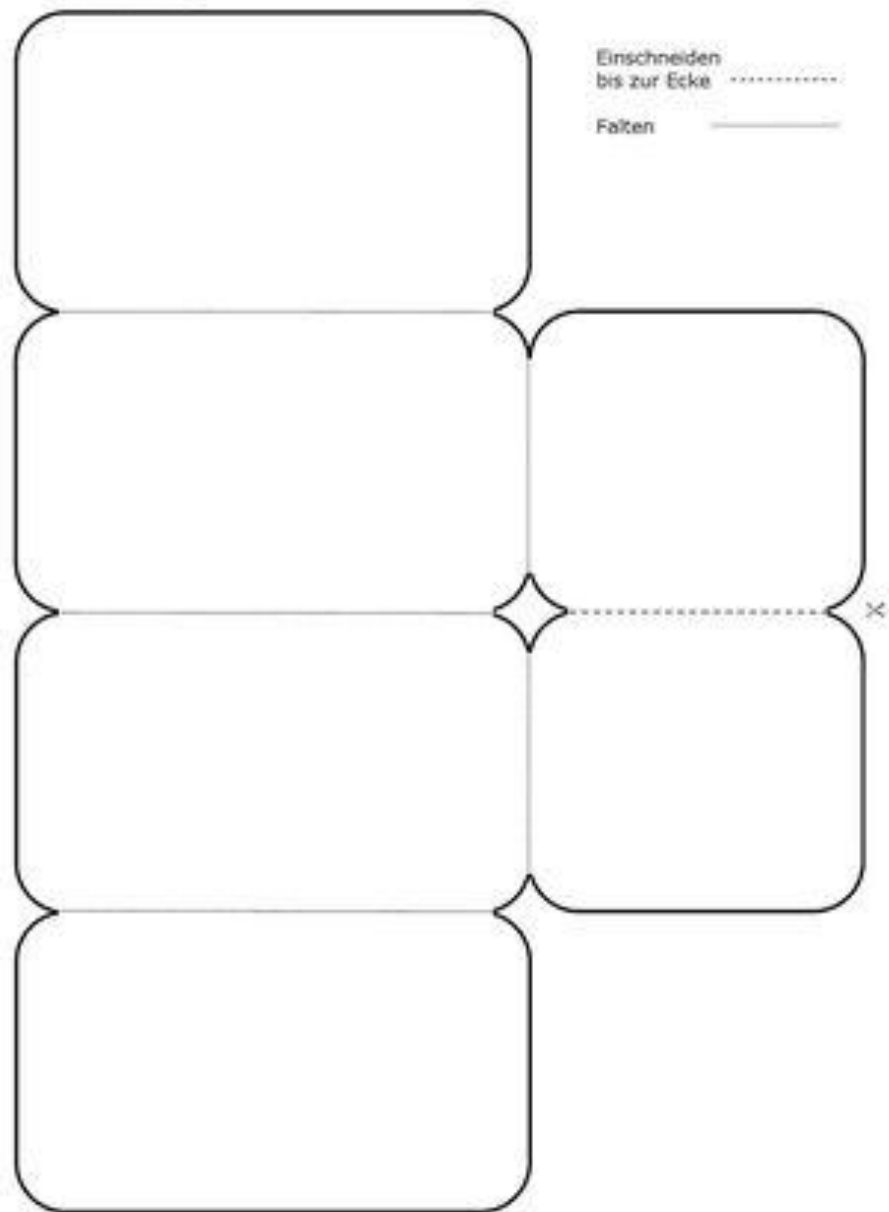

Cut along solid lines. Fold on the outer dotted lines so writing is to the outside. Fold on middle dotted line.

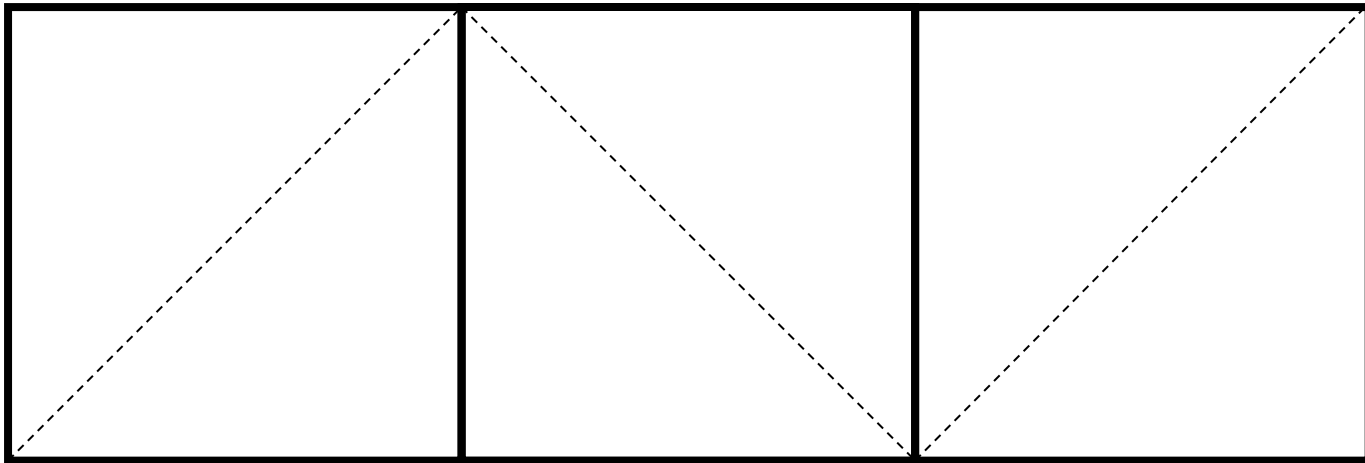
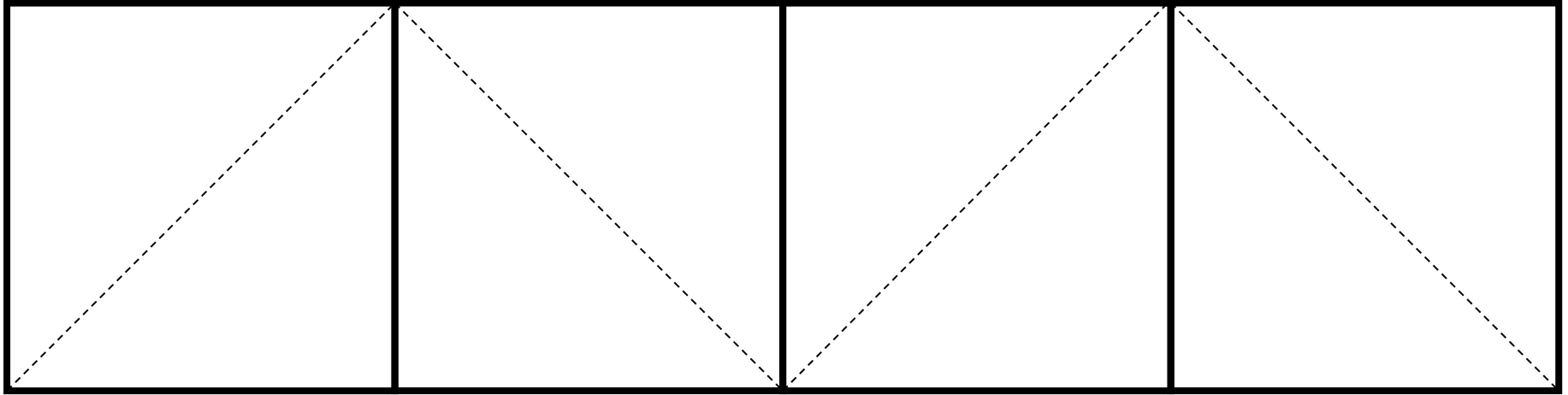

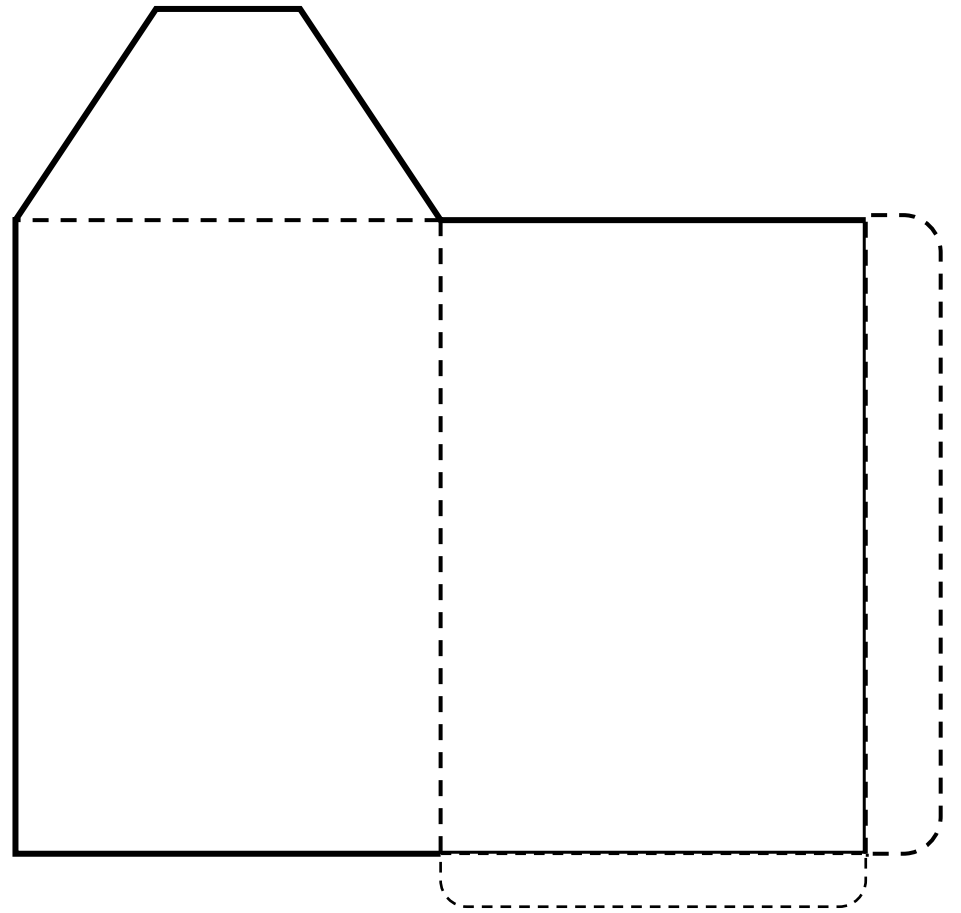
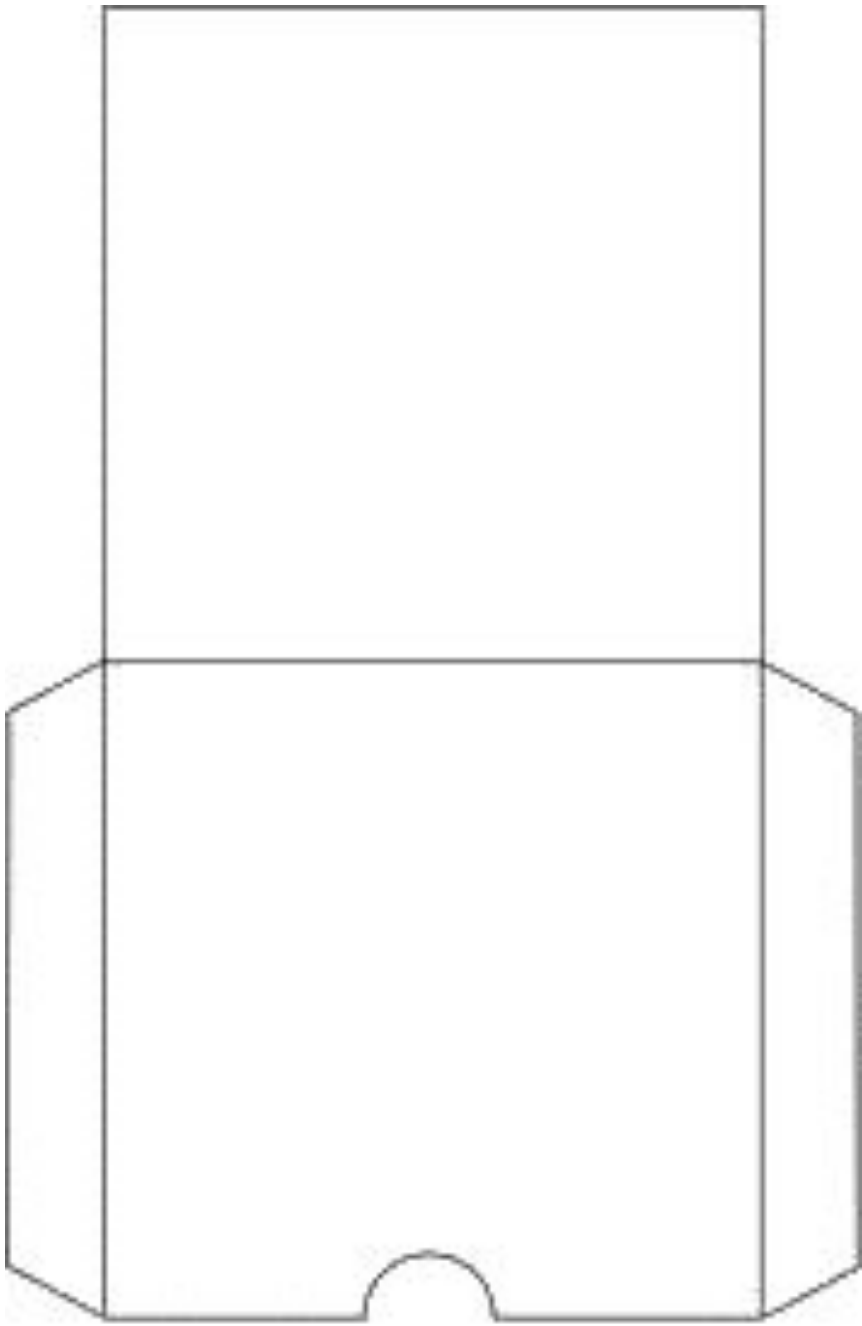

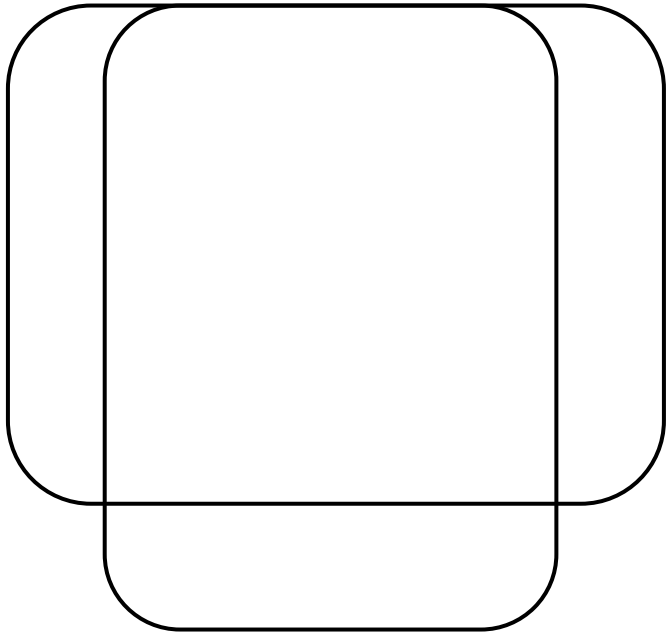

Template
for card to
put inside

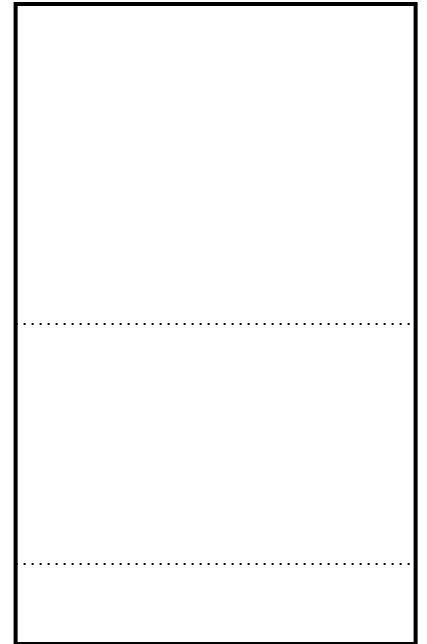
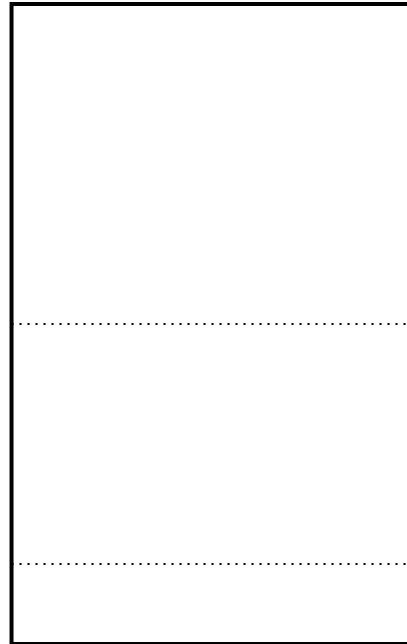
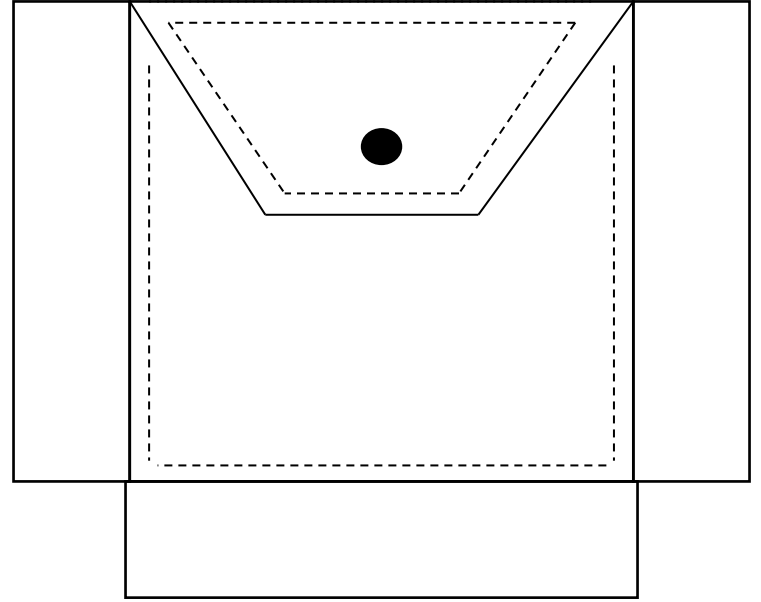

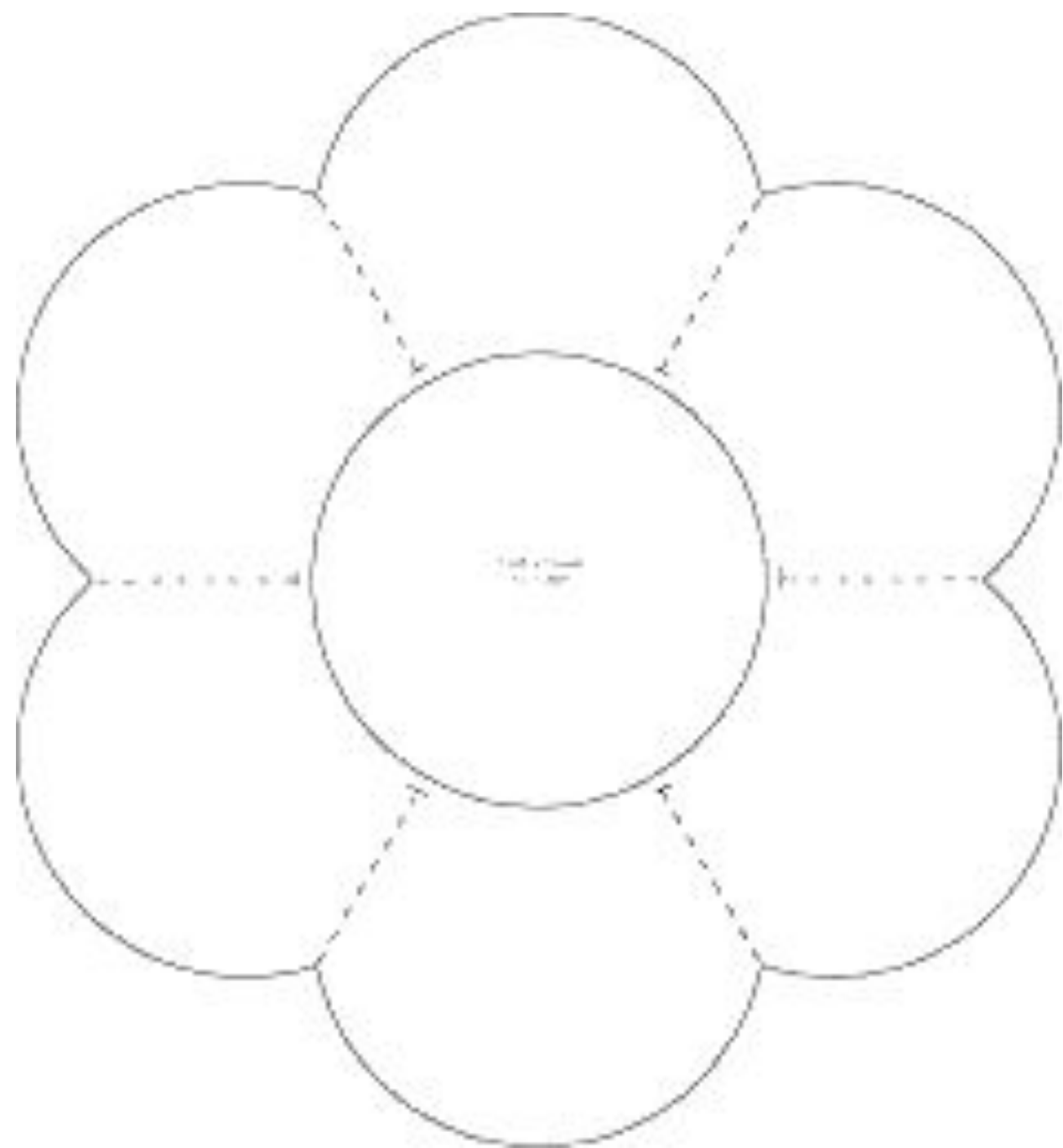

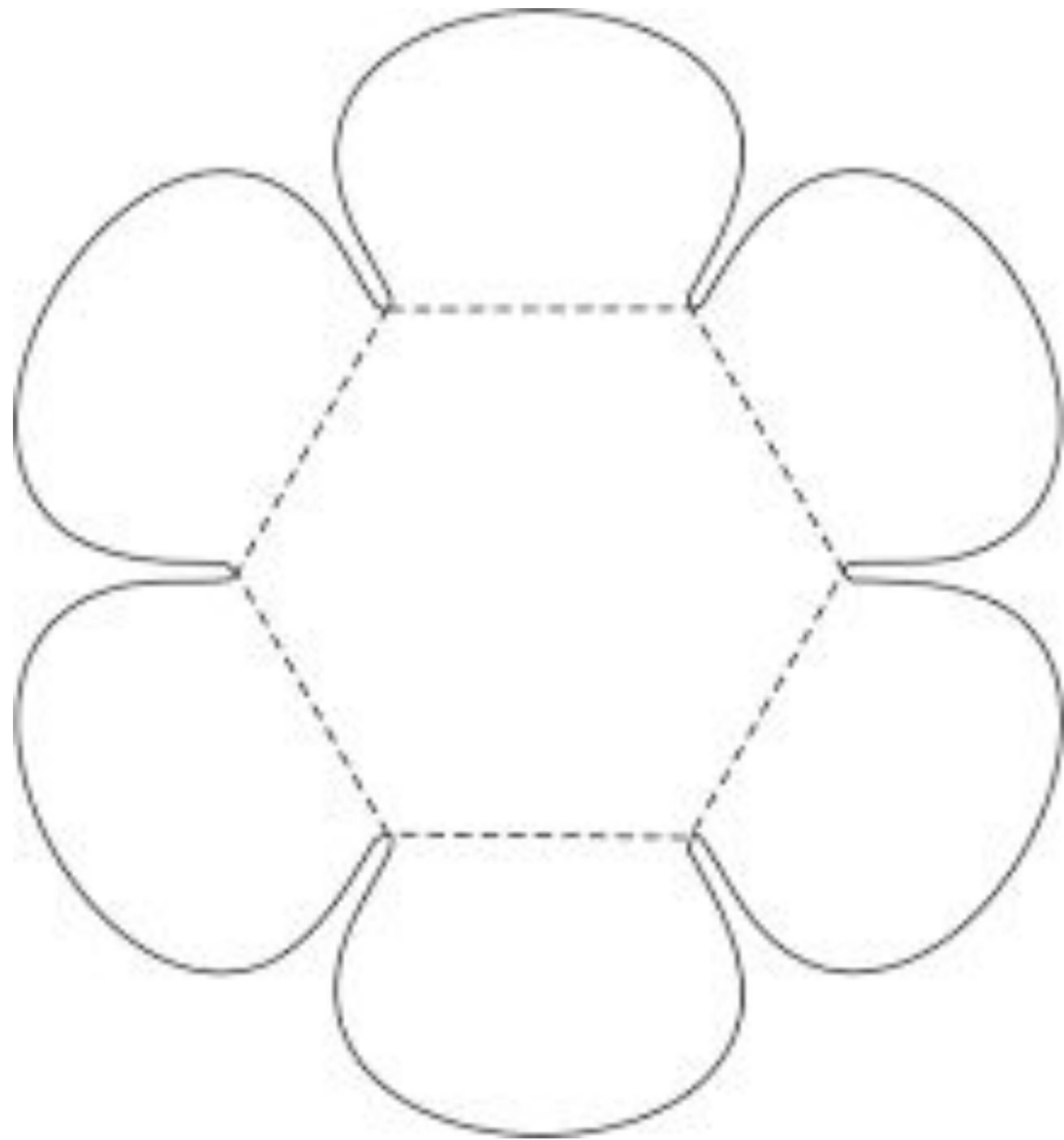

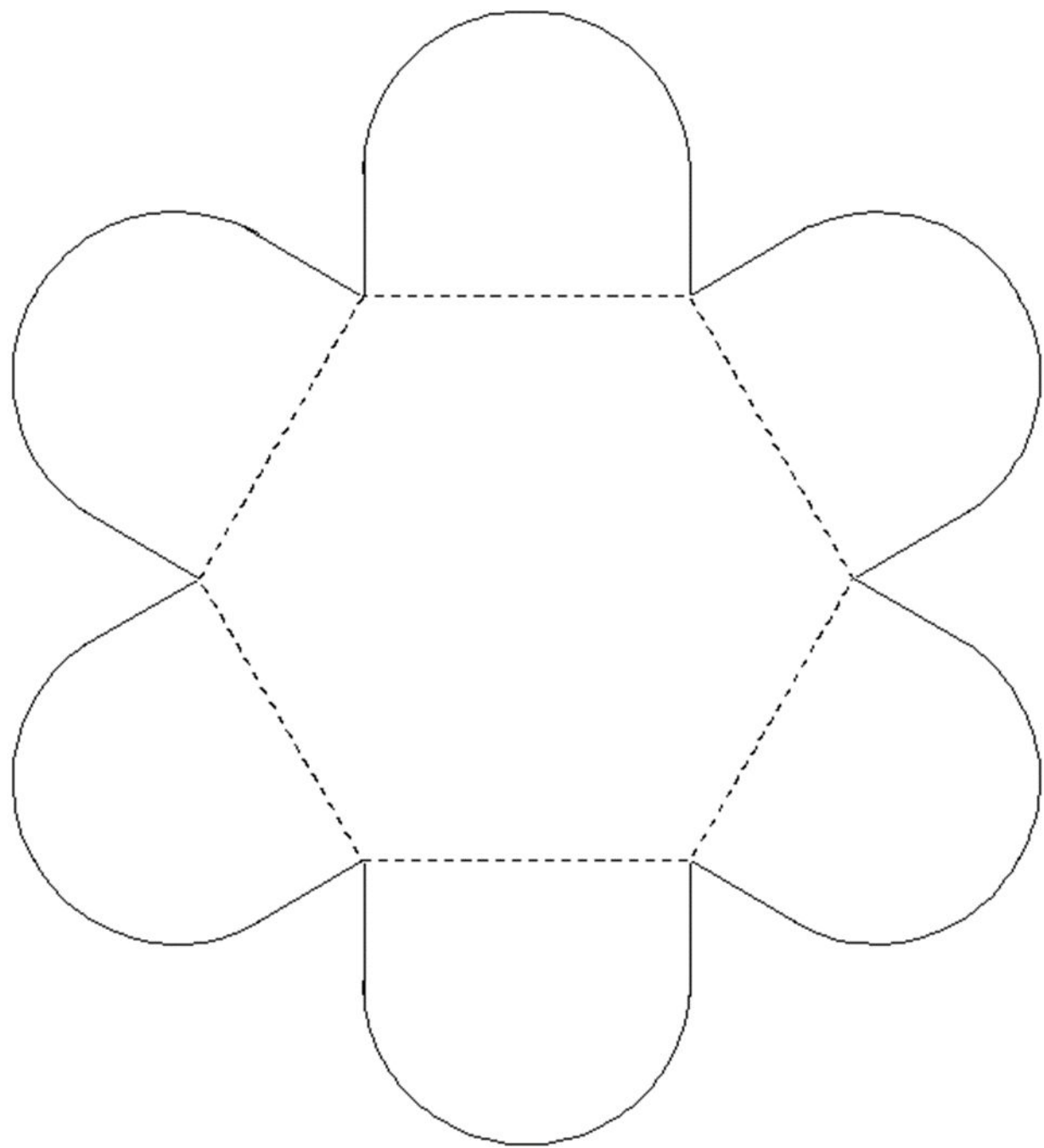

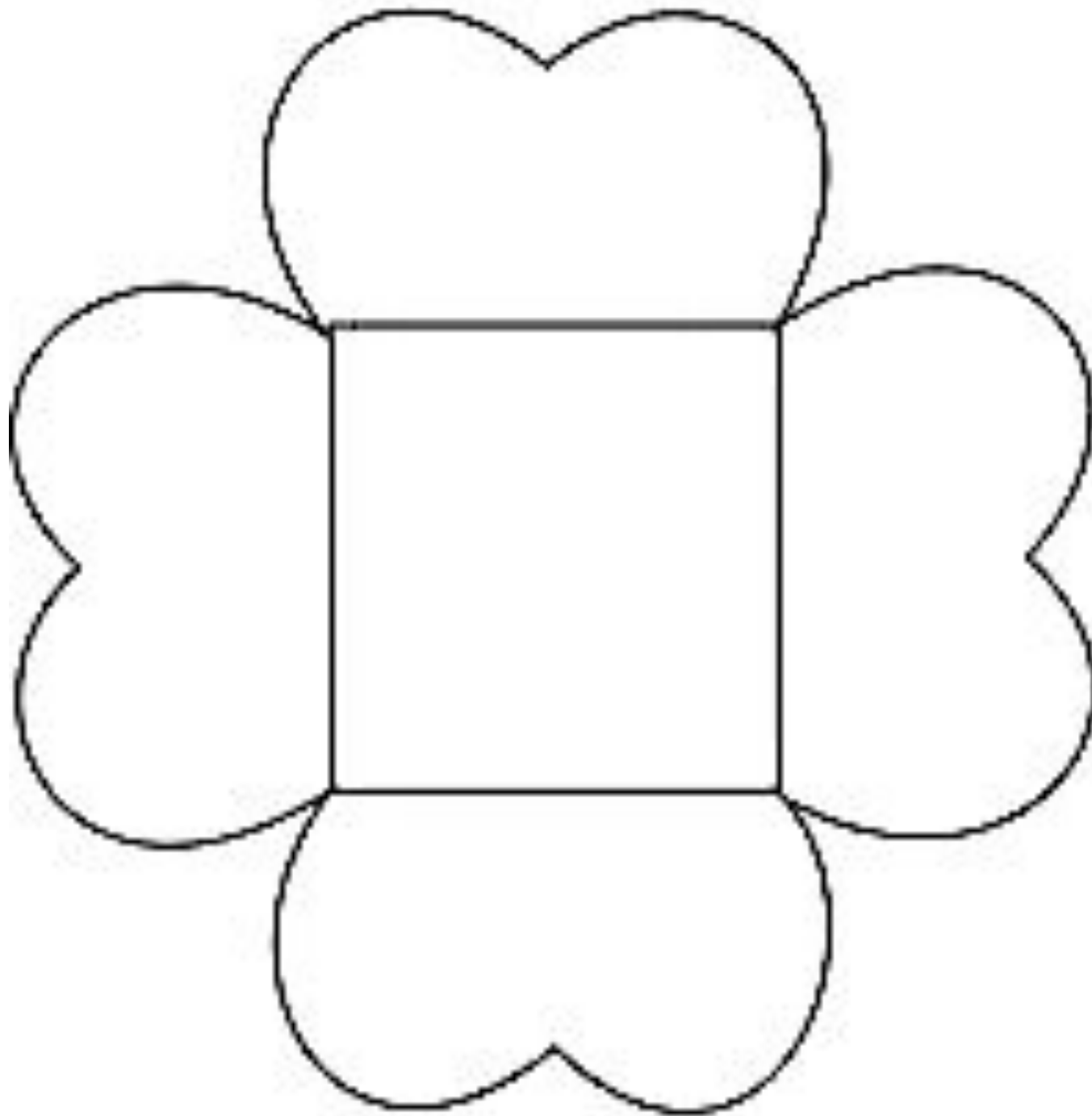

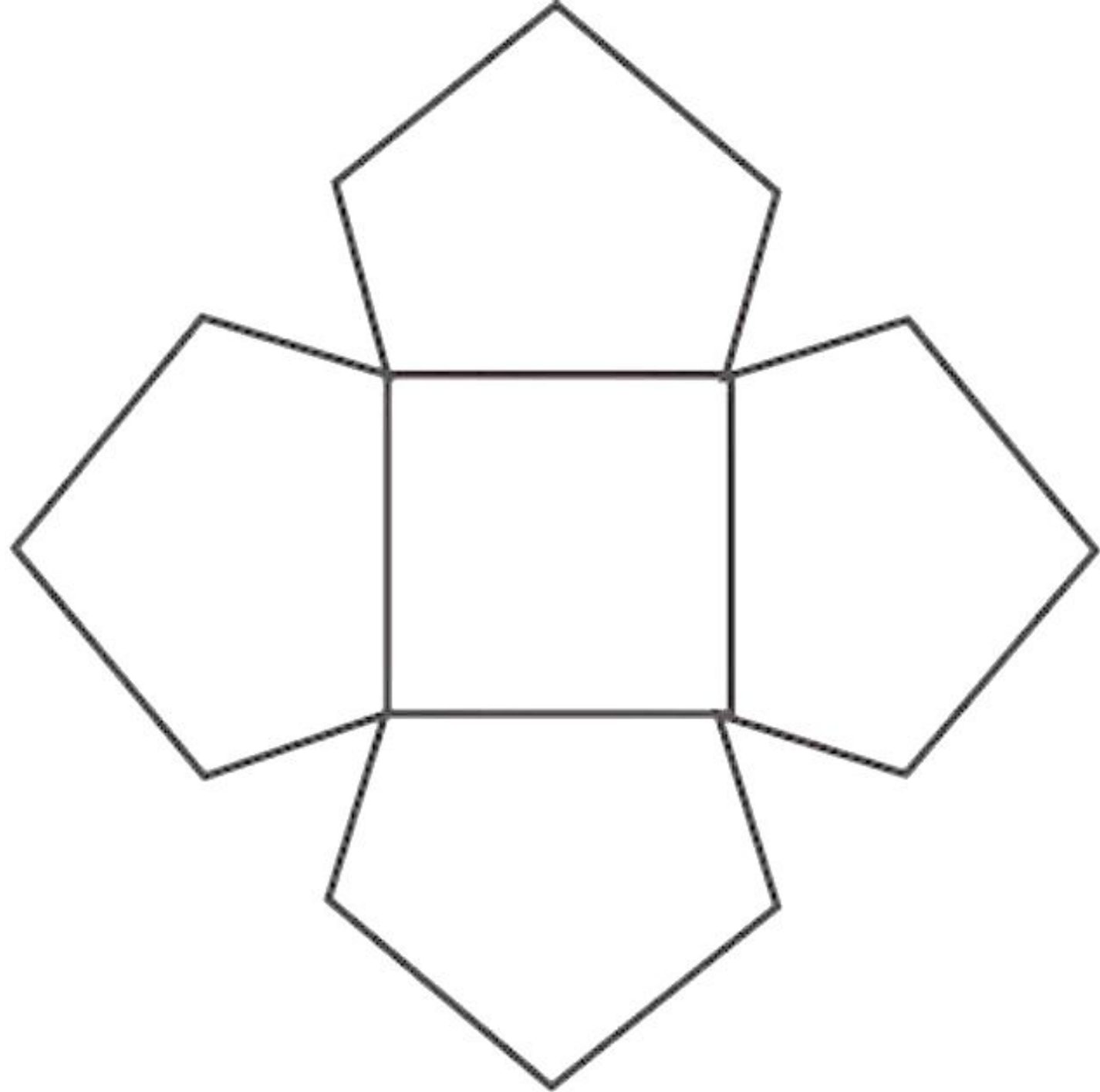

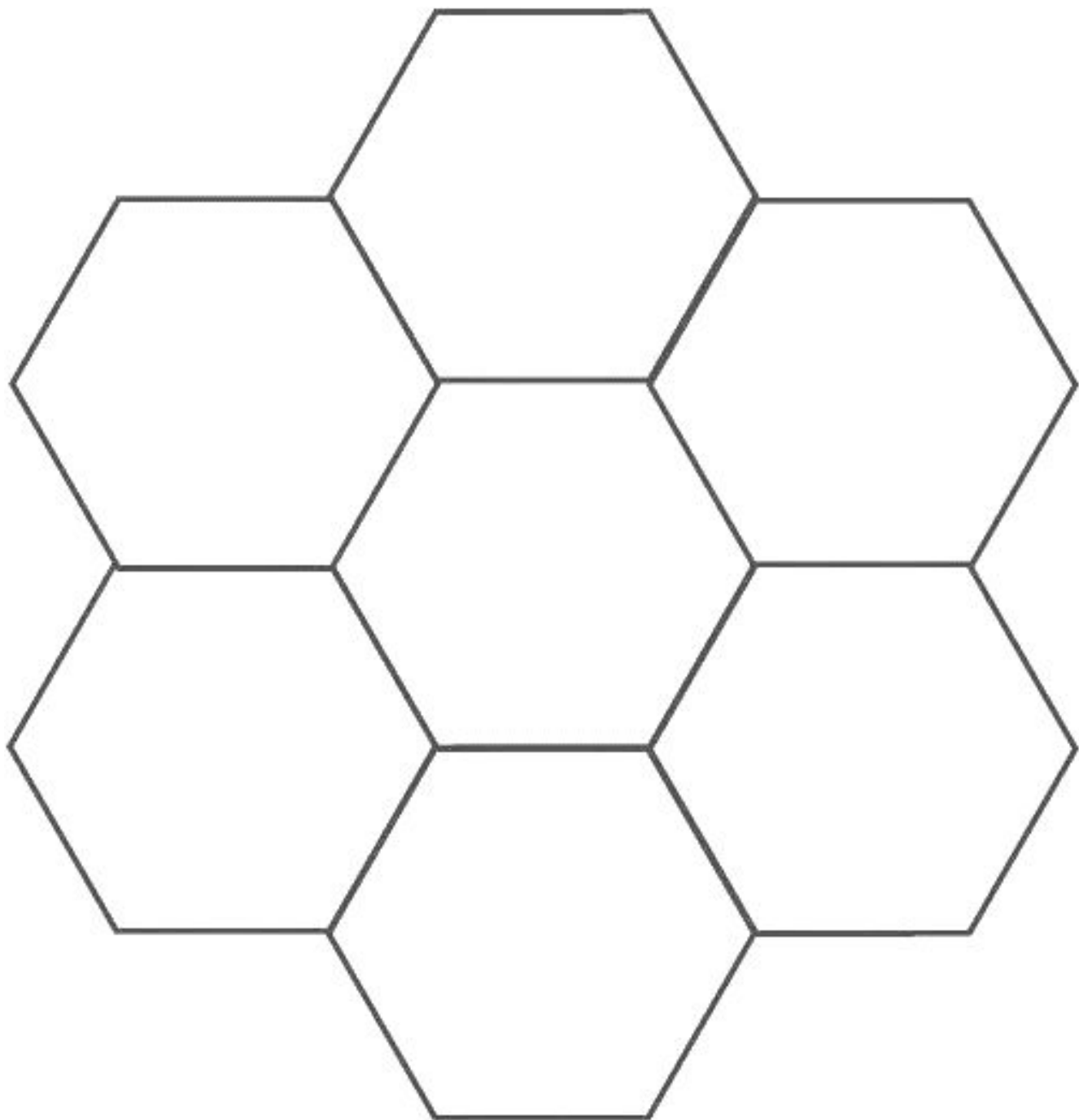

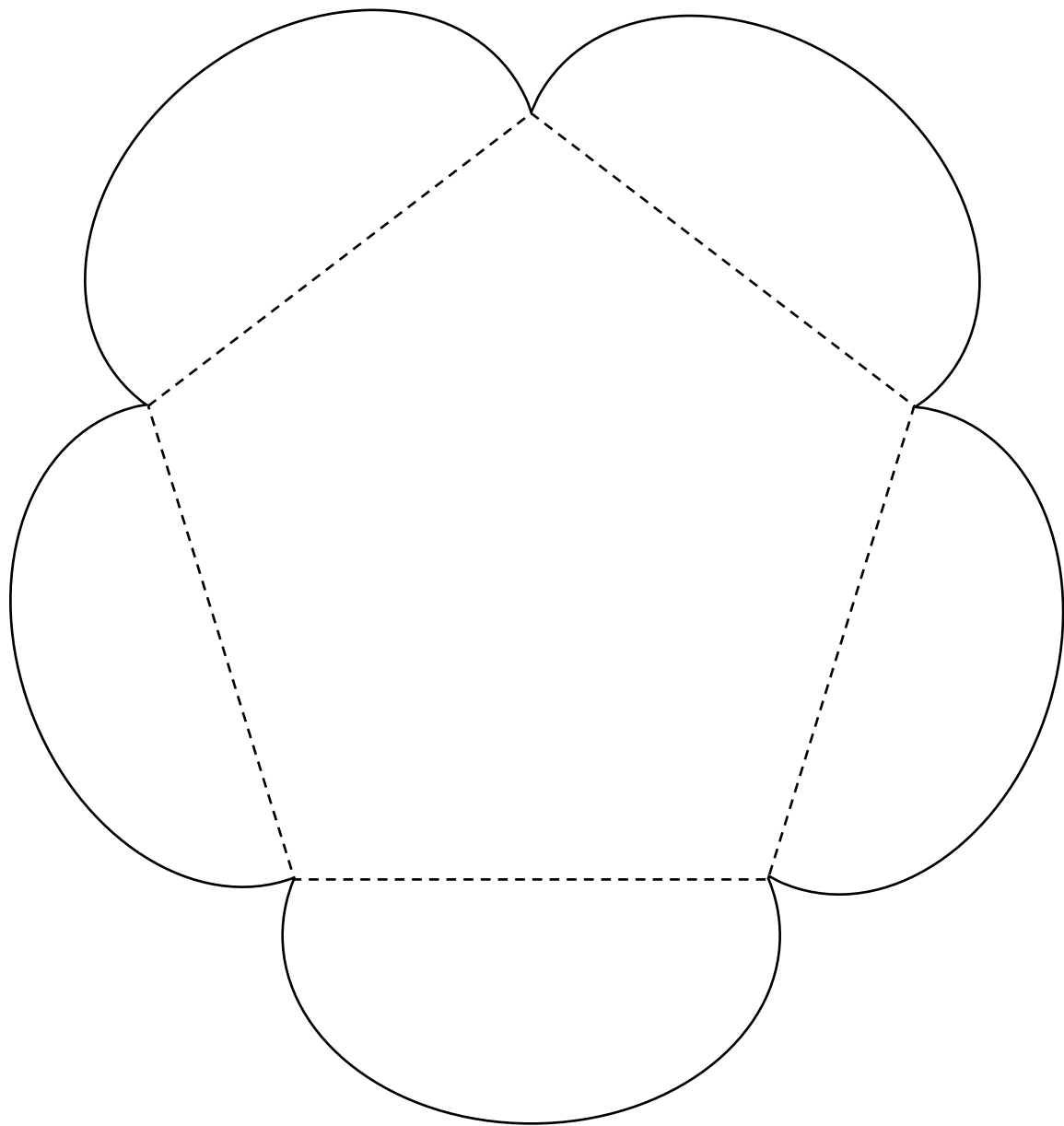

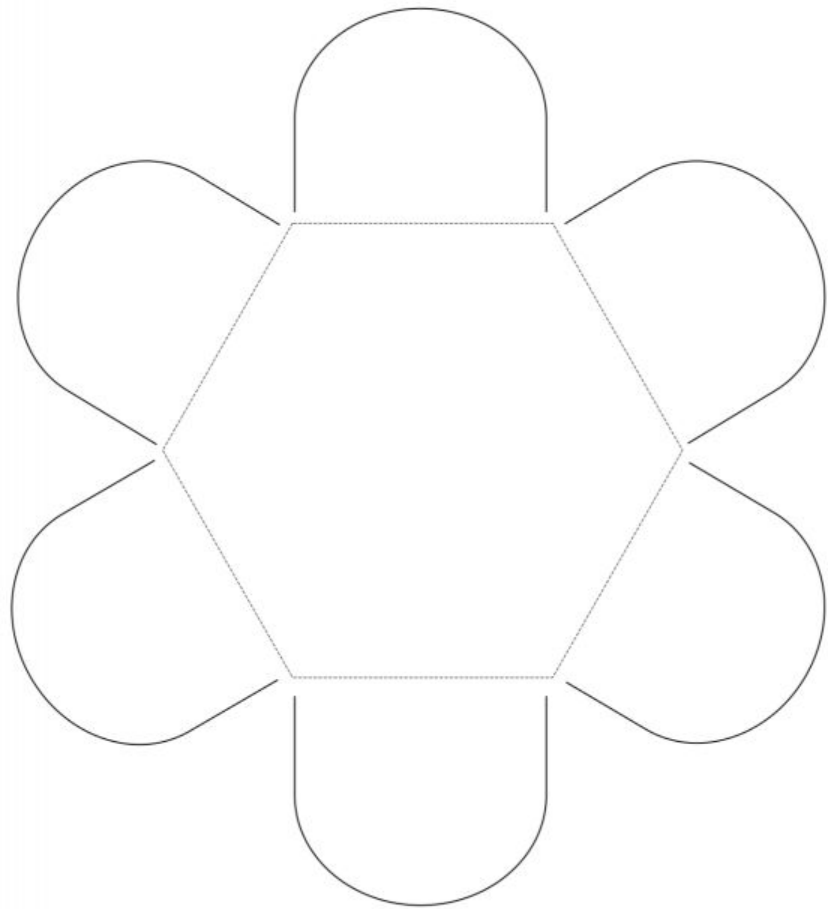
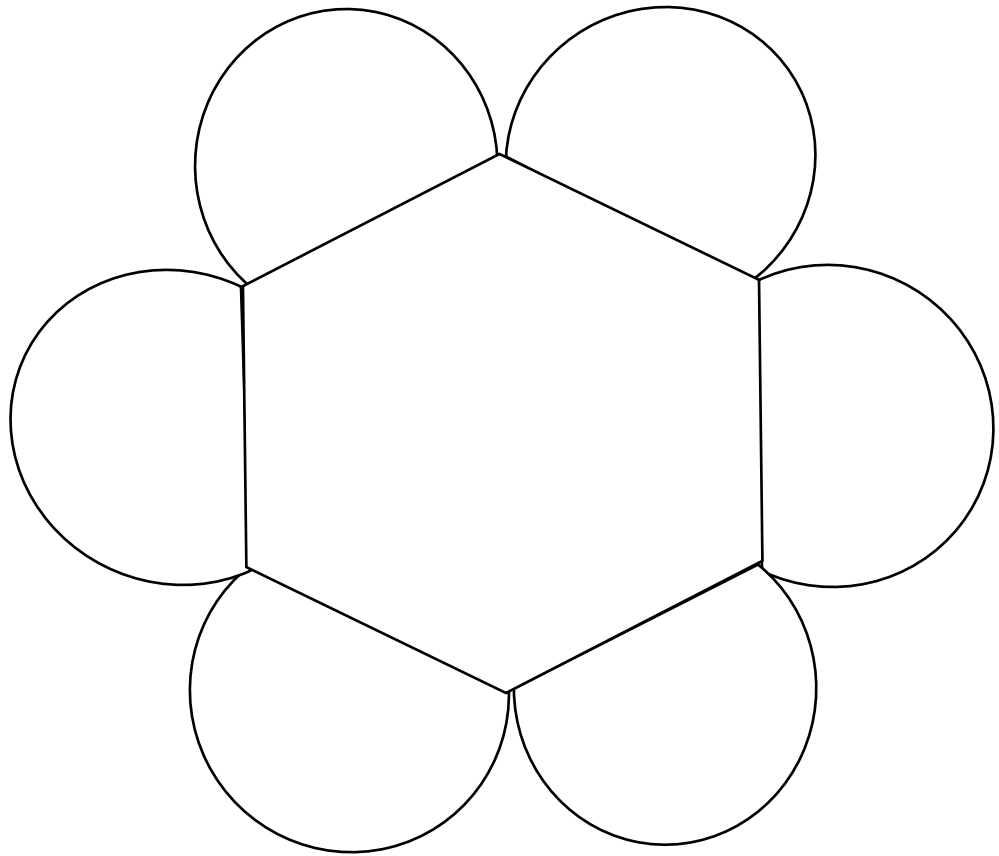

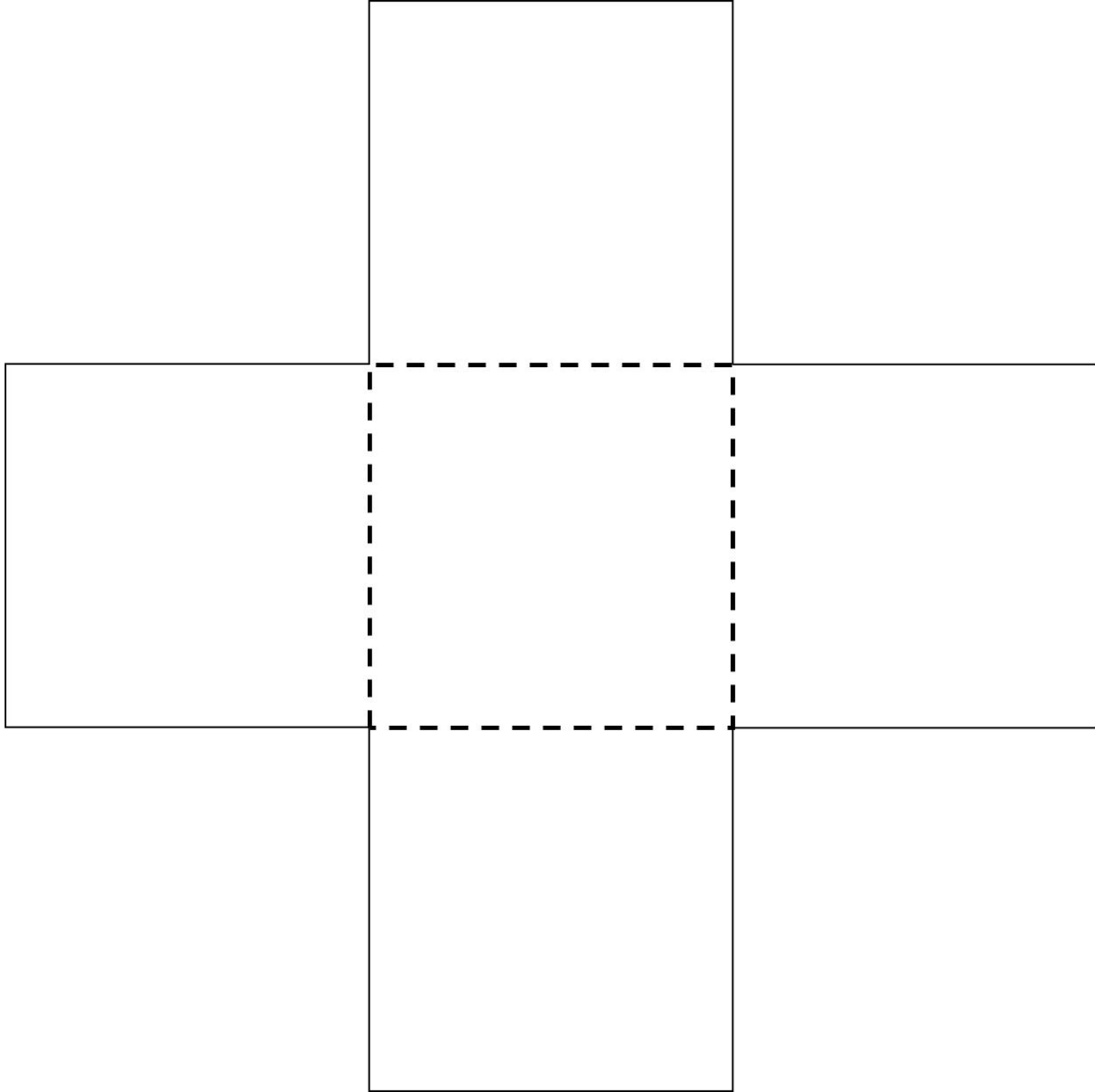

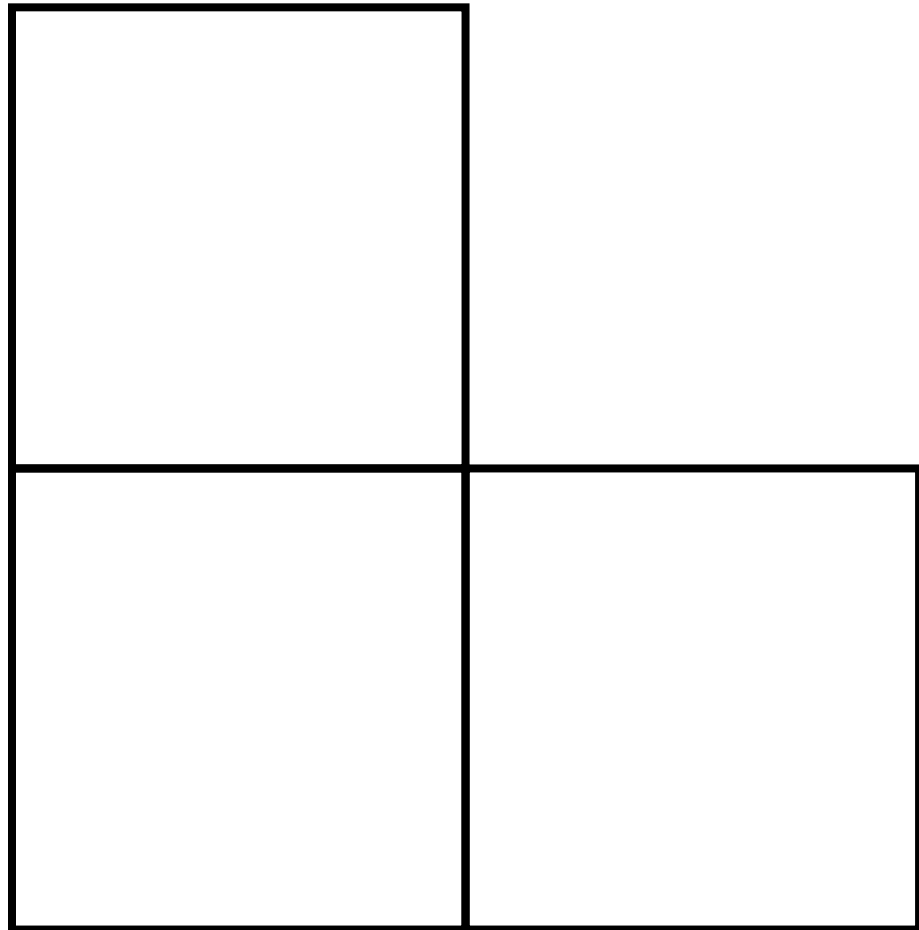
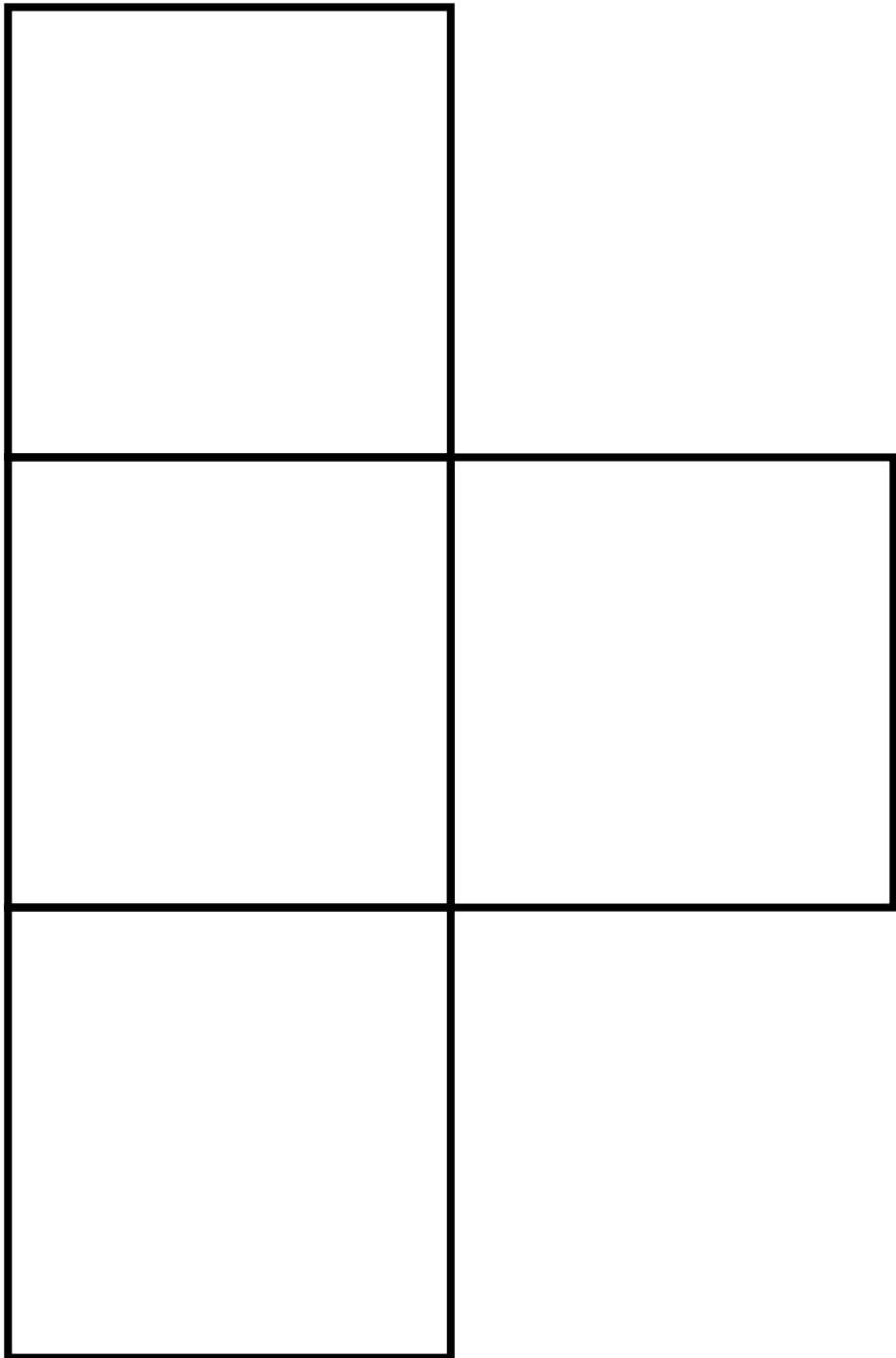

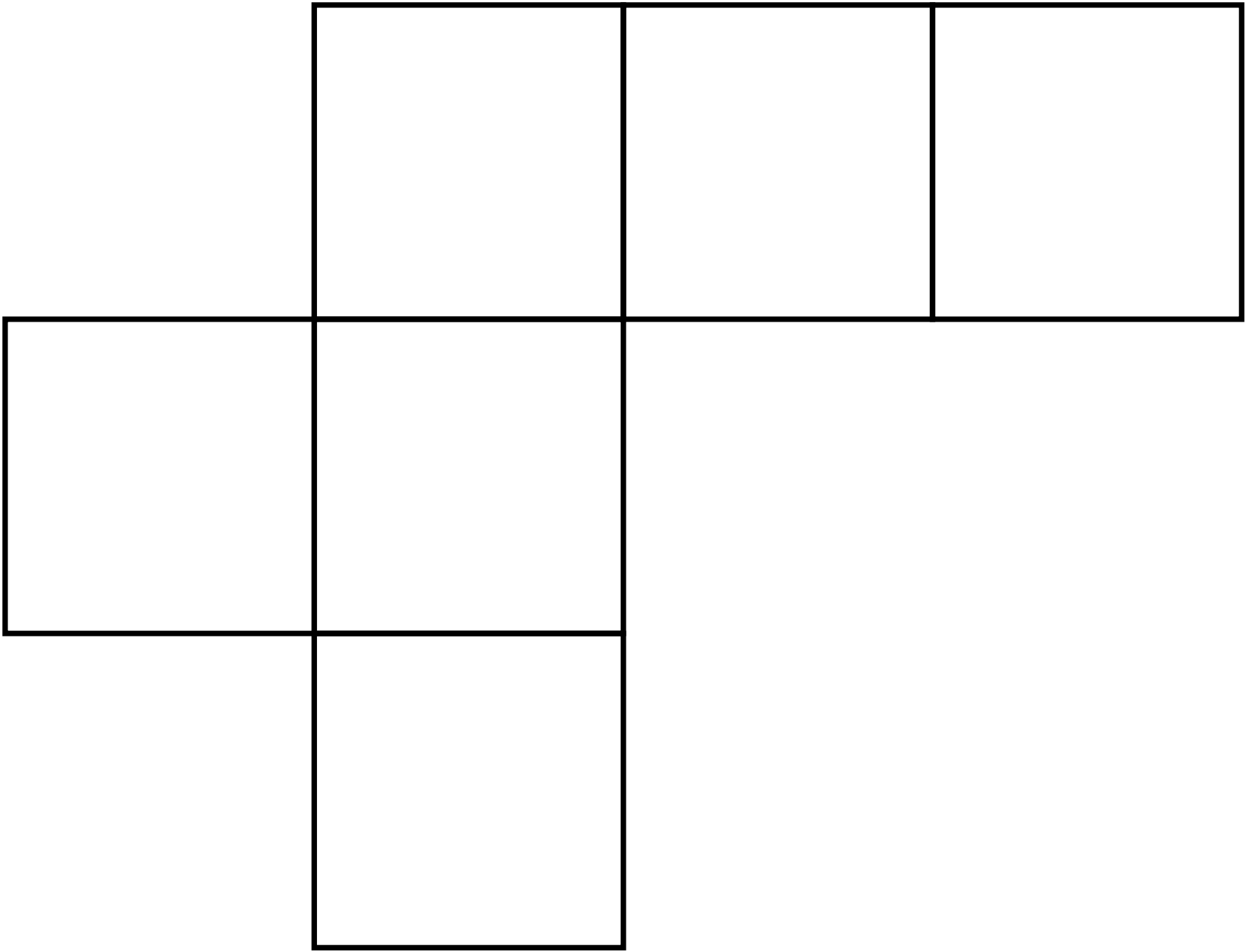

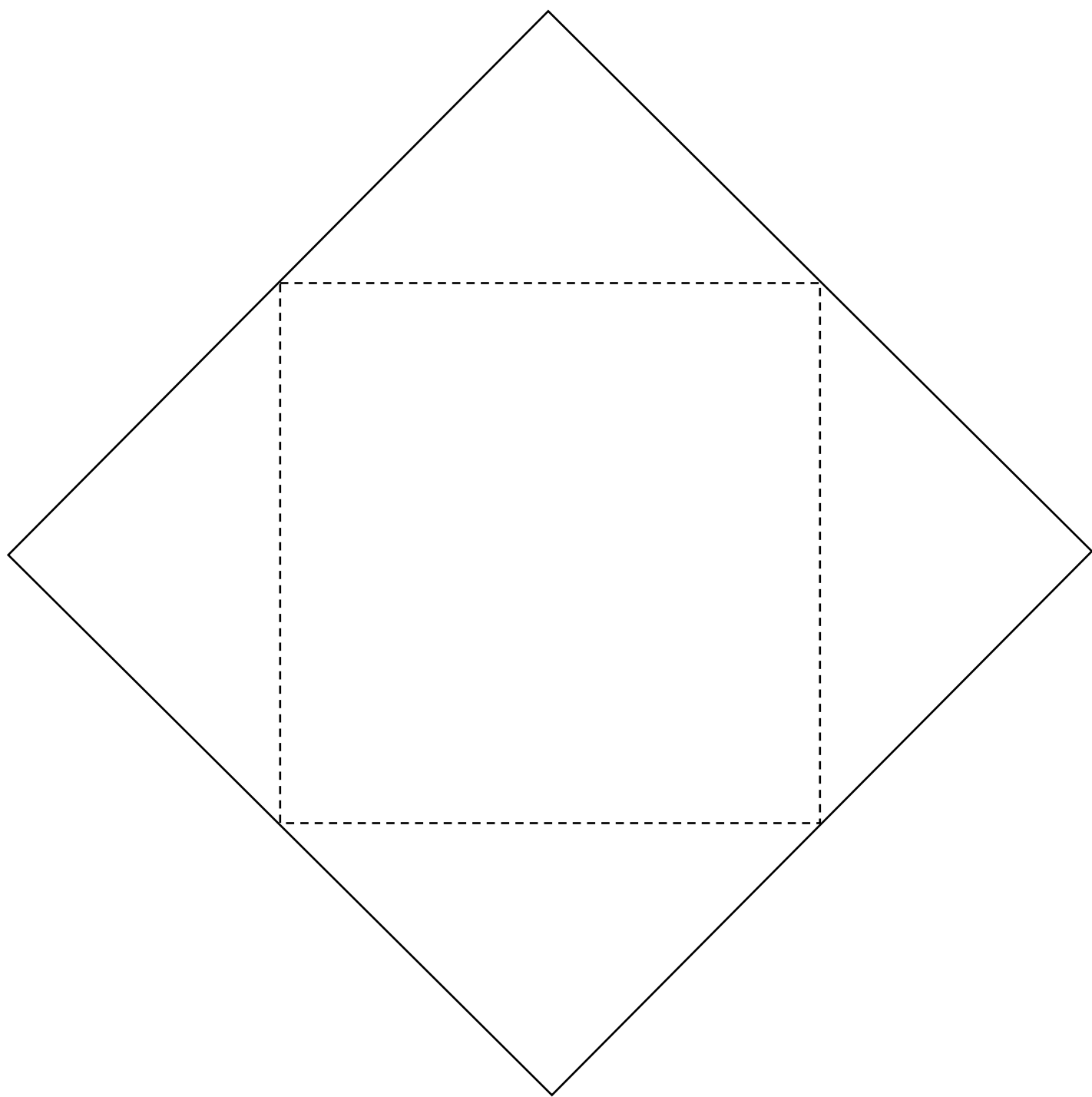

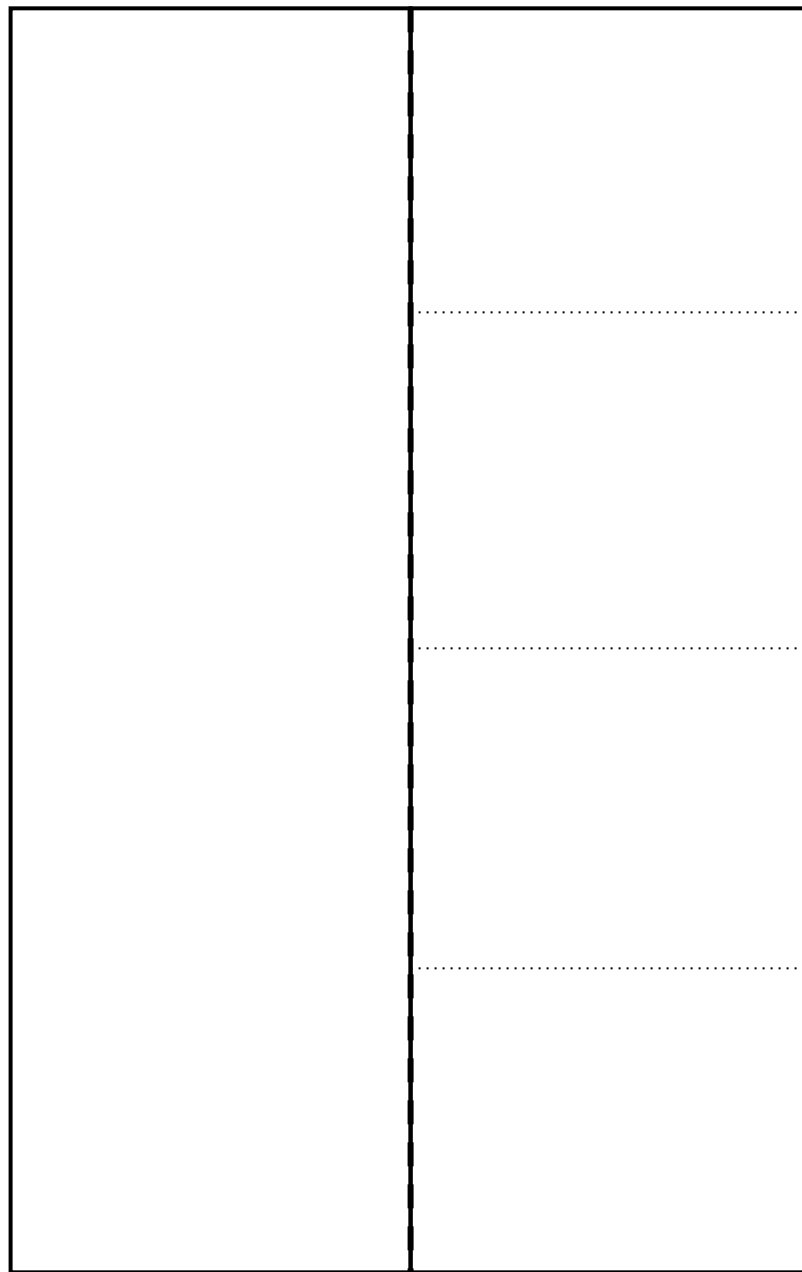
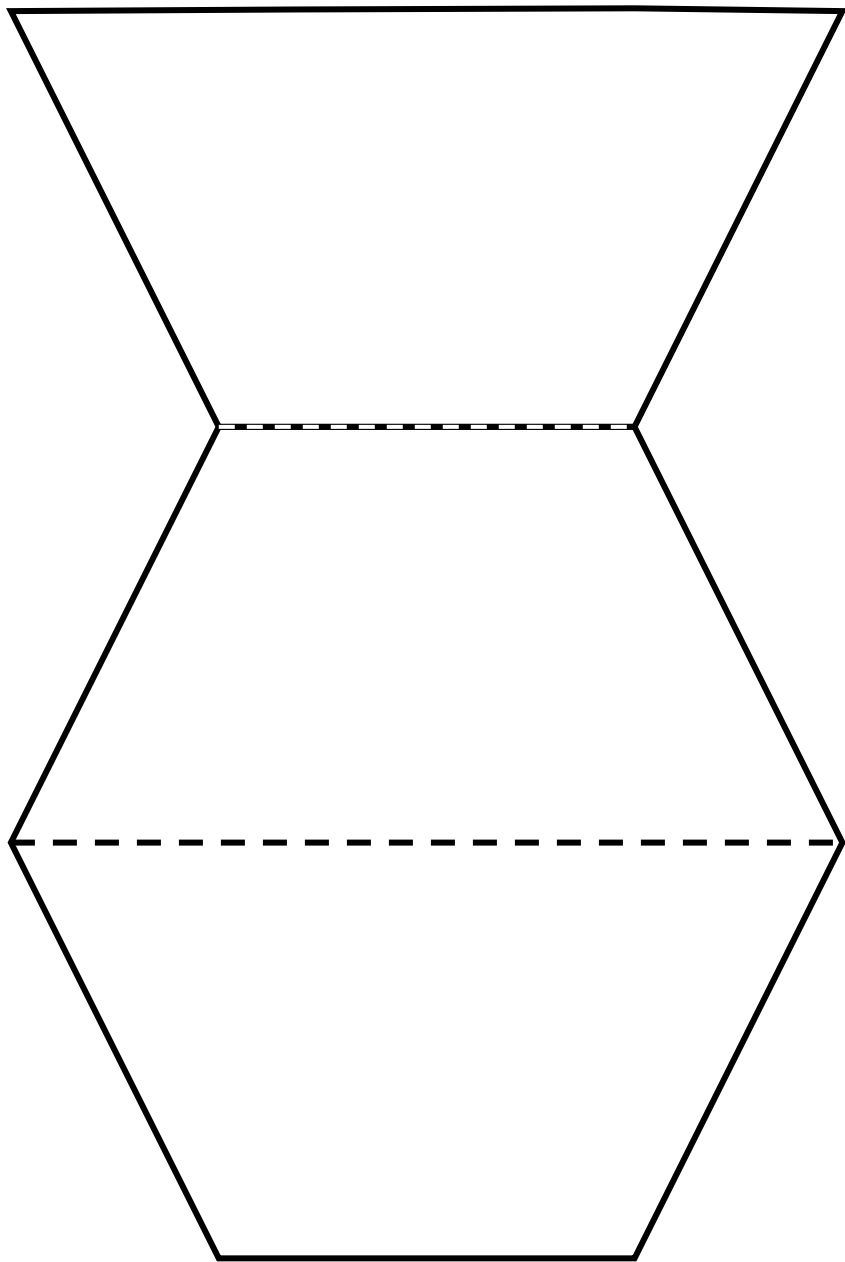

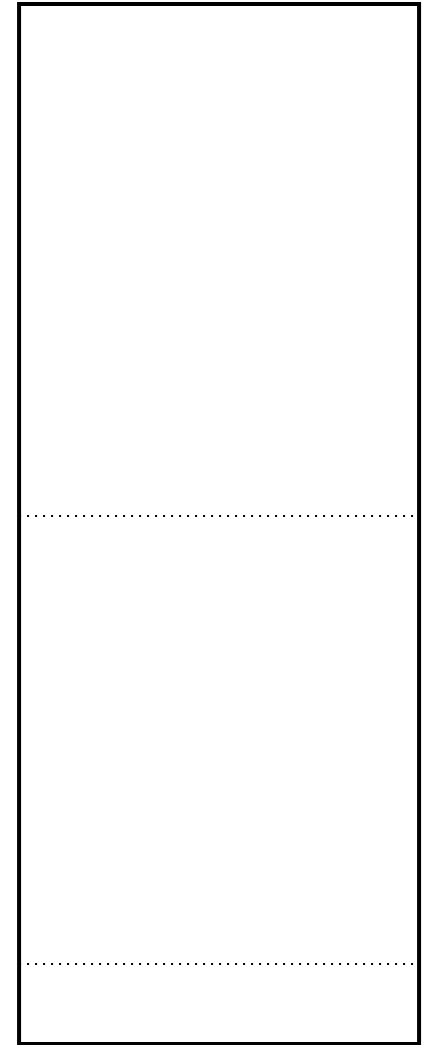
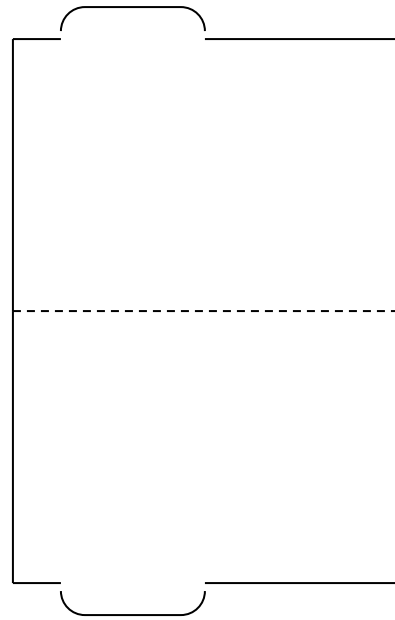
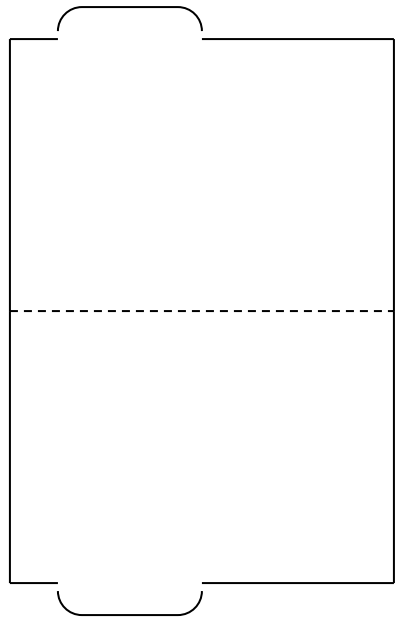
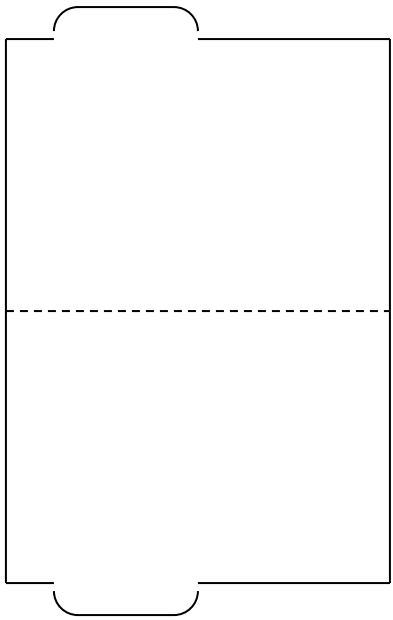
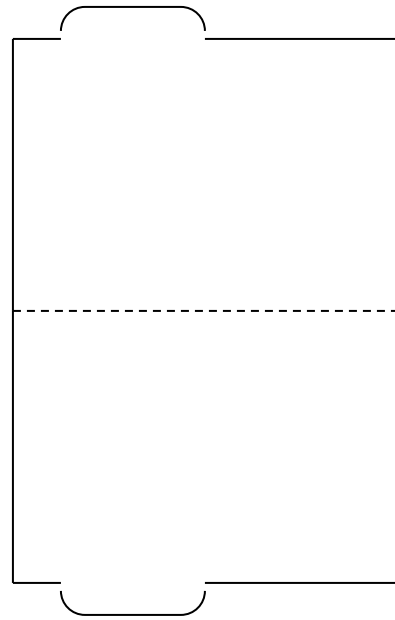
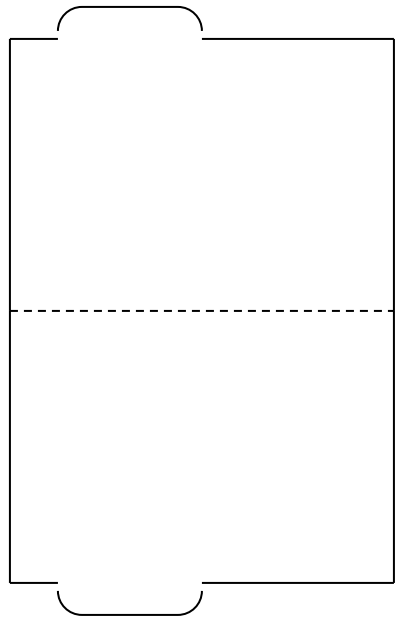
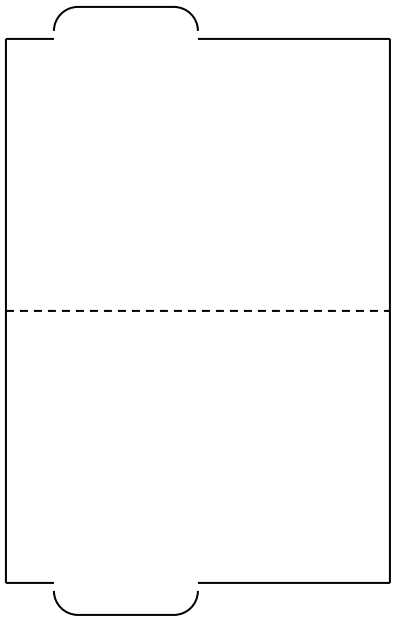

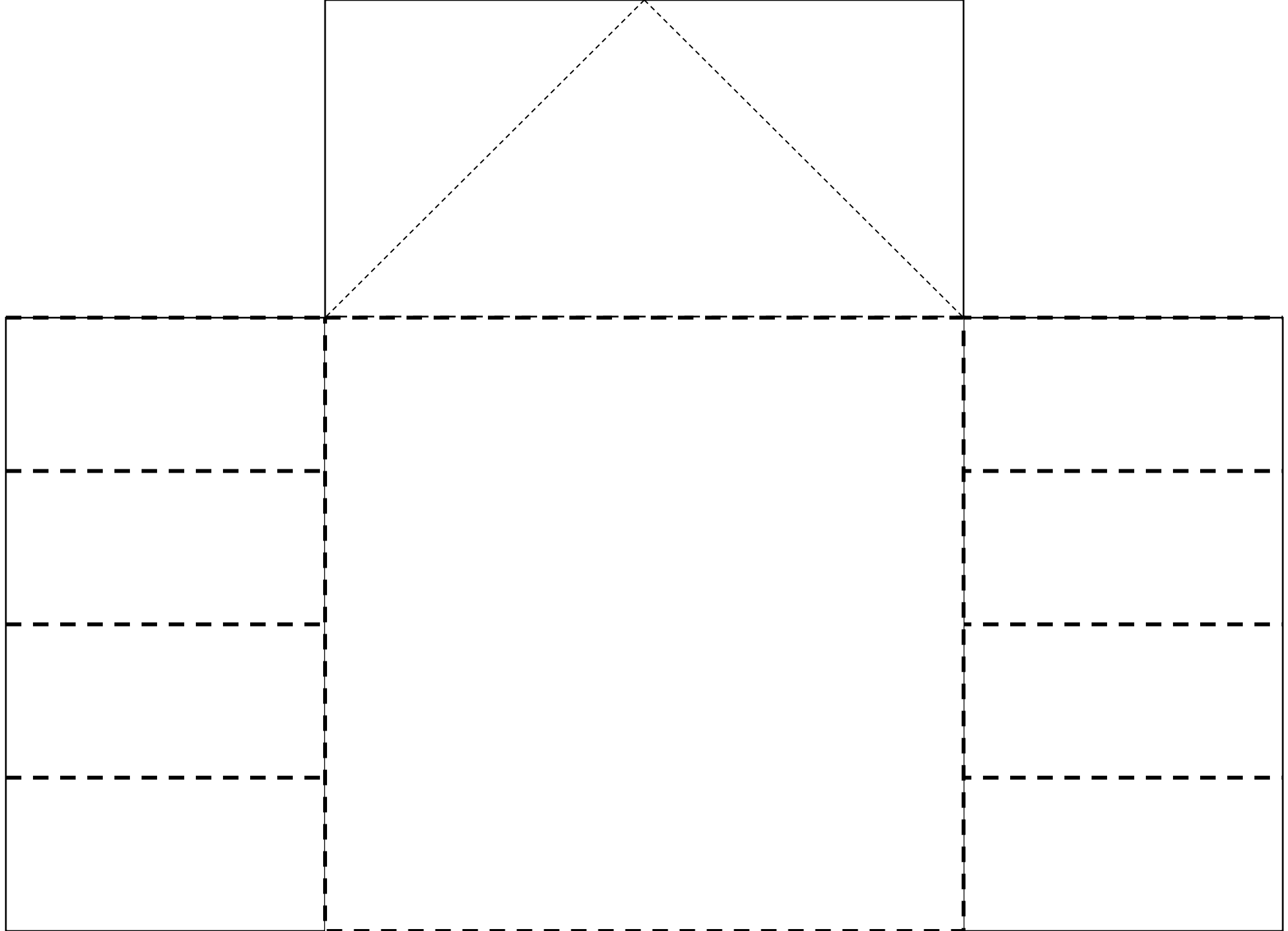

<i>text</i>				
<i>text</i>	<i>text</i>	<i>text</i>	<i>text</i>	<i>text</i>

Stretch a sentence				
who?	doing what?	when?	where?	why?

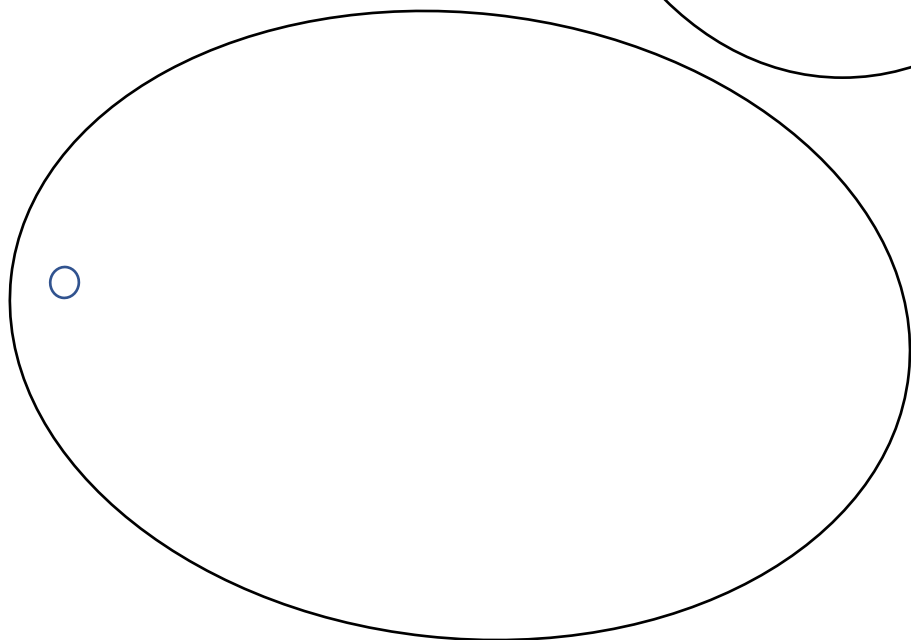
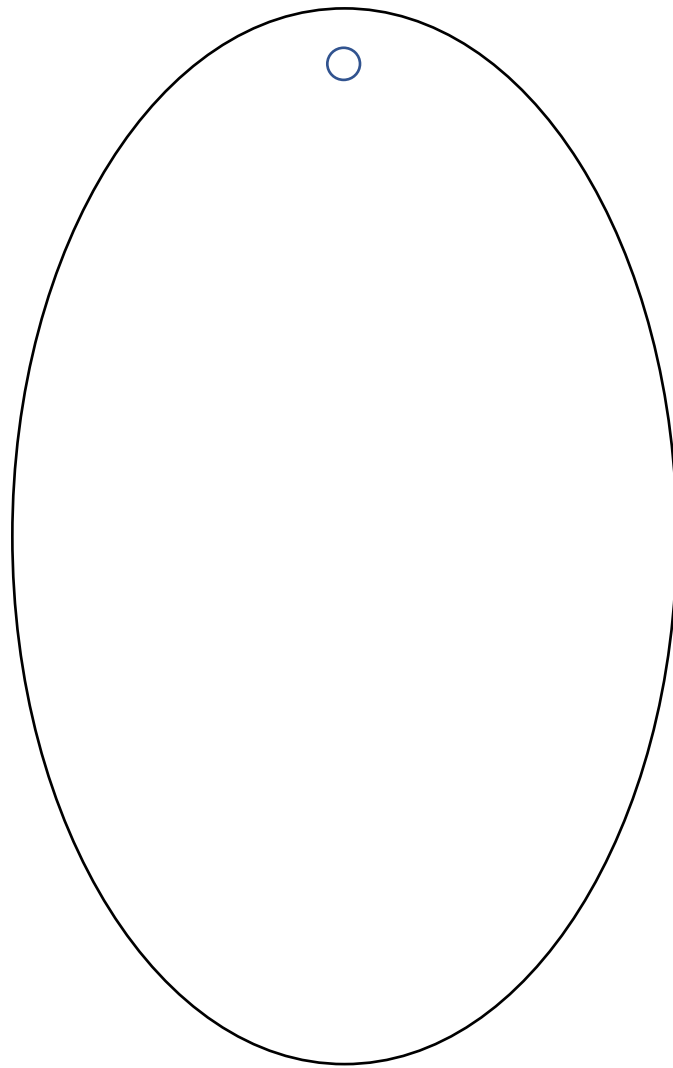
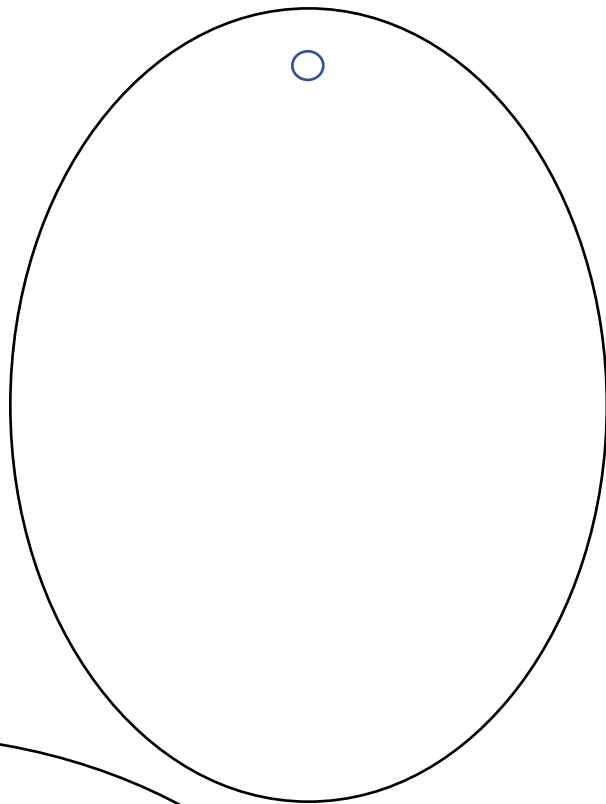
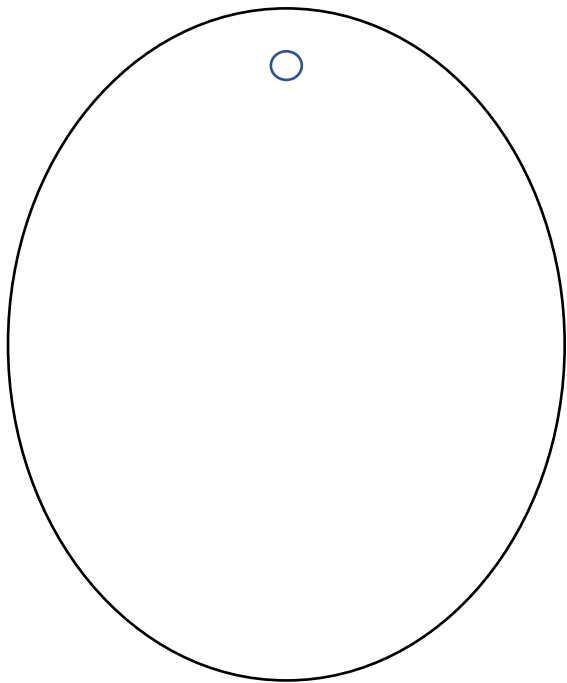

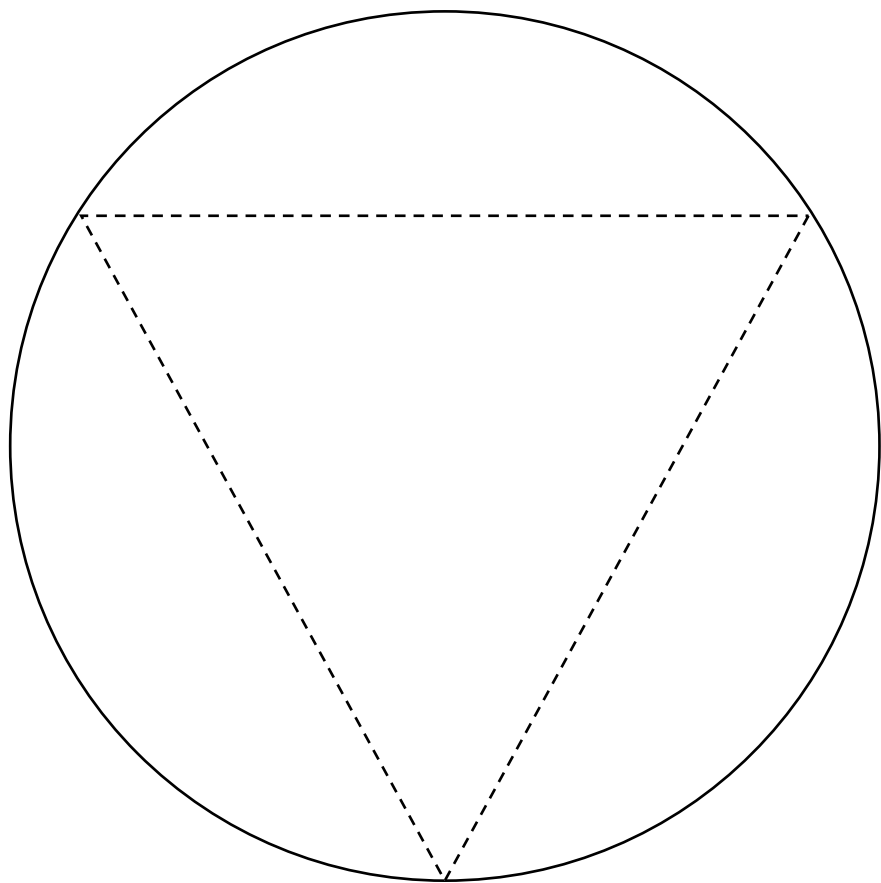

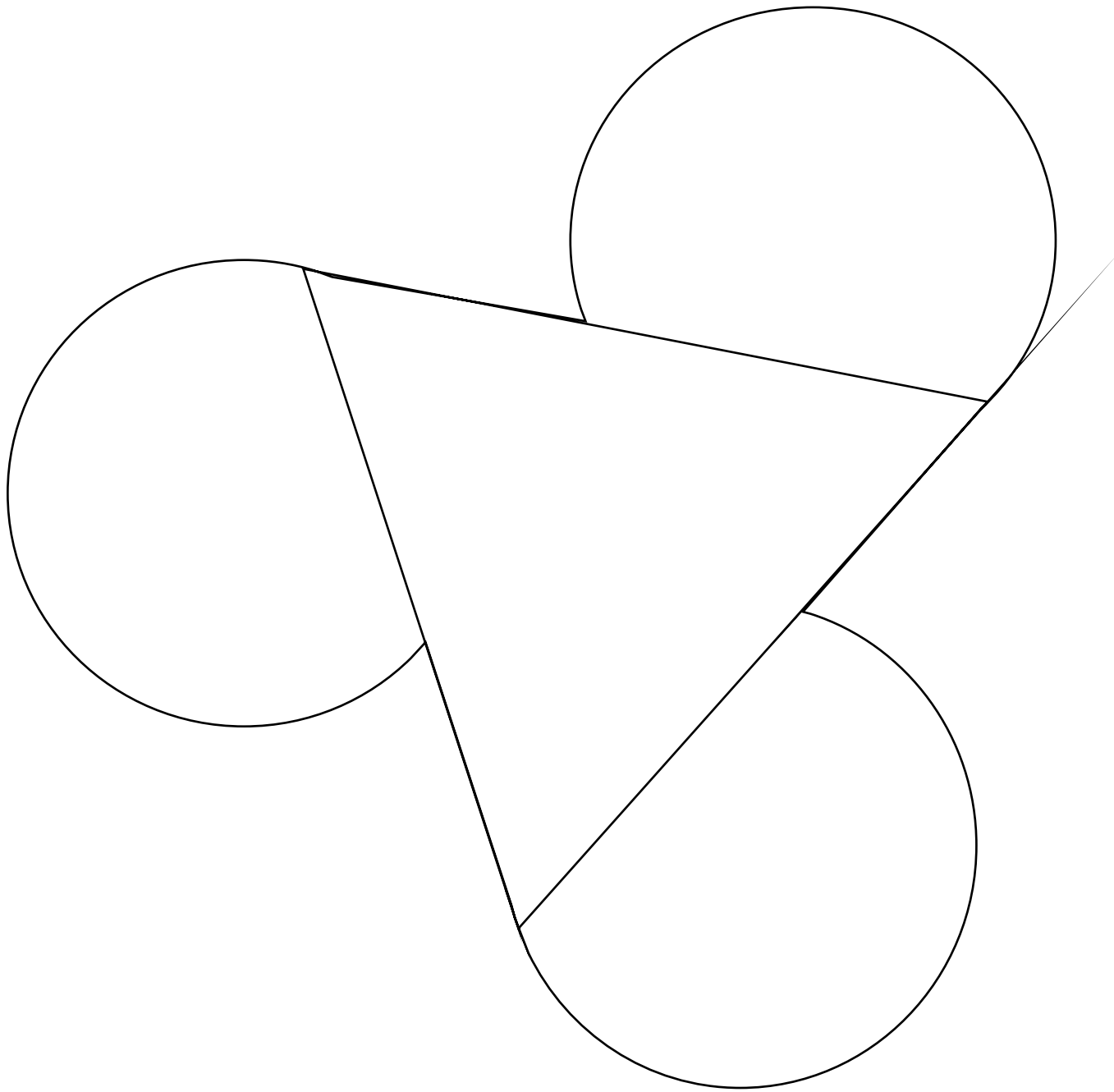

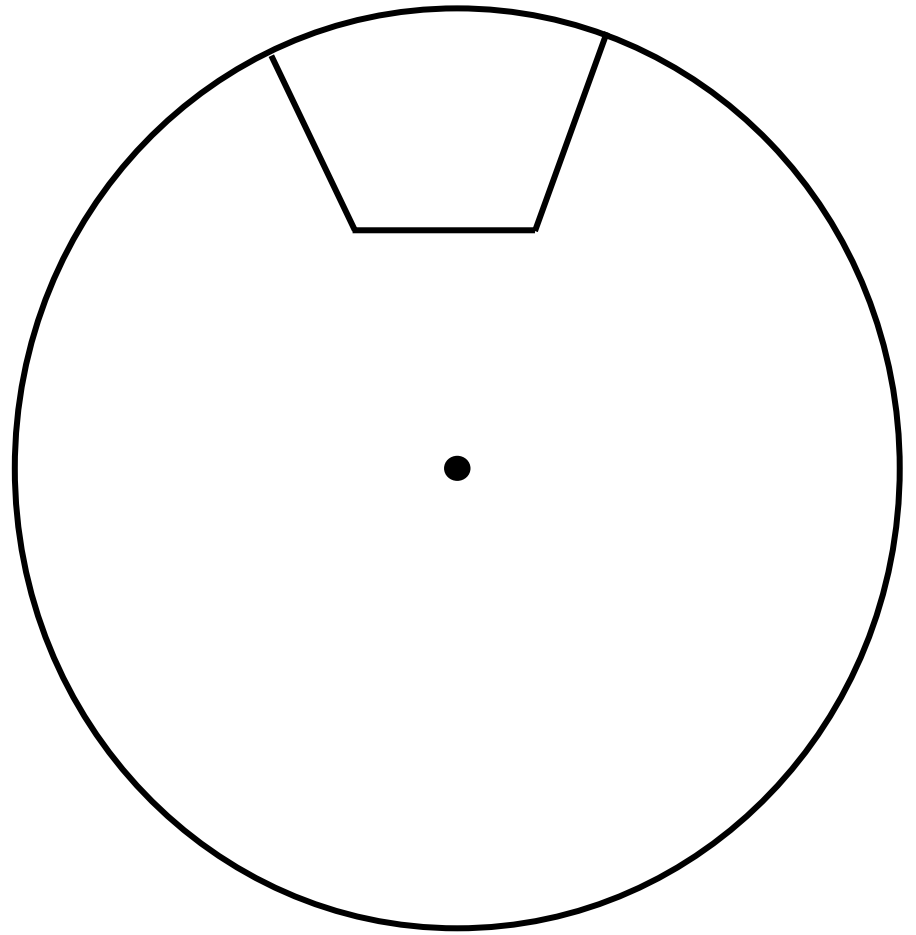
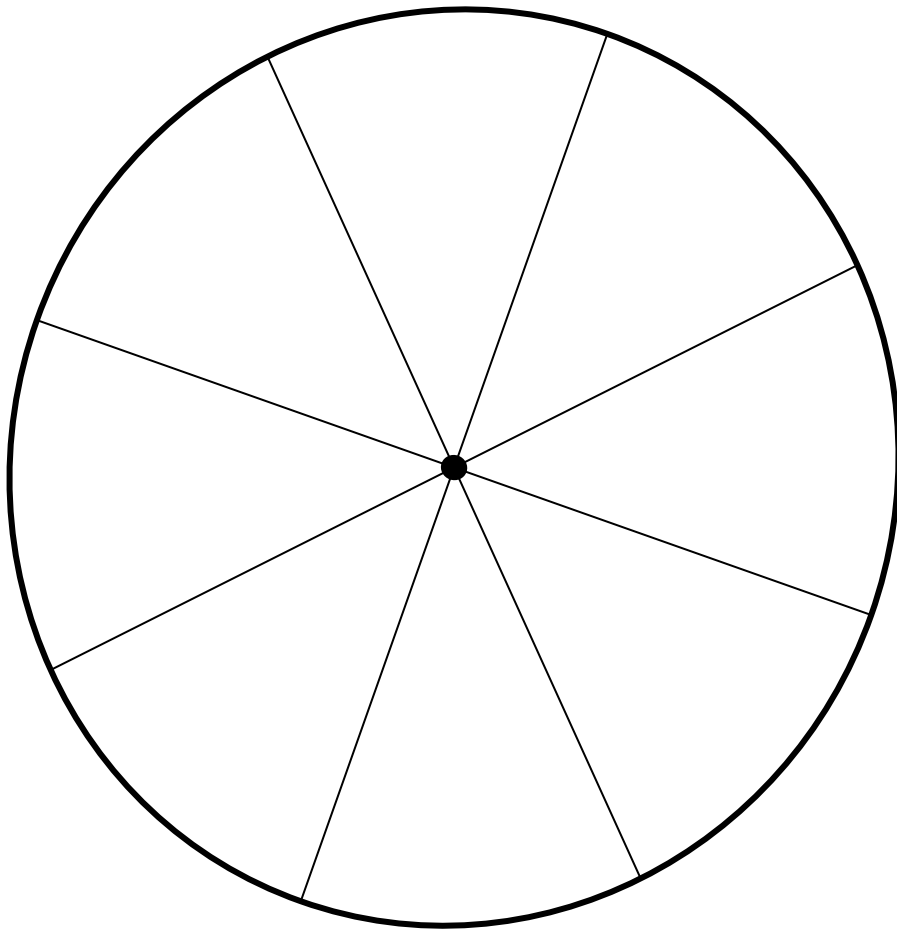

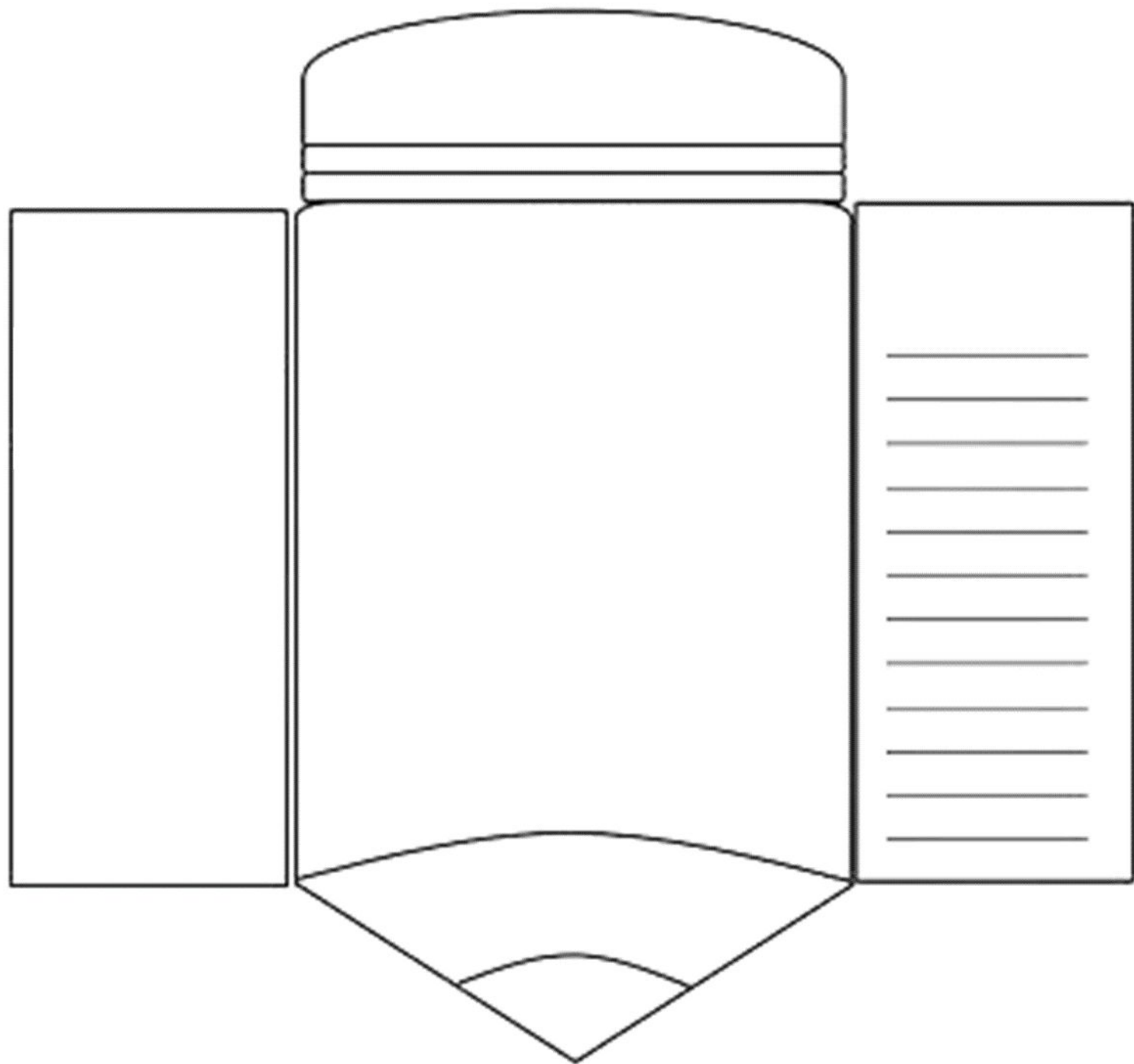

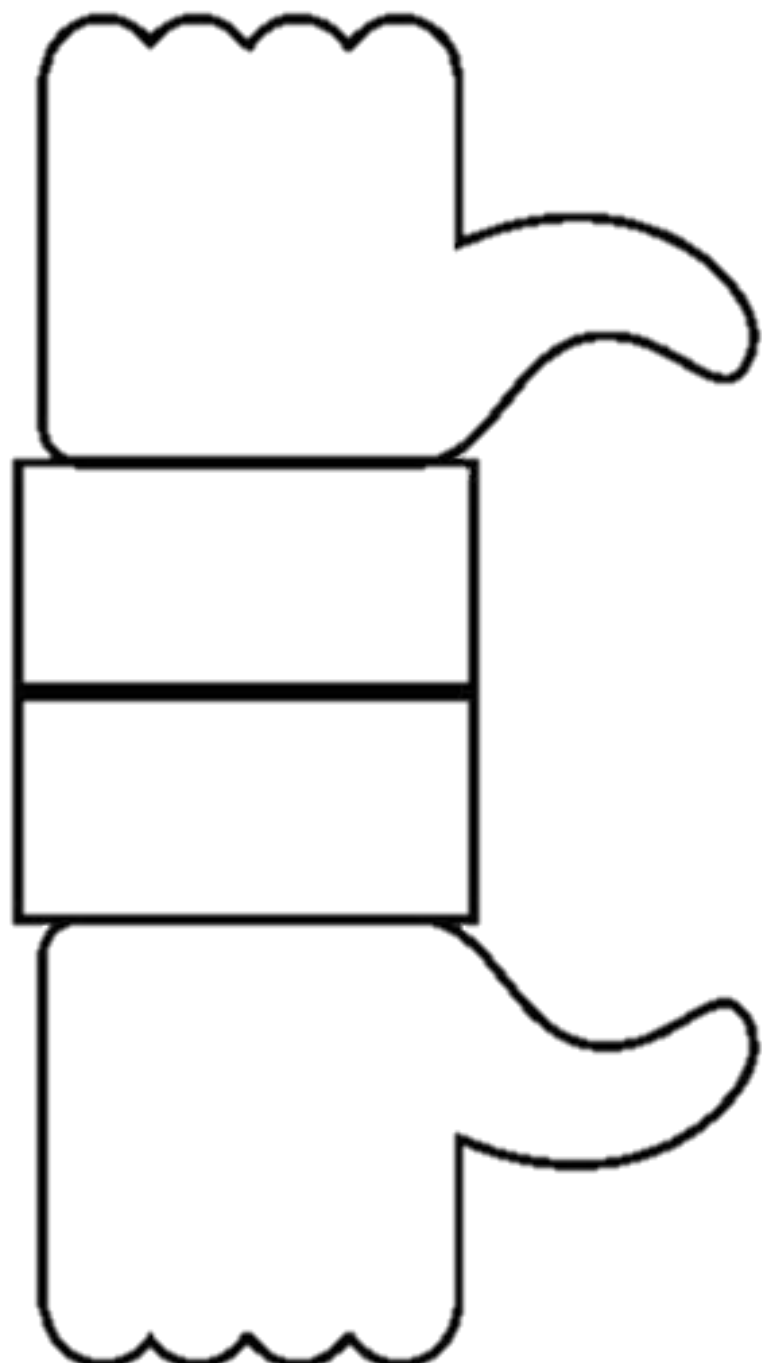

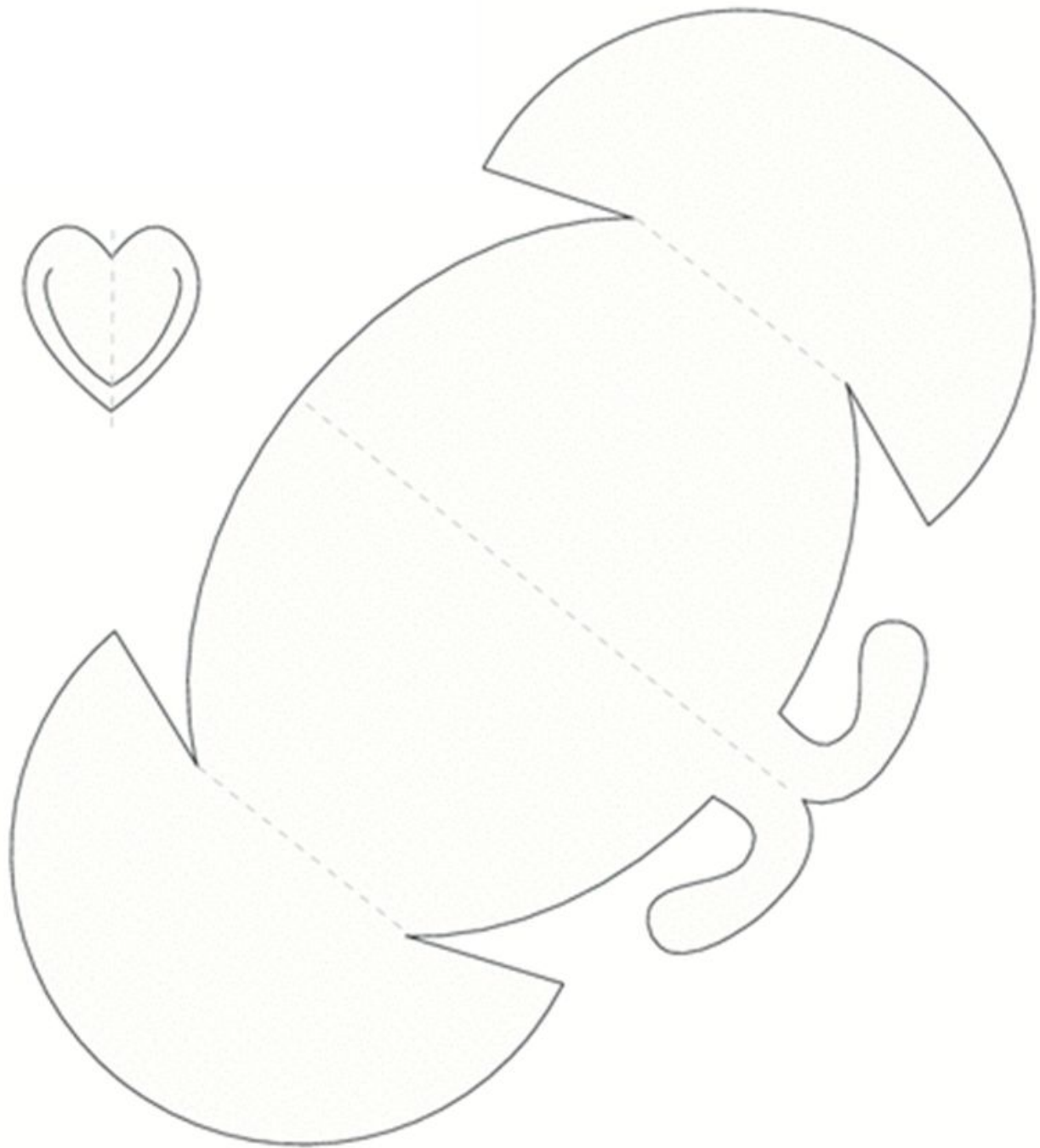

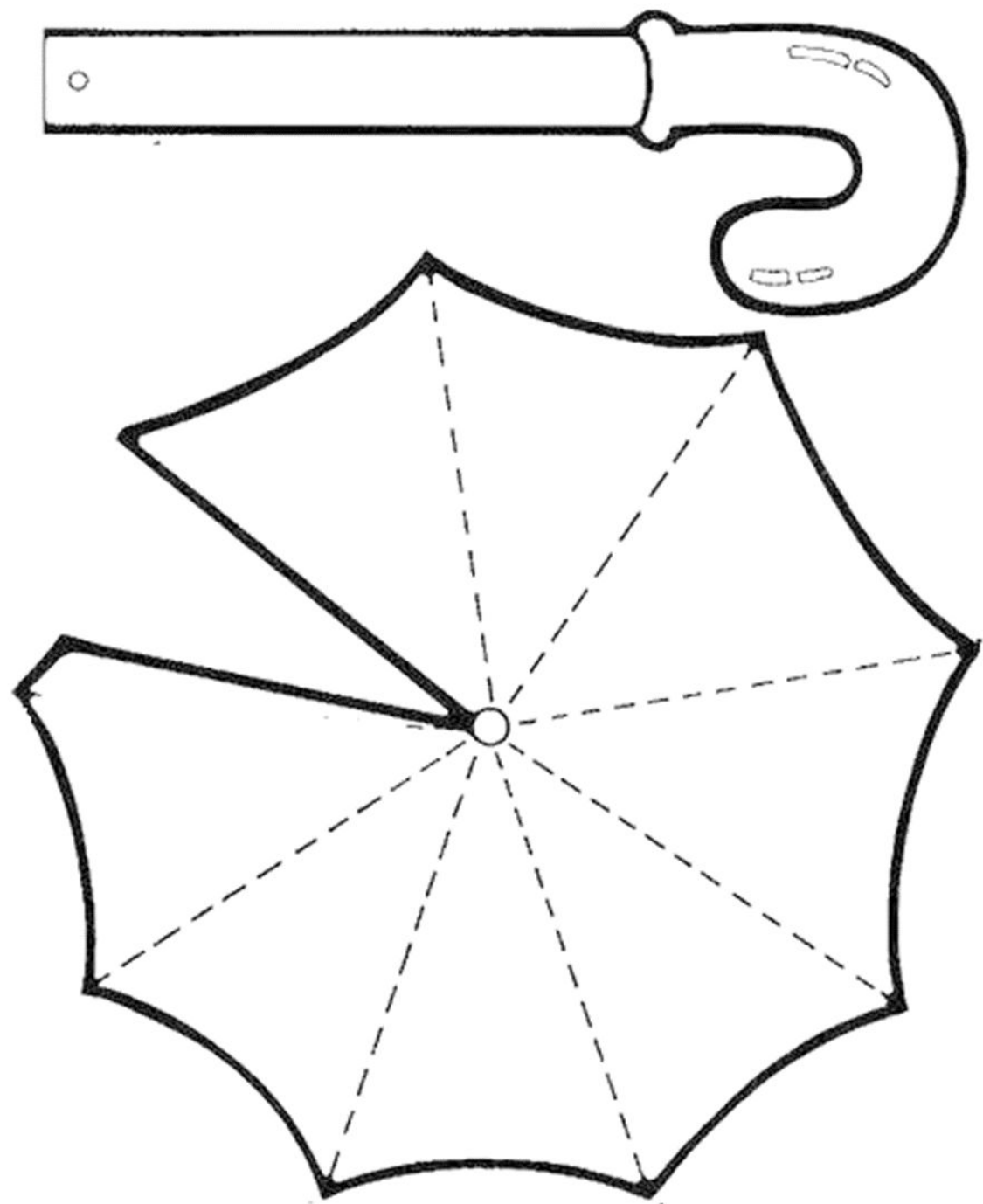

SPHERICON

1. Cut along solid lines
2. Tent fold all dotted lines
3. Glue tab "A" under edge "B"
4. Glue or tape curved edges

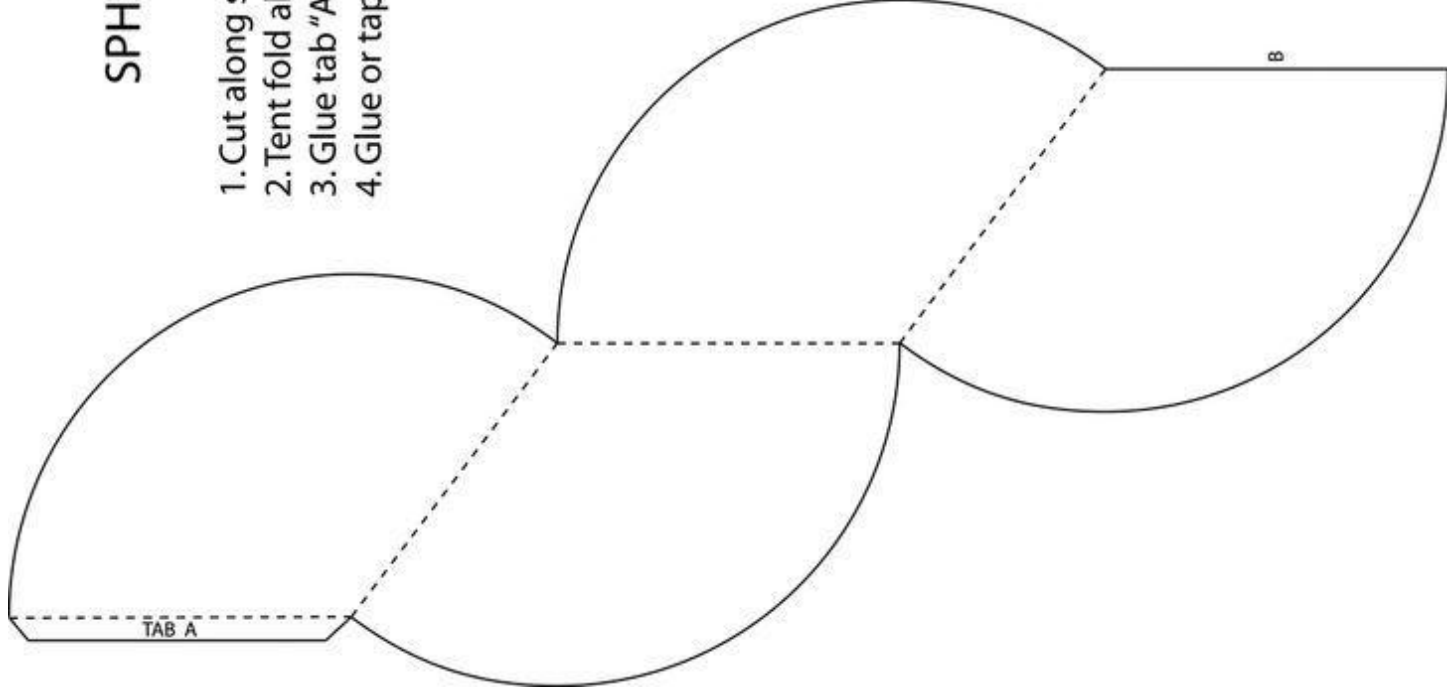

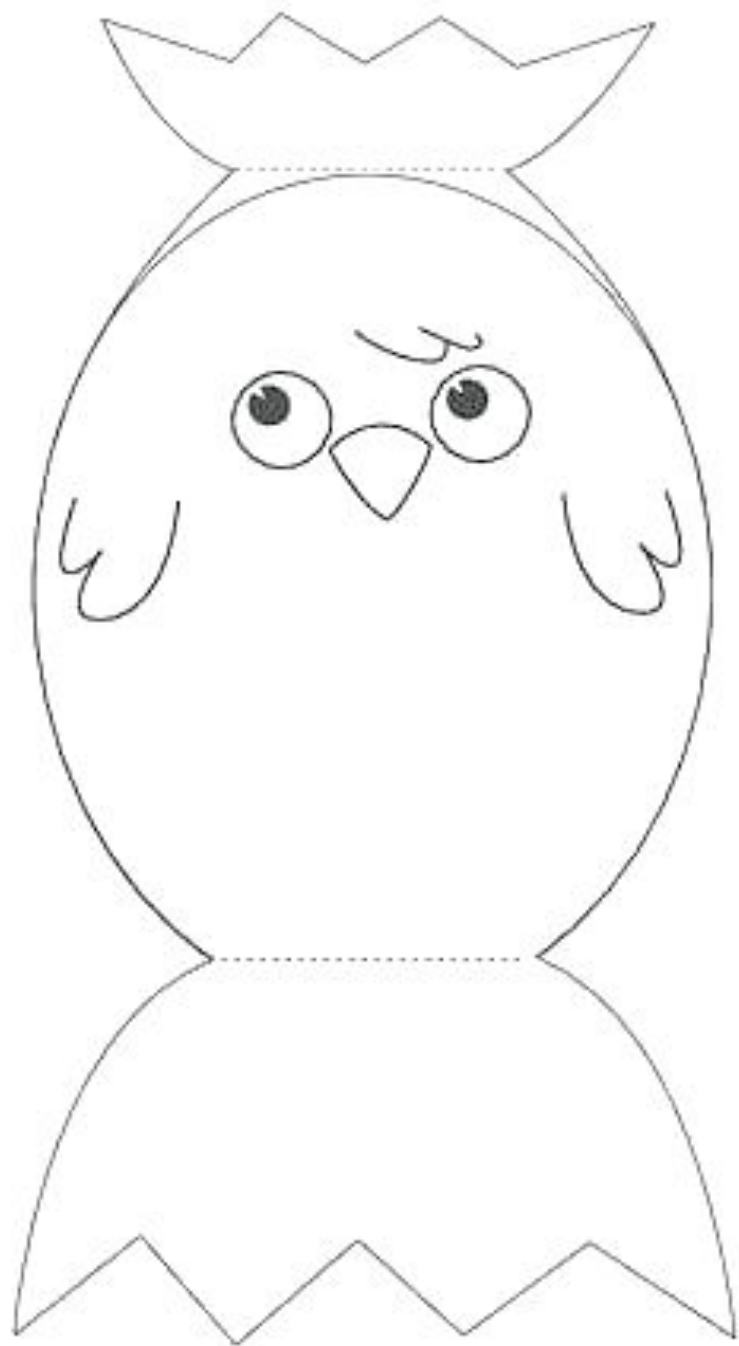

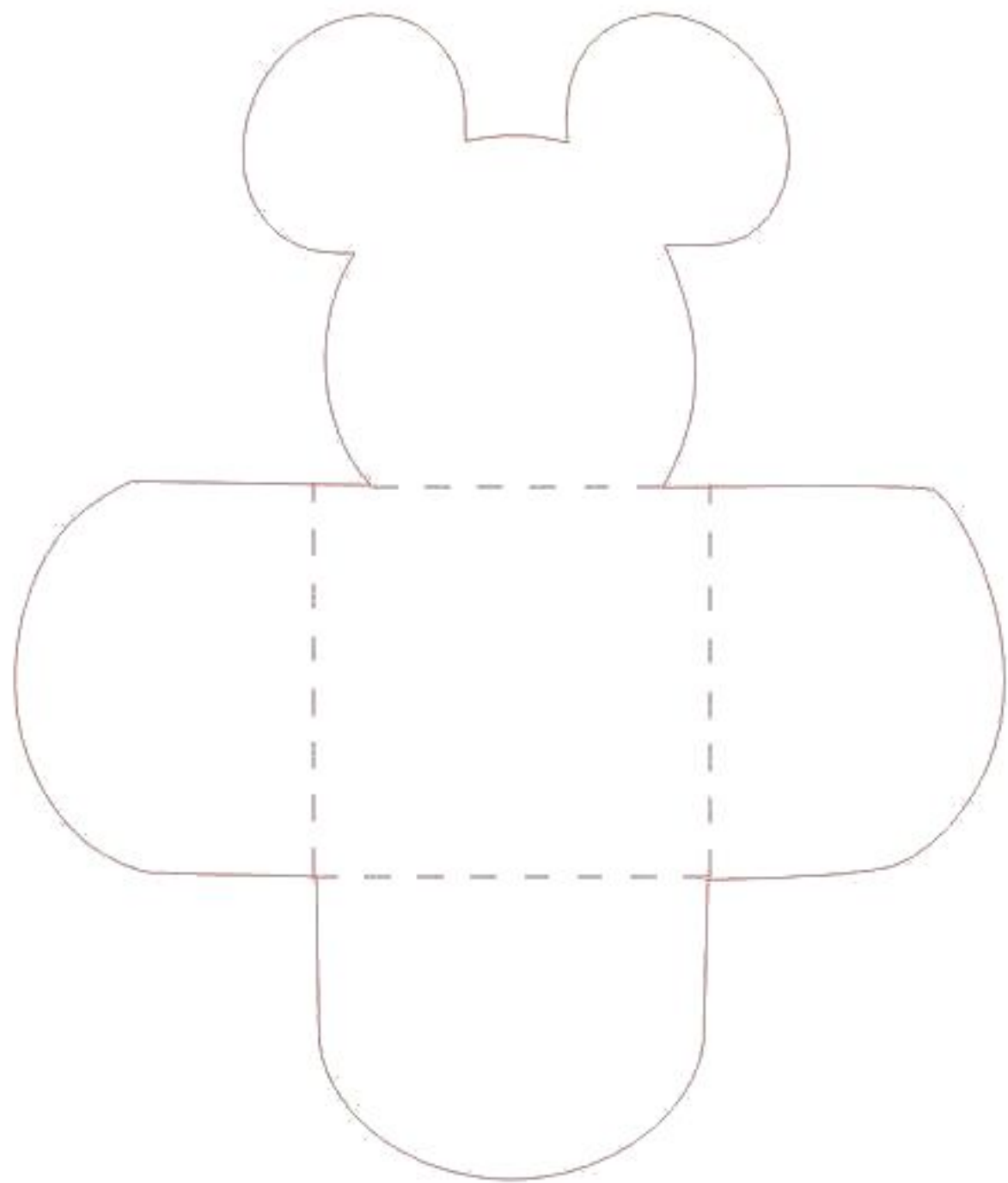

Линия
сгиба

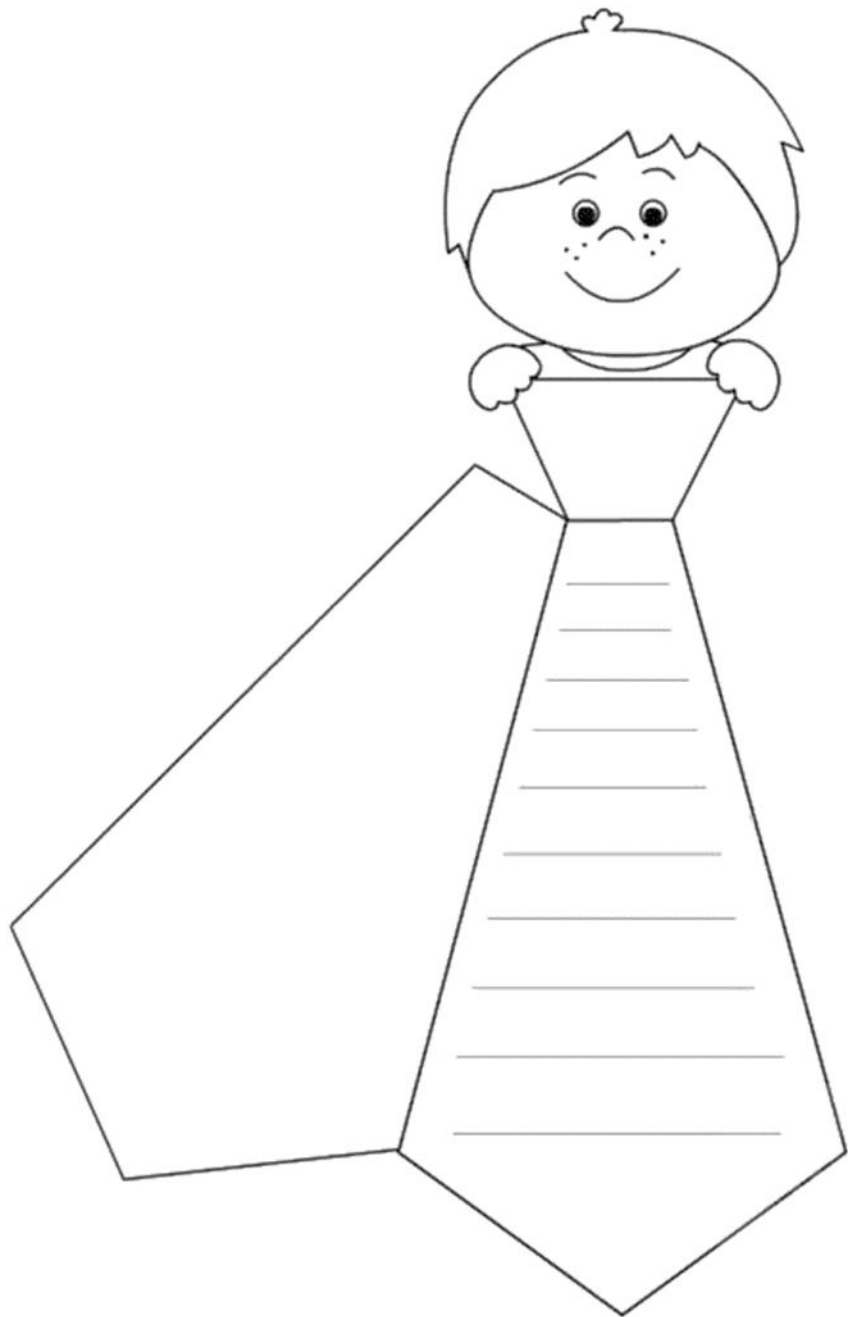
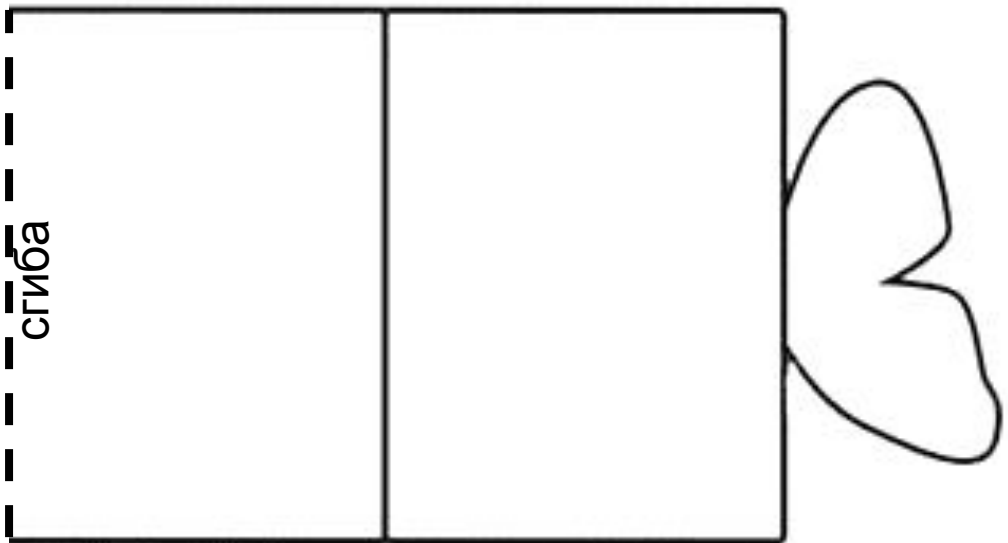



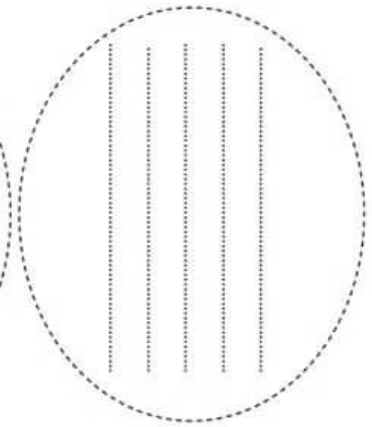
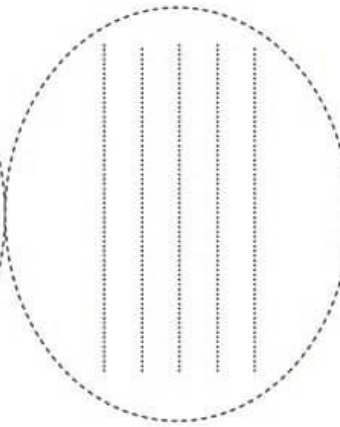
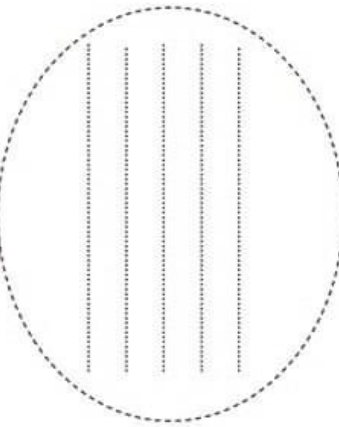

Cute Class Teacher PLODY



